



## CARATTERISTICHE

### MAJESTIC

Majestic è il gruppo cottura studiato appositamente per i veri appassionati di gastronomia, per chi desidera circondarsi solo di cose belle fatte bene. Esteticamente è un vero gioiello, prezioso, ricercato, un pezzo da collezione per arredare con eleganza l'ambiente cucina.

Tecnicamente si avvale di componenti di primissima qualità, di materiali resistenti, inalterabili e tradizionalmente puri quali acciaio inox, ghisa e ottone. Curato nei più piccoli particolari con l'attenzione e l'amore che solo ILVE può riservare ai suoi pezzi, necessita di tempi di realizzazione leggermente più lunghi ma certamente giustificati come si conviene ad ogni capolavoro. Majestic interpreta ogni esigenza di spazio, proponendosi con una vastissima gamma di soluzioni diversificate in dimensioni, colori e allestimenti.

I piani cottura, a sistema modulare, propongono bruciatori a gas diversificati con potenza da 1,8 a 4,3 kW, Fry Top a gas con spessa piastra in acciaio inox, piastra Coup de Feu in ghisa con anelli, barbecue elettrico con pietra lavica, piastra elettrica in vetroceramica. Non solo bella ed elegante: Majestic è una cucina moderna, tecnologica, intelligente e funzionale.

#### TUTTA LA LINEA "MAJESTIC" È FORNITA DI SERIE CON:

- \* Robuste griglie in ghisa
- \* Accensione elettrica integrata sulle manopole
- \* Cassetto scaldapiatti
- \* Porta fredda con triplo vetro
- \* Bruciatore Dual 0,3 - 5 kW
- \* Valvolatura di sicurezza sui fuochi
- \* Pannelli autopulenti su tutti i forni
- \* Ventilazione tangenziale
- \* Programmatore elettronico con sonda (solo mod. E3)
- \* Controllo elettronico della temperatura (forni elettrici MOD...E3)

## CONTROLLO ELETTRONICO DELLA TEMPERATURA (MOD. E3) 300°C

Il controllo elettronico del forno consente di ridurre drasticamente la differenza tra temperatura impostata e temperatura selezionata.

In questo modo si ottiene una più accurata e costante temperatura di cottura per performance da veri professionisti.

È possibile regolare la temperatura del forno già a partire dai 30°C, ottenendo la vera funzione scongelamento, e poi su fino ad arrivare ai 300°C per cuocere in modo perfetto pizze e focacce.

Con la nuova elettronica E3 inoltre è possibile programmare entrambi i forni in modo completamente indipendente.

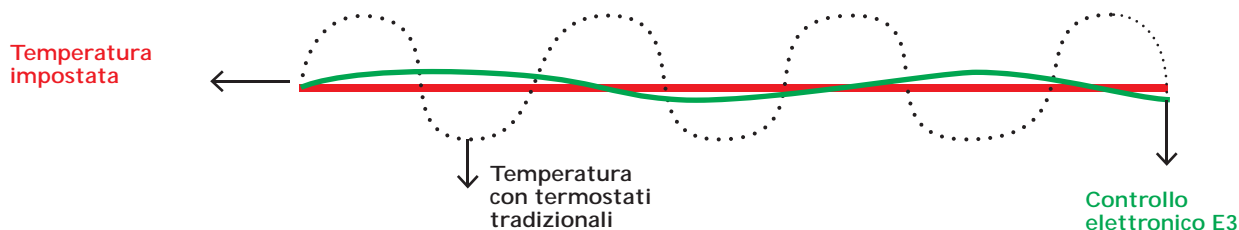



**PARTICOLARE PIANO ARROTONDATO**

Oltre a dare un'estetica innovativa e piacevole compensa la differenza tra la profondità dei mobili e della cucina evitando così l'impatto tra le due profondità.



**CASSETTO SCALDAPIAZZI**

Ideale per scaldare i piatti quando il forno è in uso



BRUCIATORE DUAL DI SERIE 5kW

MINIMO 0,3kW

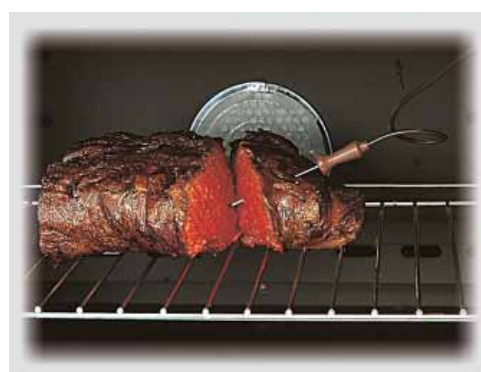

**PROGRAMMATORE ELETTRONICO CON SONDA**  
(disponibile solo nei modelli E3). Interrompe automaticamente la cottura quando la pietanza è cotta.



## GAMMA COLORI



VERDE SMERALDO



ROSSO BORGOGNA



GRAFITE



BLU



INOX



BIANCO ANTICO



BIANCO



PIEDINO OTTONE

MANOPOLE E MANIGLIONE IN OTTONE DI SERIE



PIEDINO INOX

MANOPOLE E MANIGLIONE CROMATI A RICHIESTA SENZA SOVRAPPREZZO

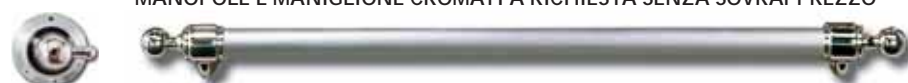

PIEDINO BRUNITO

MANOPOLE E MANIGLIONE BRUNITI A RICHIESTA CON SOVRAPPREZZO



PIEDINO INOX  
Altezza da 10 a 16 cm

MANOPOLE E MANIGLIONE IN ACCIAIO INOX (solo TECHNO)



PIEDINI  
CROMO / OTTONE / BRUNITI  
Altezza 15 cm

VEDI LISTA ACCESSORI NELLA PARTE INIZIALE DEL CATALOGO.

## CARATTERISTICHE TECNICHE:

Forno multifunzione 60: • classe energetica **A** • termostato • grill elettrico • programmatore elettronico.

Forno a gas ventilato 60: • termostato con termocoppia • grill elettrico • programmatore elettronico per funzioni grill e grill ventilato.

Tutti i modelli sono dotati di porta fredda a triplo vetro.

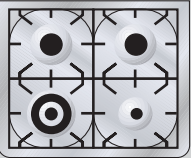
Tipologia piano cottura	Tipologia forno	Codice modello	Prezzo €
4 fuochi 	Multifunzione	<b>MT-70D-E3</b>	
	A gas ventilato	<b>MT-70D-VG</b>	

GAMMA COLORI		
		
Inox	Grafite-Mat	Bianco Antico
		
Rossoborgogna	Blu	Verdesmeraldo
		
Bianco		
PIANO DI LAVORO INOX		

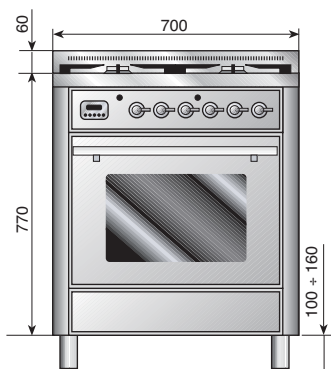

PROFONDITÀ 70







## CARATTERISTICHE TECNICHE:

Forno multifunzione 60: • classe energetica **A** • termostato • grill elettrico • programmatore elettronico.

Forno a gas ventilato 60: • termostato con termocoppia • grill elettrico • programmatore elettronico per funzioni grill e grill ventilato.

Tutti i modelli sono dotati di porta fredda a triplo vetro.

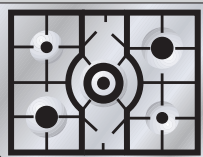

Tipologia piano cottura	Tipologia forno	Codice modello	Prezzo €
5 fuochi 	Multifunzione	<b>MT-76D-E3</b>	
	A gas ventilato	<b>MT-76D-VG</b>	



**GAMMA COLORI**

Inox	Grafite-Mat	Bianco Antico
Rosso borgogna	Blu	Verdesmeraldo
Bianco		

**PIANO DI LAVORO INOX**

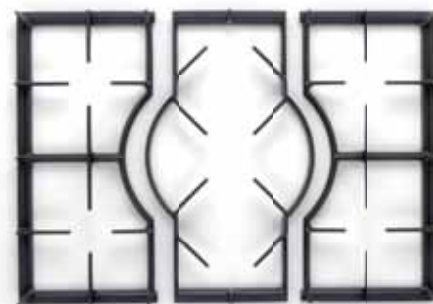

PROFONDITÀ 70









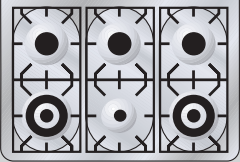
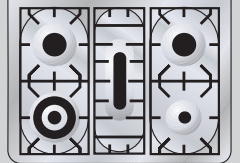
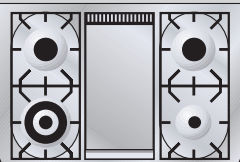

## CARATTERISTICHE TECNICHE:

Forno multifunzione 90: • classe energetica **A** • termostato • grill elettrico • girarrosto • programmatore elettronico.

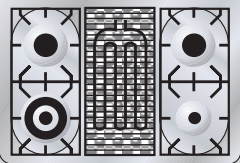
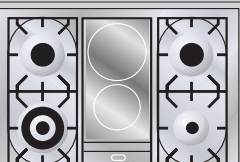
Forno a gas ventilato 90: • termostato con termocoppia • grill elettrico • girarrosto • programmatore elettronico per funzioni grill e grill ventilato.

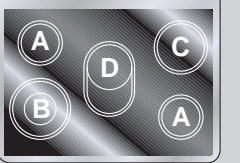
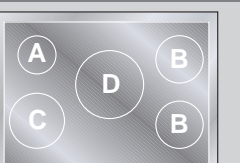
Tutti i modelli sono dotati di porta fredda a triplo vetro.

Tipologia piano cottura	Tipologia forno	Codice modello	Prezzo €
<b>6 fuochi</b> 	Multifunzione	<b>MT-906D-E3</b>	
	A gas ventilato	<b>MT-906D-VG</b>	
<b>Pescera</b> 	Multifunzione	<b>MT-90PD-E3</b>	
	A gas ventilato	<b>MT-90PD-VG</b>	
<b>Fry-Top</b> 	Multifunzione	<b>MT-90FD-E3</b>	
	A gas ventilato	<b>MT-90FD-VG</b>	
<b>Friggitrice</b> 	Multifunzione	<b>MT-90RD-E3</b>	
	A gas ventilato	<b>n.d.</b>	
<b>Barbecue</b> 	Multifunzione	<b>MT-90BD-E3</b>	
	A gas ventilato	<b>MT-90BD-VG</b>	
<b>2 Zone Induzione</b> 	 Multifunzione	<b>MT-90ID-E3</b>	2 x 1850 W
		Optional Fry Top G/419/08	
<b>Vetroceramica</b> 	Multifunzione	<b>MTE-90-E3</b>	
	A - ø 145 mm - 1200W B - ø 210/120 mm - 2200W/750W C - ø 180 mm - 1800W D - ø 265/170 mm - 2400W/1500W		
<b>Induzione</b> 	Multifunzione	<b>MTI-90-E3</b>	
	 A - ø 145 mm - 1400W B - ø 180 mm - 1850W C - ø 210 mm - 2300W D - ø 260 mm - 2400W		

GAMMA COLORI		
		
Inox	Grafite-Mat	Bianco Antico
		
Rossoborgogna	Blu	Verdesmeraldo
		
Bianco		
PIANO DI LAVORO INOX		

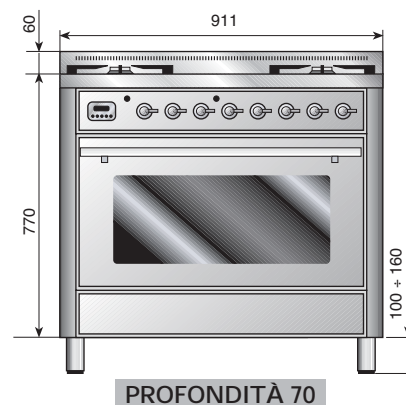





### CARATTERISTICHE TECNICHE:





Forno di sinistra: standard 60 in versione multifunzione o gas ventilato. Forno di destra: mini 30 elettrico statico.

Forno multifunzione 60: • classe energetica **A**; • termostato; • programmatore elettronico; • grill elettrico.

Mini forno elettrico 30: • classe energetica **A**; • grill elettrico; • girarrosto.

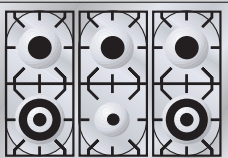
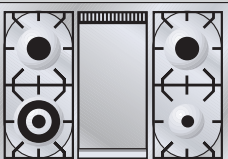
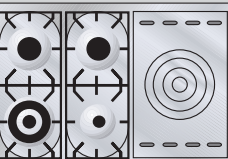
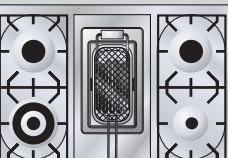
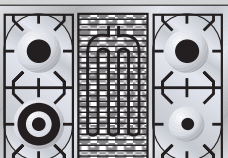
Forno a gas ventilato 60: • termostato con termocoppia; • grill elettrico; • programmatore elettronico.

**Tutti i modelli sono dotati di porta fredda a triplo vetro.**

Tipologia piano cottura	Tipologia forno	Codice modello	Prezzo €
<b>6 fuochi</b> 	Multifunzione	<b>MTD-1006D-E3</b>	
	A gas ventilato	<b>MTD-1006D-VG</b>	
<b>Fry-Top</b> 	Multifunzione	<b>MTD-100FD-E3</b>	
	A gas ventilato	<b>MTD-100FD-VG</b>	
<b>Coup De Feu</b> 	Multifunzione	<b>MTD-100SD-E3</b>	
	A gas ventilato	<b>MTD-100SD-VG</b>	
<b>Friggitrice</b> 	Multifunzione	<b>MTD-100RD-E3</b>	
	A gas ventilato	<b>n.d.</b>	
<b>Barbecue</b> 	Multifunzione	<b>MTD-100BD-E3</b>	
	A gas ventilato	<b>MTD-100BD-VG</b>	
<b>1 Zona vetroceramica</b> 	Multifunzione	<b>MTD-100VD-E3</b>	
	A gas ventilato	<b>MTD-100VD-VG</b>	
<b>Vetroceramica</b> 	Multifunzione	<b>MTDE-100-E3</b>	
			A - ø 145 mm - 1200W B - ø 210/120 mm - 2200W/750W C - ø 180 mm - 1800W D - ø 265/170 mm - 2400W/1500W
<b>Induzione</b> 	Multifunzione	<b>MTDI-100-E3</b>	
			A - ø 145 mm - 1400W B - ø 180 mm - 1850W C - ø 210 mm - 2300W

GAMMA COLORI		
		
Inox	Grafite-Mat	Bianco Antico
		
Rossoborgogna	Blu	Verdesmeraldo
		
Bianco		
PIANO DI LAVORO INOX		

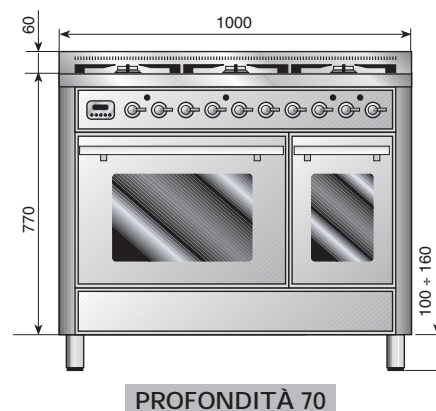





## CARATTERISTICHE TECNICHE:

Forno di sinistra: maxiforno 90 in versione multifunzione o gas ventilato. Forno di destra: mini 30 elettrico statico.

Maxiforno multifunzione 90: • classe energetica **A**; • termostato; • programmatore elettronico; • girarrosto; • grill elettrico.

MiniForno elettrico 30: • classe energetica **A**; • grill elettrico; • girarrosto.

Maxiforno a gas ventilato 90: • termostato con termocoppia; • grill elettrico; • programmatore elettronico.

Tutti i modelli sono dotati di porta fredda a triplo vetro.

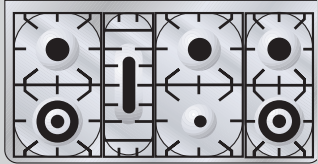
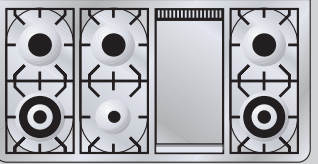
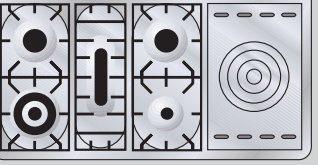
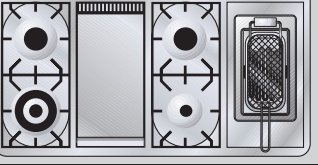
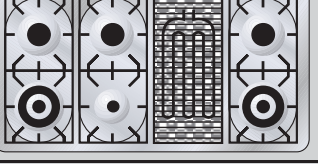
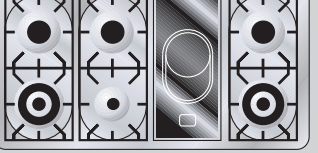
Tipologia piano cottura	Tipologia forno	Codice modello	Prezzo €
<b>7 fuochi</b> 	Multifunzione	<b>MT-1207D-E3</b>	
	A gas ventilato	<b>MT-1207D-VG</b>	
<b>Fry-Top</b> 	Multifunzione	<b>MT-120FD-E3</b>	
	A gas ventilato	<b>MT-120FD-VG</b>	
<b>Coup De Feu</b> 	Multifunzione	<b>MT-120SD-E3</b>	
	A gas ventilato	<b>MT-120SD-VG</b>	
<b>Friggitrice</b> 	Multifunzione	<b>MT-120FRD-E3</b>	
	A gas ventilato	<b>n.d.</b>	
<b>Barbecue</b> 	Multifunzione	<b>MT-120BD-E3</b>	
	A gas ventilato	<b>MT-120BD-VG</b>	
<b>1 Zona vetroceramica</b> 	Multifunzione	<b>MT-120VD-E3</b>	
	A gas ventilato	<b>MT-120VD-VG</b>	

GAMMA COLORI		
		
Inox	Grafite-Mat	Bianco Antico
		
Rossoborgogna	Blu	Verdesmeraldo
		
Bianco		
PIANO DI LAVORO INOX		

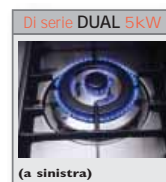

Maxiforno 90 cm

Mini 30 cm





### CARATTERISTICHE TECNICHE:

Forno di sinistra: standard 70 in versione multifunzione. Forno di destra: midi 40 elettrico statico.

Maxiforno multifunzione 70: • classe energetica **A**; • termostato; • programmatore elettronico; • grill elettrico.

Maxiforno a gas ventilato 70: • termostato con termocoppia • grill elettrico • girarrosto • programmatore elettronico.

Midi forno elettrico 40: • classe energetica **A**; • grill elettrico; • girarrosto.

Tutti i modelli sono dotati di porta fredda a triplo vetro.

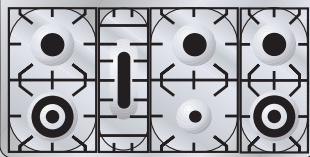
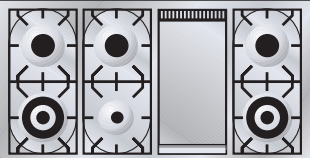
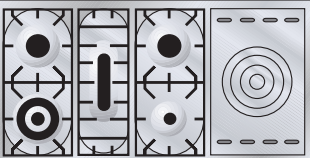
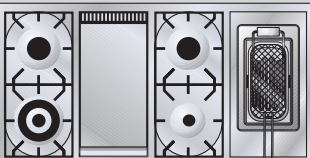
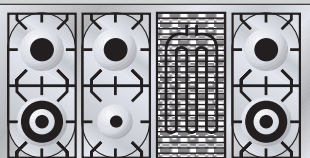
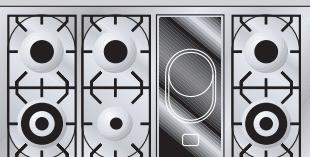
Tipologia piano cottura	Tipologia forno	Codice modello	Prezzo €
<b>7 fuochi</b> 	Multifunzione	<b>MTS-I207D-E3</b>	
	A gas ventilato	<b>MTS-I207D-VG</b>	
<b>Fry-Top</b> 	Multifunzione	<b>MTS-I20FD-E3</b>	
	A gas ventilato	<b>MTS-I20FD-VG</b>	
<b>Coup De Feu</b> 	Multifunzione	<b>MTS-I20SD-E3</b>	
	A gas ventilato	<b>MTS-I20SD-VG</b>	
<b>Friggitrice</b> 	Multifunzione	<b>MTS-I20FRD-E3</b>	
	A gas ventilato	<b>n.d.</b>	
<b>Barbecue</b> 	Multifunzione	<b>MTS-I20BD-E3</b>	
	A gas ventilato	<b>MTS-I20BD-VG</b>	
<b>1 Zona vetroceramica</b> 	Multifunzione	<b>MTS-I20VD-E3</b>	
	A gas ventilato	<b>MTS-I20VD-VG</b>	

**GAMMA COLORI**

		
Inox	Grafite-Mat	Bianco Antico
		
Rossoborgogna	Blu	Verdesmeraldo
		
Bianco		

**PIANO DI LAVORO INOX**



Forno 70 cm

Midi 40 cm







## CARATTERISTICHE TECNICHE:

Forno di sinistra: maxiforno 90 in versione multifunzione o gas ventilato. Forno di destra: standard 60 multifunzione.

Forno multifunzione 60: • classe energetica **A**; • termostato; • programmatore elettronico; • grill elettrico.

Maxiforno a gas ventilato 90: • termostato con termocoppia; • grill elettrico; • girarrosto.

Maxiforno multifunzione 90: • classe energetica **A**; • termostato; • grill elettrico; • girarrosto.

Tutti i modelli sono dotati di porta fredda a triplo vetro.

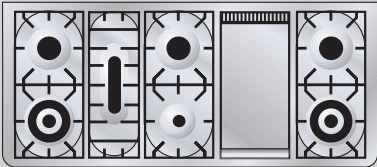
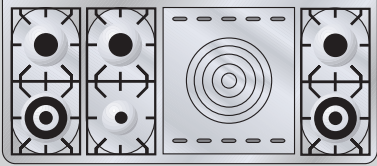
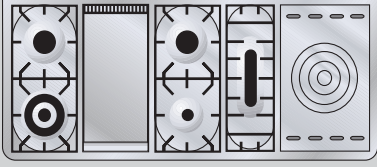
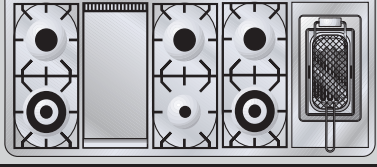
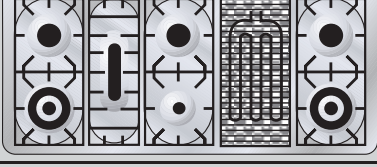
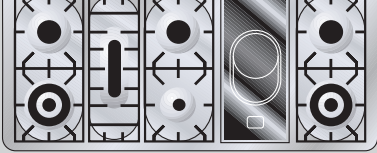
Tipologia piano cottura	Tipologia forno	Codice modello	Prezzo €
<b>Fry-Top</b> 	Multifunzione	<b>MT-I 50FD-E3</b>	
	A gas ventilato	<b>MT-I 50FD-VG</b>	
<b>Coup De Feu</b> 	Multifunzione	<b>MT-I 50SD-E3</b>	
	A gas ventilato	<b>MT-I 50SD-VG</b>	
<b>Fry-Top + Coup De Feu</b> 	Multifunzione	<b>MT-I 50FSD-E3</b>	
	A gas ventilato	<b>MT-I 50FSD-VG</b>	
<b>Friggitrice + Fry-Top</b> 	Multifunzione	<b>MT-I 50FRD-E3</b>	
	A gas ventilato	<b>n.d.</b>	
<b>Barbecue</b> 	Multifunzione	<b>MT-I 50BD-E3</b>	
	A gas ventilato	<b>MT-I 50BD-VG</b>	
<b>1 Zona vetroceramica</b> 	Multifunzione	<b>MT-I 50VD-E3</b>	
	A gas ventilato	<b>MT-I 50VD-VG</b>	

GAMMA COLORI		
		
Inox	Grafite-Mat	Bianco Antico
		
Rossoborgogna	Blu	Verdesmeraldo
		
Bianco		
PIANO DI LAVORO INOX		



Maxiforno 90 cm

Standard 60 cm

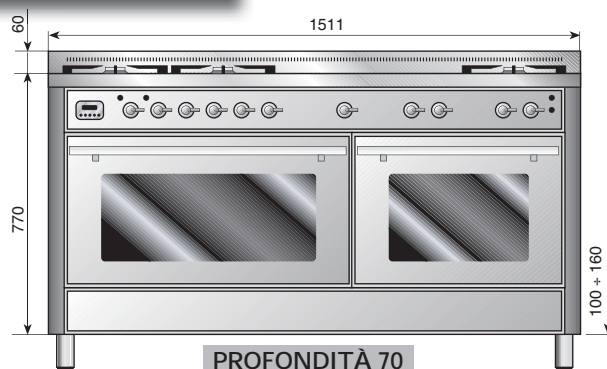





## CARATTERISTICHE TECNICHE:

Forno multifunzione 60: • classe energetica **A**; • termostato • grill elettrico • programmatore elettronico.

Forno a gas ventilato 60: • termostato con termocoppia • grill elettrico • programmatore elettronico per funzioni grill e grill ventilato.

Tutti i modelli sono dotati di porta fredda a triplo vetro.

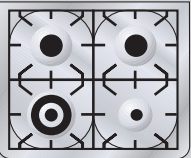
Tipologia piano cottura	Tipologia forno	Codice modello	Fin. Ottone/Cromo €	Fin. Brunite €
4 fuochi 	Multifunzione	<b>M-70D-E3</b>		
	A gas ventilato	<b>M-70D-VG</b>		

GAMMA COLORI		
Inox	Grafite-Mat	Bianco Antico
Rossoborgogna	Blu	Verdesmeraldo
Bianco		
PIANO DI LAVORO INOX		



FINITURE	
<b>OTTONE (di serie)</b>	
<b>CROMO (a richiesta senza sovrapprezzo)</b>	
<b>BRUNITE (a richiesta con sovrapprezzo)</b>	

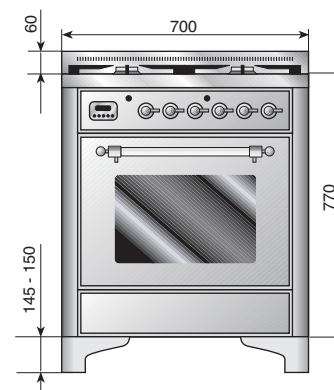

PROFONDITÀ 70



## CARATTERISTICHE TECNICHE:

Maxiforno multifunzione 70: • classe energetica **A**; • termostato • programmatore elettronico • grill elettrico.

Maxiforno a gas ventilato 70: • termostato con termocoppia • grill elettrico • programmatore elettronico per funzioni grill e grill ventilato.

Tutti i modelli sono dotati di porta fredda a triplo vetro.



Tipologia piano cottura	Tipologia forno	Codice modello	Fin. Ottone/Cromo€	Fin. Brunite€
5 fuochi 	Multifunzione	<b>M-76D-E3</b>		
	A gas ventilato	<b>M-76D-VG</b>		

### GAMMA COLORI

Inox	Grafite-Mat	Bianco Antico
Rossoborgogna	Blu	Verdesmeraldo
Bianco		

**PIANO DI LAVORO INOX**



### FINITURE

  
**OTTONE (di serie)**

  
**CROMO**  
(a richiesta senza sovrapprezzo)

  
**BRUNITE**  
(a richiesta con sovrapprezzo)

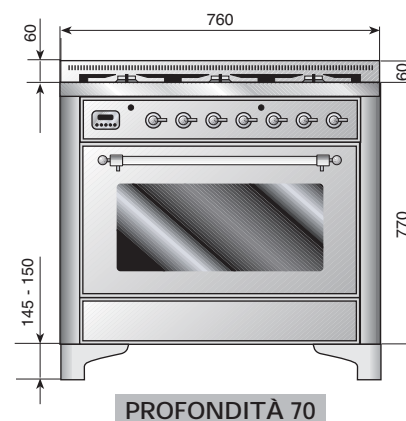
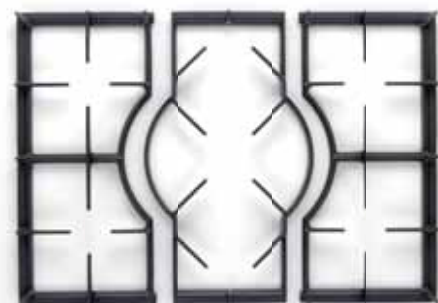











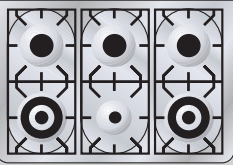
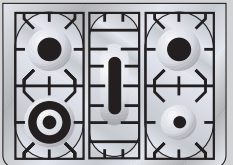
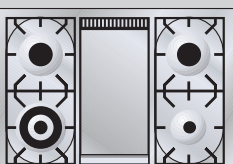

## CARATTERISTICHE TECNICHE:

Maxiforno multifunzione 90: • classe energetica **A**; • termostato; • grill elettrico; • programmatore elettronico.

Maxiforno a gas ventilato 90: • termostato con termocoppia; • grill elettrico; • girarrosto; • programmatore elettronico per funzioni grill e grill ventilato.

Tutti i modelli sono dotati di porta fredda a triplo vetro.

Tipologia piano cottura	Tipologia forno	Codice modello	Fin. Ottone/Cromo €	Fin. Brunite €
<b>6 fuochi</b> 	Multifunzione	<b>M-906D-E3</b>		
	A gas ventilato	<b>M-906D-VG</b>		
<b>Pescera</b> 	Multifunzione	<b>M-90PD-E3</b>		
	A gas ventilato	<b>M-90PD-VG</b>		
<b>Fry-Top</b> 	Multifunzione	<b>M-90FD-E3</b>		
	A gas ventilato	<b>M-90FD-VG</b>		
<b>Friggitrice</b> 	Multifunzione	<b>M-90RD-E3</b>		
	A gas ventilato	<b>n.d.</b>		
<b>Barbecue</b> 	Multifunzione	<b>M-90BD-E3</b>		
	A gas ventilato	<b>M-90BD-VG</b>		
<b>2 Zone Induzione</b> 	 Multifunzione	<b>M-901D-E3</b>		
		Optional Fry Top G/419/08 2 x 1850 W		
<b>Vetroceramica</b> 	Multifunzione	<b>ME-90-E3</b>		
A - ø 145 mm - 1200W B - ø 210/120 mm - 2200W/750W C - ø 180 mm - 1800W D - ø 265/170 mm - 2400W/1500W				
<b>Induzione</b> 	Multifunzione	<b>MI-90-E3</b>		
		A - ø 145 mm - 1400W B - ø 180 mm - 1850W C - ø 210 mm - 2300W D - ø 260 mm - 2400W 		

GAMMA COLORI		
		
Inox	Grafite-Mat	Bianco Antico
		
Rossoborgogna	Blu	Verdesmeraldo
	Consegna 60 gg. lavorativi	
Bianco		

**PIANO DI LAVORO INOX**

FINITURE	
	
<b>OTTONE (di serie)</b>	
	
<b>CROMO (a richiesta senza sovrapprezzo)</b>	
	
<b>BRUNITE (a richiesta con sovrapprezzo)</b>	

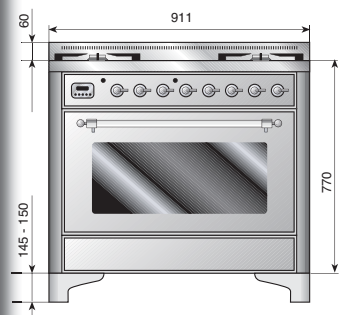

**PROFONDITÀ 70**







**CARATTERISTICHE TECNICHE:**





Forno di sinistra: standard 60 in versione multifunzione o gas ventilato. Forno di destra: mini 30 elettrico statico.

Forno multifunzione 60: • classe energetica **A**; • termostato; • programmatore elettronico; • grill elettrico.

Mini forno elettrico 30: • classe energetica **A**; • grill elettrico; • girarrosto.

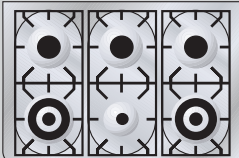
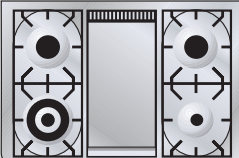
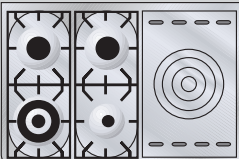
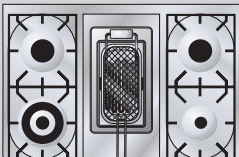
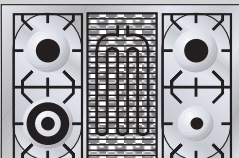
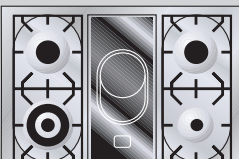
Forno a gas ventilato 60: • termostato con termocoppia; • grill elettrico; • programmatore elettronico.

Tutti i modelli sono dotati di porta fredda a triplo vetro.

Tipologia piano cottura	Tipologia forno	Codice modello	Fin. Ottone/ Cromo €	Fin. Brunite €
<b>6 fuochi</b> 	Multifunzione	<b>MD-1006D-E3</b>		
	A gas ventilato	<b>MD-1006D-VG</b>		
<b>Fry-Top</b> 	Multifunzione	<b>MD-100FD-E3</b>		
	A gas ventilato	<b>MD-100FD-VG</b>		
<b>Coup De Feu</b> 	Multifunzione	<b>MD-100SD-E3</b>		
	A gas ventilato	<b>MD-100SD-VG</b>		
<b>Friggitrice</b> 	Multifunzione	<b>MD-100RD-E3</b>		
	A gas ventilato	<b>n.d.</b>		
<b>Barbecue</b> 	Multifunzione	<b>MD-100BD-E3</b>		
	A gas ventilato	<b>MD-100BD-VG</b>		
<b>1 Zona vetroceramica</b> 	Multifunzione	<b>MD-100VD-E3</b>		
	A gas ventilato	<b>MD-100VD-VG</b>		
<b>Vetroceramica</b> 	Multifunzione	<b>MDE-100-E3</b>		
	A - ø 145 mm - 1200W B - ø 210/120 mm - 2200W/750W C - ø 180 mm - 1800W D - ø 265/170 mm - 2400W/1500W			
<b>Induzione</b> 	Multifunzione	<b>MDI-100-E3</b>		
	A - ø 145 mm - 1400W B - ø 180 mm - 1850W C - ø 210 mm - 2300W			

**GAMMA COLORI**

		
Inox	Grafite-Mat	Bianco Antico
		
Rosso borgogna	Blu	Verdesmeraldo
		
Bianco		

**PIANO DI LAVORO INOX**

**FINITURE**

	
<b>OTTONE (di serie)</b>	
	
<b>CROMO (a richiesta senza sovrapprezzo)</b>	
	
<b>BRUNITE (a richiesta con sovrapprezzo)</b>	

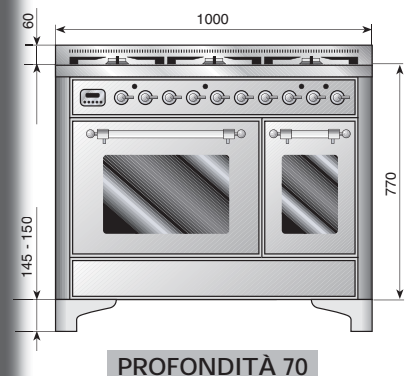



## CARATTERISTICHE TECNICHE:

Forno di sinistra: maxiforno 90 in versione multifunzione o gas ventilato. Forno di destra: mini 30 elettrico statico.

Maxiforno multifunzione 90: • classe energetica **A**; • termostato; • programmatore elettronico; • girarrosto; • grill elettrico.

MiniForno elettrico 30: • classe energetica **A**; • grill elettrico; • girarrosto.

Maxiforno a gas ventilato 90: • termostato con termocoppia; • grill elettrico; • programmatore elettronico.

Tutti i modelli sono dotati di porta fredda a triplo vetro.

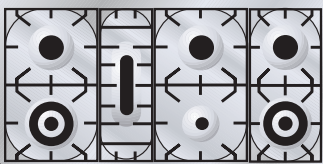
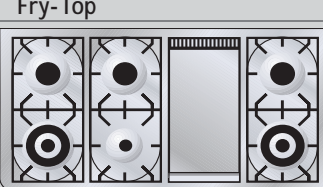
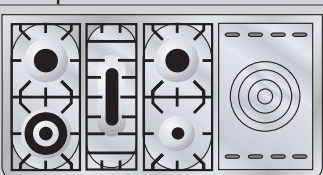
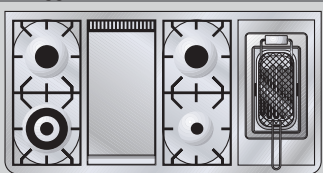
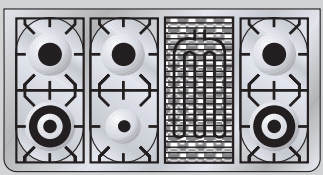
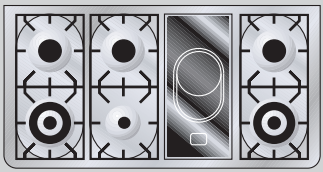
Tipologia piano cottura	Tipologia forno	Codice modello	Finiture Ottone/Cromo€	Fin. Brunite€
<b>7 fuochi</b> 	Multifunzione	<b>M-1207D-E3</b>		
	Agas ventilato	<b>M-1207D-VG</b>		
<b>Fry-Top</b> 	Multifunzione	<b>M-120FD-E3</b>		
	Agas ventilato	<b>M-120FD-VG</b>		
<b>Coup De Feu</b> 	Multifunzione	<b>M-120SD-E3</b>		
	Agas ventilato	<b>M-120SD-VG</b>		
<b>Friggitrice</b> 	Multifunzione	<b>M-120FRD-E3</b>		
	Agas ventilato	<b>n.d.</b>		
<b>Barbecue</b> 	Multifunzione	<b>M-120BD-E3</b>		
	Agas ventilato	<b>M-120BD-VG</b>		
<b>1 Zona vetroceramica</b> 	Multifunzione	<b>M-120VD-E3</b>		
	Agas ventilato	<b>M-120VD-VG</b>		

GAMMA COLORI		
		
Inox	Graffite-Mat	Bianco Antico
		
Rosso borgogna	Blu	Verdesmeraldo
		
Bianco		

PIANO DI LAVORO INOX

FINITURE	
	
OTTONE (di serie)	
	
CROMO (a richiesta senza sovrapprezzo)	
	
BRUNITE (a richiesta con sovrapprezzo)	



Maxiforno 90 cm

Mini 30 cm

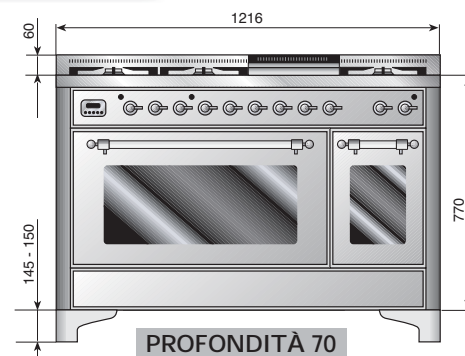





## CARATTERISTICHE TECNICHE:

Forno di sinistra: maxiforno 70 in versione multifunzione. Forno di destra: midi 40 elettrico statico.

Maxiforno multifunzione 70: • classe energetica **A**; • termostato; • programmatore elettronico; • girarrosto; • grill elettrico.

Maxiforno a gas ventilato 70: • termostato con termocoppia • grill elettrico • girarrosto • programmatore elettronico.

MidiForno elettrico 40: • classe energetica **A**; • grill elettrico; • girarrosto.

Tutti i modelli sono dotati di porta fredda a triplo vetro.

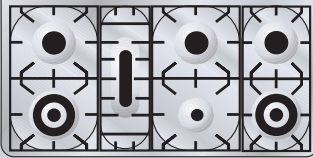
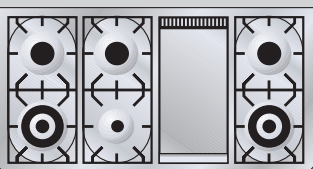
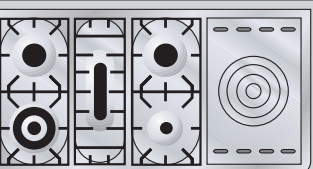
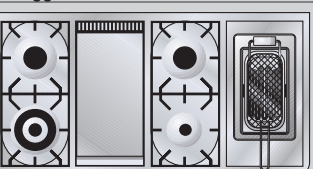
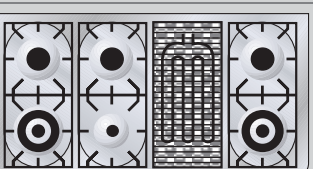
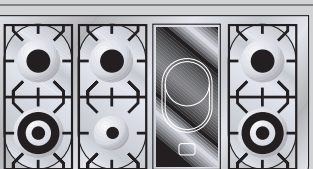
Tipologia piano cottura	Tipologia forno	Codice modello	Finiture Ottone/Cromo€	Fin. Brunite€
<b>7 fuochi</b> 	Multifunzione	<b>MS-I207D-E3</b>		
	Agasventilato	<b>MS-I207D-VG</b>		
<b>Fry-Top</b> 	Multifunzione	<b>MS-I20FD-E3</b>		
	Agasventilato	<b>MS-I20FD-VG</b>		
<b>Coup De Feu</b> 	Multifunzione	<b>MS-I20SD-E3</b>		
	Agasventilato	<b>MS-I20SD-VG</b>		
<b>Friggitrice</b> 	Multifunzione	<b>MS-I20FRD-E3</b>		
	Agasventilato	<b>n.d.</b>		
<b>Barbecue</b> 	Multifunzione	<b>MS-I20BD-E3</b>		
	Agasventilato	<b>MS-I20BD-VG</b>		
<b>1 Zona vetroceramica</b> 	Multifunzione	<b>MS-I20VD-E3</b>		
	Agasventilato	<b>MS-I20VD-VG</b>		

GAMMA COLORI		
		
Inox	Graffite-Mat	Bianco Antico
		
Rossoborgogna	Blu	Verdesmeraldo
		
Bianco		

**PIANO DI LAVORO INOX**

FINITURE	
	
<b>OTTONE (di serie)</b>	
	
<b>CROMO (a richiesta senza sovrapprezzo)</b>	
	
<b>BRUNITE (a richiesta con sovrapprezzo)</b>	



Forno 70 cm

Midi 40 cm









## CARATTERISTICHE TECNICHE:

Forno di sinistra: maxiforno 90 in versione multifunzione o gas ventilato. Forno di destra: standard 60 multifunzione.

Forno multifunzione 60: • classe energetica **A**; • termostato; • programmatore elettronico; • grill elettrico.

Maxiforno a gas ventilato 90: • termostato con termocoppia; • grill elettrico; • girarrosto.

Maxiforno multifunzione 90: • classe energetica **A**; • termostato; • grill elettrico; • girarrosto.

Tutti i modelli sono dotati di porta fredda a triplo vetro.

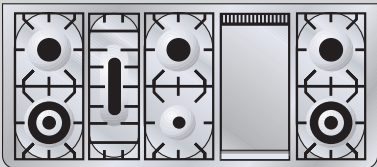
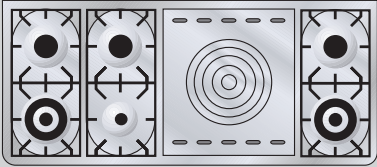
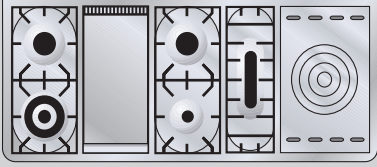
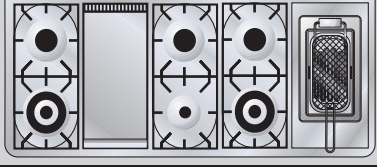
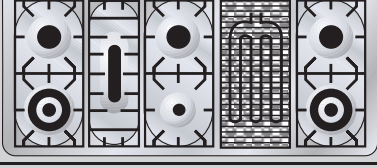
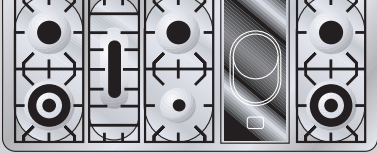
Tipologia piano cottura	Tipologia forno	Codice modello	Finiture Ottone Cromo €	Finiture Brunite €
<b>Fry-Top</b> 	Multifunzione	<b>M-I50FD-E3</b>		
	Agas ventilato	<b>M-I50FD-VG</b>		
<b>Coup De Feu</b> 	Multifunzione	<b>M-I50SD-E3</b>		
	Agas ventilato	<b>M-I50SD-VG</b>		
<b>Fry-Top + Coup De Feu</b> 	Multifunzione	<b>M-I50FSD-E3</b>		
	Agas ventilato	<b>M-I50FSD-VG</b>		
<b>Friggitrice + Fry-Top</b> 	Multifunzione	<b>M-I50FRD-E3</b>		
	Agas ventilato	<b>n.d.</b>		
<b>Barbecue</b> 	Multifunzione	<b>M-I50BD-E3</b>		
	Agas ventilato	<b>M-I50BD-VG</b>		
<b>1 Zona vetroceramica</b> 	Multifunzione	<b>M-I50VD-E3</b>		
	Agas ventilato	<b>M-I50VD-VG</b>		

### GAMMA COLORI



Inox      Grafite-Mat      Bianco Antico

Rossoborgogna      Blu      Verdesmeraldo

Bianco

PIANO DI LAVORO INOX

### FINITURE



**OTTONE** (di serie)

**CROMO** (a richiesta senza sovrapprezzo)

**BRUNITE** (a richiesta con sovrapprezzo)

Di serie DUAL 5kW



(a sinistra)



Maxiforno 90 cm

Standard 60 cm

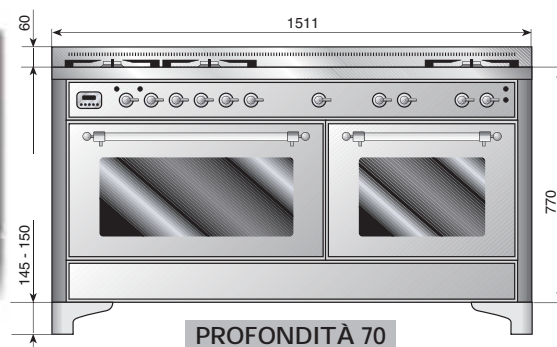





# FINITURE

# Majestic Country



MANOPOLE E MANIGLIONE IN OTTONE DI SERIE



MANOPOLE E MANIGLIONE CROMATI A RICHIESTA SENZA SOVRAPPREZZO



MANOPOLE E MANIGLIONE CROMATI A RICHIESTA CON SOVRAPPREZZO



PIEDINO SPECIALE E POMELLI SU CASSETTO



CORRIMANO FRONTALE



PROGRAMMATORE ELETTRONICO CON SONDA (disponibile solo nei modelli E3). Interrompe automaticamente la cottura quando la pietanza è cotta.

# OPTIONALS

Disponibile con porta:



MC= COUNTRY



MCA= ANTIQUA

# GRUPPO DI COTTURA MC-70

CARATTERISTICHE TECNICHE:

Forno multifunzione 60: • classe energetica **A**; • termostato; • grill elettrico; • programmatore elettronico.

Forno a gas ventilato 60: • termostato con termocoppia; • grill elettrico; • programmatore elettronico per funzioni grill e grill ventilato

## GAMMA COLORI

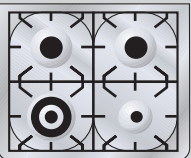

Piani di lavoro INOX

Tipologia piano cottura	Tipologia forno	Codice modello	Fin. Ottone/Cromo €	Fin. Brunite €
4 fuochi 	Multifunzione	<b>MC-70D-E3</b> <b>MCA-70D-E3</b>		
	A gas ventilato	<b>MC-70D-VG</b> <b>MCA-70D-VG</b>		

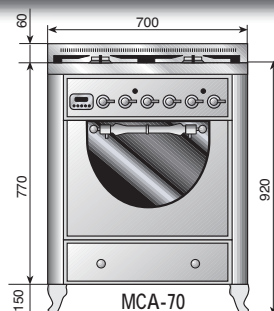
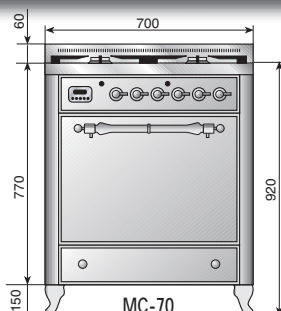

PROFONDITÀ 70



MC-70D-E3/VSX





## CARATTERISTICHE TECNICHE:

Maxiforno multifunzione 70: • classe energetica **A**; • termostato • programmatore elettronico • grill elettrico.

Maxiforno a gas ventilato 70: • termostato con termocoppia; • grill elettrico; • girarrosto; • programmatore elettronico per funzioni grill e grill ventilato.

Tutti i modelli sono dotati di porta fredda a triplo vetro.

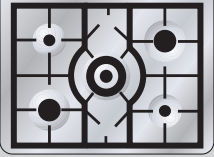
Tipologia piano cottura	Tipologia forno	Codice modello	Fin. Ottone/Cromo €	Fin. Brunite €
5 fuochi 	Multifunzione	<b>MC-76D-E3</b> <b>MCA-76D-E3</b>		
	A gas ventilato	<b>MC-76D-VG</b> <b>MCA-76D-VG</b>		

**GAMMA COLORI**

Inox	Grafite-Mat	Bianco Antico
Rossoborgogna	Blu	Verdesmeraldo
Bianco		

**PIANO DI LAVORO INOX**

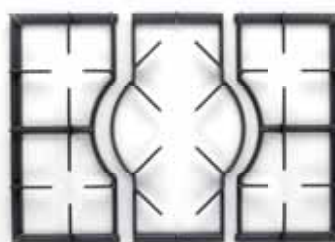

**FINITURE**

  
**OTTONE (di serie)**

  
**CROMO**  
(a richiesta senza sovrapprezzo)

  
**BRUNITE**  
(a richiesta con sovrapprezzo)





MC-76D-E3/MAT

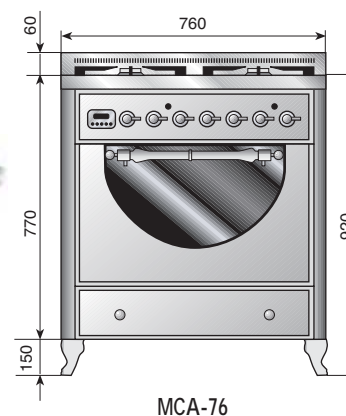
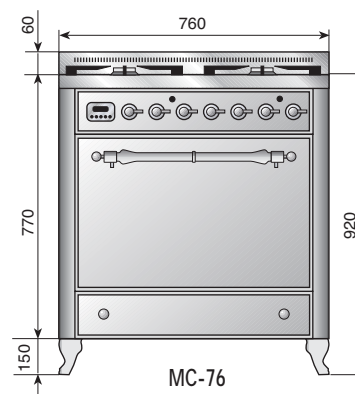

PROFONDITÀ 70











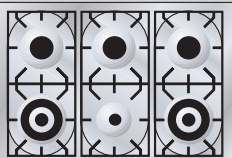
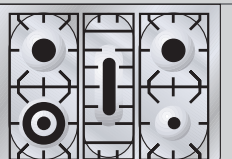

## CARATTERISTICHE TECNICHE:

Forno multifunzione 90: • classe energetica **A**; • termostato; • grill elettrico; • programmatore elettronico.

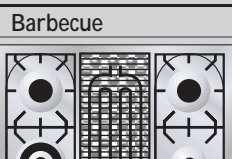
Forno a gas ventilato 90: • termostato con termocoppia; • grill elettrico; • girarrosto; • programmatore elettronico per funzioni grill e grill ventilato.

Tutti i modelli sono dotati di porta fredda a triplo vetro.

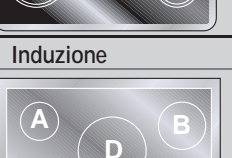
Tipologia piano cottura	Tipologia forno	Codice modello	Fin. Ottone/Cromo€	Fin. Brunite€
<b>6 fuochi</b> 	Multifunzione	<b>MC-906D-E3</b> <b>MCA-906D-E3</b>		
	A gas ventilato	<b>MC-906D-VG</b> <b>MCA-906D-VG</b>		
<b>Pescera</b> 	Multifunzione	<b>MC-90PD-E3</b> <b>MCA-90PD-E3</b>		
	A gas ventilato	<b>MC-90PD-VG</b> <b>MCA-90PD-VG</b>		
<b>Fry-Top</b> 	Multifunzione	<b>MC-90FD-E3</b> <b>MCA-90FD-E3</b>		
	A gas ventilato	<b>MC-90FD-VG</b> <b>MCA-90FD-VG</b>		
<b>Friggitrice</b> 	Multifunzione	<b>MC-90RD-E3</b> <b>MCA-90RD-E3</b>		
	A gas ventilato	<b>n.d.</b>		
<b>Barbecue</b> 	Multifunzione	<b>MC-90BD-E3</b> <b>MCA-90BD-E3</b>		
	A gas ventilato	<b>MC-90BD-VG</b> <b>MCA-90BD-VG</b>		
<b>2 Zone Induzione</b> 	Multifunzione	<b>MC-90ID-E3</b> <b>MCA-90ID-E3</b>		
		<b>Optional Fry Top G/419/08</b> 2 x 1850 W 		
<b>Vetroceramica</b> 	Multifunzione	<b>MCE-90-E3</b> <b>MCAE-90-E3</b>		
		A - ø 145 mm - 1200W B - ø 210/120 mm - 2200W/750W C - ø 180 mm - 1800W D - ø 265/170 mm - 2400W/1500W		
<b>Induzione</b> 	Multifunzione	<b>MCI-90-E3</b> <b>MCAI-90-E3</b>		
		A - ø 145 mm - 1400W B - ø 180 mm - 1850W C - ø 210 mm - 2300W D - ø 260 mm - 2400W		

GAMMA COLORI		
		
Inox	Grafite-Mat	Bianco Antico
		
Rossoborgogna	Blu	Verdesmeraldo
		
Bianco		
PIANO DI LAVORO INOX		

FINITURE	
	
<b>OTTONE</b> (di serie)	
	
<b>CROMO</b> (a richiesta senza sovrapprezzo)	
	
<b>BRUNITE</b> (a richiesta con sovrapprezzo)	

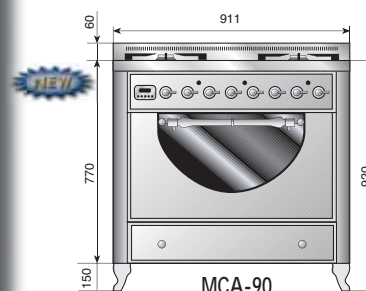
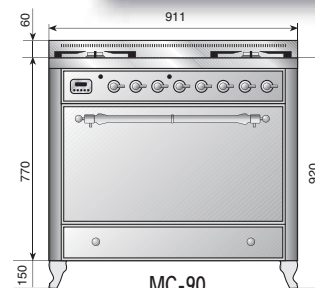

MC-90RD-E3/M  
PROFONDITÀ 70



## CARATTERISTICHE TECNICHE:





Forno di sinistra: standard 60 in versione multifunzione o gas ventilato. Forno di destra: mini 30 elettrico statico.

Forno multifunzione 60: • classe energetica **A**; • termostato; • programmatore elettronico; • grill elettrico.

Mini forno elettrico 30: • classe energetica **A**; • grill elettrico; • girarrosto.

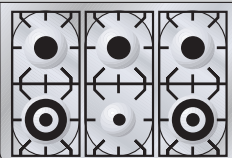
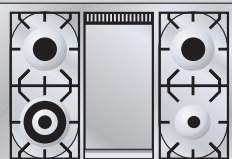
Forno a gas ventilato 60: • termostato con termocoppia; • grill elettrico; • programmatore elettronico.

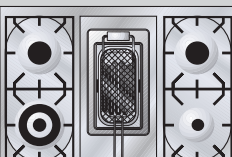
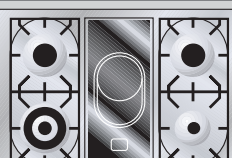
**Tutti i modelli sono dotati di porta fredda a triplo vetro.**

Tipologia piano cottura	Tipologia forno	Codice modello	Fin. Ottone/Cromo €	Fin. Brunite €
<b>6 fuochi</b> 	Multifunzione	<b>MCD-1006D-E3</b>		
	A gas ventilato	<b>MCD-1006D-VG</b>		
<b>Fry-Top</b> 	Multifunzione	<b>MCD-100FD-E3</b>		
	A gas ventilato	<b>MCD-100FD-VG</b>		
<b>Coup De Feu</b> 	Multifunzione	<b>MCD-100SD-E3</b>		
	A gas ventilato	<b>MCD-100SD-VG</b>		
<b>Friggitrice</b> 	Multifunzione	<b>MCD-100RD-E3</b>		
	A gas ventilato	<b>n.d.</b>		
<b>Barbecue</b> 	Multifunzione	<b>MCD-100BD-E3</b>		
	A gas ventilato	<b>MCD-100BD-VG</b>		
<b>1 Zona vetroceramica</b> 	Multifunzione	<b>MCD-100VD-E3</b>		
	A gas ventilato	<b>MCD-100VD-VG</b>		
<b>Vetroceramica</b> 	Multifunzione	<b>MCDE-100-E3</b>		
	A - ø 145 mm - 1200W B - ø 210/120 mm - 2200W/750W C - ø 180 mm - 1800W D - ø 265/170 mm - 2400W/1500W			
<b>Vetroceramica</b> 	Multifunzione	<b>MCDI-100-E3</b>		
	A - ø 145 mm - 1400W B - ø 180 mm - 1850W C - ø 210 mm - 2300W			

GAMMA COLORI		
		
Inox	Grafite-Mat	Bianco Antico
		
Rossoborgogna	Blu	Verdesmeraldo
		
Bianco		

**PIANO DI LAVORO INOX**

FINITURE	
	
<b>OTTONE (di serie)</b>	
	
<b>CROMO (a richiesta senza sovrapprezzo)</b>	
	
<b>BRUNITE (a richiesta con sovrapprezzo)</b>	

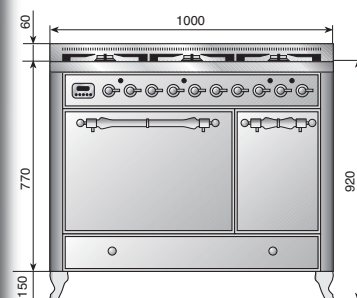

**PROFONDITÀ 70**





## CARATTERISTICHE TECNICHE:

Forno di sinistra: maxiforno 90 in versione multifunzione o gas ventilato. Forno di destra: mini 30 elettrico statico.

Maxiforno multifunzione 90: • classe energetica **A**; • termostato; • programmatore elettronico; • girarrosto; • grill elettrico.

MiniForno elettrico 30: • classe energetica **A**; • grill elettrico; • girarrosto.

Maxiforno a gas ventilato 90: • termostato con termocoppia; • grill elettrico; • programmatore elettronico.

Tutti i modelli sono dotati di porta fredda a triplo vetro.

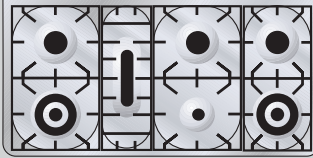
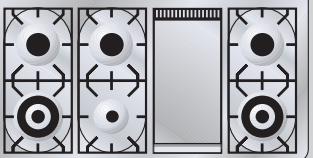
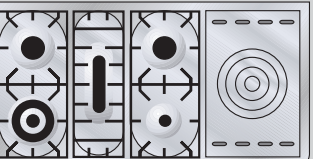
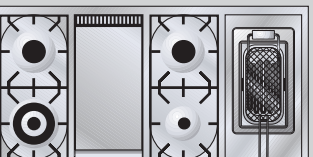
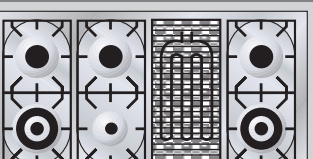
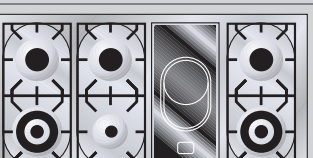
Tipologia piano cottura	Tipologiaforno	Codice modello	Finiture Ottone/Cromo€	Fin.Brunite€
<b>7 fuochi</b> 	Multifunzione	<b>MC-I207D-E3</b>		
	A gas ventilato	<b>MC-I207D-VG</b>		
<b>Fry-Top</b> 	Multifunzione	<b>MC-I20FD-E3</b>		
	A gas ventilato	<b>MC-I20FD-VG</b>		
<b>Coup De Feu</b> 	Multifunzione	<b>MC-I20SD-E3</b>		
	A gas ventilato	<b>MC-I20SD-VG</b>		
<b>Friggitrice</b> 	Multifunzione	<b>MC-I20FRD-E3</b>		
	A gas ventilato	<b>n.d.</b>		
<b>Barbecue</b> 	Multifunzione	<b>MC-I20BD-E3</b>		
	A gas ventilato	<b>MC-I20BD-VG</b>		
<b>1 Zona vetroceramica</b> 	Multifunzione	<b>MC-I20VD-E3</b>		
	A gas ventilato	<b>MC-I20VD-VG</b>		

### GAMMA COLORI

		
Inox	Grafite-Mat	Bianco Antico
		
Rossoborgogna	Blu	Verdesmeraldo
		
Bianco		

**PIANO DI LAVORO INOX**

### FINITURE

  
**OTTONE** (di serie)

  
**CROMO**  
(a richiesta senza sovrapprezzo)

  
**BRUNITE**   
(a richiesta con sovrapprezzo)



Maxiforno 90 cm

Mini 30 cm

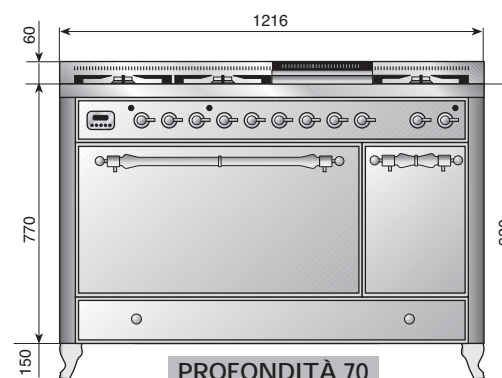





## CARATTERISTICHE TECNICHE:

Forno di sinistra: maxiforno 70 in versione multifunzione. Forno di destra: midi 40 elettrico statico.

Maxiforno multifunzione 70: • classe energetica **A**; • termostato; • programmatore elettronico; • girarrosto; • grill elettrico.

Maxiforno a gas ventilato 70: • termostato con termocoppia; • grill elettrico; • girarrosto; • programmatore elettronico.

MidiForno elettrico 40: • classe energetica **A**; • grill elettrico; • girarrosto.

Tutti i modelli sono dotati di porta fredda a triplo vetro.

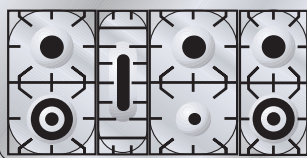
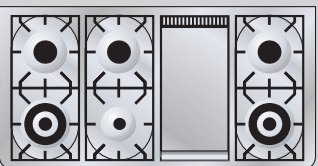
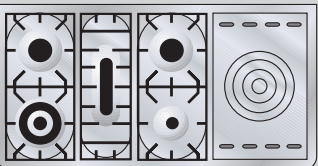
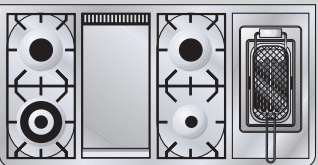
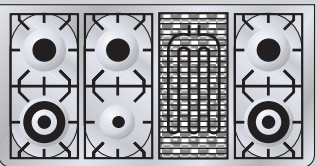
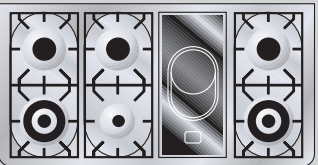
Tipologia piano cottura	Tipologiaforno	Codice modello	Fin.iture Ottone/Cromo€	Fin. Brunite€
<b>7 fuochi</b> 	Multifunzione	<b>MCS-I207D-E3</b>		
	A gas ventilato	<b>MCS-I207D-VG</b>		
<b>Fry-Top</b> 	Multifunzione	<b>MCS-I20FD-E3</b>		
	A gas ventilato	<b>MCS-I20FD-VG</b>		
<b>Coup De Feu</b> 	Multifunzione	<b>MCS-I20SD-E3</b>		
	A gas ventilato	<b>MCS-I20SD-VG</b>		
<b>Friggitrice</b> 	Multifunzione	<b>MCS-I20FRD-E3</b>		
	A gas ventilato	<b>n.d.</b>		
<b>Barbecue</b> 	Multifunzione	<b>MCS-I20BD-E3</b>		
	A gas ventilato	<b>MCS-I20BD-VG</b>		
<b>1 Zona vetroceramica</b> 	Multifunzione	<b>MCS-I20VD-E3</b>		
	A gas ventilato	<b>MCS-I20VD-VG</b>		

GAMMA COLORI		
		
Inox	Grafite-Mat	Bianco Antico
		
Rossoborgogna	Blu	Verdesmeraldo
		
Bianco		

PIANO DI LAVORO INOX

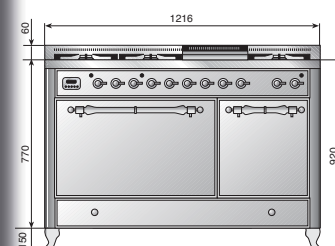

MCS-120

PROFONDITÀ 70



Forno 70 cm

Midi 40 cm



## CARATTERISTICHE TECNICHE:

Forno di sinistra: maxiforno 90 in versione multifunzione o gas ventilato. Forno di destra: standard 60 multifunzione.

Forno multifunzione 60: • classe energetica **A**; • termostato; • programmatore elettronico; • grill elettrico.

Maxiforno a gas ventilato 90: • termostato con termocoppia; • grill elettrico; • girarrosto.

Maxiforno multifunzione 90: • classe energetica **A**; • termostato; • grill elettrico; • girarrosto.

Tutti i modelli sono dotati di porta fredda a triplo vetro.

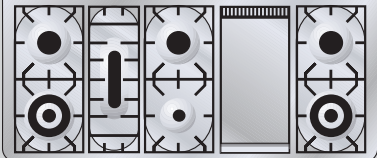
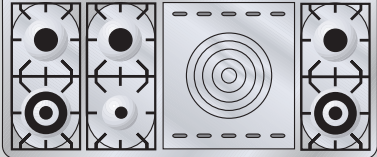
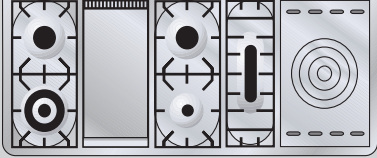
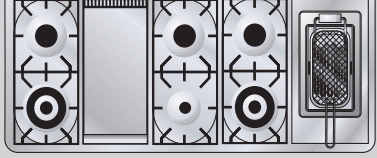
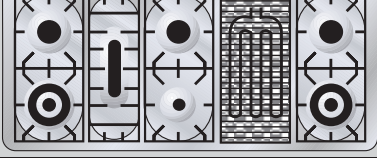
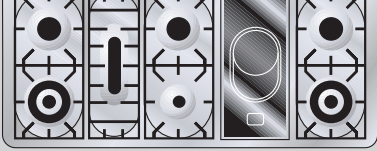
Tipologia piano cottura	Tipologia forno	Codice modello	Fin.iture Ottone/Cromo€	Finiture Brunite €
<b>Fry-Top</b> 	Multifunzione	<b>MC-I 50FD-E3</b> <b>MCA-I 50FD-E3</b>		
	A gas ventilato	<b>MC-I 50FD-VG</b> <b>MCA-I 50FD-VG</b>		
<b>Coup De Feu</b> 	Multifunzione	<b>MC-I 50SD-E3</b> <b>MCA-I 50SD-E3</b>		
	A gas ventilato	<b>MC-I 50SD-VG</b> <b>MCA-I 50SD-VG</b>		
<b>Fry-Top + Coup De Feu</b> 	Multifunzione	<b>MC-I 50FSD-E3</b> <b>MCA-I 50FSD-E3</b>		
	A gas ventilato	<b>MC-I 50FSD-VG</b> <b>MCA-I 50FSD-VG</b>		
<b>Friggitrice + Fry-Top</b> 	Multifunzione	<b>MC-I 50FRD-E3</b> <b>MCA-I 50FRD-E3</b>		
	A gas ventilato	<b>n.d.</b>		
<b>Barbecue</b> 	Multifunzione	<b>MC-I 50BD-E3</b> <b>MCA-I 50BD-E3</b>		
	A gas ventilato	<b>MC-I 50BD-VG</b> <b>MCA-I 50BD-VG</b>		
<b>1 Zona vetroceramica</b> 	Multifunzione	<b>MC-I 50VD-E3</b> <b>MCA-I 50VD-E3</b>		
	A gas ventilato	<b>MC-I 50VD-VG</b> <b>MCA-I 50VD-VG</b>		

### GAMMA COLORI

Inox	Grafite-Mat	Bianco Antico
Rossoborgogna	Blu	Verdesmeraldo
Bianco		

**PIANO DI LAVORO INOX**

### FINITURE



**OTTONE** (di serie)



**CROMO**  
(a richiesta senza sovrapprezzo)



**BRUNITE**  
(a richiesta con sovrapprezzo)

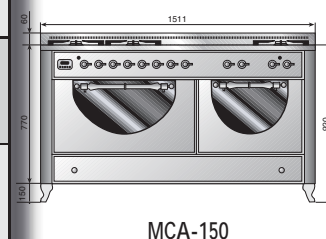
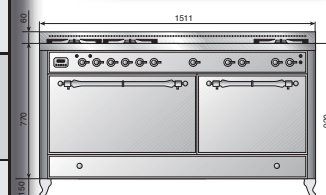

PROFONDITÀ 70



Maxiforno 90 cm Standard 60 cm

MCA-150FS-E3/RBX







Mod. / mm	A	B
M-70 / MT-70 / MC-70 / MCA-70	520	200
M-76 / MT-76 / MC-76 / MCA-76	520	200
M-90 / MT-90 / MC-90 / MCA-90	750	200
MD-100 / MTD-100 / MC-100	460	230
M-120 / MT-120 / MC-120	700	290
MS-120 / MTS-120 / MCS-120 / MCSA-120	675	230
M-150 / MT-150 / MC-150 / MCA-150	730	220

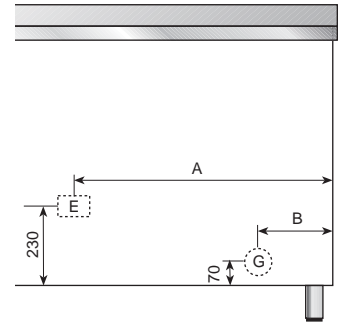

Vista posteriore

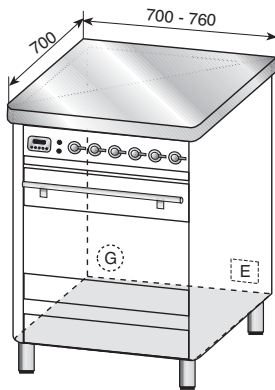

M70 - MT70 - MC70 - MCA70  
M76 - MT76 - MC76 - MCA76

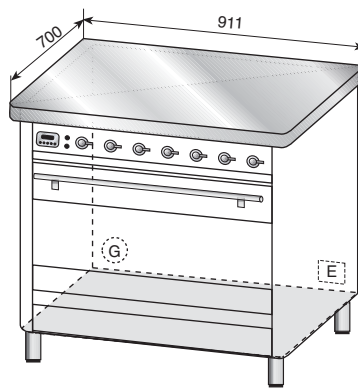

M90 - MT90 - MC90 - MCA90

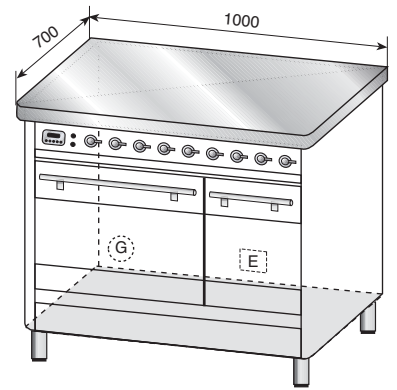

MD100 - MTD100 - MCD100

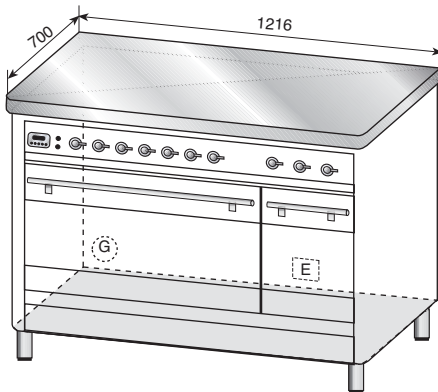

M120 - MT120 - MC120  
MS120 - MTS120 - MCS120 - MCSA120

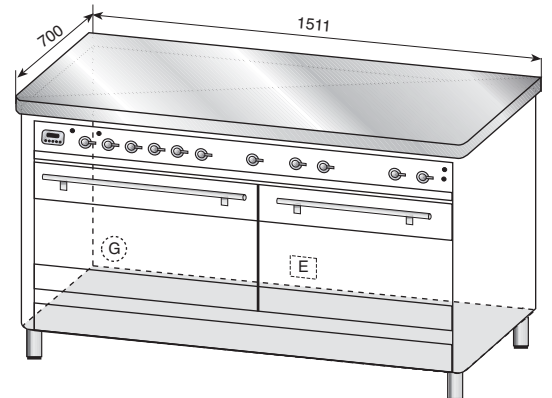

M150 - MT150 - MC150 - MCA150

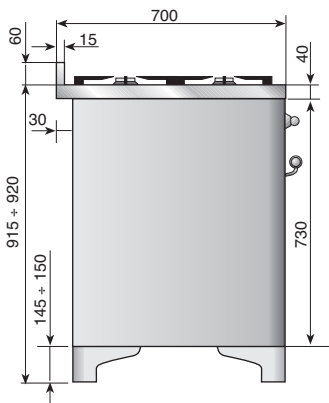

Majestic

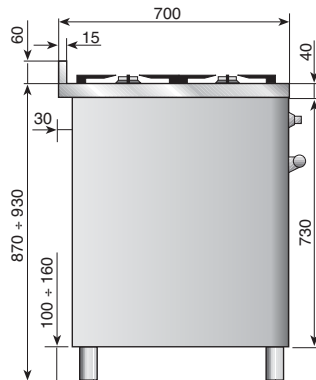

Majestic Techno

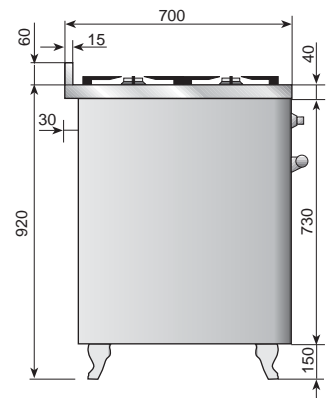

Majestic Country