

Jacob Delafon

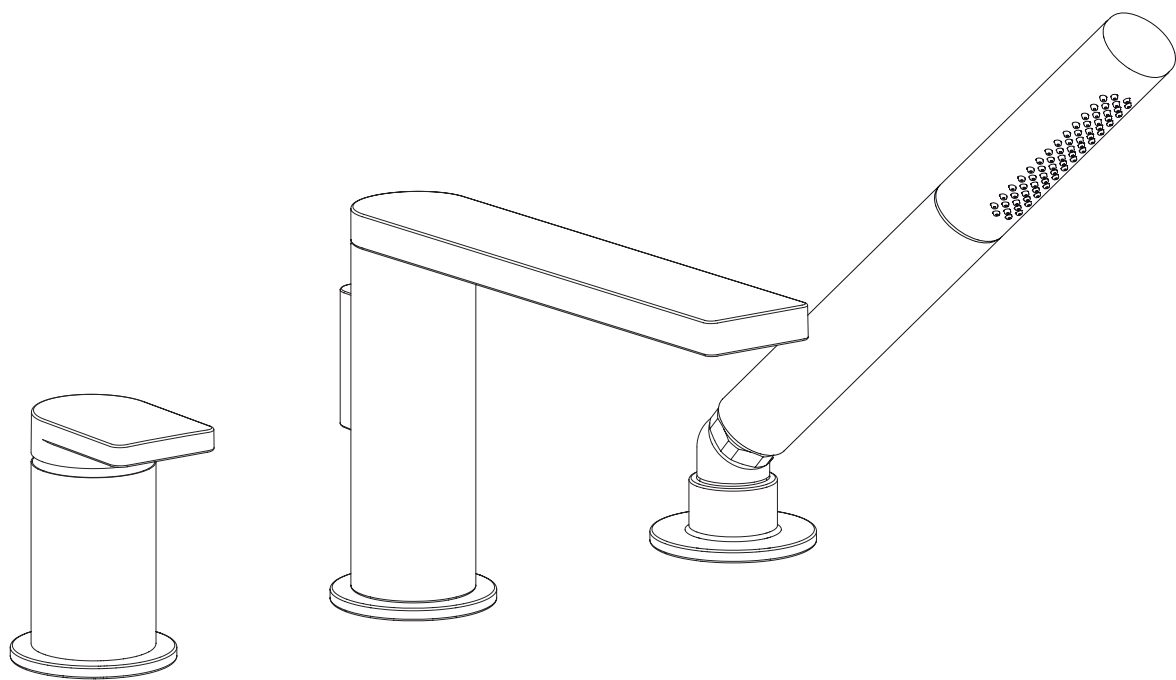

COMPOSED

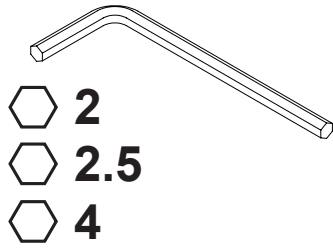
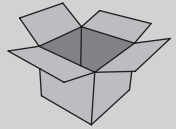
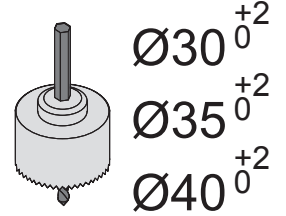
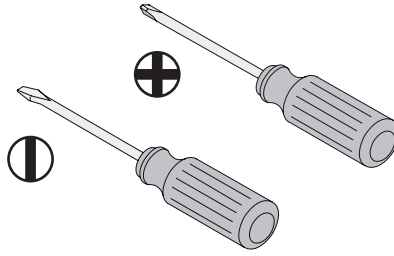
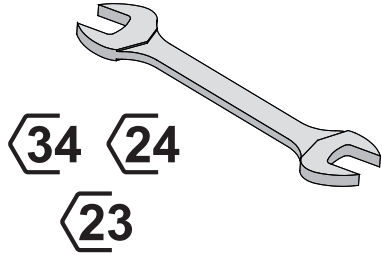
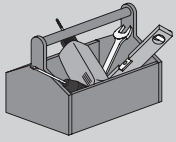

Bar

0.5 < 3 < 6

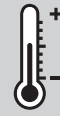

°C

55 < 60 < 65

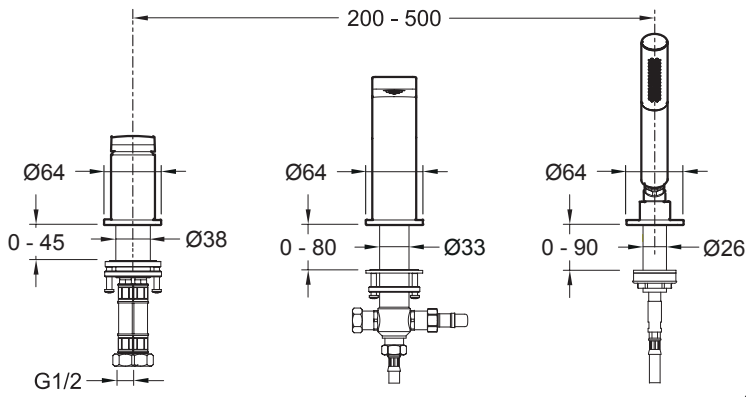

E73078-**

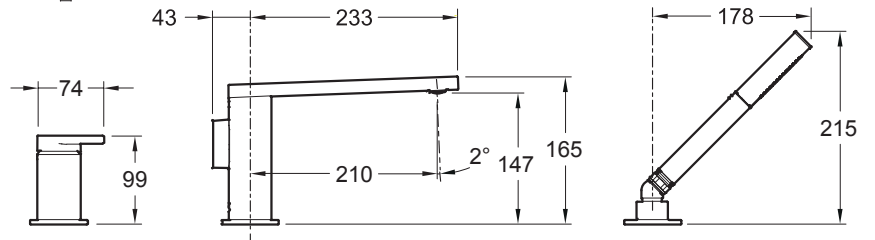

1

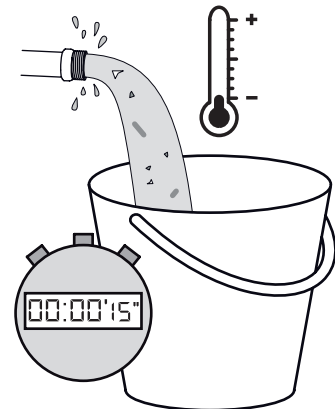
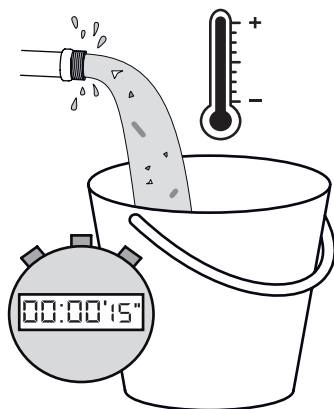

2

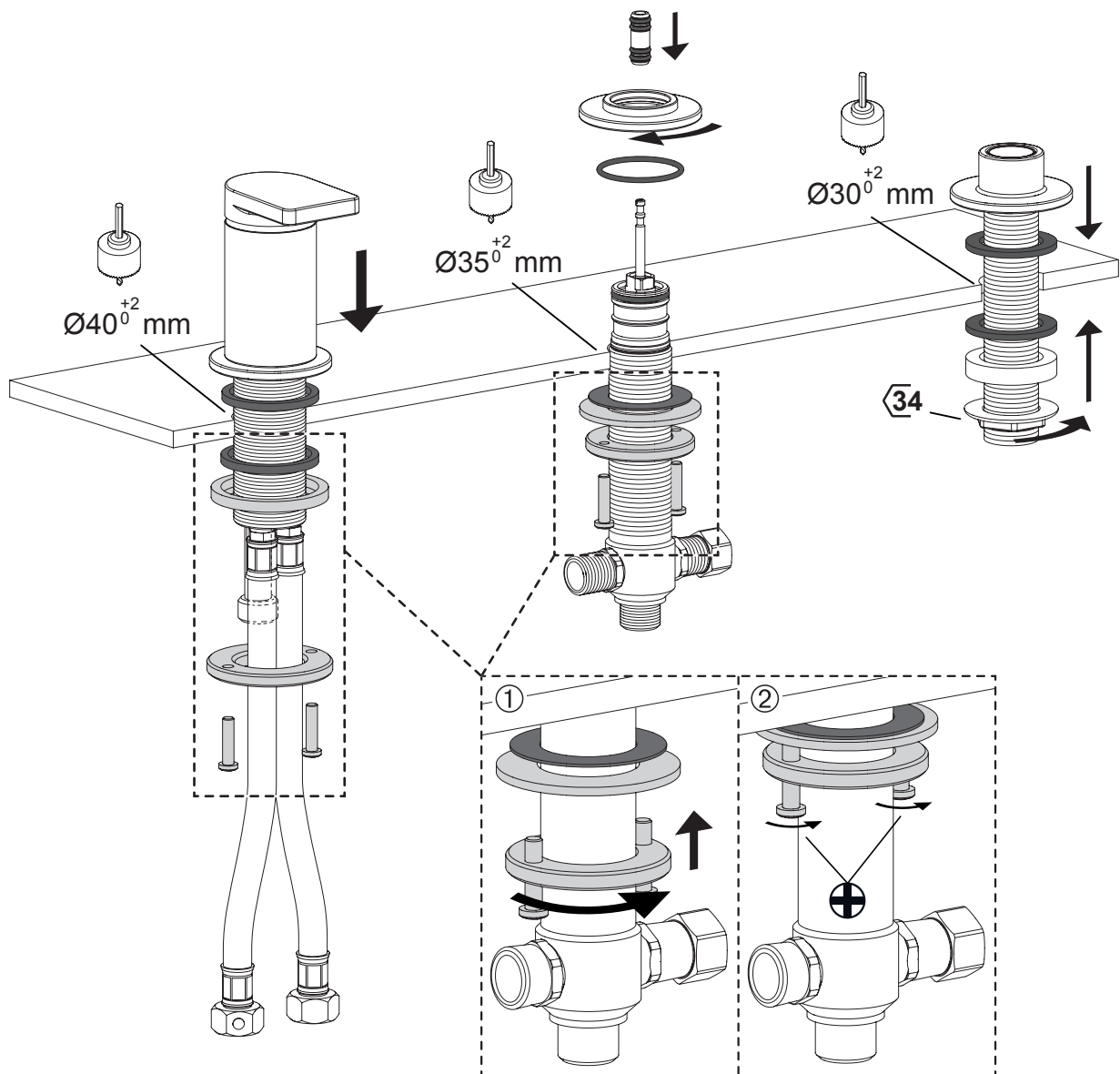
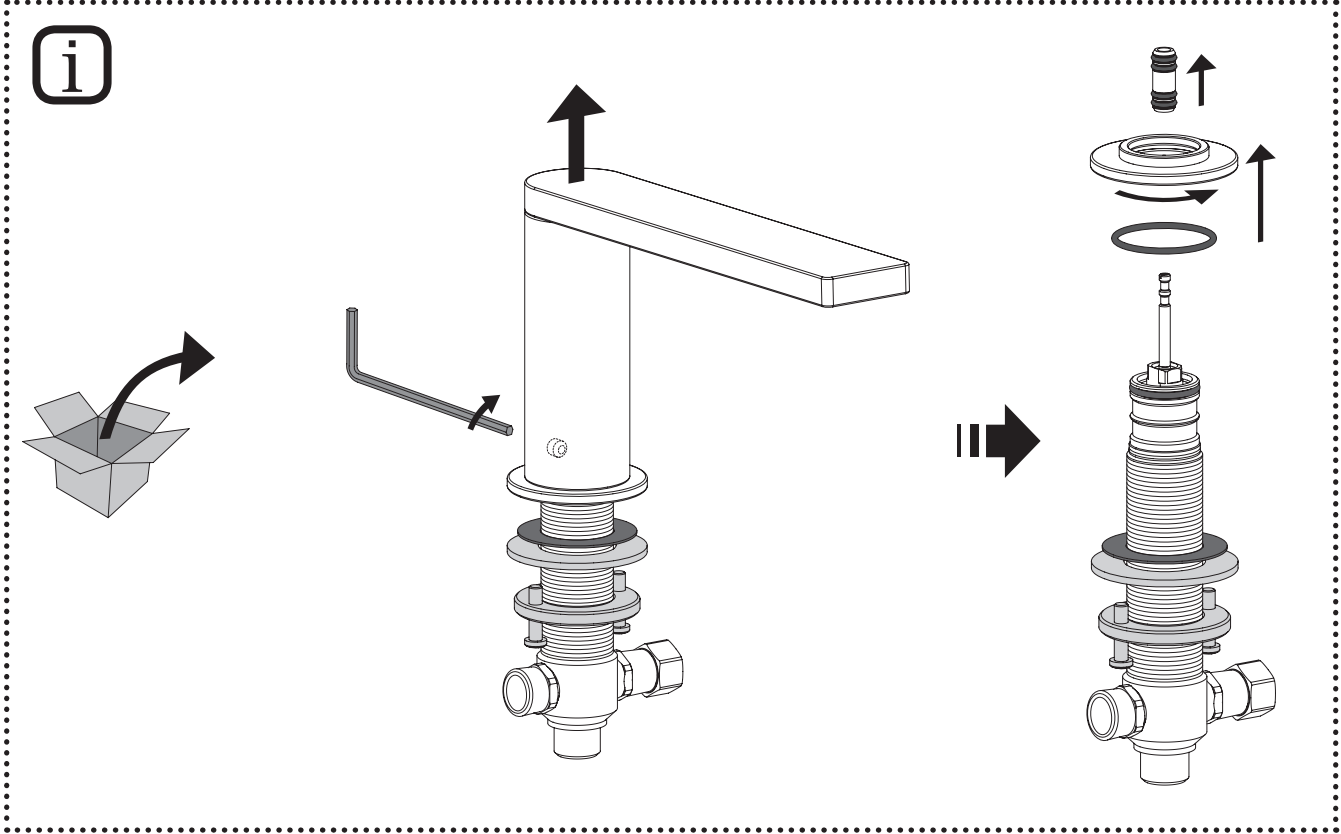

3

1

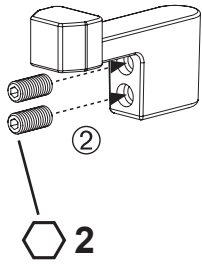

2

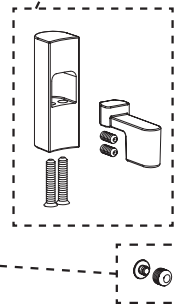
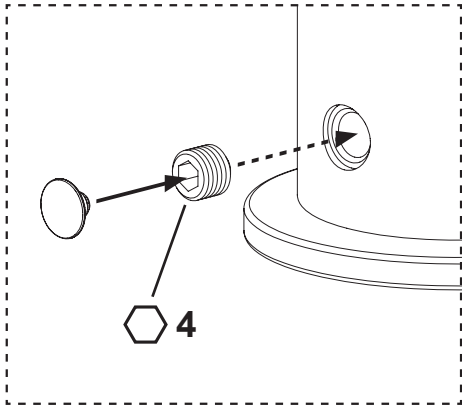
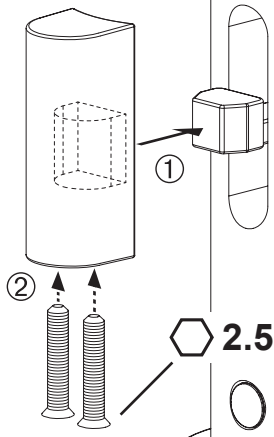

24

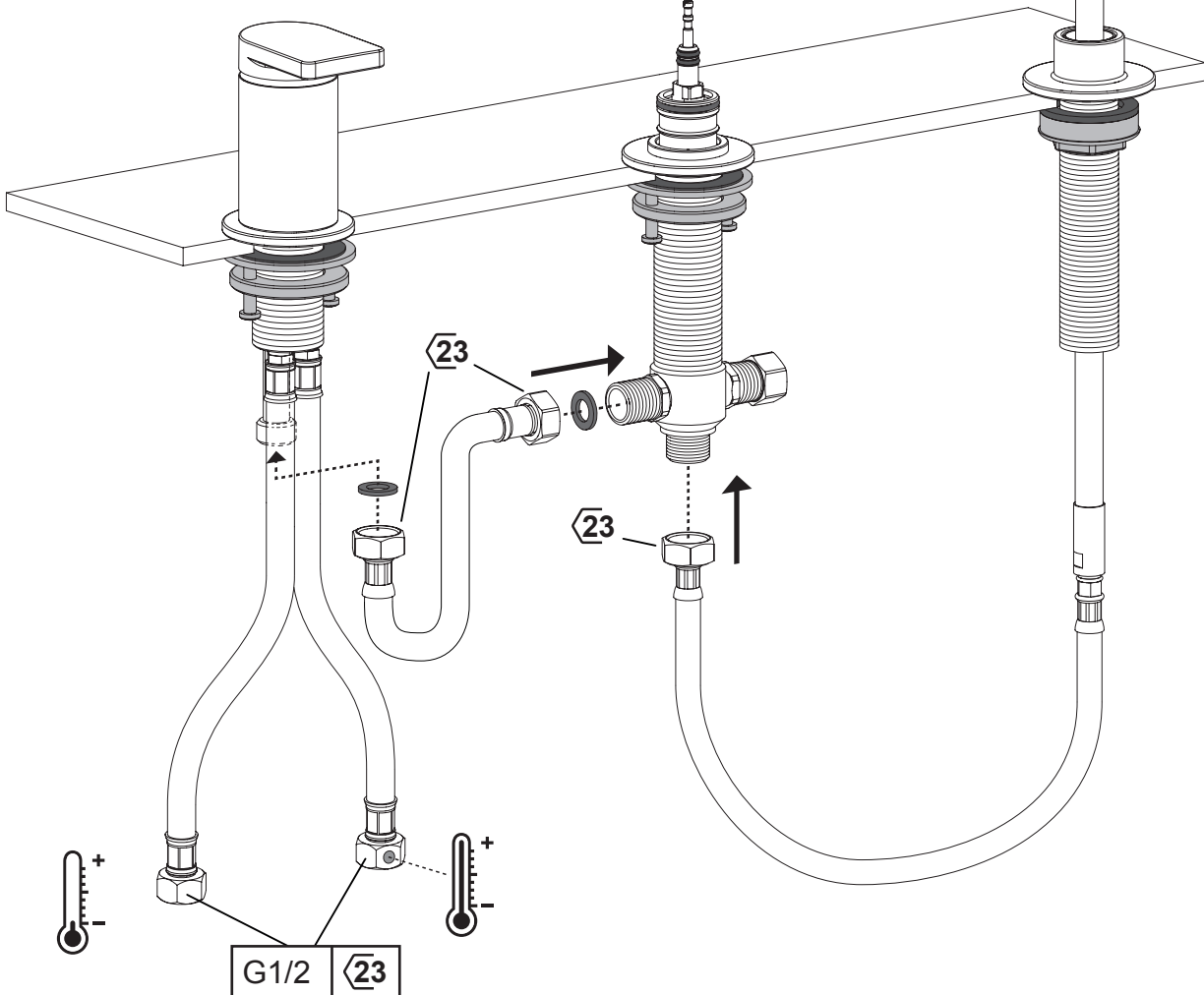
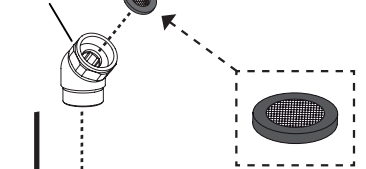

G1/2 23

4

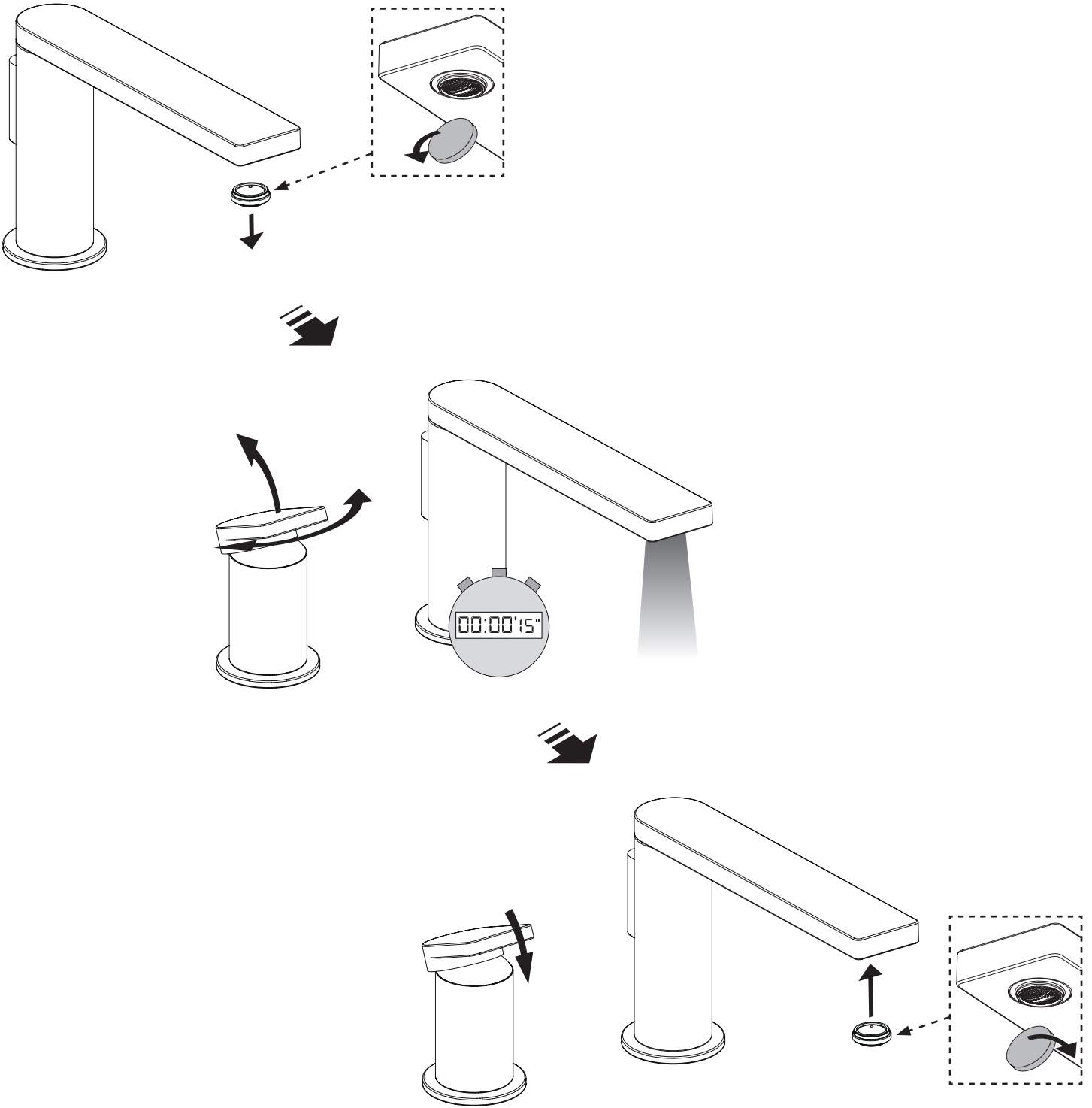

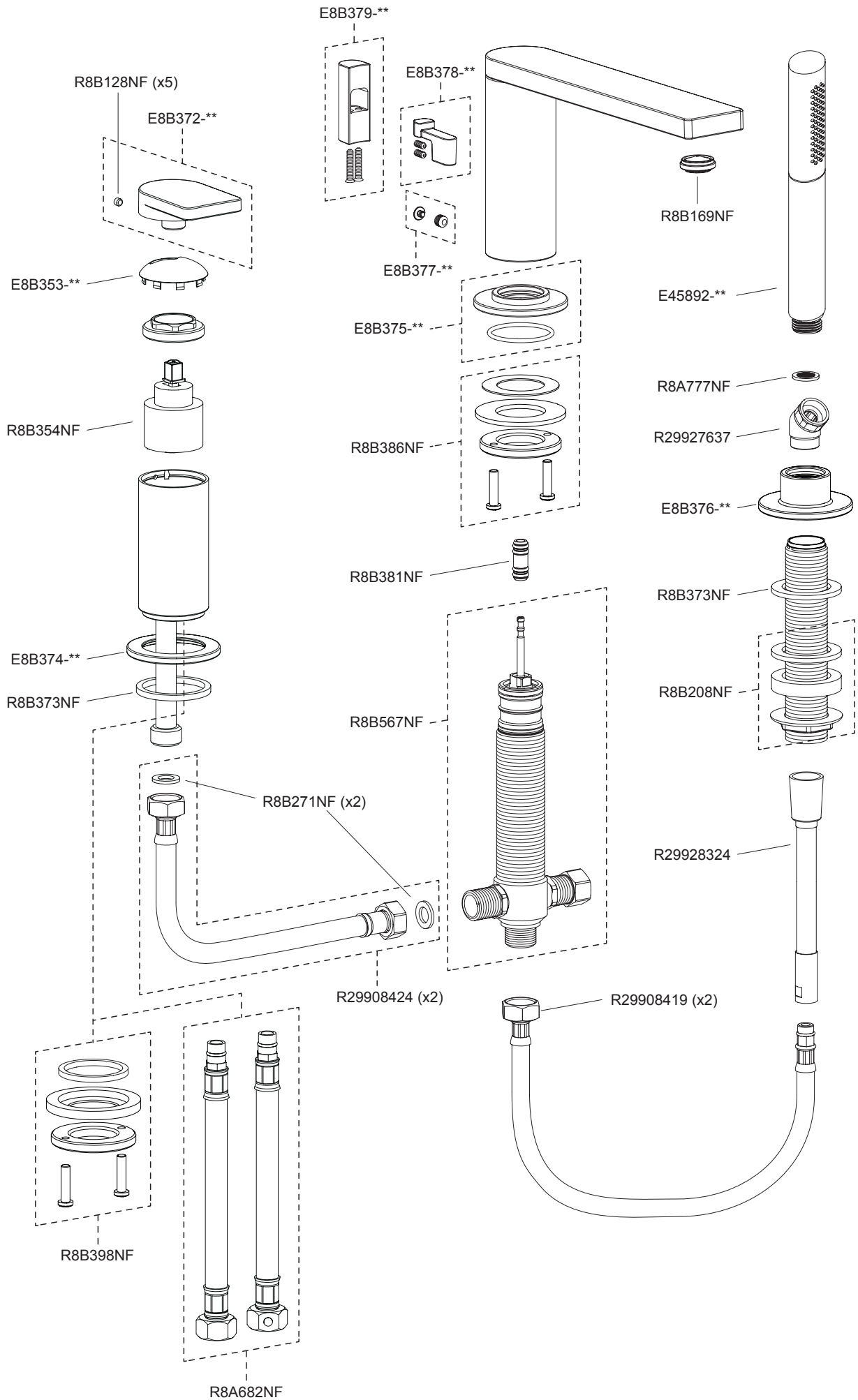

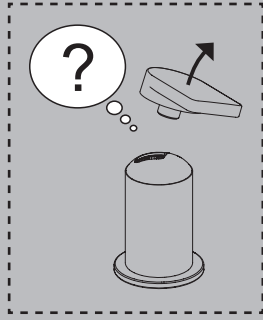
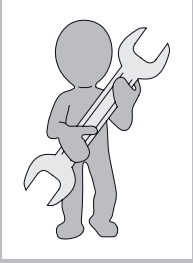

①

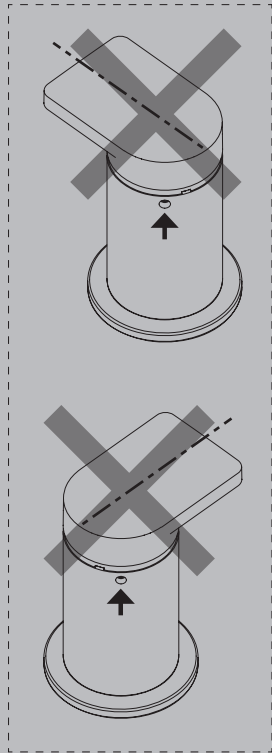
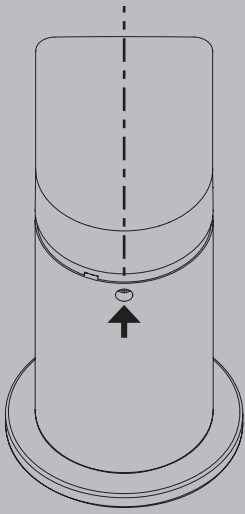

②

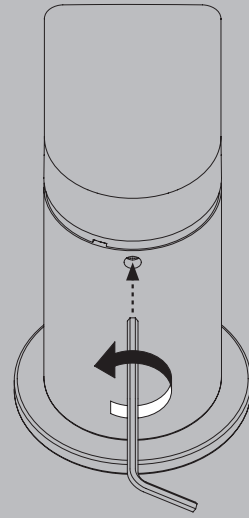

③

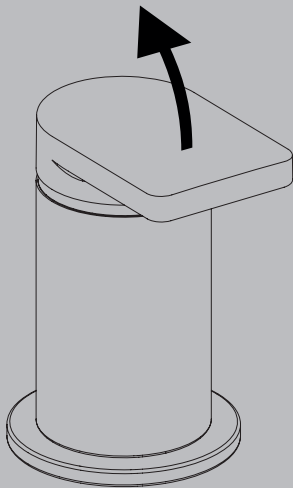

④

