

PRO



LAUFEN PRO

LAUFEN



For quite some time good design has no longer been the sole privilege of those who have powerful financial means. It is thanks to current industrial production methods and designers like Peter Wirz of «Vetica», who subscribe to optimal feasibility for their creations, that ceramic lines like LAUFEN pro are developing. This development is welcomed by designers as well as by customers.

Gutes Design ist heute längst nicht mehr nur einer zahlungskräftigen Käuferschicht vorbehalten. Dank industrieller Produktionsweise und Designern wie Peter Wirz von «Vetica», die bei ihren Kreationen auch stets die optimale Machbarkeit vor Augen haben, können Keramikserien wie LAUFEN pro entstehen. Das findet nicht nur der Designer gut, sondern vor allem auch der Kunde.

Aujourd'hui, le beau design n'est plus réservé à une caste de clients aux moyens financiers illimités. Grâce à la production industrielle et à des designers tels que Peter Wirz de «Vetica» qui, dans leur créativité, ont toujours donné à l'esprit une faisabilité optimale, des séries céramique comme celle proposée avec LAUFEN pro sont désormais chose possible. Le designer y trouve certes son compte, mais aussi et surtout le client.

Oggi il bel design non è più riservato solo ad una fascia alta di mercato. Grazie ai metodi di produzione industriale ed a designer come Peter Wirz della «Vetica», che tengono sempre in considerazione la fattibilità di ogni creazione, è nata la serie di sanitari LAUFEN pro. Perfetta non solo per i designer ma anche e soprattutto per i clienti.

SANITARY WARE

Sanitärkeramik
Céramique sanitaire
Ceramica sanitaria

Overview/Übersicht/aperçu/sommario	06
LAUFEN pro S	08
LAUFEN pro B	18
LAUFEN pro A	22
LAUFEN pro WCs	26
LAUFEN pro rimless WCs	32

SPECIAL APPLICATIONS

Besondere Anwendungen
Applications spécifiques
Applicazioni speciali

Hotel solutions	34
Public spaces	36
Barrier free (LAUFEN pro liberty)	40

BATHROOM FURNITURE

Badezimmermöbel
Mobilier de salle de bains
Mobili da bagno

LAUFEN pro furniture/Möbel/ meubles/mobili	44
---	----

BATHTUBS

Badewannen
Baignoires
Vasche da bagno

LAUFEN pro bathtubs/Badewannen/ baignoires/vasche da bagno	48
---	----

FEATURES AND BENEFITS

Eigenschaften und Vorteile
Caractéristiques et avantages
Caratteristiche e vantaggi

Sanitary ware/Sanitärkeramik/ céramique sanitaire/ceramica sanitaria	51
Furniture/Badezimmermöbel/ mobilier de salle de bains/mobili da bagno	56
Bathtubs/Badewannen/ baignoires/vasche da bagno	57

TECHNICAL INFORMATION

Technische Informationen
Informations techniques
Informazioni tecniche

58

It is possible that not all products, sizes or colours are available in every country. The price list of your LAUFEN subsidiary is the most accurate reference point for product availability. Delivery periods may also differ.

Unter Umständen sind nicht alle Produkte, Größen oder Farben in jedem Land verfügbar. Bitte nutzen Sie die Preisliste der jeweiligen LAUFEN Niederlassung als Referenz für das verfügbare Produktsortiment. Auch die jeweiligen Lieferzeiten können von Land zu Land abweichen.

Il se peut que les produits ne soient pas tous disponibles dans chaque pays dans toutes les dimensions et coloris. La liste de prix de votre filiale LAUFEN est la référence la plus sûre en ce qui concerne la disponibilité des produits. Les délais de livraisons peuvent également varier d'un pays à l'autre.

È possibile che non tutti i prodotti, le misure e i colori siano ugualmente disponibili in ogni Paese. Si prega di utilizzare il listino prezzi della vostra filiale LAUFEN come riferimento per la gamma di prodotti disponibili. Anche i tempi di consegna possono variare da un paese all'altro.

WHY OUR CLIENTS RELY ON LAUFEN PRO



WHY THE BUILDING CONTRACTOR RELIES ON LAUFEN PRO

As one of the world leaders in the manufacturing of sanitary ceramics, LAUFEN is intimately familiar with the building trade and their customers. We also realise that the bathroom has become an increasingly important criterion for the success of private and public projects. LAUFEN responds to this Renaissance of bathroom culture with a multiplicity of bathroom programmes extending into the luxury class. With its continually enhanced, successful LAUFEN pro range, LAUFEN demonstrates that good design and good quality do not necessarily mean high installation costs, because contemporary industrial design implemented intelligently can be attractive both to the eye and the budget.

WESHALB DER UNTERNEHMER MIT LAUFEN PRO RECHNET

Als einer der weltweit führenden Hersteller von Sanitärkeramik kennt LAUFEN die Besonderheiten des Baugewerbes und seiner Kunden. Und weiss deshalb auch, dass das Badezimmer sich immer mehr zu einem wichtigen Kriterium für den Erfolg von privaten und öffentlichen Projekten entwickelt hat. LAUFEN begegnet dieser Renaissance der Badekultur mit einer Vielzahl von Badezimmerprogrammen, die bis in die Luxusklasse reichen. Mit dem bewährten und stetig weiterentwickelten LAUFEN pro tritt LAUFEN den Beweis an, dass gutes Design und gute Qualität nicht mit hohen Anschaffungskosten gleichgesetzt werden müssen. Denn zeitgemässes Industriedesign kann, wenn intelligent produziert, sowohl für das Auge als auch für das Budget attraktiv sein.

VOICI POURQUOI L'ENTREPRENEUR SE FIE À LAUFEN PRO

Faisant partie des leaders mondiaux de la céramique sanitaire, LAUFEN connaît les particularités du secteur de la construction et de ses clients. Et sait aussi que la salle de bain est un critère de plus en plus décisif pour la réussite de projets privés et publics. LAUFEN va au-devant de cette renaissance de l'art du bain avec un grand nombre de programmes de salles de bains qui culminent dans les agencements de luxe. Avec la solution éprouvée et en constante évolution LAUFEN pro, la preuve est donnée, si besoin était, que le bon design et l'excellente qualité ne sont pas forcément synonymes de coûts d'acquisition élevés. Car le design industriel actuel, s'il est intelligemment produit, peut être à la fois attrayant pour l'œil et pour le budget.

ECCO PERCHÉ L'IMPRESA EDILE CONTA SU LAUFEN PRO

Essendo uno tra i principali produttori di sanitari in ceramica al mondo, LAUFEN conosce perfettamente le esigenze delle imprese edili e dei loro clienti. Sa quindi anche che il bagno ha acquistato un valore sempre più importante per il successo di progetti pubblici e privati. LAUFEN risponde a questa rinascita della cultura del bagno con una ampia molteplicità di serie, anche di lusso. Con la serie LAUFEN pro, LAUFEN dimostra che bel design e buona qualità non significano necessariamente prezzi alti. Il design industriale moderno, se abbinato ad una produzione intelligente, può essere attraente sia a livello estetico che di prezzo.



WHY THE ARCHITECT AND THE INTERIOR DESIGNER PLANS WITH LAUFEN PRO

The bathroom used to be regarded merely as a functional room to which little importance was attached. With the growing emphasis on wellness, the desire for relaxation and care became progressively stronger. Today architects accept these wishes for more bath culture and require bathroom programmes that can meet various expectations. They prefer flexible systems that allow the optimal use of space. Design concepts that can be integrated continuously.

WESHALB DER ARCHITEKT UND DER INTERIOR DESIGNER MIT LAUFEN PRO PLANT

Früher war das Badezimmer lediglich ein reiner Funktionsraum und wurde deshalb gestalterisch vernachlässigt. Heute ist das Bad ein Wellnessraum; hier entspannen und pflegen sich die Menschen. Architekten greifen den Wunsch nach mehr Badekultur auf und verlangen nach Badezimmerprogrammen, die diesen Ansprüchen gerecht werden. Sie schätzen flexible Systeme, die eine optimale Raumausnutzung ermöglichen und Designkonzepte, die sich durchgängig integrieren lassen.

VOICI POURQUOI L'ARCHITECTE ET LE DESIGNER PLANIFIENT AVEC LAUFEN PRO

Dans le passé, la salle de bain n'était qu'une simple cellule humide et donc sans grande importance. Mais avec la vague croissante de bien-être, le souhait de disposer d'un véritable lieu de détente et de soins n'a cessé de se propager. Aujourd'hui, les architectes exaucent ce désir et cette demande en programmes de salles de bains répondant aux attentes les plus exigeantes. Ils apprécient les systèmes souples, gages d'une exploitation optimale de l'espace. Des concepts de design qui s'intègrent sans faille.

ECCO PERCHÉ L'ARCHITETTO E IL DESIGNER UTILIZZANO LAUFEN PRO PER I LORO PROGETTI

Una volta, il bagno era solo una stanza in cui lavarsi e non aveva quindi molta importanza. Con l'evolversi del concetto di benessere, si è intensificato anche il desiderio di un luogo di relax e cura del corpo. Oggi gli architetti fanno proprie queste richieste e scelgono prodotti in grado di soddisfarle. Apprezzano i sistemi flessibili che permettono uno sfruttamento ottimale dello spazio. Idee di design perfettamente integrabili.



WHY SANITARY PLUMBERS ARE HAPPY TO USE LAUFEN PRO PRODUCTS

To prevent wasting the time or nerves of sanitary engineers, all LAUFEN pro products are extremely easy to install, comply with the specifications of the different countries and are always readily available. In this way building operations are expedited.

WESHALB DER SANITÄR-INSTALLATEUR LAUFEN PRO GERNE IN DIE HAND NIMMT

Damit der Sanitärinstallateur weder Zeit noch Nerven verliert, sind alle Produkte von LAUFEN pro äußerst montagefreundlich, erfüllen die länderspezifischen Vorgaben und sind immer schnell verfügbar. So kommt der Bau im Handumdrehen voran.

VOICI POURQUOI L'INSTALLATEUR SANITAIRE PREND VOLONTIERS EN MAIN LAUFEN PRO

Parce que l'installateur sanitaire n'a pas de temps à perdre, tous les produits de LAUFEN pro sont d'un montage extrêmement aisé, satisfont aux normes spécifiques de chaque pays et leur disponibilité est toujours très rapide. Ainsi, il n'y a aucun retard de construction à déplorer.

ECCO PERCHÉ L'INSTALLATORE AMA LAVORARE CON LAUFEN PRO

Per non far perdere né tempo né pazienza all'installatore, tutti gli articoli della serie LAUFEN pro sono estremamente facili da montare e rispettano le normative nazionali. Così i lavori finiscono prima.

LAUFEN PRO S

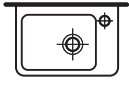

36 x 25 cm



48 x 28 cm

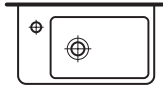

48 x 28 cm

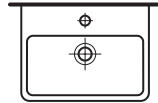

45 x 34 cm

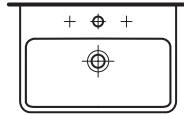

55 x 38 cm

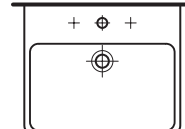

55 x 46.5 cm

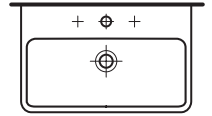

60 x 38 cm

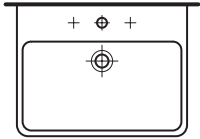

60 x 46.5 cm

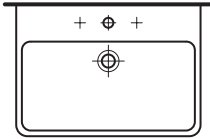

65 x 46.5 cm

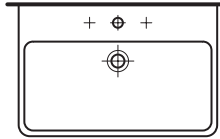

70 x 46.5 cm

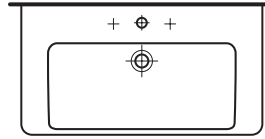

85 x 46 cm

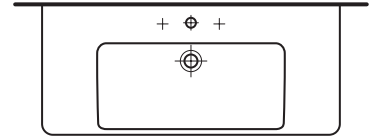

105 x 46 cm

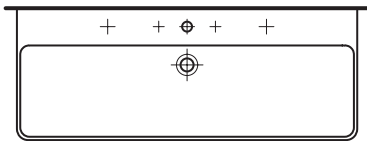

120 x 46 cm

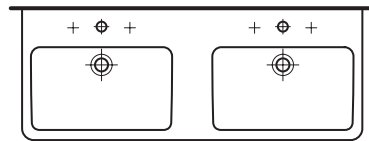

120 x 46 cm

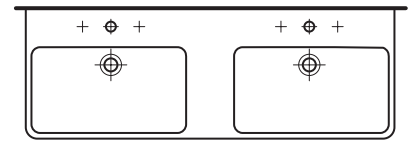

130 x 46 cm

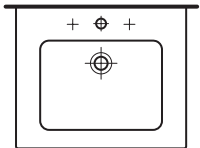

60 x 50 cm

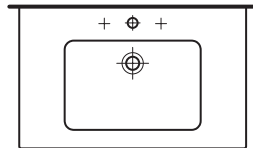

80 x 50 cm

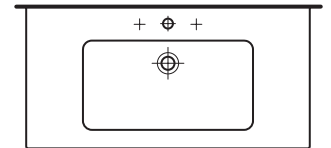

100 x 50 cm

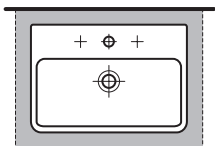

55 x 38 cm

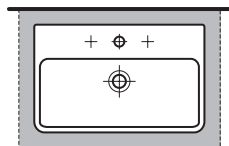

60 x 38 cm

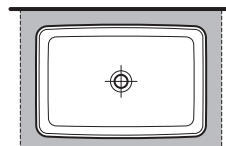

60 x 40 cm

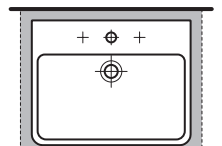

56 x 44 cm

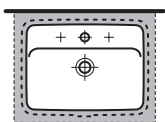

49 x 36 cm

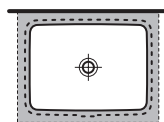

49 x 36 cm

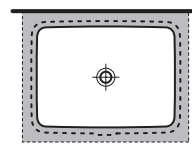

55 x 38 cm

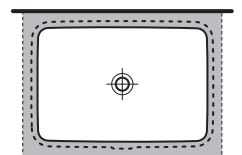

60 x 40 cm

LAUFEN PRO B

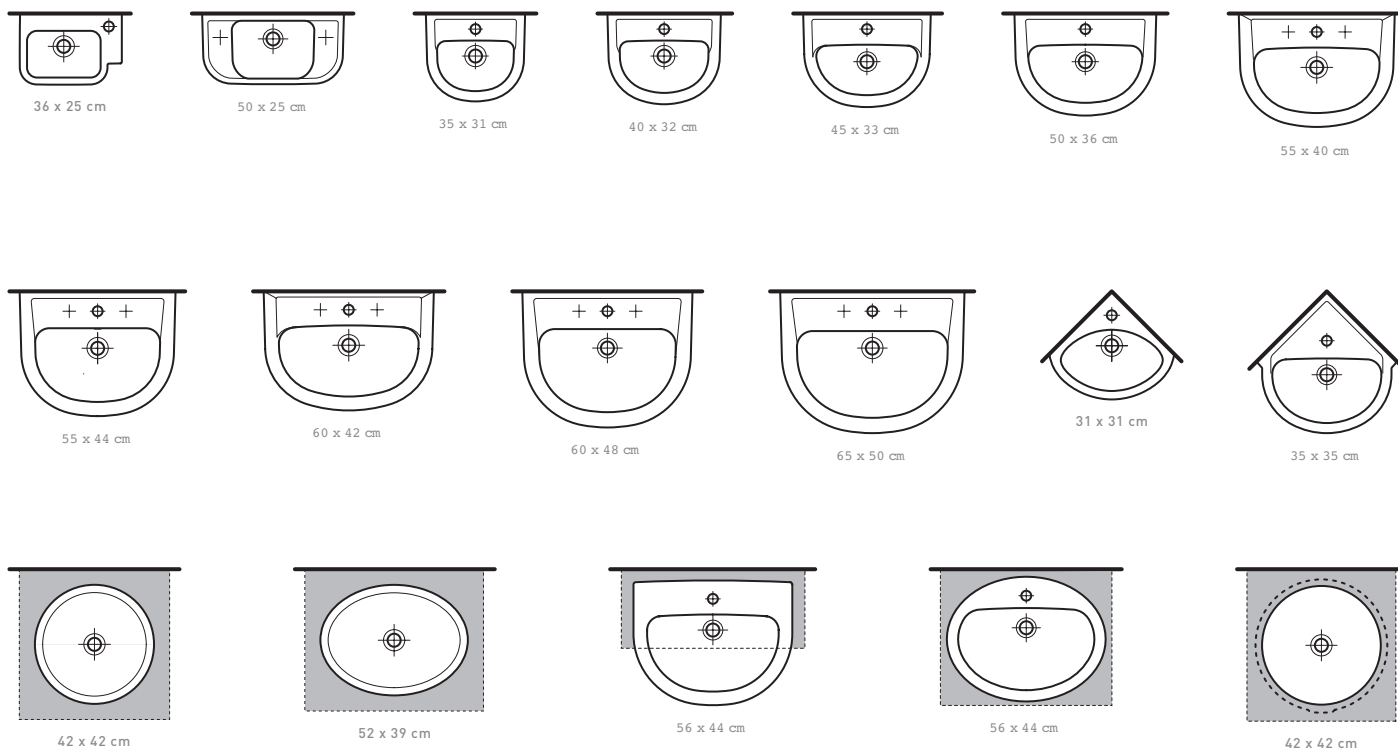

LAUFEN PRO A

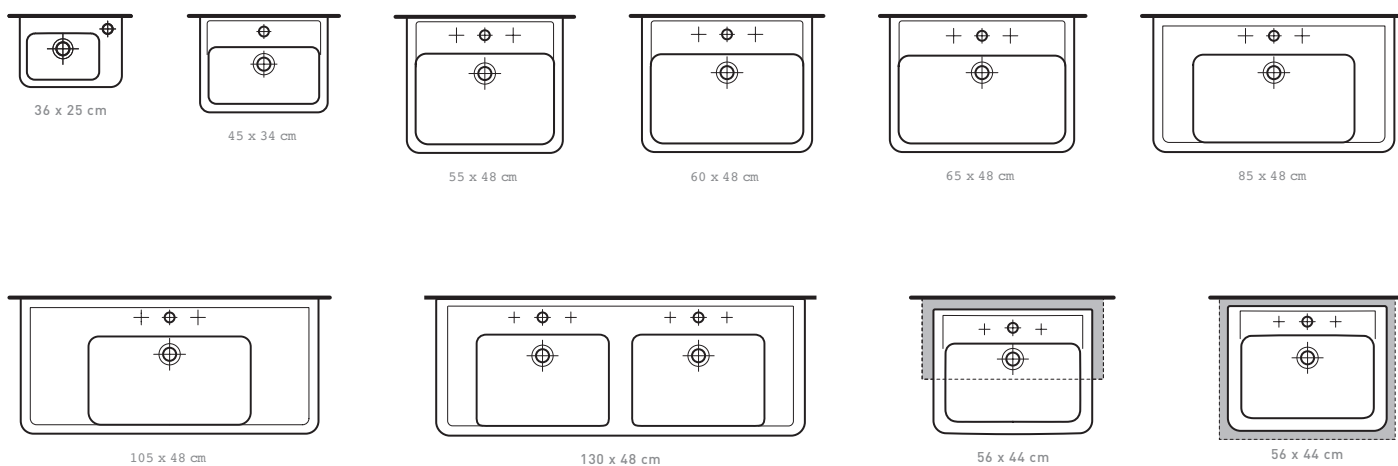

LAUFEN PRO LIBERTY

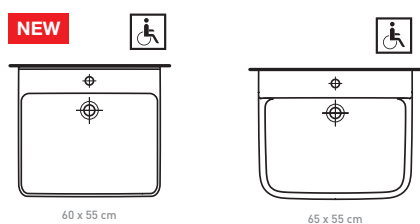

LAUFEN PRO S





reddot award 2014
winner

The Swiss designer Peter Wirz is also responsible for LAUFEN pro S. With heaps of sensitivity, he brought about a systematic, production-optimised evolution of the pro concept: Thanks to its slim silhouette and clearly-defined radii, the washbasin has a light and elegant appearance. The deep bowl means that it's also functionally appealing. The aesthetics of LAUFEN pro S therefore definitely take the range in the direction of LAUFEN's premium design lines – while remaining affordable by all.

Mit viel Fingerspitzengefühl verfolgte Designer Peter Wirz bei LAUFEN pro S eine konsequente, produktionsoptimierte Evolution des pro-Gedankens: Dank ihrer schlanken Silhouette und den klar definierten Radien wirken die Waschtische leicht und elegant, das tiefe Becken sorgt für viel Funktionalität. Damit rückt die Ästhetik von LAUFEN pro S zweifellos in Richtung der Premium-Designlinien von LAUFEN – und bleibt doch für jedermann erschwinglich.

LAUFEN pro S est une création du designer suisse Peter Wirz. Avec beaucoup de doigté, il était en quête d'une évolution, conséquente et optimisée pour la production, du projet pro: Grâce à sa silhouette élancée et aux rayons clairement définis, les lavabos ont une apparence légère et élégante, la vasque profonde garantit une grande fonctionnalité. L'esthétique de LAUFEN pro S peut, sans le moindre doute, rivaliser avec les autres lignes au design hors pair signé LAUFEN – tout en restant abordable pour tous.

LAUFEN pro S è stata progettata dal designer svizzero Peter Wirz, che ha perseguito e ottimizzato con grande sensibilità l'evoluzione coerente del concetto che sta alla base della serie pro. Grazie alla sua linea slanciata e ai bordi arrotondati molto definiti, i lavabi hanno un aspetto leggero ed elegante, mentre la profondità del bacino garantisce un'elevata funzionalità. L'estetica di LAUFEN pro S si avvicina indubbiamente a quella delle linee di design premium di LAUFEN, pur rimanendo alla portata di tutti.

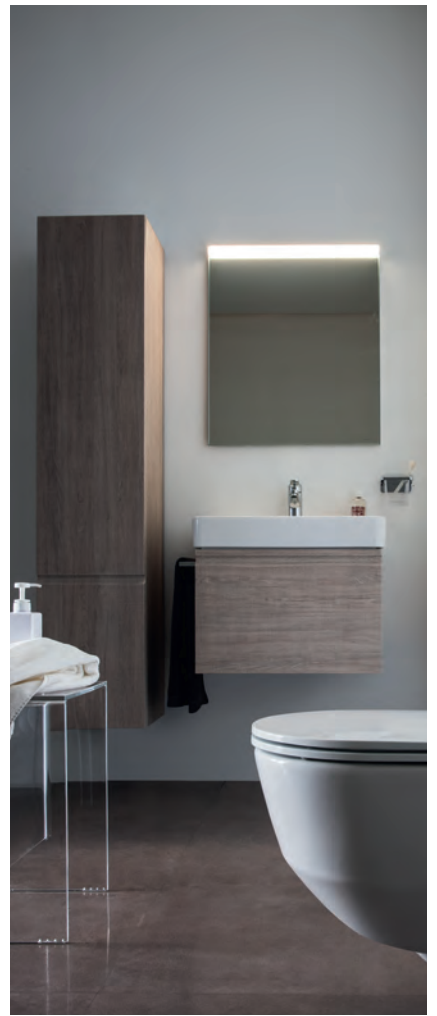



The new LAUFEN pro S WC is a geometric wall-hung WC which comes with a matching bidet. It fits in perfectly with the redesign of the LAUFEN pro S washbasins. Thanks to the concealed LAUFEN EasyFit wall mounting system (PCT pat. pend.), the ceramics have a flawless appearance and are easy to clean.

Das neue LAUFEN pro S WC ist ein geometrisches Wand-WC samt passendem Bidet, das perfekt mit dem Redesign der LAUFEN pro S Waschtische harmoniert. Dank des zum Patent angemeldeten versteckten Wand-Montagesystems LAUFEN EasyFit präsentiert sich die Keramik makellos und reinigungsfreundlich.

Le nouveau WC LAUFEN pro S est un WC mural géométrique, fourni avec un bidet assorti, qui se marie parfaitement avec les lavabos LAUFEN pro S remaniés. Grâce au système de montage mural invisible LAUFEN EasyFit (PCT pat. pend.), la céramique reste impeccable et se nettoie facilement.

Il nuovo vaso LAUFEN pro S è un vaso sospeso di linea geometrica e coordinato al bidet, che si armonizza perfettamente con il re-design dei lavabi LAUFEN pro S. Grazie al sistema di fissaggio murale nascosto LAUFEN EasyFit (PCT pat. pend.), i sanitari si presentano nella loro perfezione e sono più facili da pulire.



Please find information about **LAUFEN EasyFit system** on page 53.

Informationen zum **LAUFEN EasyFit system** finden Sie auf Seite 53.

Pour informations relatives à **LAUFEN EasyFit system** voir sur page 53.

Per informazioni su **LAUFEN EasyFit system** consultare pagina 53.



The LAUFEN pro S range contains practical furniture with high-quality details such as integrated handles and gently closing drawers with no siphon cut-out. Available in glossy white, matt white, wenge, bright oak, graphite and 39 special colours.

Zu LAUFEN pro S gehören praktische Möbel mit wertigen Details wie integrierte Griffleisten oder sanft schließende Schubladen ohne Siphonausschnitt. Erhältlich in Weiß glänzend, Weiß matt, Wenge, Eiche hell und Graphit sowie 39 weiteren Sonderfarben.

LAUFEN pro S se compose de meubles pratiques avec des détails valorisants comme les poignées intégrées ou les tiroirs à fermeture en douceur sans découpe pour le siphon. Existe en blanc brillant, blanc mat, wengé, chêne clair et graphite, ainsi que 39 autres coloris spéciaux.

La serie LAUFEN pro S é costituita da mobili pratici dai dettagli di pregio, come le maniglie a barra integrate o i cassetti che si chiudono delicatamente, senza taglio per il sifone. Sono disponibili nei colori Bianco brillante, Bianco opaco, Wengé, Rovere chiaro e Grafite, ed inoltre in altri 39 colori speciali.



If space is scarce, good ideas are required. Laufen pro S compact solutions give you the opportunity to devise a comprehensive design concept, even in the most restricted spaces. Our washbasins and WCs have a short projection which saves valuable space.

Wo wenig Raum vorhanden ist, sind gute Ideen gefragt. Mit den kompakten Problemlösern von LAUFEN pro kann ein durchgängiges Designkonzept selbst bei engsten Raumverhältnissen realisiert werden. Waschtische und WCs haben eine geringere Ausladung und sparen so wertvollen Platz ein.

Là où l'espace est rare, il faut avoir de bonnes idées. Les solutions compactes aux problèmes de LAUFEN pro permettent de réaliser un concept de design homogène, même dans les espaces les plus exigus. Les lavabos et WC présentent un faible allongement et permettent ainsi d'économiser de l'espace précieux.

Laddove lo spazio è poco, ci vogliono buone idee. Con le soluzioni compatte LAUFEN pro è possibile realizzare un progetto di design completo anche in spazi molto ridotti. I lavabi e i vasi presentano una profondità ridotta e consentono di risparmiare spazio prezioso.







Slim, light and bold – LAUFEN pro S is the new member of the successful LAUFEN pro series. Thanks to the delicate redesign, the elegant pro S is compatible with all pro variants.

Schlanker, leichter, klarer – LAUFEN pro S ist das neue Familienmitglied der erfolgreichen LAUFEN pro Serie. Ihr behutsames Redesign macht das elegante pro S kompatibel zu allen pro-Varianten.

Encore plus élancé, plus léger et plus clair – LAUFEN pro S est le nouveau membre de la famille de la série LAUFEN pro, couronnée de succès. Grâce au remaniement, avec précaution, de son design, l'élégant pro S est compatible avec toutes les variantes pro.

Più snello, più leggero, più pulito: LAUFEN pro S è il nuovo componente della fortunata serie LAUFEN pro. Il suo avveduto re-design rende l'elegante pro S compatibile con tutte le versioni della serie pro.







The elegant and subtle LAUFEN pro S furniture-mounted washbasins with deep, highly functional bowls and generously sized shelves are new to the range. These are only available together with the matching furniture in the range.

Neu im Sortiment sind die eleganten, feinen LAUFEN pro S Möbelwaschtische mit einem funktionalen, tiefen Becken und großzügigen Ablagen. Diese sind nur im Paket mit den dazu passenden Möbeln der Serie erhältlich.

Une nouveauté de l'assortiment: les élégants lavabos pour meubles LAUFEN pro S aux formes élancées avec une profonde vasque fonctionnelle et de grands espaces de rangement. Ces lavabos sont exclusivement disponibles en liaison avec les meubles assortis de la série.

La novità dell'assortimento è data dagli eleganti e raffinati lavabi consolle LAUFEN pro S, dal bacino profondo e funzionale e dalle ampie mensole, disponibili solamente in pacchetto insieme ai mobili abbinabili della serie.



LAUFEN PRO B





With LAUFEN pro B, LAUFEN has set a standard in the bathroom. The design has a broad appeal and relies upon sweeping curves which have proven their worth in the bathroom thanks to their body-friendly characteristics. The continuous edge around the washbasin provides high-quality functionality since it protects against overflows. With more than ten different sizes and special washbasin solutions – e.g. washbasin bowls, drop-in washbasins, and built-in washbasins – LAUFEN pro B meets all requirements placed upon a bathroom.

Mit LAUFEN pro B hat LAUFEN einen Standard im Bad gesetzt. Das mehrheitsfähige Design setzt auf runde, geschwungene Linien, die sich aufgrund ihrer körperfreundlichen Eigenschaften im Bad bewährt haben. Für hohe Funktionalität sorgt der umlaufende Rand, der vor überlaufendem Wasser schützt. Mit mehr als zehn verschiedenen Größen und speziellen Waschtisch-Lösungen – zum Beispiel Aufsatzwaschtische sowie unterbau- oder einbaufähige Waschtische – zeigt sich LAUFEN pro B allen Anforderungen im Bad gewachsen.

Avec LAUFEN pro B, LAUFEN a fixé une norme dans la salle de bain. Le design qui remporte une large adhésion mise sur des lignes arrondies et ondulées qui ont fait leur preuve dans la salle de bain en raison de leurs caractéristiques adaptées au corps. Le bord circulaire, qui empêche l'eau de déborder, assure une fonctionnalité exceptionnelle. Avec plus de dix tailles différentes et des solutions de lavabo spéciales, par exemple des lavabos à encastrer et à poser, LAUFEN pro B répond parfaitement à toutes les exigences posées à la salle de bain.

Con la serie LAUFEN pro B LAUFEN ha stabilito un nuovo standard per la stanza da bagno. Il design è in grado di incontrare il favore della maggioranza del pubblico e punta su linee arrotondate e curve che si sono ormai affermate nel bagno grazie alle loro ergonomicità. L'alta funzionalità è garantita dal bordo periferico e impedisce la fuoriuscita di acqua. Con più di dieci misure diverse e soluzioni speciali per lavabo, come ad esempio lavabi da appoggio e lavabi sottopiano o da incasso, la serie LAUFEN pro B soddisfa tutti i requisiti per il bagno.



1 Oval washbasin bowl on case wash-top with drawer element.
 Ovaler Aufsatz-Waschtisch auf case Waschtischplatte mit Schubladenelement.
 Lavabo à poser ovale sur plan de toilette case avec tiroirs.
 Bacinella ovale su piano d'appoggio case con cassetti sottolavabo.

2 Round washbasin bowl on case wash-top.
 Runder Aufsatz-Waschtisch auf case Waschtischplatte.
 Lavabo à poser rond sur plan de toilette case.
 Bacinella rotonda su piano d'appoggio case.

3 Compact washbasin 600×420 mm.
 Kompakter Waschtisch 600×420 mm.
 Lavabo compact 600×420 mm.
 Lavabo compatto 600x420mm.

4 Washbasin 600x480 mm with pedestal. A three-hole alternative is available instead of a single lever mixer.
 Waschtisch 600x480 mm mit Standsäule. Alternativ zur Einloch- gibt es die Dreiloch-Variante.
 Lavabo 600x480 mm avec colonne. Variante à trois trous en remplacement du mitigeur est disponible.
 Lavabo 600x480 mm con colonna. Disponibile anche versione con 3 fori invece di foro singolo.



5 Combination of vanity unit and Laufen pro B washbasin.
 Kombination aus Unterbaumöbel und Waschtisch Laufen pro B.
 Ensemble composé d'un meuble sous lavabo et d'un lavabo Laufen pro B.
 Combinazione di base sottolavabo et lavabo Laufen pro B.

6 Round built-in washbasin.
 Runder Einbauwaschtisch von unten.
 Lavabo rond à encastrier par-dessous.
 Lavabo rotondo da incasso.



LAUFEN PRO A





LAUFEN pro A is characterised by a reduced, right-angled design vocabulary which has established itself in bathrooms with higher design aspirations. An important design and functional characteristic of the washbasins is the continuous edge, which allows water that overflows to run back into the basin. Thanks to its wide portfolio – with more than 10 different sizes and special solutions such as washbasin bowls, drop-in washbasins, and built-in washbasins – LAUFEN pro A is the range of choice for the building industry and private homes.

LAUFEN pro A zeichnet sich durch eine reduzierte, rechteckige Formensprache aus, die sich in Badezimmern mit gehobenem Designanspruch etabliert hat. Wichtigstes Design- und Funktionsmerkmal der Waschtische ist der umlaufende Rand, der übergetretenes Wasser zurück ins Becken fließen lässt. Dank einer breiten Auswahl, die mehr als 10 verschiedene Größen sowie spezielle Lösungen wie Aufsatzwaschtische, unterbau- oder einbaufähige Waschtische umfasst, ist LAUFEN pro A erste Wahl im Objektbau aber auch in Privathaushalten.

LAUFEN pro A se caractérise par un langage formel réduit, à angles droits qui s'est établi dans les salles de bain aux exigences de design élevées. Une caractéristique esthétique et fonctionnelle importante des lavabos est le bord circulaire qui permet à l'eau qui déborde de s'écouler à nouveau dans la baignoire. Grâce à un choix élevé qui comprend plus de 10 tailles différentes ainsi que des solutions spéciales notamment les lavabos à encastrer et à poser, LAUFEN pro A représente le premier choix dans la construction industrielle mais aussi dans les ménages.

La serie LAUFEN pro A è caratterizzata da una forma rettangolare, ridotta, che si è affermata in bagni con standard di progettazione di alto livello. La caratteristica funzionale e di design principale dei lavabi è il bordo periferico, che fa ritornare nel bacino l'acqua che straripa. Grazie ad una vasta scelta che comprende più di 10 misure differenti, nonché soluzioni speciali come lavabi da appoggio, sottopiano o da incasso, la serie LAUFEN pro A rappresenta la prima scelta sia nell'edilizia che in ambito privato.





Please find information about **LCC Laufen Clean Coat** on page 52.

Informationen zu **LCC Laufen Clean Coat** finden Sie auf Seite 52.

Pour informations relatives à **LCC Laufen Clean Coat** voir sur page 52.

Per informazioni su **LCC Laufen Clean Coat** consultare pagina 52.

LAUFEN PRO WCS AND BIDETS



LAUFEN PRO S

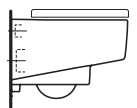
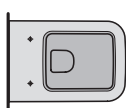

53 x 36 cm
rimless

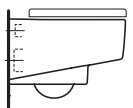

53 x 36 cm

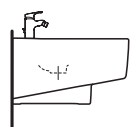

53 x 36 cm

LAUFEN PRO

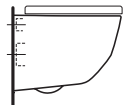
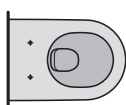

49 x 36 cm
rimless

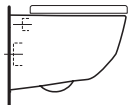

53 x 36 cm
rimless

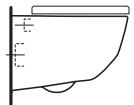

53 x 36 cm

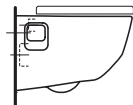

53 x 36 cm
rimless, with niches

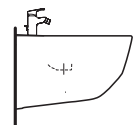

53 x 36 cm

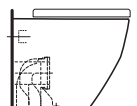

53 x 36 x 43 cm
rimless

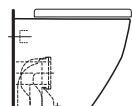

53 x 36 x 43 cm

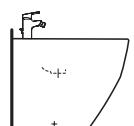

53 x 36 x 43 cm

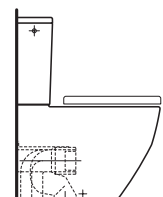

65 x 36 x 43 cm

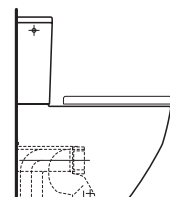

70 x 36 x 43 cm

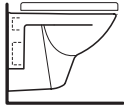
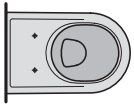

49 x 36 cm

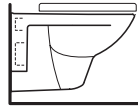

56 x 36 cm
rimless

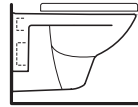

56 x 36 cm

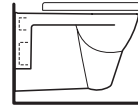

56 x 36 cm

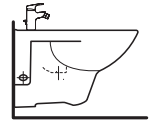

56 x 36 cm

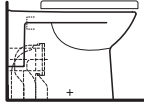

58 x 36 x 40 cm

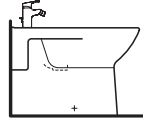

58 x 36 x 40 cm

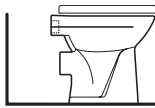

47 x 36 x 40 cm

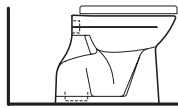

47 x 36 x 40 cm

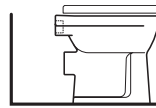

47 x 36 x 40 cm

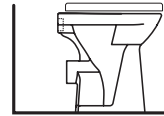

47 x 36 x 45 cm

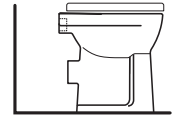

47 x 36 x 45 cm

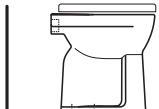

47 x 36 x 45 cm

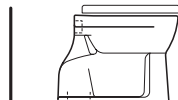

55 x 36 x 40 cm

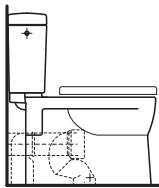

67 x 36 x 40 cm

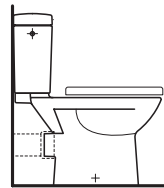

67 x 36 x 40 cm

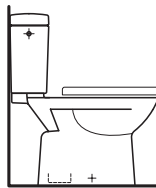

67 x 36 x 40 cm

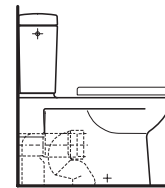

70 x 36 x 40 cm

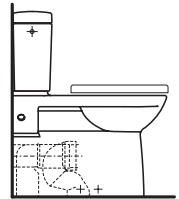

70 x 36 x 46 cm

LAUFEN PRO LIBERTY

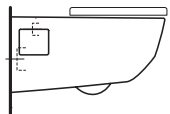
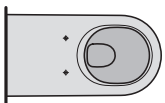

70 x 36 cm
rimless

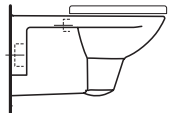
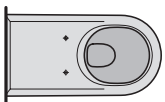

70 x 36 cm

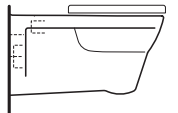

70 x 36 cm



LAUFEN PRO WCS AND BIDETS



The WCs and bidets in the LAUFEN pro range are suitable for all applications – most of which are equipped with an economical 4.5/3-litre flushing system. New is an additional version of LAUFEN's popular round rimless toilet, now with niches and LAUFEN's very flat LAUFEN pro slim toilet seat.

Zu LAUFEN pro gehören WCs und Bidets für jeden Anwendungsfall – die meisten mit sparsamer 4,5/3 l-Spülung. Neu ist eine Version des beliebten runden LAUFEN pro rimless WC, nun mit Nischen, sowie ein besonders flacher WC Sitz LAUFEN pro slim.

LAUFEN pro propose des WC et bidets adaptés à tous les besoins, la plupart équipés d'un système d'économie d'eau de 4,5/3 l. Les nouveautés sont un modèle du WC rond très apprécié LAUFEN pro sans bride et avec niches ainsi qu'un siège de WC particulièrement plat LAUFEN pro slim.

LAUFEN pro include vasi e bidet per ogni tipo di installazione; quasi tutti sono dotati di sistema di sciacquo a risparmio idrico da 4,5/3 litri. Nuova è una versione dell'apprezzato vaso circolare senza bordo di LAUFEN con nicchie e un sedile particolarmente piano LAUFEN pro slim.



Please find information about
LAUFEN EasyFit system

Pour informations relatives
à **LAUFEN EasyFit system**

Informationen zum **LAUFEN
EasyFit system** finden Sie

Per informazioni su **LAUFEN
EasyFit system** consultare



Shapely floorstanding cistern for back-to-wall floorstanding WCs.

Formschöner Universal Stand-Spülkasten für wandbündige Stand-WCs.

Beau réservoir au sol pour WC au sol dos au mur.

Cassetta di risciacquo a pavimento di bella forma per vaso a pavimento a filo muro.



Back-to-wall WC combination with LAUFEN pro seat and cover and vario outlet.

Wandbündige WC-Kombination mit LAUFEN pro Sitz und Deckel und Vario-Abgang.

Installation de WC dos au mur avec siège et abattant de WC LAUFEN pro set sortie Vario.

Vaso monoblocco a filo muro con nuovo sedile e coperchio LAUFEN pro e scarico Vario.



Compact WC rimless with 490 mm projection.

Compact WC rimless mit 490 mm Ausladung.

Compact WC rimless avec saillie de 490 mm.

Vaso Compact rimless con sporgenza di 490 mm.



Back-to-wall and floorstanding WC and bidet.

Wandbündiges und bodenstehendes WC und Bidet.

WC et bidet au sol et dos au mur.

Vaso e bidet a pavimento a filo muro.

Wall-hung WC and bidet with 560 mm projection. Universal WC toilet roll and brush holders in ceramic are also available.

Wand-WC und -Bidet mit 560 mm Ausladung. Universal WC-Rollen und Bürstenhalter aus Keramik sind ebenfalls erhältlich.

WC et bidet suspendus avec saillie de 560 mm. Des porte-papier et des porte-balai Universal en céramique sont également proposés.

Vaso e bidet sospesi con sporgenza di 560 mm. Sono disponibili anche il portascopino e il portarotolo Universal in ceramica.



Back-to-wall and floorstanding WC and bidet.

Wandbündiges und bodenstehendes WC und Bidet.

WC et bidet au sol et dos au mur.

Vaso e bidet a pavimento a filo muro.



Back-to-wall WC combination with Universal seat and cover and 305 mm vario outlet.

Wandbündige WC-Kombination mit Universal Sitz und Deckel und 305 mm-Vario-Abgang.

Installation de WC dos au mur avec siège et abattant de WC Universal et sortie Vario de 305 mm.

Vaso monoblocco a filo muro con sedile e coperchio Universal e scarico Vario da 305 mm.



Please find information about **Vario outlet** on page 54.

Informationen zur **Vario Abgang** finden Sie auf Seite 54.

Pour informations relatives à l'**évacuation Vario** voir sur page 54.

Per informazioni sul **scarico Vario** consultare pagina 54.



Compact dimensions, maximum comfort:
WC with 490 mm projection.

Kompakte Maße, maximaler Komfort:
WC mit 490 mm Ausladung.

Dimensions compactes, confort maximal:
WC avec saillie de 490 mm.

Dimensioni compatte, massima comodità:
vaso con sporgenza di 490 mm.



Renovation-friendly WC with raised and
normal seat position and horizontal outlet.

Renovierungsfreundliches WC mit erhöhter
und normaler Sitzposition und waagrechtem
Abgang.

WC pratique pour les rénovations avec posi-
tion assise normale et surélevée et sortie
horizontale.

Vaso di facile installazione con seduta norma-
le e rialzata e deflusso orizzontale.



Renovation-friendly WC with raised and
normal seat position and vertical outlet.

Renovierungsfreundliches WC mit erhöhter
und normaler Sitzposition und senkrechtem
Abgang.

WC pratique pour les rénovations avec posi-
tion assise normale et surélevée et sortie
verticale.

Vaso di facile installazione con seduta norma-
le e rialzata e deflusso verticale.

LAUFEN PRO RIMLESS WCS





Laufen Pro
8.2096.6



Laufen Pro compact
8.2096.5



Laufen Pro
with niches/mit Nischen/
avec niches/con nicchie
8.2096.4



Pro Liberty 70 cm
8.2196.0



Laufen Pro S
8.2096.2



Laufen Pro
8.2096.0 **NEW**



Laufen Pro
8.2295.6 **NEW**

Building on the success of its two well-established rimless toilets, LAUFEN has expanded its range of rimless toilets. All bowls of the LAUFEN pro rimless WCs have no rim. There's no longer anywhere for dirt and deposits to hide; instead, thanks to an innovative and powerful flushing system, everything's flushed cleanly away with both 6/3 litre and the 4.5/3 litre cistern. Both public toilets and private bathrooms can benefit from the easy cleaning and great hygiene of this system.

Zusätzlich zu den beiden bewährten und erfolgreichen LAUFEN pro rimless WCs erweitert LAUFEN das Sortiment an spülrandlosen WCs. Alle LAUFEN pro rimless WCs kommen ohne einen Spülrand aus. Schmutz und Anhaftungen finden hier keine Nische mehr, sondern werden dank eines innovativen, kraftvollen Spül-systems sowohl bei einer 6/3-Liter-Spülung als auch bei 4,5/3 Litern sauber weggespült. Von der vereinfachten Reinigung und dem Plus an Hygiene profitieren nicht nur öffentliche Sanitär-anlagen, sondern auch Privathaushalte.

En plus des deux WC LAUFEN pro sans bride à succès et qui ont fait leurs preuves, LAUFEN a agrandi la gamme avec des WC sans rebord de rinçage. Tous les WCs LAUFEN pro rimless fonctionnent sans rebord de rinçage. La saleté et les incrustations n'adhèrent plus, elles sont proprement rincées par un système de chasse d'eau puissant avec un volume de 6/3 litres ou 4,5/3 litres. Non seulement les installations sanitaires publiques, mais aussi les ménages en soi profitent du nettoyage simplifié et de l'hygiène accrue.

Oltre ai due popolari vasi LAUFEN pro rimless, LAUFEN amplia l'assortimento di vasi senza bordo di risciacquo. Tutti i vasi LAUFEN pro rimless sono senza brida. In questo modo la sporcizia e le incrostazioni non possono più aderire, ma vengono sciacquate perfettamente grazie ad un sistema di sciacquo potente e innovativo, sia da 6/3 litri che da 4,5/3 litri. La maggiore semplicità di pulizia e la maggiore igiene sono vantaggi importanti non solo negli impianti sanitari pubblici, ma anche in quelli domestici.

HOTEL SOLUTIONS

Practical solutions for hotel bathrooms.

Funktionelle Lösungen fürs Hotelbad.

Solutions fonctionnelles pour les salles de bains d'hôtel.

Soluzioni funzionali per i bagni degli hotel.





PUBLIC SPACES





Its durability and high function, low-cost maintenance and outstanding value for money make LAUFEN pro the obvious choice for public spaces.

Langlebigkeit und hohe Funktionalität, wirtschaftlicher Unterhalt und ein ausgezeichnetes Preis-Leistungsverhältnis machen LAUFEN pro zur ersten Wahl im öffentlichen Bereich.

Longue durée de vie et grande fonctionnalité, entretien économique et excellent rapport qualité-prix – LAUFEN pro est le premier choix pour tous les espaces publics.

Grazie all'elevata funzionalità, alla durata nel tempo, alla ridotta manutenzione e ad un ottimo rapporto qualità/prezzo, LAUFEN pro è la soluzione ideale per gli ambienti pubblici.



Washbasin LAUFEN pro S with sensor-controlled curvetronic faucet.

Waschtische LAUFEN pro S mit sensor-gesteuerter curvetronic Armatur.

Lavabos LAUFEN pro S avec robinetterie activée par capteur curvetronic.

Lavabi LAUFEN pro S con rubinetto a sensori curvetronic.



Washbasin LAUFEN pro B with sensor-controlled faucet.

Waschtische LAUFEN pro B mit sensor-gesteuerter Armatur.

Lavabos LAUFEN pro B avec robinetterie activée par capteur.

Lavabi LAUFEN pro B con rubinetto a sensori.



LAUFEN pro rimless WC with stable seat ring.

LAUFEN pro spülrandlos WC mit stabilem Sitzring.

LAUFEN pro rimless WC avec siège solide.

LAUFEN pro rimless WC con sedile robusto.



LAUFEN urinals for 'public' sector can be seen in a wide variety of public places.

The caprino urinal flushes reliably with just one litre of water – also sensor-controlled and optionally available with the hygienic LCC ceramic coating. Matching rion urinal division for privacy.

Urinale von LAUFEN aus dem Bereich «public» kommen an den unterschiedlichsten öffentlichen Orten vor.

Das Urinal caprino spült sicher mit nur einem Liter Wasser – auch sensorgesteuert und optional mit der hygienischen Keramikveredelung LCC. Dazu passend die Urinal-Trennwand rion, die vor neugierigen Blicken schützt.

On trouve les urinoirs de LAUFEN de la gamme «public» dans les lieux publics les plus variés.

L'urinoir caprino permet un rinçage performant avec un litre d'eau seulement. Il existe également activé par un capteur et en option avec l'apprêtage de céramique hygiénique LCC. Assortie à la gamme, la paroi de séparation pour urinoir rion, qui protège des regards indiscrets.

Gli orinatoi LAUFEN della gamma «public» sono presenti nei più diversi luoghi pubblici.

L'orinatoio caprino consente un risciacquo sicuro con un solo litro d'acqua – anche con comando a sensori e su richiesta con rivestimento igienico LCC. In abbinamento è disponibile l'aletta divisoria rion, che protegge da sguardi indiscreti.

LAUFEN PRO LIBERTY

Modern bathrooms suitable for wheelchair access translate convenience and function into good design. They play a considerable role in allowing people with special needs to lead more independent lives in their own homes.

LAUFEN pro liberty is an interesting proposition for private homes, hospitals, nursing and residential homes for the elderly. With its minimalist lines, it is perfectly matched to the LAUFEN pro bathroom suite series and, compliant with the standards, considerably increases comfort in bathroom use. LAUFEN pro liberty WC complies with DIN 18040 and SIA 521 500.

Moderne barrierefreie Bäder übersetzen Komfort und Funktion in gutes Design. Sie leisten einen wichtigen Beitrag zum selbstbestimmten Wohnen und Leben.

LAUFEN pro liberty ist für den Privathaushalt ebenso wie für Hospitäler, Pflege- und Seniorenheime eine interessante Lösung. Mit seiner reduzierten Linienführung passt es perfekt zur Komplettbadserie LAUFEN pro und macht die Badnutzung normgerecht erheblich komfortabler. Das LAUFEN pro liberty WC entspricht DIN 18040 und SIA 521 500.

Les salles de bains modernes accessibles aux personnes à mobilité réduite présentent à la fois confort et fonctionnalité dans un design agréable. Elles contribuent fortement à l'autonomie dans la vie quotidienne.

LAUFEN pro liberty est une solution intéressante aussi bien pour les particuliers que pour les hôpitaux, centres de soin et maisons de retraite. Avec ses lignes sobres, il se fond parfaitement dans la série complète LAUFEN pro et rend l'utilisation de la salle de bain nettement plus confortable tout en restant conforme aux normes posées. Le WC LAUFEN pro liberty respecte les normes DIN 18040 et SIA 521 500.

I nuovi bagni senza barriere architettoniche combinano comfort e funzionalità con un buon design e consentono un utilizzo autonomo anche da parte degli utenti con problemi motori.

LAUFEN pro liberty è una soluzione interessante per le abitazioni private, gli ospedali, le case di cura e le case di riposo per anziani. Con la sua linea sobria, si combina perfettamente con la serie completa da bagno LAUFEN pro e rende molto più confortevole l'utilizzo del bagno, in conformità dalle normative vigenti. LAUFEN pro liberty rispetta le norme DIN 18040 e SIA 521 500.

pro liberty WC also available as a rimless version.

pro liberty WC auch als rimless Version verfügbar.

WC pro liberty aussi disponible en version rimless.

WC pro liberty anche disponibile nella versione rimless.

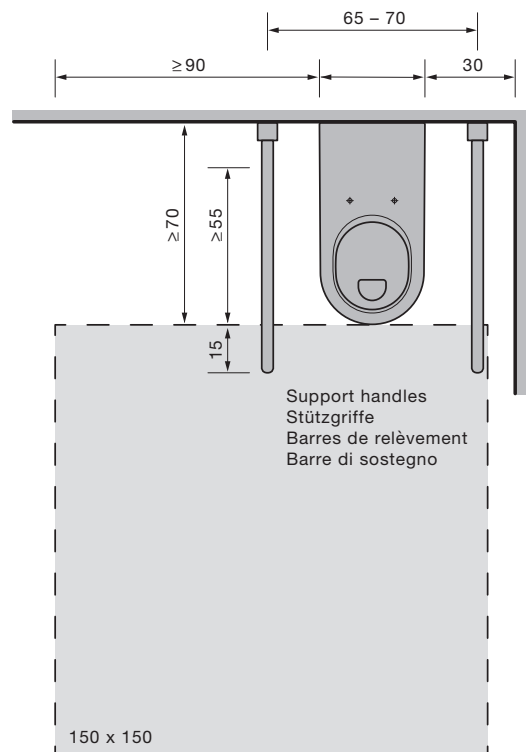





Wheelchair-ready washbasin offering disabled access according to DIN 18040, with or without overflow.

Unterfahrbarer Waschtisch barrierefrei nach DIN 18040, wahlweise mit oder ohne Überlauf.

Lavabo dégagé adapté aux personnes à mobilité réduite selon DIN 18040, au choix avec ou sans trop-plein.

Lavabo senza barriere architettoniche in conformità alla norma DIN 18040, a scelta con o senza troppopieno.

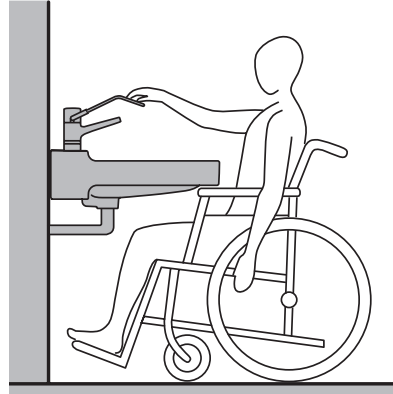

Ergonomic recessed handles on the underside of the washbasin help users pull themselves towards the washbasin and provide a secure hold.

Ergonomische Griffmulden am Waschtischboden für einfaches Heranziehen und Festhalten.

Poignées coquilles ergonomiques au pied du lavabo pour se hisser et se tenir en toute simplicité.

Maniglie ad incavo ergonomiche sul lato inferiore del lavabo per avvicinarsi e tenersi saldi facilmente.



Flushdown WC, 700 mm projection, offering disabled access according to DIN 18040 and SIA 521 500.

Tiefspüler-WC, 700 mm Ausladung, barrierefrei nach DIN 18040 und SIA 521 500.

WC à chasse directe, saillie de 700 mm, adapté aux personnes à mobilité réduite selon DIN 18040 et SIA 521 500.

Vaso a cacciata, sporgenza di 700 mm, senza barriere architettoniche in conformità alla norma DIN 18040 e SIA 521 500.

The WC seat position, raised by 6 cm, makes it easier for users to sit down and stand up, and allows correct posture when seated. It fits on standard connections (305 mm Vario).

Die um 6 cm erhöhte Sitzposition des WCs erleichtert das Hinsetzen und Aufstehen und ermöglicht eine körpergerechte Sitzhaltung. Es passt auf Standardanschlüsse (305 mm Vario).

La position assise du WC, surélevée de 6 cm, permet de s'asseoir et de se relever facilement et garantit un bon maintien du corps en position assise. Il est adapté aux raccords standard (305 mm Vario).

Grazie alla seduta del vaso rialzata di 6 cm, sedersi e rialzarsi è più facile e la posizione del corpo è più corretta. È predisposto per attacchi standard (305 mm Vario).



Standard
42 cm



Comfort
48 cm



FURNITURE



.463



.475



.479



.423



.480



.999

LAUFEN pro S

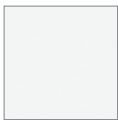

.463 White matt
Weiß matt
Blanc mat
Bianco opaco



.475 White glossy
Weiß glänzend
Blanc brillant
Bianco brillante



.423 Wenge
Wenge
Wengé
Wengé



.479 Bright oak
Eiche hell
Chêne clair
Rovere chiaro



.480 Graphite
Graphit
Graphite
Grafite

LAUFEN pro A + B

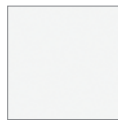

.463 White matt
Weiß matt
Blanc mat
Bianco opaco



.475 White glossy
Weiß glänzend
Blanc brillant
Bianco brillante



.423 Wenge
Wenge
Wengé
Wengé

LAUFEN pro S + A .999 Multicolor

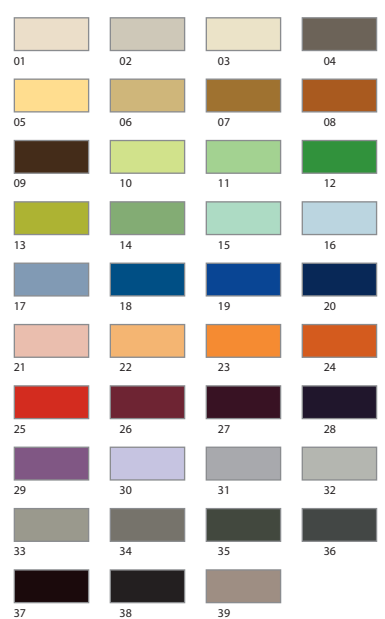



LAUFEN provides a wide range of colours for the LAUFEN pro furniture ranges using special matt paint finishes as well as the four standard decors: 39 colour tones especially created for LAUFEN allow the colours of your bathroom furniture to be coordinated with your bathroom.

Für die Möbelserie LAUFEN pro bietet LAUFEN eine große Farbauswahl an matten Sonderlacken zusätzlich zu den vier Standarddekoren: 39 eigens für LAUFEN kreierte Farbtöne ermöglichen die individuelle farbliche Abstimmung des Badmöbels auf ihr Bad.

Pour la série de meubles LAUFEN pro, LAUFEN propose un grand choix de couleurs de peinture spéciale satinée en plus des quatre décors standard: 39 couleurs spécialement créés pour LAUFEN permettent de coordonner individuellement les meubles à votre salle de bains.

Per le serie di mobili LAUFEN pro, LAUFEN offre una grande selezione di colori con vernici speciali opache oltre alle quattro decorazioni standard: 39 tonalità cromatiche create appositamente per LAUFEN permettono l'accordo cromatico dei mobili del bagno con il resto della vostra stanza.



The LAUFEN pro vanity units can optionally be fitted with a space-saving siphon. This dispenses with the need for siphon cut-outs in drawers, recovering valuable storage space.

Die LAUFEN pro Unterbaumöbel können optional mit einem platzsparenden Siphon ausgestattet werden. Er macht Siphon-Ausschnitte in den Schubladen überflüssig und bringt wertvollen Stauraum zurück.

Les meubles LAUFEN peuvent être munis en option d'un siphon prenant peu de place. Ce dernier rend superflues les découpes pour siphon dans les tiroirs, ce qui crée de la place de rangement supplémentaire.

Le basi sottolavabo LAUFEN possono essere dotati in maniera opzionale di un sifone salva-spazio, che rende superflui gli appositi tagli nei cassetti, consentendo un migliore sfruttamento del mobile.

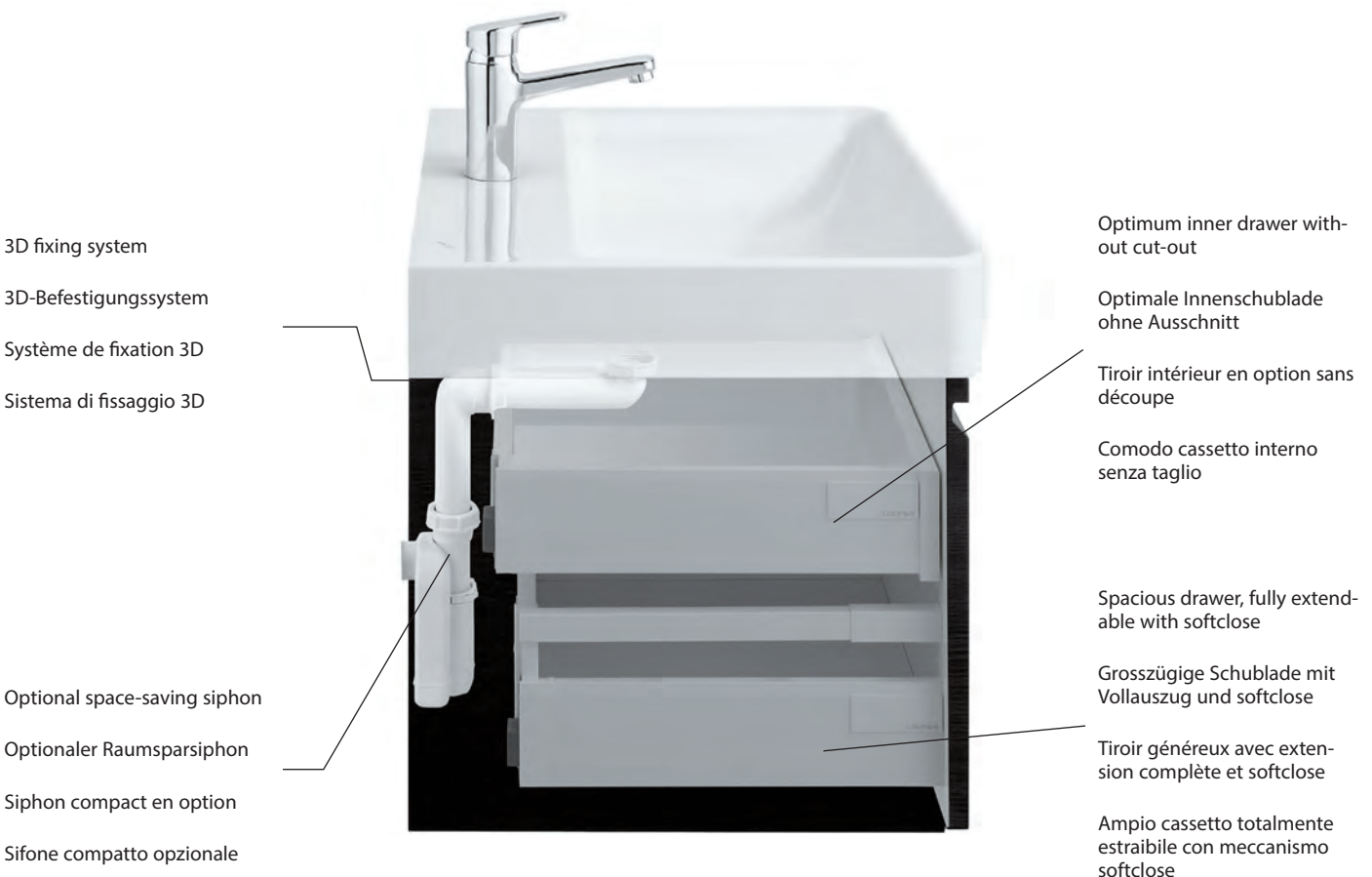

The integrated softclose mechanism and exclusive fittings ensure that drawers and doors always close gently and quietly.

Der integrierte softclose-Mechanismus und hochwertige Beschläge sorgen für dauerhaft sanftes und leises Schließen der Schubladen und Türen.

Le mécanisme intégré de softclose et les raccords de grande qualité garantissent une fermeture silencieuse des tiroirs et portes sur le long terme.

Il meccanismo softclose e le cerniere di alta qualità consentono di chiudere sempre i cassetti e le ante in modo delicato e silenzioso.

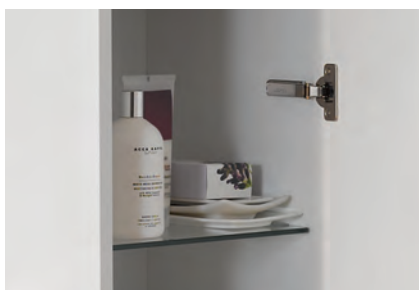

Please find information about **softclose** on page 56.

Informationen zur **softclose** finden Sie auf Seite 56.

Pour informations relatives à **softclose** voir sur page 56.

Per informazioni su **softclose** consultare pagina 56.

BATHTUBS



LAUFEN pro includes both acrylic and steel bathtubs. They are available in a wide range of sizes. To provide greater comfort, the acrylic bathtubs can also be equipped with the whirl system.

Zu LAUFEN pro gehören sowohl Acryl- als auch Stahlbade-
wannen. Sie sind in vielen Größen erhältlich. Für gehobenen
Komfort können die Acrylwannen auch mit Whirlsystem ausge-
stattet werden.

Aussi bien des baignoires en acrylique qu'en acier font partie
de LAUFEN pro. Elles sont disponibles dans de nombreuses
tailles. Les baignoires en acrylique peuvent être également
équipées du système balnéo pour un confort absolu.

La serie LAUFEN pro comprende le vasche da bagno in acrilico
e acciaio. Le vasche da bagno sono disponibili in molte misure.
Per aumentare il comfort, le vasche da bagno in acrilico posso-
no anche essere equipaggiate con sistema idromassaggio.



Please find information about **bathtub materials** on page 57.

Informationen zu **Wannenmaterialien** finden Sie auf Seite 57.

Pour informations sur les **matériaux de baignoire** voir sur page 57.

Per informazioni sui materiali delle **vasche da bagno**, consultare la pagina 57.

EUROPEAN WATER LABEL

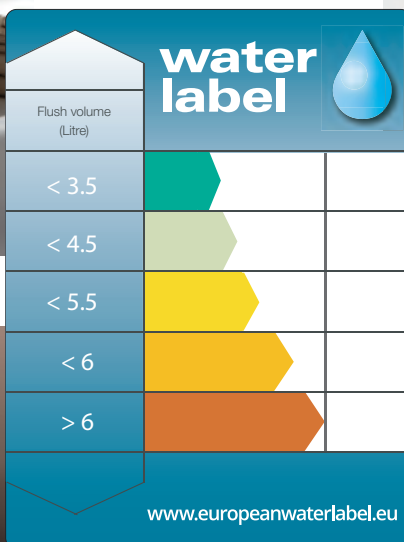

NUMEROUS LAUFEN PRODUCTS CERTIFIED

As a company that makes water accessible to people in their bathrooms, LAUFEN is committed to the responsible use of this precious resource. Therefore LAUFEN has had a wide range of its products, from basins to showers, to faucets and toilets, certified by the European Water Label, achieving classifications from above average to very good. With the database of the European Water Label, architects, planners and consumers have a Europe-wide comparison tool at hand, enabling them to assess the water consumption of bathroom and kitchen products at a glance.

ZAHLEICHE LAUFEN PRODUKTE ZERTIFIZIERT

Als Unternehmen, das dem Menschen das Wasser im Bad nutzbar macht, sieht sich LAUFEN dem verantwortungsvollen Umgang mit dieser kostbaren Ressource verpflichtet. Deshalb hat LAUFEN eine breite Produktpalette von Waschtisch- über Duscharmaturen bis hin zu WCs mit dem European Water Label zertifizieren lassen, die überdurchschnittlich gut bis sehr gut eingestuft wurden. Mit der Datenbank des European Water Label haben Architekten, Planer und Verbraucher ein europaweit gültiges Vergleichswerkzeug an der Hand, mit dem sie den Wasserverbrauch eines wasserführenden Produkts in Bad oder Küche auf einen Blick beurteilen können.

DE NOMBREUX PRODUITS LAUFEN SONT CERTIFIÉS

En tant qu'entreprise qui permet aux gens d'utiliser de l'eau dans leur salle de bain, LAUFEN s'engage à agir avec responsabilité avec cette précieuse ressource. C'est la raison pour laquelle LAUFEN a fait certifier une large palette de produits allant des lavabos aux WC en passant par les robinetteries de douche avec le European Water Label, qui ont été classés étant entre supérieurs à la moyenne à de très bonne qualité. Avec la base de données du projet European Water Label, les architectes, les planificateurs et les consommateurs ont un outil de comparaison valable dans toute l'Europe à disposition avec lequel ils peuvent estimer la consommation d'eau d'un produit alimentant une salle de bain ou une cuisine en eau.

CERTIFICAZIONE PER NUMEROSI PRODOTTI DI LAUFEN

In quanto azienda che rende disponibile l'acqua nel bagno per le persone, LAUFEN si ritiene obbligata a gestire in modo responsabile questa preziosa risorsa. È per questo che LAUFEN ha fatto certificare con l'European Water Label una vasta gamma di prodotti, dai rubinetti per lavabo a quelli per doccia e ai vasi, che hanno tutti ricevuto valutazioni superiori alla media, da buono a molto buono. Con il database dell'European Water Label architetti, progettisti e consumatori hanno a disposizione uno strumento di confronto valido a livello europeo con il quale possono valutare con un solo sguardo il consumo d'acqua di un prodotto da bagno a da cucina che utilizza acqua.

FEATURES AND BENEFITS: SANITARY WARE

The latest generation of LAUFEN **water-saving WCs** is optimised to flush with two reduced flushing volumes: 4.5 or 3 litres of water. Compared to today's 6/3 litre dual flush or 6 litre single flush standard, these new models provide substantial water savings.

LAUFEN products marked with the green 4.5/3L logo are not only fulfilling the requirements defined in the harmonized standard EN 997 Class 1 Type 5 and Class 2 (that cover the whole European territory), but also fulfill the challenging Australian requirements of SAI/Wells 4 Stars.

In order to achieve this water saving the LAUFEN floorstanding WC combination shall be combined with its dedicated cistern having the option .75x. LAUFEN wall-hung or floor-standing WCs shall be combined with any concealed cistern, locally available and approved for 4.5/3 litre flushing. Please note that a suitable downstream drainage system must be built for this kind of water-saving WCs. In case of restrictions of the existing drainage system or local regulations LAUFEN WCs marked with the green 4.5/3L logo can also be flushed with standard 6 litre flushing volume.

Die neueste Generation von LAUFEN **Wasserspar-WCs** ist auf das Spülen im Zweimengen-Spülsystem mit 4,5 bzw. 3 Litern optimiert. Gegenüber den in Bestandgebäuden meistens verwendeten Versionen mit 6/3L oder 6L Spülung erreichen diese Modelle eine erhebliche Einsparung. LAUFEN erfüllt mit den mit einem grünen 4,5/3L Logo markierten Produkten nicht nur die geltenden Normen nach EN 997 Class 1 Type 5 und EN 997 Class 2 (europäischer Raum), sondern auch die in anderen Ländern geltenden Vorgaben (u.a. die australischen SAI/Wells 4-Zertifikate). Um diese Wassereinsparung zu erreichen, müssen die LAUFEN Stand-WC-Kombinationen mit Spülkästen der Option .75x kombiniert werden. LAUFEN Wand- oder Stand-WCs können mit jedem Unterputz-Spülkasten kombiniert werden, der die 4,5/3L Norm erfüllt. Zu beachten ist dabei, dass das Abwassersystem des Gebäudes auf diese Wasserspar-WCs ausgelegt sein muss. Im Falle einer Einschränkung durch das Abwassersystem oder durch lokale gesetzliche Bestimmungen, können LAUFEN WCs mit dem 4,5/3L Logo auch mit 6-L Spülung betrieben werden.

La dernière génération des **WC économes en eau** LAUFEN est optimisée pour le système de rinçage à deux quantités avec 4,5 ou 3 litres. Par rapports aux versions utilisées le plus souvent dans les bâtiments existants avec un rinçage de 6/3 litres ou de 6 litres, ces modèles permettent une économie importante.

Avec les produits marqués d'un logo vert 4,5/3 litres, LAUFEN ne satisfait pas seulement aux normes en vigueur selon EN 997 classe 1 type 5 et EN 997 classe 2 (espace européen) mais également aux spécifications valables dans d'autres pays (notamment aux certificats australiens SAI/Wells 4). Afin d'atteindre cette économie d'eau, les combinaisons des WC sur socle LAUFEN doivent utiliser des réservoirs de l'option .75x. Les WC suspendus ou sur socle LAUFEN peuvent être combinés avec tous les réservoirs encastrés qui répondent à la norme 4,5/3 litres. Il faut savoir à ce sujet que le système d'évacuation du bâtiment doit être dimensionné en fonction de ces WC économes en eau. En cas de restriction relative au système d'évacuation ou aux dispositions locales en vigueur, les WC LAUFEN munis du logo 4,5/3 litres peuvent être également exploités avec un rinçage de 6 litres.

La nuova generazione di **WC a risparmio idrico** LAUFEN ottimizza lo sciacquone attraverso un sistema a duplice quantità da 4,5 o 3 litri. Rispetto alle versioni per lo più utilizzate negli edifici esistenti, con sciacquoni da 6/3 litri o 6 litri, questi modelli consentono un notevole risparmio. I prodotti contrassegnati con un logo verde da 4,5/3 litri della serie LAUFEN non solo soddisfano le norme applicabili a sensi della EN 997 Classe 1 tipo 5 e EN 997 Classe 2 (ambito europeo), bensì anche le prescrizioni applicabili in altri paesi (compresi i certificati australiani SAI/Wells 4). Per ottenere questo risparmio d'acqua, i vasi monoblocco a pavimento LAUFEN devono essere abbinati alle cassette di sciacquo dell'opzione da .75x. I vasi sospesi o i vasi monoblocco a pavimento della serie LAUFEN possono essere combinati con qualsiasi cassetta di sciacquo da incasso, che soddisfa lo standard 4,5/3 litri. Occorre tenere in considerazione che il sistema di acqua di scarico dell'edificio deve essere concepito appositamente per questo WC a risparmio idrico. In caso di limitazioni dovute alla rete di fognatura o alle disposizioni locali in vigore, i WC della serie LAUFEN con il logo da 4,5/3 litri possono essere utilizzati anche con sciacquoni da 6 litri.

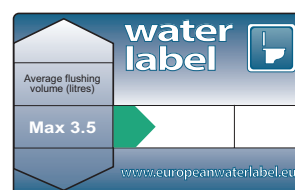

FEATURES AND BENEFITS: SANITARY WARE

LCC stands for **Laufen Clean Coat**. This innovative ceramic surface finish is a vitreous silicate ceramic coating on top of the original glaze. LCC is an extremely hard, indeed almost indestructible indivisible part of the ceramic object to which it is applied.

The benefits of this process: With a roughness of only 4 nanometers, LCC is entirely free of pores. Thanks to this feature, lime, dirt and bacteria have practically nowhere to gain a foothold – and even if they do, they can be removed much more easily. A hydrophilic effect caused by the material ensures that dirt particles are more easily washed away on flushing. In addition, cleaning and disinfection fluids spread over the surface more easily and thus work more effectively. This is an ideal solution for the rigorous demands of everyday cleaning – for example in hotels or clinics.

LCC steht für **Laufen Clean Coat**. Diese innovative Keramik-Oberflächenveredelung ist ein silikatkeramischer, glasartiger Überzug über die Originalglasur. Als untrennbarer Bestandteil der Keramik ist LCC extrem hart und nahezu unverwundlich. Die Vorteile dieses Verfahrens: LCC ist mit einem Rauheitswert von nur vier Nanometern porenfrei. Dank dieser Eigenschaft finden Kalk, Schmutz und Bakterien kaum Halt – und wenn doch, dann lassen sich Verschmutzungen wesentlich leichter wieder entfernen. Es tritt ein hydrophiler Effekt auf, der dafür sorgt, dass beim Abspülen Schmutzpartikel leichter weggespült werden. Auch Reinigungs- und Desinfektionsmittel verteilen sich einfacher und wirken somit effizienter. Eine ideale Lösung für den harten Reinigungsalltag – beispielsweise in Hotels oder Kliniken.



The innovative glazing for durable hygiene.
Die innovative Glasur für dauerhafte Hygiene.
L'émail innovant pour l'hygiène durable.
Lo smalto innovativo per un'igiene duratura.



LCC est l'abréviation de la désignation **Laufen Clean Coat**. Ce traitement innovant de la surface céramique consiste en un revêtement céramique à base de silicate vitreux sur le vernis d'origine. Le revêtement LCC fait partie intégrante de la céramique et en tant que tel, est extrêmement résistant et pratiquement inusable.

Les avantages de ce procédé: avec une valeur de rugosité de seulement quatre nanomètres, le LCC est exempt de pores. Grâce à cette propriété, le calcaire, les particules de saleté et les bactéries n'adhèrent pas – et même lorsque c'est le cas, les saletés sont bien plus faciles à retirer. Un effet hydrophile agit de sorte que les particules de saleté partent plus facilement au rinçage. Les produits de nettoyage et de désinfection s'étalent plus facilement et agissent ainsi de manière plus efficace. Une solution idéale pour répondre aux sollicitations impitoyables que représente le nettoyage quotidien – par exemple dans les hôtels ou les cliniques.

LCC significa **Laufen Clean Coat**. Questa preziosa innovazione fornisce alla ceramica un rivestimento a base di silicati sopra lo smalto originale. Essendo un componente inseparabile della ceramica, LCC risulta estremamente duro e pressoché indistruttibile.

I vantaggi di questo procedimento: con una ruvidità di soli quattro nanometri LCC è del tutto privo di pori. Grazie a questa caratteristica lo sporco, il calcare e i batteri non fanno presa e sono quindi molto facili da rimuovere, anche solo con l'acqua. L'effetto idrofilo che si verifica consente di lavare via più facilmente le particelle di sporco con un semplice risciacquo. Una soluzione ideale per la faticosa pulizia quotidiana, ad esempio in hotel o nelle cliniche.



German
Design Award
NOMINEE 2013



material
design award

2012

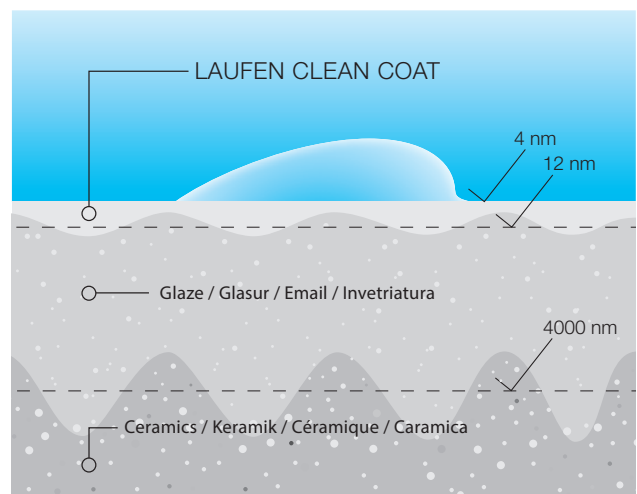



LAUFEN has developed the revolutionary wall mounting system **EasyFit** for WCs, bidets and urinals. A patent has been lodged. The invisible, easy to mount fixation system meets the needs of both fitters and end users. For example, end users are impressed by a ceramic WC with a flawless surface which is really easy to clean since there's nowhere for dirt to hide. Fitters are enthusiastic about the time-saving, intuitive mounting system.

LAUFEN hat das revolutionäre Wand-Montagesystem **EasyFit** für WCs, Bidets und Urinale entwickelt und zum Patent angemeldet. Diese unsichtbare und einfach zu montierende Befestigung entspricht den Bedürfnissen von Installateuren und Endanwendern gleichermaßen. Die Endanwender freuen sich zum Beispiel über ein Keramik-WC, dessen makellose Oberfläche sich mühelos reinigen lässt, da der Schmutz keinen Halt in Nischen findet. Die Installateure begeistern sich für das zeitsparende, selbst-erklärende Montagesystem.

LAUFEN a développé le système de montage mural révolutionnaire **EasyFit** pour WC, bidets et urinoirs et a déposé un brevet pour celle-ci. Cette fixation facile à monter et invisible satisfait aux exigences des installateurs et de l'utilisateur final. L'utilisateur final apprécie par ex. d'avoir acheté un WC en céramique, dont la surface irréprochable se nettoie sans peine, étant donné que la saleté n'adhère plus dans les coins. Les installateurs apprécient le système de montage rapide et intuitif.

LAUFEN ha messo a punto il rivoluzionario sistema di fissaggio a parete **EasyFit** (in fase di brevetto) per vasi, bidets ed orinatoi. Questo sistema di fissaggio invisibile e facile da montare soddisfa in egual misura le esigenze degli installatori e degli utenti finali.

L'utente finale sarà sicuramente soddisfatto di un vaso in ceramica estremamente facile da pulire, in quanto la sporcizia non riesce ad aderire nelle nicchie. Gli installatori invece apprezzeranno la possibilità di risparmiare tempo con questo sistema di montaggio autoesplicativo.



FEATURES AND BENEFITS: SANITARY WARE

Thanks to our convenient **lowering system** many of our WC covers and seats close gently and quietly. For easier cleaning, all LAUFEN seats can be removed with a simple hand movement. LAUFEN seats have been comprehensively tested: amongst others the test includes opening and closing 50,000 times.

LAUFEN WC-Sitze und -Deckel bieten dem Anwender viele Vorteile: So können alle WC-Sitze von LAUFEN für eine einfache und gründliche Reinigung mit einem Handgriff abgenommen werden. Umfangreiche Tests, zum Beispiel 50.000-faches Öffnen und Schließen, bürgen für beste Qualität. Und viele WC-Sitze und -Deckel von LAUFEN schließen dank komfortabler **Absenkautomatik** sanft und leise.

Grâce à leur confortable **abaissement automatique**, de nombreux sièges et abattants de WC LAUFEN descendent lentement et en silence sur la cuvette. Et pour qu'on puisse les nettoyer sans peine, siège et abattant s'enlèvent en un tour de mains. Les sièges de WC LAUFEN sont soumis à des tests très complets: entre autres, le test comportant 50 000 ouvertures et fermetures.

Grazie al **sistema di caduta rallentata** molti coperchi e sedili per WC di LAUFEN si chiudono in modo delicato e silenzioso. Per una pulizia agevole, tutti i sedili per WC LAUFEN sono rimovibili con un semplice movimento. I sedili per WC LAUFEN vengono testati in modo particolarmente accurato: tra l'altro devono superare un test consistente in 50.000 aperture e chiusure.



The installation dimensions of WCs are not always identical: In many renovation situations the LAUFEN **Vario outlet** can make it easier to connect the WC to the sewage network. Both horizontal and vertical outlet wall clearances of up to 350 mm for washout and 305 mm for washdown are possible.

Die Anschlussmaße von WCs sind nicht immer gleich: In vielen Renovierungssituationen erleichtert der **Vario-Abgang** von LAUFEN den sicheren Anschluss des WCs an das Abwassernetz. Sowohl ein waagrechtler als auch ein senkrechter Abgang mit Wandabständen bis zu 350 mm beim Flach- und 305 mm beim Tiefspüler sind damit möglich.

Les dimensions de raccordement des WC ne sont pas toujours les mêmes: dans de nombreuses situations de rénovation, la **sortie Vario** de LAUFEN permet le raccordement en toute sécurité du WC au réseau d'évacuation. Elle permet aussi bien une sortie horizontale que verticale avec des distances par rapport au mur allant jusqu'à 350 mm pour la chasse à fond plat et 305 mm pour la chasse directe.

Le misure di attacco dei WC non sono sempre identiche: In diverse situazioni di ristrutturazione lo **scarico Vario** di LAUFEN facilita l'attacco sicuro del WC alla rete di acque reflue. Sono pertanto possibili sia uno scarico verticale sia uno orizzontale con distanze massime dalle pareti pari a 350 mm a fondo piatto e a 305 mm a cacciata.



The bowl of the new **LAUFEN pro rimless WC** has no rim. There's no longer anywhere for dirt and deposits to hide; instead, thanks to an innovative and powerful flushing system, everything's flushed cleanly away with both the 6/3-litre version and the 4.5/3 litre version. Both public toilets and private bathrooms can benefit from the easy cleaning and great hygiene of this system.

Das neue **LAUFEN pro rimless WC** kommt ohne einen Spülrand aus. Schmutz und Anhaftungen finden hier keine Nische mehr, sondern werden dank eines innovativen, kraftvollen Spülsystems sowohl bei einer 6/3-Liter-Spülung als auch bei 4,5/3 Litern sauber weggespült. Von der vereinfachten Reinigung und dem Plus an Hygiene profitieren nicht nur öffentliche Sanitäreanlagen, sondern auch Privathaushalte.

La nouvelle **toilette LAUFEN pro rimless** fonctionne sans rebord de rinçage. La saleté et les incrustations n'adhèrent plus, elle sont proprement rincées par un système de chasse d'eau puissant autant avec un volume de 6/3 litres qu'avec 4,5/3 litres. Non seulement les installations sanitaires publiques, mais aussi les ménages en soi profitent du nettoyage simplifié et de l'hygiène accrue.

Il nuovo vaso **LAUFEN pro rimless** è senza brida. In questo modo lo sporco e le incrostazioni non possono più aderire, ma vengono eliminate perfettamente grazie ad un sistema innovativo di potente risciacquo, sia da 6/3 litri che 4,5/3 litri. La maggiore semplicità di pulizia e la maggiore igiene sono vantaggi importanti non solo negli impianti sanitari pubblici, ma anche in quelli domestici.



FEATURES AND BENEFITS: FURNITURE

Slamming of doors is not inevitable: At LAUFEN, **softclose** means gently-closing furniture doors and drawers. The system is integrated as standard into all LAUFEN furniture. In this case, quality can be felt and not heard.

Türenschiagen muss nicht sein: **softclose** steht bei LAUFEN für gedämpfte Möbeltüren und Schubladen und ist standardmäßig in allen LAUFEN Möbeln umgesetzt. Hier wird Qualität spür- und eben nicht mehr hörbar.

Claquer les portes n'est pas une fatalité: chez LAUFEN, la désignation **softclose** est synonyme de technique de fermeture en douceur des portes et des tiroirs. Cette technique équipe en série tous les meubles LAUFEN. Ici la qualité est perceptible mais inaudible.

La porta non deve sbattere: **softclose** viene utilizzato da LAUFEN per le porte dei mobili e per i cassetti ammortizzati ed è uno standard applicato a tutti i mobili LAUFEN. In questo modo la qualità diventa evidente ma silenziosa.



Comfort in every detail: The flexible and adjustable **3D mounting system** makes installation of LAUFEN furniture on the wall quick and easy.

Komfort bis ins Detail: Mit einem flexibel einstellbaren **3D-Befestigungssystem** ist die Wandmontage der LAUFEN Möbel unkompliziert und schnell.

Le confort jusque dans les détails: avec un **système de fixation à réglage modulaire 3D**, le montage mural des meubles LAUFEN est simple et rapide.

Comfort fin nei minimi dettagli. Con un flessibile **sistema di fissaggio 3D** regolabile il montaggio a parete dei mobili LAUFEN risulta semplice e rapido.



FEATURES AND BENEFITS: BATHTUBS

In order to be able to provide the right solution for all situations, LAUFEN offers in the LAUFEN pro series bathtubs in two different materials. When choosing the **bathtub material** the choice depends on individual preference and intended use.

Acrylic bathtubs:

bathtubs made of sanitary acrylic have benefits due to the insulating properties of the material and its warm surface. Together with an underlay made of hard foam, the material helps your bath water retain its temperature for a long time. LAUFEN sanitary acrylic is integrally coloured, is light- and colour-fast and easy to clean.

Steel bathtubs:

bathtubs in enamelled steel are hygienic, and resistant to acid, scratching, impacts and abrasion. LAUFEN steel bathtubs are produced using heavy 3 and 3.5 mm enamelled steel; they are extremely dimensionally stable and come with an anti-slip coating. In addition, they can be fitted with a structural sound insulation system.

Um in allen Fällen die richtige Lösung anzubieten, bietet LAUFEN in der Serie LAUFEN pro zwei verschiedene Wannenmaterialien. Bei der Wahl des **Wannenmaterials** ist die Entscheidung abhängig von der individuellen Präferenz und dem geforderten Anwendungsfall.

Acryl-Badewannen:

Badewannen aus Sanitäracryl haben ihre Vorteile in der guten Isolationsfähigkeit des Werkstoffs und seiner warmen Oberfläche. Zusammen mit einem Wannenträger aus Hartschaumstoff hält das Badewasser darin lange Zeit seine Temperatur. LAUFEN Sanitäracryl ist durchgefärbt, licht- und farbecht, sowie reinigungsfreundlich.

Stahl-Badewannen:

Badewannen aus emailliertem Stahl sind hygienisch, säurebeständig, kratz-, schlag- und abriebfest. LAUFEN Stahlwannen werden aus schwerem 3 und 3,5 mm dickem Stahl-Email gefertigt, sind extrem formstabil und mit der Antislip-Beschichtung erhältlich. Zudem verfügen sie über einen konstruktiven Schallschutz.

Pour offrir la bonne solution dans tous les cas, LAUFEN propose deux différents matériaux de baignoire dans la série LAUFEN pro. Le choix **des matériaux de baignoire** se fait en fonction des préférences individuelles et du cas d'application exigé.

Baignoires acryliques:

L'avantage des baignoires en acrylique sanitaire tient à la bonne capacité d'isolation de ce matériau et à sa surface chaude. En combinaison avec un support de baignoire en mousse rigide, l'eau du bain conserve longtemps sa température. L'acrylique sanitaire LAUFEN est teintée dans la masse, sa couleur grand teint résiste à la lumière, et est facile à nettoyer.

Baignoires en acier:

Les baignoires en acier émaillé sont hygiéniques, résistants aux acides, aux rayures et à l'abrasion. Les baignoires en acier LAUFEN sont fabriquées en acier émaillé d'une épaisseur de 3 et 3,5 mm, elles sont indéformables et disponibles avec le revêtement antislip. Elles possèdent en outre une isolation acoustique.

Per offrire sempre la soluzione più adatta, LAUFEN offre le sue vasche della serie LAUFEN pro in due materiali diversi. Nella scelta **del materiale delle vasche da bagno** la decisione dipende dalle preferenze individuali e dagli ambiti di applicazione.

Vasche da bagno in acrilico:

Le vasche da bagno di acrilico sanitario hanno il loro punto di forza nella buona capacità di isolamento del materiale e nella loro superficie calda. Insieme a un supporto di materiale espanso, l'acqua del bagno mantiene per lungo tempo la sua temperatura. L'acrilico sanitario LAUFEN è colorato, adatto alla luce e ad ambienti vivaci ed è facile da pulire.

Vasche da bagno in acciaio:

Le vasche da bagno in acciaio smaltato sono igienici, resistenti agli acidi, antigraffio, antiurto e antiabrasione. Le vasche in acciaio LAUFEN sono fabbricate in acciaio smaltato con spessore di 3 e 3,5 mm, sono estremamente stabili e disponibili con rivestimento antiscivolo. Inoltre dispongono di una protezione acustica integrata.





81596.0 ○/●
Small washbasin, asymmetric
 Handwaschbecken, asymmetrisch
 Lave-mains, asymétrique
 Lavamani, asimmetrico

Options:
 .104 .109

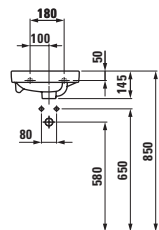
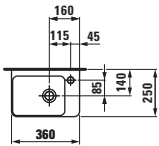

81595.4 ○/●
Small washbasin, asymmetric right
 Handwaschbecken, asymmetrisch rechts
 Lave-mains, asymétrique droit
 Lavamani, asimmetrico destro

Options:
 .104 .109

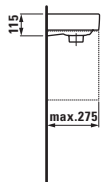
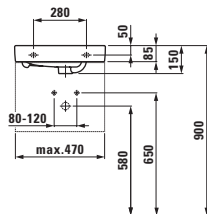
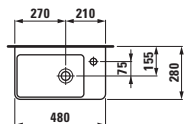

81595.5 ○/●
Small washbasin, asymmetric left
 Handwaschbecken, asymmetrisch links
 Lave-mains, asymétrique gauche
 Lavamani, asimmetrico sinistro

Options:
 .104 .109

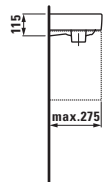
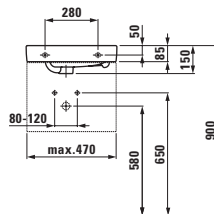
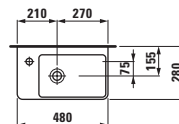

81596.1 ○/●
Small washbasin
 Handwaschbecken
 Lave-mains
 Lavamani

81696.1 ○/●
Small washbasin, undersurface ground
 Aufsatz-Handwaschbecken, wandmontiert
 Lave-mains, face inférieure meulée
 Lavamani, superficie inferiore levigata

Options:
 .104 .109 .111 .112 .142 .156

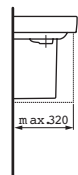
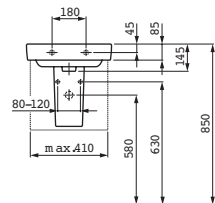
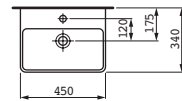

LAUFEN PRO S



81096.2 ○/●/●●●
Washbasin
 Waschtisch
 Lavabo
 Lavabo

81696.2 ○/●/●●●
Washbasin, undersurface ground
 Aufsatz-Waschtisch, wandmontiert
 Lavabo, face inférieure meulée
 Lavabo, superficie inferiore levigata

Options:
 .104 .108* .109 .111 .112 .136 .142
 .156 .158*
 (*not available with siphon cover)
Furniture:
 48335.1/2

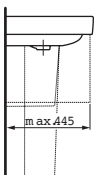
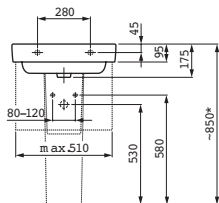
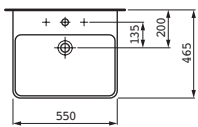

81096.3 ○/●/●●●
Washbasin
 Waschtisch
 Lavabo
 Lavabo

81696.3 ○/●/●●●
Washbasin, undersurface ground
 Aufsatz-Waschtisch, wandmontiert
 Lavabo, face inférieure meulée
 Lavabo, superficie inferiore levigata

Options:
 .104 .108* .109 .111 .112 .136 .142
 .156 .158*
 (*not available with siphon cover)
Furniture:
 48337.1/2

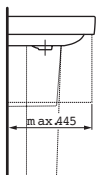
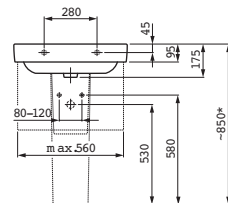
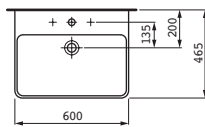

81096.4 ○/●/●●●
Washbasin
 Waschtisch
 Lavabo
 Lavabo

81696.4 ○/●/●●●
Washbasin, undersurface ground
 Aufsatz-Waschtisch, wandmontiert
 Lavabo, face inférieure meulée
 Lavabo, superficie inferiore levigata

Options:
 .104 .108* .109 .111 .112 .136 .142
 .156 .158*
 (*not available with siphon cover)
Furniture:
 48342.1/2

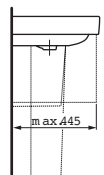
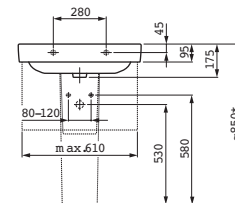
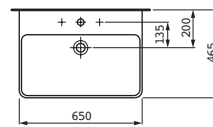

81096.7 ○/●/●●●
Washbasin
 Waschtisch
 Lavabo
 Lavabo

81696.7 ○/●/●●●
Washbasin, undersurface ground
 Aufsatz-Waschtisch, wandmontiert
 Lavabo, face inférieure meulée
 Lavabo, superficie inferiore levigata

Options:
 .104 .108* .109 .111 .112 .136 .142
 .156 .158*
 (*not available with siphon cover)
Furniture:
 48345.1/2

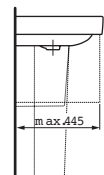
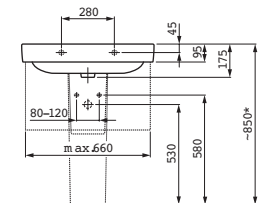
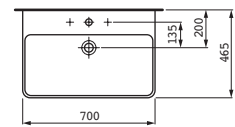



81396.5 ○/●/●●●
Countertop washbasin
 Waschtisch, unterbaufähig
 Lavabo à poser sur meuble
 Lavabo consolle

88596.0
Towel frame
 Handtuchrahmen
 Tablier pour serviette
 Portasalviette

81696.5 ○/●/●●●
Washbasin, undersurface ground
 Aufsatz-Waschtisch, wandmontiert
 Lavabo, face inférieure meulée
 Lavabo, superficie inferiore levigata

Options:
 .104 .108* .109 .111 .112 .136 .158*
 (*not available with siphon cover)

Furniture:
 48350.1/2

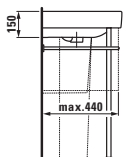
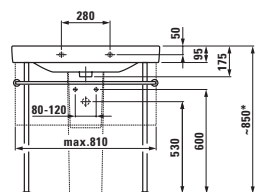
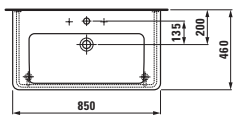

81396.6 ○/●/●●●
Countertop washbasin
 Waschtisch, unterbaufähig
 Lavabo à poser sur meuble
 Lavabo consolle

88596.1
Towel frame
 Handtuchrahmen
 Tablier pour serviette
 Portasalviette

81696.6 ○/●/●●●
Washbasin, undersurface ground
 Aufsatz-Waschtisch, wandmontiert
 Lavabo, face inférieure meulée
 Lavabo, superficie inferiore levigata

Options:
 .104 .108* .109 .111 .112 .136 .158*
 (*not available with siphon cover)

Furniture:
 48355.1/2

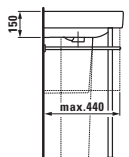
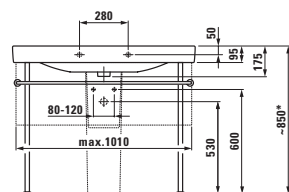
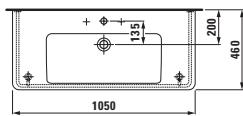

81496.5 ○/●/●●●
Double countertop washbasin
 Doppelwaschtisch, unterbaufähig
 Lavabo double à poser sur meuble
 Lavabo consolle doppio

88596.3
Towel frame
 Handtuchrahmen
 Tablier pour serviette
 Portasalviette

Options:
 .104 .107 .108* .109 .111 .112 .136
 .158* (*not available with siphon cover)

Furniture:
 48356.1/2

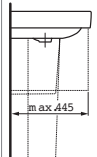
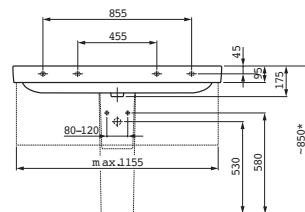
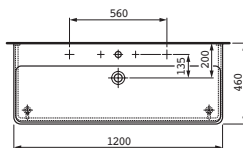

81496.6 ○/●/●●●
Double countertop washbasin
 Doppelwaschtisch, unterbaufähig
 Lavabo double à poser sur meuble
 Lavabo consolle doppio

88596.3
Towel frame
 Handtuchrahmen
 Tablier pour serviette
 Portasalviette

Options:
 .104 .107 .108* .109 .111 .112 .136
 .158* (*not available with siphon cover)

Furniture:
 48356.3/4

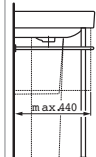
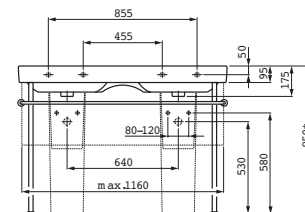
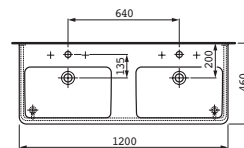

LAUFEN PRO S



81496.8 ○/●/●●●
Double countertop washbasin
 Doppelwaschtisch, unterbaufähig
 Lavabo double à poser sur meuble
 Lavabo consolle doppio

38596.2
Towel frame
 Handtuchrahmen
 Tablier pour serviette
 Portasalvietta

Options:
 .104 .108* .109 .111 .112 .136 .158*
 (*not available with siphon cover)

Furniture:
 48357.1/2

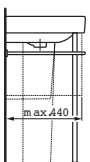
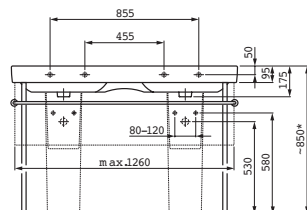
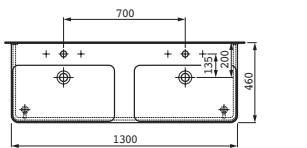

Compact countertop washbasin ○/●/●●●
 Waschtisch Compact, unterbaufähig
 Lavabo à poser sur meuble Compact
 Lavabo consolle Compact

	A	B
81895.8	550	510
81895.9	600	550

Washbasin, undersurface ground
 Aufsatz-Waschtisch, wandmontiert
 Lavabo, face inférieure meulée
 Lavabo, superficie inferiore levigata

	A
81795.8	550
81795.9	600

Options:
 .104 .108* .109 .142 .156*
 (*not available with siphon cover)

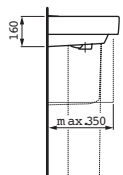
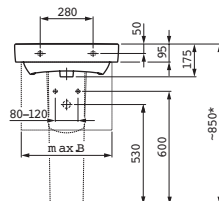
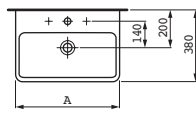

81896.3 ○/●/●●●
Drop-in washbasin
 Einbauwaschtisch von oben
 Lavabo à encastrer par-dessus
 Lavabo da incasso soprapiano

Options:
 .104 .108 .109 .111 .112 .136 .158

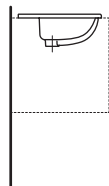
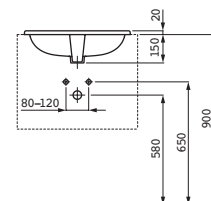
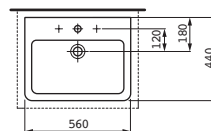

Washbasin bowl ○/●/●●●
 Aufsatz-Waschtisch
 Lavabo à poser
 Bacinella

	A
81295.2	550
81295.3	600

Options:
 .104 .108 .109 .142 .156

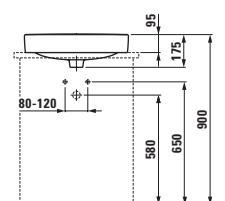
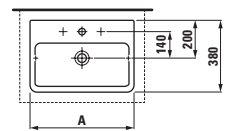



81695.2
Washbasin bowl, without tapbank
 Aufsatz-Waschtisch, ohne Armaturenbank
 Lavabo à poser, sans plage pour la robinetterie
 Bacinella, senza piano per rubinetteria

Options:
 .112

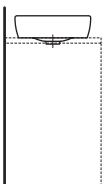
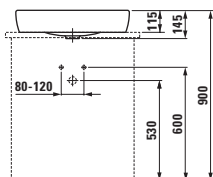
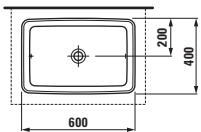

81196.6
Built-in washbasin, with tapbank, ground
 Einbauwaschtisch von unten, mit Armaturenbank, geschliffen
 Lavabo à encastrer par-dessous, avec plage pour la robinetterie, meulé
 Lavabo da incasso sottopiano, con piano per rubinetteria, levigato

Options:
 .104 .108 .109 .155

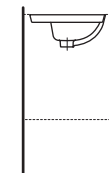
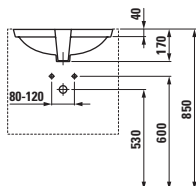
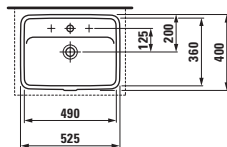

Built-in washbasin, without tap bank
 Einbauwaschtisch von unten, ohne Armaturenbank, geschliffen
 Lavabo à encastrer par-dessous, sans plage pour la robinetterie, meulé
 Lavabo da incasso sottopiano, senza piano per rubinetteria, levigato

	A	B	C	D
81196.0/.1*	525	490	400	360
81196.3/.8*	595	550	430	380
81196.5/.9*	645	600	450	400

* ground
 geschliffen
 meulée
 levigata

Options:
 .109 .155

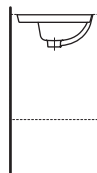
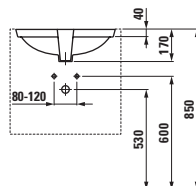
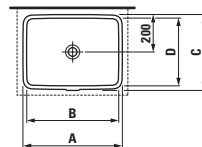

81996.4
Siphon cover, ceramic
 Siphonverkleidung, Keramik
 Cache siphon, céramique
 Coprisifone, ceramica

for/für/pour/per:
 81596.1

81996.2
Pedestal, ceramic
 Säule, Keramik
 Colonne, céramique
 Colonna, ceramica

for/für/pour/per:
 81096.2/.3/.4/.7
 81396.5/.6
 81496.5/.6/.8

81996.3
Siphon cover, ceramic
 Siphonverkleidung, Keramik
 Cache siphon, céramique
 Coprisifone, ceramica

for/für/pour/per:
 81096.2/.3/.4/.7
 81396.5/.6
 81496.5/.6/.8

81995.0
Pedestal, ceramic
 Säule, Keramik
 Colonne, céramique
 Colonna, ceramica

for/für/pour/per:
 81895.8/.9

81995.1
Siphon cover, ceramic
 Siphonverkleidung, Keramik
 Cache siphon, céramique
 Coprisifone, ceramica

for/für/pour/per:
 81895.8/.9

LAUFEN PRO S



6096.1
Washbasin with vanity unit, drawer and softclose
 Waschtisch mit Waschtischunterbau, Schublade und softclose
 Lavabo avec meuble sous lavabo, tiroir et softclose
 Lavabo con base sottolavabo, cassetto softclose

6096.2
Washbasin with interior drawer
 Waschtisch mit Innenschublade
 Lavabo avec tiroir intérieur
 Lavabo con cassetto interno



6196.1
with 2 drawers
 mit 2 Schubladen
 avec 2 tiroirs
 con 2 cassetti

NEW

Options: .104

Furniture colours: .423 .463 .475 .480

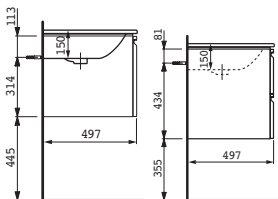
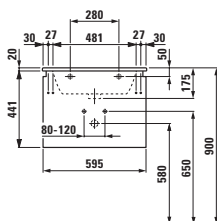
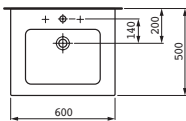

6096.3
Washbasin with vanity unit, drawer and softclose
 Waschtisch mit Waschtischunterbau, Schublade und softclose
 Lavabo avec meuble sous lavabo, tiroir et softclose
 Lavabo con base sottolavabo, cassetto e softclose

6096.4
Washbasin with interior drawer
 Waschtisch mit Innenschublade
 Lavabo avec tiroir intérieur
 Lavabo con cassetto interno



6196.3
with 2 drawers
 mit 2 Schubladen
 avec 2 tiroirs
 con 2 cassetti

NEW

Options: .104

Furniture colours: .423 .463 .475 .480

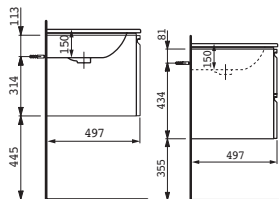
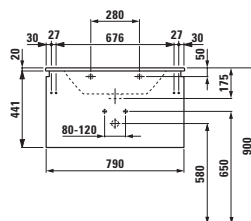
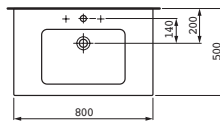

6096.5
Washbasin with vanity unit, drawer and softclose
 Waschtisch mit Waschtischunterbau, Schublade und softclose
 Lavabo avec meuble sous lavabo, tiroir et softclose
 Lavabo con base sottolavabo, cassetto e softclose

6096.6
Washbasin with interior drawer
 Waschtisch mit Innenschublade
 Lavabo avec tiroir intérieur
 Lavabo con cassetto interno



6196.5
with 2 drawers
 mit 2 Schubladen
 avec 2 tiroirs
 con 2 cassetti

NEW

Options: .104

Furniture colours: .423 .463 .475 .480

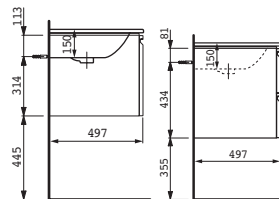
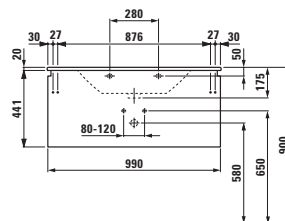
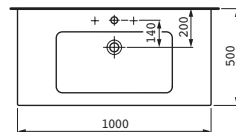

9095.2
Towel rail 400 mm, chromed metal
 Handtuchhalter 400 mm, Metall verchromt
 Porte-serviettes 400 mm, en métal chromé
 Portasciugamani 400 mm, in metallo cromato

Suitable for LAUFEN pro S
 Passend für LAUFEN pro S
 Pour LAUFEN pro S
 Adatto a LAUFEN pro S
 6096.1, 6096.2, 6096.3, 6096.4, 6096.5, 6096.6





Vanity unit, with 1 internal glass shelf and 1 door, with softclose mechanism

Waschtischunterbau, mit 1 Glasfachboden innen und 1 Türe, mit softclose
 Meuble sous lavabo, avec 1 étagère en verre intérieur et 1 porte, avec softclose
 Base sottolavabo, con 1 ripiano interno di vetro e 1 anta, con softclose

48300.1 Asymmetric left, with side storage right, for washbasin 81595.5

Asymmetrisch links, mit Seitenablage rechts, für Waschtisch 81595.5
 Asymétrique gauche, avec rack latéral, pour lavabo 81595.5
 Asimmetrica sinistra, con portaoggetti laterale, per lavabo 81595.5

48300.2 Asymmetric right, with side storage right, for washbasin 81595.4

Asymmetrisch rechts, mit Seitenablage rechts, für Waschtisch 81595.4
 Asymétrique droite, avec rack latéral, pour lavabo 81595.4
 Asimmetrica destra, con portaoggetti laterale, per lavabo 81595.4

Colours:
 .423 .463 .465 .475 .480 .999

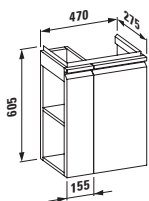
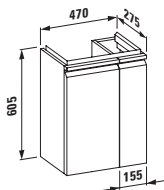

Vanity unit, with softclose mechanism, for washbasin 81596.1

Waschtischunterbau für Waschtisch, mit softclose, für Waschtisch 81596.1
 Meuble sous lavabo pour lavabo, avec softclose, pour lavabo 81596.1
 Base sottolavab, con softclose, per lavabo 81596.1

48330.1 With door left and 1 glass shelf
 Mit Tür links und 1 Glasfachboden
 Avec porte à gauche et 1 étagère en verre
 Con anta verso sinistra e 1 ripiano di vetro

48330.2 With door right and 1 glass shelf
 Mit Tür rechts und 1 Glasfachboden
 Avec porte à droite et 1 étagère en verre
 Con anta verso destra e 1 ripiano di vetro

Colours:
 .423 .463 .475 .480 .999

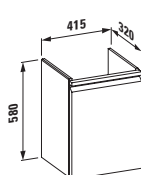

Vanity unit, with softclose mechanism, for washbasin 81895.8

Waschtischunterbau, mit softclose, für Waschtisch 81895.8
 Meuble sous lavabo, avec softclose, pour lavabo 81895.8
 Base sottolavabo, con softclose, per lavabo 81895.8

48302.1 With drawer
 Mit Schublade
 Avec tiroir
 Con cassetto

48302.2 With drawer and interior drawer
 Mit Schublade und Innenschublade
 Avec tiroir et tiroir intérieur
 Con cassetto e cassetto interno

Colours:
 .423 .463 .465 .475 .480 .999

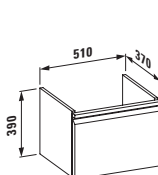

48310.0 Feet, optional
 Füße, optional
 Pieds, en option
 Piedini, opzionali

for/für/pour/per:
 48330.1/.2

48309.1 Feet, optional
 Füße, optional
 Pieds, en option
 Piedini, opzionali

for/für/pour/per:
 48300.1/.2

48310.2 Feet, optional
 Füße, optional
 Pieds, en option
 Piedini, opzionali

for/für/pour/per:
 86096.1/.2/.3/.4/.5/.6

48309.5 Feet, optional
 Füße, optional
 Pieds, en option
 Piedini, opzionali

for/für/pour/per:
 48302.1.2

LAUFEN PRO S



Vanity unit, with softclose mechanism, for washbasin 1096.2, 550 mm

Waschtischunterbau, mit softclose, für Waschtisch 1096.2, 550mm
Meuble sous lavabo, avec softclose, pour lavabo 1096.2, 550mm
Base sottolavabo, con softclose, per lavabo 1096.2, 550mm

48335.1
With drawer
Mit Schublade
Avec tiroir
Con cassetto

48335.2
With drawer and interior drawer
Mit Schublade und Innenschublade
Avec tiroir et tiroir intérieur
Con cassetto e cassetto interno

Colours:
.423 .463 .475 .480 .999

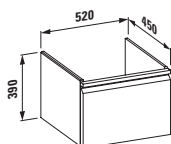

Vanity unit, with softclose mechanism, for washbasin 1895.9, 550/600mm

Waschtischunterbau, mit softclose, für Waschtisch 1895.9, 550/600mm
Meuble sous lavabo, avec softclose, pour lavabo 1895.9, 550/600mm
Base sottolavabo, con softclose, per lavabo 1895.9, 550/600mm

48303.1
With drawer
Mit Schublade
Avec tiroir
Con cassetto

48303.2
With drawer and interior drawer
Mit Schublade und Innenschublade
Avec tiroir et tiroir intérieur
Con cassetto e cassetto interno

Colours:
.423 .463 .475 .480 .999

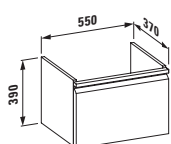

Vanity unit, with softclose mechanism, for washbasin 1096.3, 600mm

Waschtischunterbau, mit softclose, für Waschtisch 1096.3, 600mm
Meuble sous lavabo, avec softclose, pour lavabo 1096.3, 600mm
Base sottolavabo, con softclose, per lavabo 1096.3, 600mm

48337.1
With drawer
Mit Schublade
Avec tiroir
Con cassetto

48337.2
With drawer and interior drawer
Mit Schublade und Innenschublade
Avec tiroir et tiroir intérieur
Con cassetto e cassetto interno

Colours:
.423 .463 .475 .480 .999

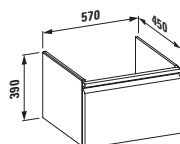

Vanity unit, with softclose mechanism, for washbasin 1096.4, 650mm

Waschtischunterbau, mit softclose, für Waschtisch 1096.4, 650mm
Meuble sous lavabo, avec softclose, pour lavabo 1096.4, 650mm
Base sottolavabo, con softclose, per lavabo 1096.4, 650mm

48342.1
With drawer
Mit Schublade
Avec tiroir
Con cassetto

48342.2
With drawer and interior drawer
Mit Schublade und Innenschublade
Avec tiroir et tiroir intérieur
Con cassetto e cassetto interno

Colours:
.423 .463 .475 .480 .999

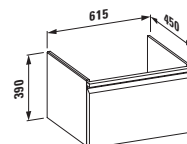



Vanity unit, with softclose mechanism, for washbasin 81096.7, 700mm

Waschtischunterbau, mit softclose, für Waschtisch 81096.7, 700mm
Meuble sous lavabo, avec softclose, pour lavabo 81096.7, 700mm
Base sottolavabo, con softclose, per lavabo 81096.7, 700mm

48345.1

With drawer

Mit Schublade
Avec tiroir
Con cassetto

48345.2

With drawer and interior drawer

Mit Schublade und Innenschublade
Avec tiroir et tiroir intérieur
Con cassetto e cassetto interno

Colours:

.423 .463 .475 .480 .999

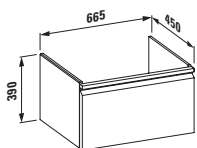

Vanity unit, with softclose mechanism, for washbasin 81396.5, 850mm

Waschtischunterbau, mit softclose, für Waschtisch 81396.5, 850mm
Meuble sous lavabo, avec softclose, pour lavabo 81396.5, 850mm
Base sottolavabo, con softclose, per lavabo 81396.5, 850mm

48350.1

With drawer

Mit Schublade
Avec tiroir
Con cassetto

48350.2

With drawer and interior drawer

Mit Schublade und Innenschublade
Avec tiroir et tiroir intérieur
Con cassetto e cassetto interno

Colours:

.423 .463 .475 .480 .999

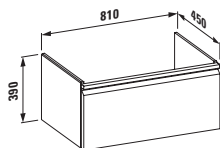

Vanity unit, with softclose mechanism, for washbasin 81396.6, 1050mm

Waschtischunterbau, mit softclose, für Waschtisch 81396.6, 1050mm
Meuble sous lavabo, avec softclose, pour lavabo 81396.6, 1050mm
Base sottolavabo, con softclose, per lavabo 81396.6, 1050mm

48355.1

With drawer

Mit Schublade
Avec tiroir
Con cassetto

48355.2

With drawer and interior drawer

Mit Schublade und Innenschublade
Avec tiroir et tiroir intérieur
Con cassetto e cassetto interno

Colours:

.423 .463 .475 .480 .999

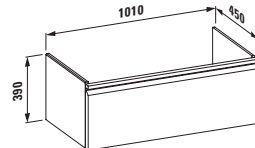

Vanity unit, with softclose mechanism, for washbasin 81496.5, 1200mm

Waschtischunterbau, mit softclose, für Waschtisch 81496.5, 1200mm
Meuble sous lavabo, avec softclose, pour lavabo 81496.5, 1200mm
Base sottolavabo, con softclose, per lavabo 81496.5, 1200mm

48356.1

With drawer

Mit Schublade
Avec tiroir
Con cassetto

48356.2

With drawer and interior drawer

Mit Schublade und Innenschublade
Avec tiroir et tiroir intérieur
Con cassetto e cassetto interno

Colours:

.423 .463 .475 .480 .999

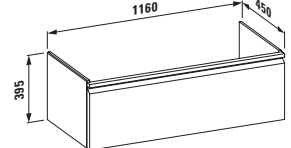

LAUFEN PRO S



Vanity unit, with softclose mechanism, for washbasin 81496.6, 1200mm

Waschtischunterbau, mit softclose, für Waschtisch 81496.6, 1200mm
 Meuble sous lavabo, avec softclose, pour lavabo 81496.6, 1200mm
 Base sottolavabo, con softclose, per lavabo 81496.6, 1200mm

48356.3

With drawer
 Mit Schublade
 Avec tiroir
 Con cassetto

48356.4

With drawer and interior drawer
 Mit Schublade und Innenschublade
 Avec tiroir et tiroir intérieur
 Con cassetto e cassetto interno

Colours:

.423 .463 .475 .480 .999

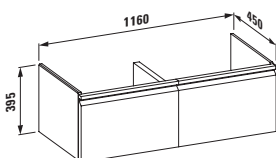

Vanity unit, with softclose mechanism, for washbasin 81496.8, 1300mm

Waschtischunterbau, mit softclose, für Waschtisch 81496.8, 1300mm
 Meuble sous lavabo, avec softclose, pour lavabo 81496.8, 1300mm
 Base sottolavabo, con softclose, per lavabo 81496.8, 1300mm

48357.1

With 2 drawers
 Mit 2 Schubladen
 Avec 2 tiroirs
 Con 2 cassetti

48357.2

With 2 drawers and interior drawer
 Mit 2 Schubladen und Innenschublade
 Avec 2 tiroirs et tiroir intérieur
 Con 2 cassetti e cassetto interno

Colours:

.423 .463 .475 .480 .999

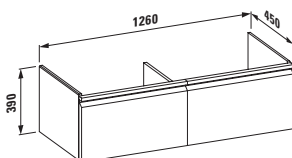

8310.1

Feet, optional

Füße, optional
 Pieds, en option
 Piedini, opzionali

for/für/pour/per:

48335.1/.2
 48337.1/.2
 48342.1/.2
 48345.1/.2
 48350.1/.2
 48355.1/.2
 48356.1/.2/.3/.4
 48357.1/.2

8309.5

feet, optional

Füße, optional
 Pieds, en option
 Piedini, opzionali

for/für/pour/per:

48303.1
 48303.2

LAUFEN PRO S



Medium cabinet, with 2 glass shelves, with softclose mechanism

Halbhochschrank, mit 2 Glasfachböden, mit softclose
Armoire mi-haute, avec 2 étagères en verre, avec softclose
Colonna media, con 2 ripiani di vetro, con softclose

48311.1 Door hinges left

Türanschlag links
Charnières de porte à gauche
Anta con apertura verso sinistra

48311.2 Door hinges right

Türanschlag rechts
Charnières de porte a droite
Anta con apertura verso destra

Colours:
.423 .463 .475 .480 .999

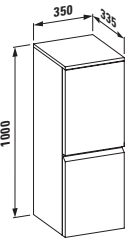

Tall cabinet, with 4 glass shelves, with softclose mechanism

Hochschrank, mit 4 Glasfachböden, mit softclose
Armoire, avec 4 étagères en verre, avec softclose
Colonna, con 4 ripiani di vetro, con softclose

48312.1 Door hinges left

Türanschlag links
Charnières de porte à gauche
Anta con apertura verso sinistra

48312.2 Door hinges right

Türanschlag rechts
Charnières de porte à droite
Anta con apertura verso destra

Colours:
.423 .463 .475 .480 .999

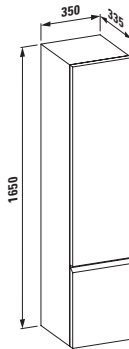

Small cabinet, with softclose mechanism

Kleiner Hochschrank, mit softclose
Petite armoire, avec softclose
Colonna piccola, con softclose

48311.3 Door hinges left

Türanschlag links
Charnières de porte à gauche
Anta con apertura verso sinistra

48311.4 Door hinges right

Türanschlag rechts
Charnières de porte à droite
Anta con apertura verso destra

Colours:
.423 .463 .475 .480 .999

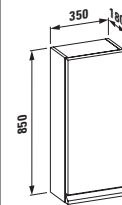

49095.0 Towel rail 270 mm, chromed metal

Handtuchhalter 270 mm, Metall verchromt
Porte-serviettes 270 mm, en métal chromé
Portasciugamani 270 mm, in metallo cromato

Suitable for LAUFEN pro S

Passend für LAUFEN pro S
Pour LAUFEN pro S
Adatto a LAUFEN pro S
48302.1, 48302.2, 48303.1, 48303.2



49095.2 Towel rail 400 mm, chromed metal

Handtuchhalter 400 mm, Metall verchromt
Porte-serviettes 400 mm, en métal chromé
Portasciugamani 400 mm, in metallo cromato



Suitable for LAUFEN pro S

Passend für LAUFEN pro S
Pour LAUFEN pro S
Adatto a LAUFEN pro S
48335.1, 48335.2, 48337.1, 48337.2, 48342.1, 48342.2, 48345.1, 48345.2, 48350.1, 48350.2, 48355.1, 48355.2, 48357.1, 48357.2, 48357.1, 48357.2

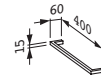



Colours:
.104 .105 .106



Colours towel rails / Farben Handtuchhalter / Couleurs porte-serviettes / Colori portasciugamani

 .104 Glossy anodised aluminium Aluminium glanzeloxiert Aluminium anodisé brillant Alluminio anodizzato brillante	 .105 Aluminium Aluminium Aluminium Alluminio	 .106 Dark brown aluminium Aluminium Dunkelbraun Aluminium brun foncé Alluminio bruno scuro
---	--	--

Colours of furniture pro S / Möbelfarben pro S / Couleurs des meubles pro S / Colori dei mobili pro S

 .463 White matt Weiß matt Blanc mat Bianco opaco	 .475 White glossy Weiß glänzend Blanc brillant Bianco brillante	 .423 Wenge Wenge Wengé Wengé	 .479 Bright oak Eiche hell Chêne clair Rovere chiaro	 .480 Graphite Graphit Graphite Grafite
---	---	--	--	--

.999 Multicolor

Please state colour number in the order text.

Bitte Farbnummer in der Bestellung angeben.

Prrière de préciser le numéro de la couleur dans le texte de la commande.

Si prega di specificare il numero di colore nell'ordine.

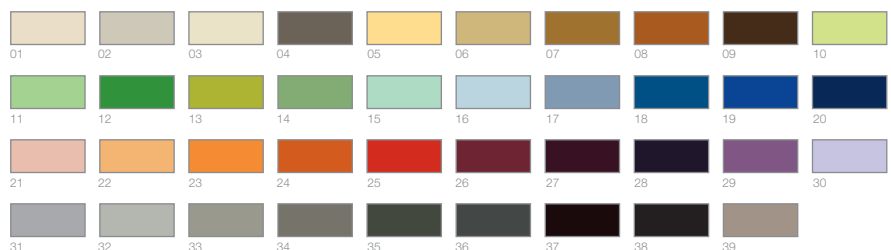

LAUFEN PRO B



81667.5

Small washbasin

Handwaschbecken
Lave-mains
Lavamani

○/●



81695.7

Small washbasin, tap hole left or right

Handwaschbecken, Hahnloch links oder rechts
Lave-mains, trou pour la robinetterie à gauche ou à droite
Lavamani, foro per rubinetteria a sinistra o a destra

○/●



Small washbasin

Handwaschbecken
Lave-mains
Lavamani

○/●

	A	B
81595.0	350	310
81595.1	400	320



Small washbasin

Handwaschbecken
Lave-mains
Lavamani

○/●

	A	B
81595.2	450	330
81595.3	500	360

81995.2

Siphon cover, ceramic
Siphonverkleidung, Keramik
Cache siphon, céramique
Coprifisone, ceramica

Options:
.106 .109

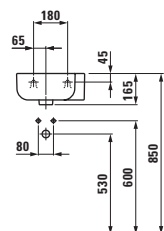
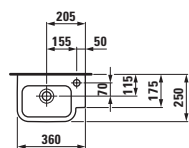

Options:
.105 .106 .109

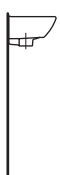
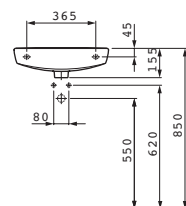
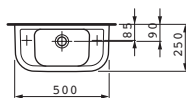

Options:
.104 .109

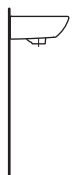
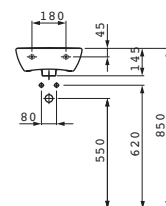
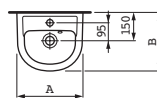

Options:
.104 .109 .142 .156

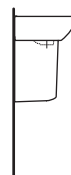
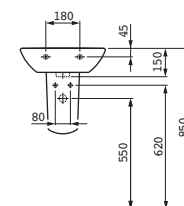
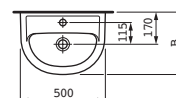

LAUFEN PRO B



Washbasin ○/●/●●●
 Waschtisch
 Lavabo
 Lavabo

	A	B	C	D	E	F
81095.1	550	440	130	200	160	185
81095.2	600	480	130	200	165	190
81095.3	650	500	130	200	175	195

Compact washbasin ○/●/●●●
 Waschtisch Compact
 Lavabo Compact
 Lavabo Compact

	A	B	C	D	E	F
81495.1	550	400	125	190	145	170
81495.2	600	420	125	190	145	170

81995.0
Pedestal, ceramic
 Säule, Keramik
 Colonne, céramique
 Colonna, ceramica

81995.1
Siphon cover, ceramic
 Siphonverkleidung, Keramik
 Cache siphon, céramique
 Coprisifone, ceramica

Options:
 .104 .108 .109 .142 .156

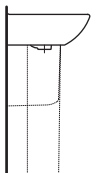
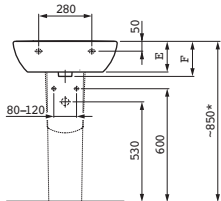
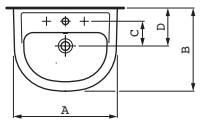

81695.8 ○/●
Corner small washbasin
 Eck-Handwaschbecken
 Lave-mains d'angle
 Lavamani d'angolo

Options:
 .104 .109

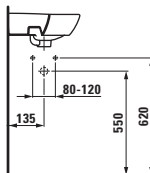
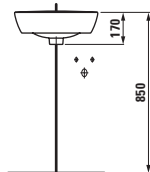
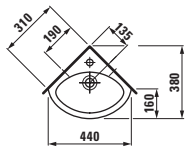

81695.6 ○/●
Corner small washbasin
 Eck-Handwaschbecken
 Lave-mains d'angle
 Lavamani d'angolo

Options:
 .104 .109

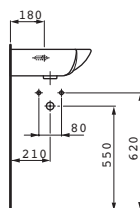
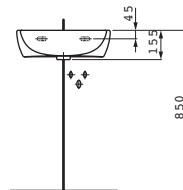
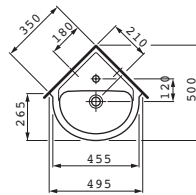

81295.1 ○/●
Semi-recessed washbasin
 Halbeinbauwaschtisch
 Lavabo à semi-encaster
 Lavabo semincasso

Options:
 .104 .109

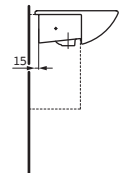
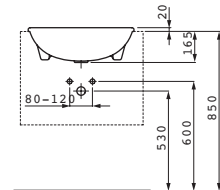
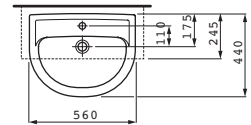

LAUFEN PRO B



81395.1 ○/●
Drop-in washbasin
 Einbauwaschtisch von oben
 Lavabo à encastrer par-dessus
 Lavabo da incasso soprapiano

Options:
 .104 .109

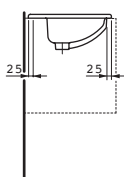
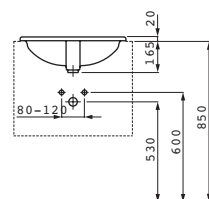
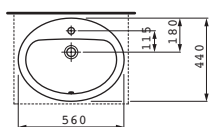

81296.2 ○
Washbasin bowl
 Aufsatz-Waschtisch
 Lavabo à poser
 Bacinella

Options:
 .109 .112 .142

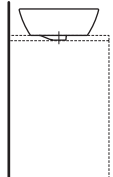
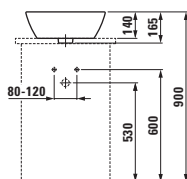
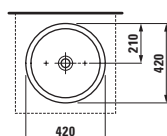

81296.4 ○
Washbasin bowl
 Aufsatz-Waschtisch
 Lavabo à poser
 Bacinella

Options:
 .109 .112 .142

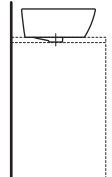
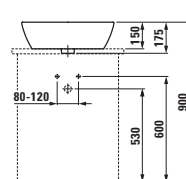
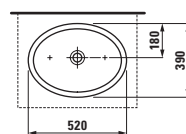

81896.1 ○
Built-in washbasin, without tapbank
 Einbauwaschtisch von unten, ohne Armaturenbank
 Lavabo à encastrer par-dessous, sans plage pour la robinetterie
 Lavabo da incasso sottopiano, senza piano per rubinetteria

81896.2 ○
Built-in washbasin, without tapbank, ground
 Einbauwaschtisch von unten, ohne Armaturenbank, geschliffen
 Lavabo à encastrer par-dessous, sans plage pour la robinetterie, meulé
 Lavabo da incasso sottopiano, senza piano per rubinetteria, levigato

Options:
 .109 .155

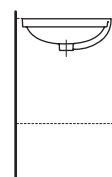
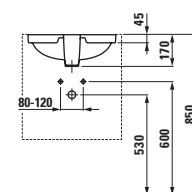
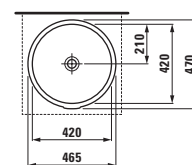

LAUFEN PRO B



48303.5
Vanity unit, with one drawer and one glass shelf, with blind and softclose mechanism, for washbasin 81095.1, 81095.2, 81095.3
 Waschtischunterbau, mit einer Schublade und einem Glasfachboden, mit Blende und softclose, passend zu Waschtischen 81095.1, 81095.2, 81095.3
 Meuble sous lavabo, avec un tiroir et une étagère en verre, avec habillage et softclose, pour lavabos 81095.1, 81095.2, 81095.3
 Base sottolavabo, con un cassetto e un ripiano di vetro, con collarino e softclose, per lavabi 81095.1, 81095.2, 81095.3

Colours:
 .423 .463 .465 .475

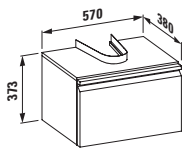

48311.1
Medium cabinet, with 2 glass shelves, with softclose mechanism
 Halbhochschrank, mit 2 Glasfachböden, mit softclose
 Armoire mi-haute, avec 2 étagères en verre, avec softclose
 Colonna media, con 2 ripiani di vetro, con softclose

48311.2
Door hinges left
 Türanschlag links
 Charnières de porte à gauche
 Anta con apertura verso sinistra

48311.2
Door hinges right
 Türanschlag rechts
 Charnières de porte à droite
 Anta con apertura verso destra

Colours:
 .423 .463 .465 .475 .999

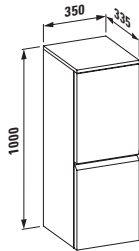

48312.1
Tall cabinet, with 4 glass shelves, with softclose mechanism
 Hochschrank, mit 4 Glasfachböden, mit softclose
 Armoire, avec 4 étagères en verre, avec softclose
 Colonna, con 4 ripiani di vetro, con softclose

48312.2
Door hinges left
 Türanschlag links
 Charnières de porte à gauche
 Anta con apertura verso sinistra

48312.2
Door hinges right
 Türanschlag rechts
 Charnières de porte à droite
 Anta con apertura verso destra

Colours:
 .423 .463 .465 .475 .999

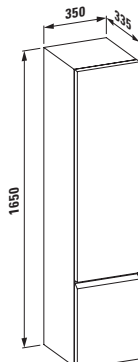

49095.1
Towel rail 400 mm, chromed metal
 Handtuchhalter 400 mm, Metall verchromt
 Porte-serviettes 400 mm, en métal chromé
 Portasciugamani 400 mm, in metallo cromato

Suitable for LAUFEN pro B
 Passend für LAUFEN pro B
 Pour LAUFEN pro B
 Adatto a LAUFEN pro B
48303.5

Colours:
 .104 .105 .106



Colours towel rails / Farben Handtuchhalter / Couleurs porte-serviettes / Colori portasciugamani



.104 Glossy anodised aluminium
 Aluminium glanzeloxiert
 Aluminium anodisé brillant
 Alluminio anodizzato brillante



.105 Aluminium
 Aluminium
 Aluminium
 Alluminio



.106 Dark brown aluminium
 Aluminium Dunkelbraun
 Aluminium brun foncé
 Alluminio bruno scuro

Colours of furniture pro B / Möbelfarben pro B / Couleurs des meubles pro B / Colori dei mobili pro B



.463 White matt
 Weiß matt
 Blanc mat
 Bianco opaco



.475 White glossy
 Weiß glänzend
 Blanc brillant
 Bianco brillante



.423 Wenge
 Wenge
 Wengé
 Wengé



.480 Graphite
 Graphit
 Graphite
 Grafite

.999 Multicolor

Please state colour number in the order text.

Bitte Farbnummer in der Bestellung angeben.

Prrière de préciser le numéro de la couleur dans le texte de la commande.

Si prega di specificare il numero di colore nell'ordine.

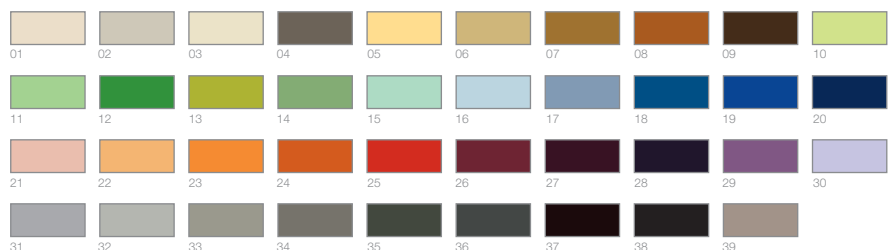

LAUFEN PRO A



81695.5

Small washbasin

Handwaschbecken
Lave-mains
Lavamani

○/●

Options:

.106 .109

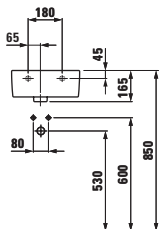
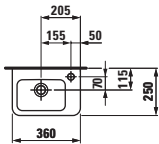

81195.1

Small countertop washbasin

Handwaschbecken, unterbaufähig
Lave-mains à poser sur meuble
Lavamani consolle

○/●

81995.2

Siphon cover, ceramic

Siphonverkleidung, Keramik
Cache-siphon, céramique
Coprififone in ceramica

81195.2

Washbasin, undersurface ground

Aufsatz-Waschtisch, wandmontiert
Lavabo, face inférieur meulée
Lavabo, superficie inferiore levigata

○/●

Options:

.104 .109 .142 .156

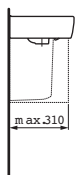
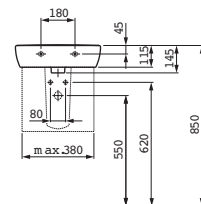
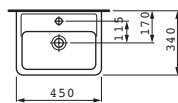

Washbasin

Waschtisch
Lavabo
Lavabo

○/●/●●●*

	A	B	C
81895.1	550	135	470
81895.2	600	135	520
81895.3	650	130	570

81995.0

Pedestal, ceramic

Säule, Keramik
Colonne, céramique
Colonna, ceramica

81995.1

Siphon cover, ceramic

Siphonverkleidung, Keramik
Cache siphon, céramique
Coprififone, ceramica

Washbasin, undersurface ground

Aufsatz-Waschtisch, wandmontiert
Lavabo, face inférieur meulée
Lavabo, superficie inferiore levigata

○/●/●●●

	A	B
81795.1	550	135
81795.2	600	135
81795.3	650	130

Options:

.104 .108* .109 .142 .156

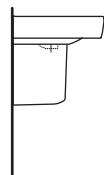
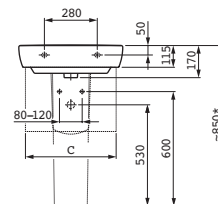
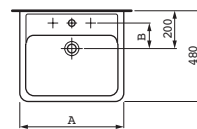

81395.6

Countertop washbasin

Waschtisch unterbaufähig
Lavabo à poser sur meuble
Lavabo consolle

○/●/●●●*

81995.0

Pedestal, ceramic

Säule, Keramik
Colonne, céramique
Colonna, ceramica

81995.1

Siphon cover, ceramic

Siphonverkleidung, Keramik
Cache siphon, céramique
Coprififone, ceramica

81295.6

Washbasin, undersurface ground

Aufsatz-Waschtisch, wandmontiert
Lavabo, face inférieur meulée
Lavabo, superficie inferiore levigata

○/●/●●●

89095.6.004.000.1

Towel frame

Handtuchrahmen
Tablier pour serviette
Portasalvietta

Options:

.104 .108* .109 .142 .156

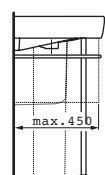
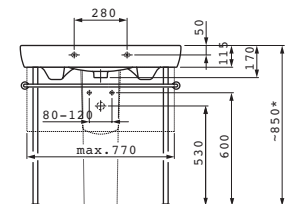
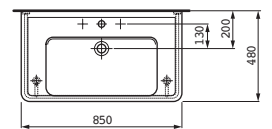



81395.8 ○/●/●●●*
Countertop washbasin
 Waschtisch unterbaufähig
 Lavabo à poser sur meuble
 Lavabo consolle

81995.0
Pedestal, ceramic
 Säule, Keramik
 Colonne, céramique
 Colonna, ceramica

81995.1
Siphon cover, ceramic
 Siphonverkleidung, Keramik
 Cache siphon, céramique
 Coprisifone, ceramica

81295.8 ○/●/●●●
Washbasin, undersurface ground
 Aufsatz-Waschtisch, wandmontiert
 Lavabo, face inférieur meulée
 Lavabo, superficie inferiore levigata

89095.8.004.000.1
Towel frame
 Handtuchrahmen
 Tablier pour serviette
 Portasalviette

Options:
 .104 .108* .109 .142 .156

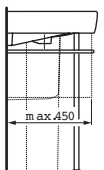
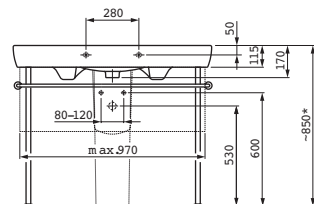
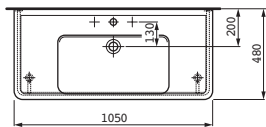

81496.7 ○/●/●●●*
Double countertop washbasin
 Doppelwaschtisch unterbaufähig
 Lavabo double à poser sur meuble
 Lavabo consolle, doppio bacino

81995.0
Pedestal, ceramic
 Säule, Keramik
 Colonne, céramique
 Colonna, ceramica

81995.1
Siphon cover, ceramic
 Siphonverkleidung, Keramik
 Cache siphon, céramique
 Coprisifone, ceramica

81396.7 ○/●/●●●
Double washbasin, undersurface ground
 Aufsatz-Doppelwaschtisch, wandmontiert
 Lavabo, face inférieur meulée
 Lavabo, superficie inferiore levigata

Options:
 .104 .108* .109 .142 .156

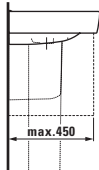
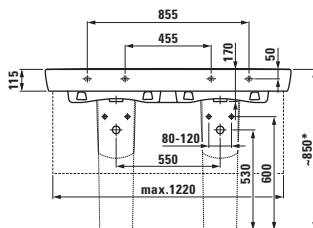
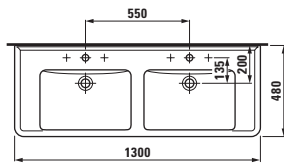

81296.1 ○/●/●●●
Semi-recessed washbasin
 Halbeinbauwaschtisch
 Lavabo à semi-encastrer
 Lavabo semincasso

Options:
 .104 .108 .109

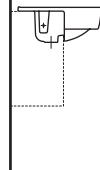
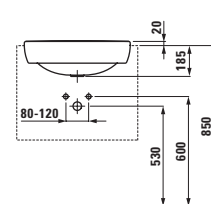
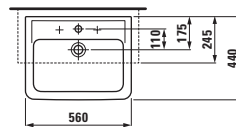

81396.1 ○/●/●●●
Drop-in washbasin
 Einbauwaschtisch von oben
 Lavabo à encastrer par-dessus
 Lavabo da incasso soprapiano

Options:
 .104 .108 .109 .155

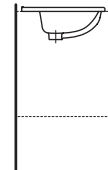
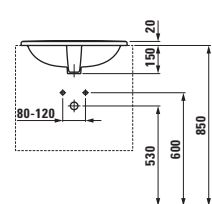
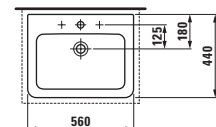

LAUFEN PRO A



Vanity unit, with 1 glass shelf, with softclose mechanism, for washbasin 81195.1

Waschtischunterbau, mit 1 Glasfachboden, mit softclose, passend zu Waschtisch 81195.1

Meuble sous lavabo, avec 1 étagère en verre, avec softclose, pour lavabo 81195.1

Base sottolavabo, con 1 ripiano di vetro, con softclose, per lavabo 81195.1

48301.1

Door hinge left

Türanschlag links

Charnières de porte à gauche
Anta con apertura verso sinistra

48301.2

Door hinge right

Türanschlag rechts

Charnières de porte à droite
Anta con apertura verso destra

48309.1

Feet, optional

Füße, optional
Pieds, en option
Piedini, opzionali

Colours:

.423 .463 .465 .475 .999

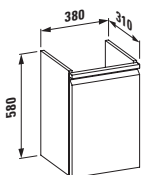

Vanity unit, with softclose mechanism, for washbasin 81895.1

Waschtischunterbau, mit softclose, passend zu Waschtisch 81895.1

Meuble sous lavabo, avec softclose, pour lavabo 81895.1

Base sottolavabo, con softclose, per lavabo 81895.1

48302.3

With drawer

Mit Schublade
Avec tiroir
Con cassetto

48302.4

With drawer and interior drawer

Mit Schublade und Innenschublade
Avec tiroir et tiroir intérieur
Con cassetto e cassetto interno

48309.2

Feet, optional

Füße, optional
Pieds, en option
Piedini, opzionali

Colours:

.423 .463 .465 .475 .999

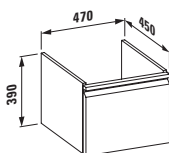

Vanity unit, with softclose mechanism, for washbasin 81895.2

Waschtischunterbau, mit softclose, passend zu Waschtisch 81895.2

Meuble sous lavabo, avec softclose, pour lavabo 81895.2

Base sottolavabo, con softclose, per lavabo 81895.2

48303.3

With drawer

Mit Schublade
Avec tiroir
Con cassetto

48303.4

With drawer and interior drawer

Mit Schublade und Innenschublade
Avec tiroir et tiroir intérieur
Con cassetto e cassetto interno

48309.2

Feet, optional

Füße, optional
Pieds, en option
Piedini, opzionali

Colours:

.423 .463 .465 .475 .999

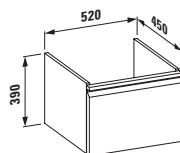

Vanity unit, with softclose mechanism, for washbasin 81895.3

Waschtischunterbau, mit softclose, passend zu Waschtisch 81895.3

Meuble sous lavabo, avec softclose, pour lavabo 81895.3

Base sottolavabo, con softclose, per lavabo 81895.3

48304.1

With drawer

Mit Schublade
Avec tiroir
Con cassetto

48304.2

With drawer and interior drawer

Mit Schublade und Innenschublade
Avec tiroir et tiroir intérieur
Con cassetto e cassetto interno

48309.2

Feet, optional

Füße, optional
Pieds, en option
Piedini, opzionali

Colours:

.423 .463 .465 .475 .999

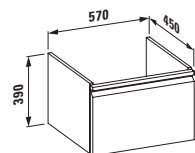



Vanity unit, with softclose mechanism, for washbasin 81395.6

Waschtischunterbau, mit softclose, passend zu Waschtisch 81395.6
Meuble sous lavabo, avec softclose, pour lavabo 81395.6
Base sottolavabo, con softclose, per lavabo 81395.6

**48306.1
With 1 drawer**

Mit 1 Schublade
Avec 1 tiroir
Con 1 cassetto

**48306.2
With 1 drawer and interior drawer**

Mit 1 Schublade und Innenschublade
Avec 1 tiroir et tiroir intérieur
Con 1 cassetto e cassetto interno

**48309.2
Feet, optional**

Füße, optional
Pieds, en option
Piedini, opzionali

Colours:
.423 .463 .475 .999

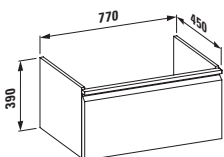

Vanity unit, with softclose mechanism, for washbasin 81395.8

Waschtischunterbau, mit softclose, passend zu Waschtisch 81395.8
Meuble sous lavabo, avec softclose, pour lavabo 81395.8
Base sottolavabo, con softclose, per lavabo 81395.8

**48307.1
With 1 drawer**

Mit 1 Schublade
Avec 1 tiroir
Con 1 cassetto

**48307.2
With 1 drawer and interior drawer**

Mit 1 Schublade und Innenschublade
Avec 1 tiroir et tiroir intérieur
Con 1 cassetto e cassetto interno

**48309.2
Feet, optional**

Füße, optional
Pieds, en option
Piedini, opzionali

Colours:
.423 .463 .475 .999

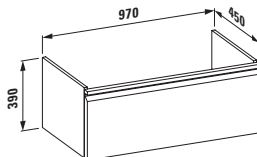

Vanity unit, with softclose mechanism, for washbasin 81496.7

Waschtischunterbau, mit softclose, passend zu Waschtisch 81496.7
Meuble sous lavabo, avec softclose, pour lavabo 81496.7
Base sottolavabo, con softclose, per lavabo 81496.7

**48308.1
With 2 drawers**

Mit 2 Schubladen
Avec 2 tiroirs
Con 2 cassetti

**48308.2
With 2 drawers and 2 interior drawers**

Mit 2 Schubladen und 2 Innenschubladen
Avec 2 tiroirs et 2 tiroir intérieurs
Con 2 cassetti e 2 cassetti interni

**48309.2
Feet, optional**

Füße, optional
Pieds, en option
Piedini, opzionali

Colours:
.423 .463 .475 .999

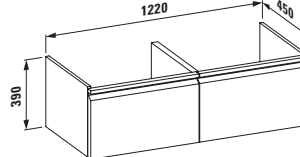

**49095.1
Towel rail, 320 mm, glossy anodised aluminium**

Handtuchhalter, 320 mm, Aluminium glanzeloxiert
Porte-serviettes, 320 mm, aluminium anodisé brillant
Portasciugamani, 320 mm, alluminio anodizzato brillante

Suitable for LAUFEN pro A

Passend für LAUFEN pro A
Pour LAUFEN pro A
Adatto a LAUFEN pro A
48302.3, 48302.4, 48303.3, 48303.4, 48304.1, 48304.2, 48306.1, 48306.2, 48307.1, 48307.2, 48308.1, 48308.2

Colours:
.104 .105 .106



LAUFEN PRO A



Medium cabinet, with 2 glass shelves, with softclose mechanism

Halbhochschrank, mit 2 Glasfachböden, mit softclose
Armoire mi-haute, avec 2 étagères en verre, avec softclose
Colonna media, con 2 ripiani di vetro, con softclose

48311.1

Door hinges left

Türanschlag links
Charnières de porte à gauche
Anta con apertura verso sinistra

48311.2

Door hinges right

Türanschlag rechts
Charnières de porte à droite
Anta con apertura verso destra

Colours:

.423 .463 .475 .999

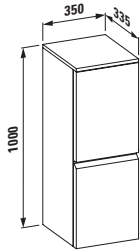

Tall cabinet, with 4 glass shelves, with softclose mechanism

Hochschrank, mit 4 Glasfachböden, mit softclose
Armoire, avec 4 étagères en verre, avec softclose
Colonna, con 4 ripiani di vetro, con softclose

48312.1

Door hinges left

Türanschlag links
Charnières de porte à gauche
Anta con apertura verso sinistra

48312.2

Door hinges right

Türanschlag rechts
Charnières de porte à droite
Anta con apertura verso destra

Colours:

.423 .463 .475 .999

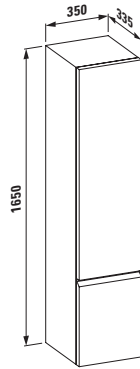

Small cabinet, with softclose mechanism

Kleiner Hochschrank, mit softclose
Petite armoire, avec softclose
Colonna piccola, con softclose

48311.3

Door hinges left

Türanschlag links
Charnières de porte à gauche
Anta con apertura verso sinistra

48311.4

Door hinges right

Türanschlag rechts
Charnières de porte à droite
Anta con apertura verso destra

Colours:

.423 .463 .475 .999

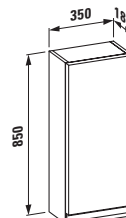

49095.2

Towel rail 400 mm, chromed metal

Handtuchhalter 400 mm, Metall verchromt
Porte-serviettes 400 mm, en métal chromé
Portasciugamani 400 mm, in metallo cromato

Suitable for LAUFEN pro A

Passend für LAUFEN pro A
Pour LAUFEN pro A
Adatto a LAUFEN pro A
48302.3, 48302.4, 48303.3, 48303.4, 48304.1, 48304.2, 48306.1, 48306.2, 48307.1, 48307.2, 48308.1, 48308.2

Colours:

.104 .105 .106



Colours towel rails / Farben Handtuchhalter / Couleurs porte-serviettes / Colori portasciugamani



.104 Glossy anodised aluminium

Aluminium glanzeloxiert
Aluminium anodisé brillant
Alluminio anodizzato brillante



.105 Aluminium

Aluminium
Aluminium
Alluminio



.106 Dark brown aluminium

Aluminium Dunkelbraun
Aluminium brun foncé
Alluminio bruno scuro

Colours of furniture pro A / Möbelfarben pro A / Couleurs des meubles pro A / Colori dei mobili pro A



.463 White matt

Weiß matt
Blanc mat
Bianco opaco



.475 White glossy

Weiß glänzend
Blanc brillant
Bianco brillante



.423 Wenge

Wenge
Wengé
Wengé



.480 Graphite

Graphit
Graphite
Grafite

.999 Multicolor

Please state colour number in the order text.

Bitte Farbnummer in der Bestellung angeben.

Prrière de préciser le numéro de la couleur dans le texte de la commande.

Si prega di specificare il numero di colore nell'ordine.

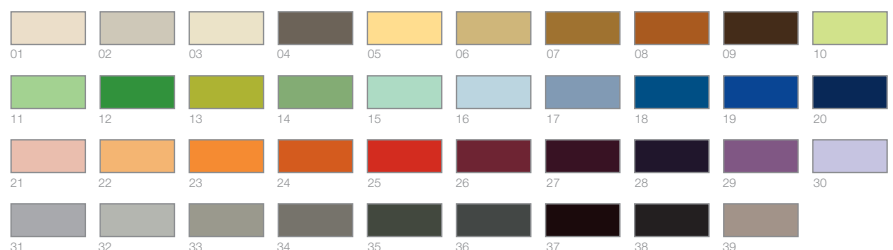



82096.1
Wall-hung WC, washdown
 Wand-WC, Tiefspüler
 WC suspendu, à chasse directe
 Vaso sospeso, a cacciata

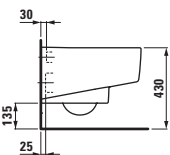
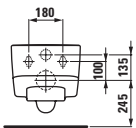
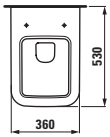

82096.2
Wall-hung WC rimless, wash-down
 Wand-WC spülrandlos, Tiefspüler
 WC suspendu, rimless, à chasse directe
 Vaso sospeso, rimless, a cacciata

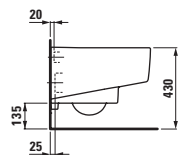
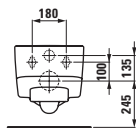
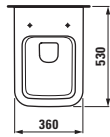

83096.1
Wall-hung bidet
 Wandbidet
 Bidet suspendu
 Bidet sospeso

Options:
 .302

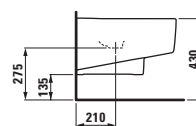
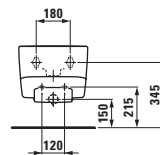
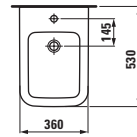

89196.0
Seat and cover, removable
 Sitz mit Deckel, abnehmbar
 Siège et couvercle, amovible
 Sedile con coperchio, estraibile

89196.1
Seat and cover, removable, with lowering system
 Sitz mit Deckel, abnehmbar, mit Absenkautomatik
 Siège et abattant, amovible, avec système d'abaissement
 Sedile con coperchio, estraibile, con sistema a caduta rallentata



ε2095.6

Wall-hung WC, washdown

Wand-WC, Tiefspüler
WC suspendu, à chasse directe
Vaso sospeso, a cacciata

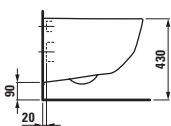
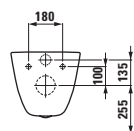
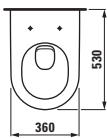

ε2095.9

Wall-hung WC, washout

Wand-WC, Flachspüler
WC suspendu, à fond plat
Vaso sospeso, a fondo piatto

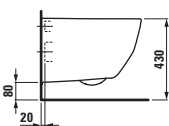
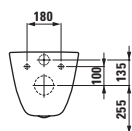
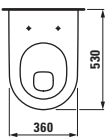

ε2096.6

Wall-hung WC rimless, washdown

Wand-WC spülrandlos, Tiefspüler
WC suspendu rimless, à chasse directe
Vaso sospeso rimless, a cacciata

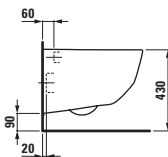
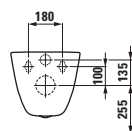

ε2096.4

Wall-hung WC rimless, washdown, with niches

Wand-WC spülrandlos, Tiefspüler, mit Nischen
WC suspendu rimless, à chasse directe, avec niches
Vaso sospeso rimless, a cacciata, con nicchia

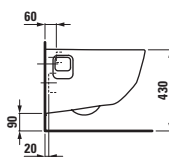
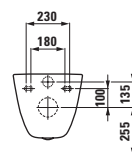



82096.5
Compact wall-hung WC rimless, washdown

Wand-WC Compact spülrandlos, Tiefspüler
WC suspendu Compact rimless, à chasse directe
Vaso sospeso Compact rimless, a cacciata

4.5L 3L

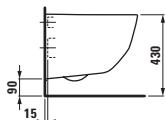
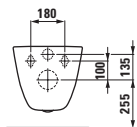
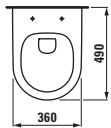

83095.2.302 ●
Wall-hung bidet, 1 tap hole in centre, without lateral holes for water inlet

Wand-Bidet, 1 Hahnloch mittig, ohne seitliche Löcher für Wasseranschluss
Bidet suspendu, avec 1 trou pour la robinetterie au milieu, sans trous latéraux pour le raccordement de l'eau
Bidet sospeso, 1 foro centrale per la rubinetteria, senza fori laterali per l'alimentazione dell'acqua

83095.2.304
Wall-hung bidet, 1 tap hole in centre, with lateral holes for water inlet

Wand-Bidet, 1 Hahnloch mittig, mit seitlichen Löchern für Wasseranschluss
Bidet suspendu, avec 1 trou pour la robinetterie au milieu, avec trous latéraux pour le raccordement de l'eau
Bidet sospeso, con 1 foro centrale per la rubinetteria, con fori laterali per l'alimentazione dell'acqua

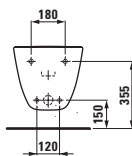
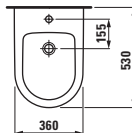

82295.6
Floorstanding WC, washdown, Vario outlet, back-to-wall, rimless

Stand-WC, Tiefspüler, Abgang Vario, wandbündig, spülrandlos
WC au sol, à chasse directe, sortie Vario, dos au mur
Vaso a pavimento, a cacciata, scarico Vario, a filo muro

4.5L 3L

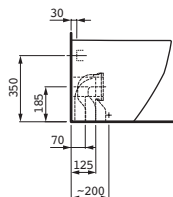
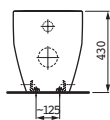
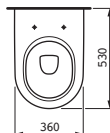

82295.2
Floorstanding WC, washdown, Vario outlet, back-to-wall

Stand-WC, Tiefspüler, Abgang Vario, wandbündig
WC au sol, à chasse directe, sortie Vario, dos au mur
Vaso a pavimento, a cacciata, scarico Vario, a filo muro

4.5L 3L

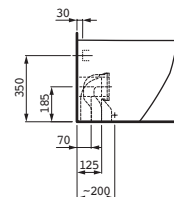
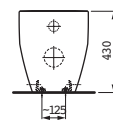
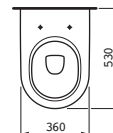

LAUFEN PRO



2595.1

Floorstanding WC combination rimless, washdown, outlet Vario
Stand-WC-Kombination spülrandlos, Tiefspüler, Abgang Vario
Installation de WC au sol rimless, à chasse directe, évacuation Vario
Vaso monoblocco a pavimento rimless, a cacciata, scarico Vario

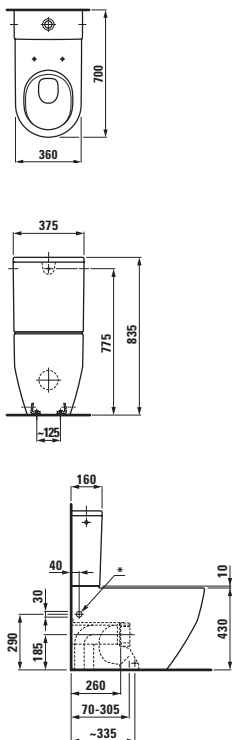

2595.2

Floorstanding WC combination, washdown, outlet Vario, back-to-wall
Stand-WC-Kombination, Tiefspüler, Abgang Vario, wandbündig
Installation de WC au sol, à chasse directe, évacuation Vario, dos au mur
Vaso monoblocco a pavimento, a cacciata, scarico Vario, a filo muro

2595.2.231

Floorstanding WC combination, washdown, outlet Vario, back-to-wall, with lateral holes for water inlet
Stand-WC-Kombination, Tiefspüler, Abgang Vario, wandbündig, mit seitlichen Löchern für Wasseranschluss
Installation de WC au sol, à chasse directe, évacuation Vario, dos au mur, avec trous latéraux pour le raccordement de l'eau
Vaso monoblocco a pavimento, a cacciata, scarico Vario, a filo muro, senza fori laterali per l'alimentazione dell'acqua

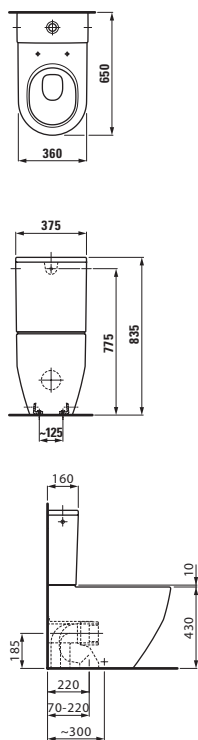

Only for WC

Nur für WC
Seulement pour WC
Soltanto per vaso
2995.1 *
2995.2 **

2995.1 * / **
Cistern, Dual Flush, water connection at back
Spülkasten, Dual Flush, Wasseranschluss hinten
Réservoir, Dual Flush, raccordement de l'eau à l'arrière
Cassetta di risciacquo, Dual Flush, alimentazione dell'acqua posteriore

2995.2 * / **
Cistern, Dual Flush, water connection on one side (left or right)
Spülkasten, Dual Flush, Wasseranschluss seitlich (links oder rechts)
Réservoir, Dual Flush, raccordement de l'eau latéral (gauche ou droite)
Cassetta di risciacquo, Dual Flush, alimentazione dell'acqua laterale (a sinistra o a destra)

2995.3 * / **
Cistern, Dual Flush, water connection bottom left
Spülkasten, Dual Flush, Wasseranschluss unten links
Réservoir, Dual Flush, raccordement de l'eau inférieure gauche
Cassetta di risciacquo, Dual Flush, alimentazione dell'acqua dal basso a sinistra

2995.5 **
Cistern, Dual Flush, water connection bottom right
Spülkasten, Dual Flush, Wasseranschluss unten rechts
Réservoir, Dual Flush, raccordement de l'eau inférieure droite
Cassetta di risciacquo, Dual Flush, alimentazione dell'acqua dal basso a destra



2295.1
Floorstanding WC, washdown, Vario outlet, back-to-wall, rimless
Stand-WC, Tiefspüler, Abgang Vario, wandbündig, spülrandlos
WC au sol, à chasse directe, sortie Vario, dos au mur
Vaso a pavimento, a cacciata, scarico Vario, a filo muro

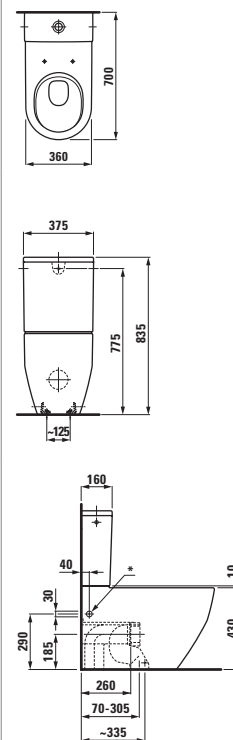



Floorstanding cistern, Dual Flush

Stand-Spülkasten, Dual-Flush
Réservoir au sol, Dual Flush
Cassetta di risciacquo a pavimento, Dual Flush

§2866.0

Water connection left or right at the top of the cistern

Wasseranschluss links oder rechts oben am Spülkasten
Raccordement de l'eau à gauche ou à droite sur le haut du réservoir
Alimentazione dell'acqua a destra o a sinistra sulla parte superiore della cassetta di risciacquo

§2866.1

Water connection back left at the top of the cistern

Wasseranschluss hinten links oben am Spülkasten
Raccordement de l'eau à l'arrière à gauche, sur le haut du réservoir
Alimentazione dell'acqua posteriore sinistra sulla parte superiore della cassetta di risciacquo

§2866.3

Water connection on the left side at the bottom of the cistern

Wasseranschluss auf der linken Seite unten am Spülkasten
Raccordement de l'eau à gauche sur le bas du réservoir
Alimentazione dell'acqua a sinistra sulla parte inferiore della cassetta di risciacquo

§2866.4

Water connection on the right side at the bottom of the cistern

Wasseranschluss auf der rechten Seite unten am Spülkasten
Raccordement de l'eau à droite sur le bas du réservoir
Alimentazione dell'acqua a destra sulla parte inferiore della cassetta di risciacquo

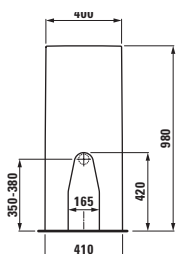

§3295.2.302



Floorstanding bidet, with 1 tap hole in centre, without lateral holes for water inlet

Standbidet, 1 Hahnloch mittig, ohne seitliche Löcher für Wasseranschluss
Bidet au sol, avec 1 trou pour la robinetterie au milieu, sans trous latéraux pour raccordement de l'eau
Bidet a pavimento, con 1 foro centrale per la rubinetteria, senza fori laterali per l'alimentazione dell'acqua

§3295.2.308

Floorstanding bidet, with 3 tap holes in centre, without lateral holes for water inlet

Standbidet, mit 3 Hahnlöchern, ohne seitliche Löcher für Wasseranschluss
Bidet au sol, avec 3 trous pour la robinetterie, sans trous latéraux pour raccordement de l'eau
Bidet a pavimento, con 3 fori centrale per la rubinetteria, senza fori laterali per l'alimentazione dell'acqua

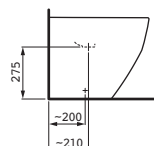
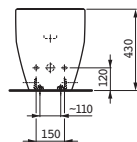
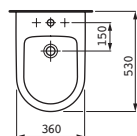

WC seats and covers for WCs

WC-Sitze für WCs
Sièges et abattants pour WCs
Sedile per vasi
§2095.6, §2096.4, §2096.5, §2096.6, §2295.2, §2595.2



§9695.0

WC seat and cover LAUFEN pro, removable

WC-Sitz mit Deckel LAUFEN pro, abnehmbar
Siège et abattant LAUFEN pro, amovibles
Sedile con coperchio LAUFEN pro, estraibile

§9695.1

WC seat and cover LAUFEN pro, removable, with lowering system

WC-Sitz mit Deckel LAUFEN pro, abnehmbar, mit Absenkautomatik
Siège et abattant LAUFEN pro, amovibles, avec système d'abaissement
Sedile con coperchio LAUFEN pro, estraibile, con sistema a caduta rallentata



§9896.5

WC seat and cover LAUFEN pro slim, removable

WC-Sitz mit Deckel LAUFEN pro slim, abnehmbar
Siège et abattant LAUFEN pro slim, amovibles
Sedile con coperchio LAUFEN pro slim, estraibile

§9896.6

WC seat and cover LAUFEN pro slim, removable, with lowering system

WC-Sitz mit Deckel LAUFEN pro slim, abnehmbar, mit Absenkautomatik
Siège et abattant LAUFEN pro slim, amovibles, avec système d'abaissement
Sedile con coperchio LAUFEN pro slim, estraibile, con sistema a caduta rallentata



§9395.5

WC seat and cover Universal, removable

WC-Sitz mit Deckel Universal, abnehmbar
Siège et abattant Universal, amovibles
Sedile con coperchio Universal, estraibile

§9395.6

WC seat and cover Universal, removable, with lowering system

WC-Sitz mit Deckel Universal, abnehmbar, mit Absenkautomatik
Siège et abattant Universal, amovibles, avec système d'abaissement
Sedile con coperchio Universal, estraibile, con sistema a caduta rallentata



2096.0

**Wall-hung WC, washdown
(180 mm distance between
mounting holes), rimless**

Wand-WC, Tiefspüler (180 mm
Abstand zwischen Befestigungs-
löchern). spülrandlos

WC suspendu, à chasse directe
(espacement de boulon de
scellement 180 mm)

Vaso sospeso, a cacciata (180 mm
di distanza tra i fori di fissaggio)

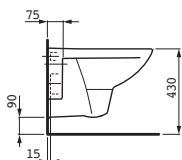
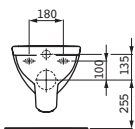
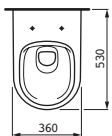

2095.0

**Wall-hung WC, washdown
(180 mm distance between
mounting holes)**

Wand-WC, Tiefspüler (180 mm
Abstand zwischen Befestigungs-
löchern)

WC suspendu, à chasse directe
(espacement de boulon de
scellement 180 mm)

Vaso sospeso, a cacciata (180 mm
di distanza tra i fori di fissaggio)

2095.5

**Wall-hung WC, washdown
(230 mm distance between
mounting holes)**

Wand-WC, Tiefspüler (230 mm
Abstand zwischen Befestigungs-
löchern)

WC suspendu, à chasse directe
(espacement de boulon de
scellement 230 mm)

Vaso sospeso, a cacciata (230 mm
di distanza tra i fori di fissaggio)

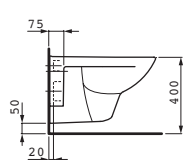
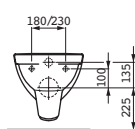

2095.1

Wall-hung WC, washout

Wand-WC, Flachspüler

WC suspendu, à fond plat

Vaso sospeso, a fondo piatto

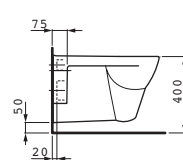
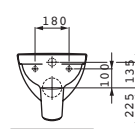
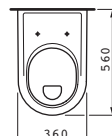

3095.1.302

**Wall-hung bidet, 1 tap hole in
centre, without lateral holes for
water inlet**

Wand-Bidet, 1 Hahnloch mittig, ohne
seitliche Löcher für Wasseranschluss
Bidet suspendu, avec 1 trou pour la
robinetterie au milieu, sans trous laté-
raux pour le raccordement de l'eau
Bidet sospeso, con 1 foro centrale
per la rubinetteria, senza fori laterali
per l'alimentazione dell'acqua

3095.1.304

**Wall-hung bidet, with 1 tap hole
in centre, with lateral holes for
water inlet**

Wand-Bidet, 1 Hahnloch mittig,
mit seitlichen Löchern für Wasser-
anschluss
Bidet suspendu, avec 1 trou pour la
robinetterie au milieu, avec trous laté-
raux pour le raccordement de l'eau
Bidet sospeso, con 1 foro centrale
per la rubinetteria, con fori laterali
per l'alimentazione dell'acqua

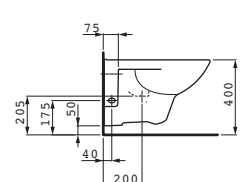
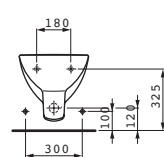
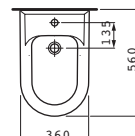



82095.2
Wall-hung WC Compact, washdown, 490 mm projection
 Wand-WC Compact, Tiefspüler, Ausladung 490 mm
 WC suspendu Compact, à chasse directe, saillie 490 mm
 Vaso sospeso Compact, a cacciata, profondità 490 mm

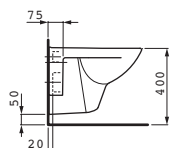
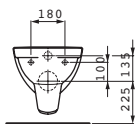
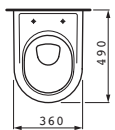

82495.6
Floorstanding WC combination, washdown, horizontal outlet
 Stand-WC-Kombination, Tiefspüler, Abgang waagrecht
 Installation de WC au sol, à chasse directe, sortie horizontale
 Vaso monoblocco a pavimento, a cacciata, scarico a parete

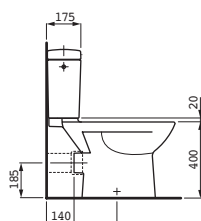
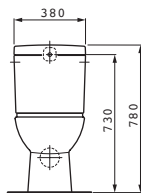
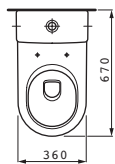

82495.7
Floorstanding WC combination, washdown, vertical outlet
 Stand-WC-Kombination, Tiefspüler, Abgang senkrecht
 Installation de WC au sol, à chasse directe, sortie verticale
 Vaso monoblocco a pavimento, a cacciata, scarico a pavimento

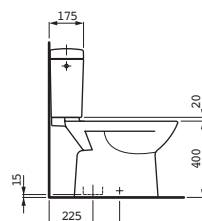
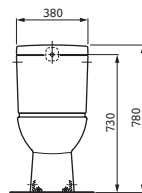
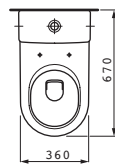

82495.8
Floorstanding WC combination, washdown, outlet Vario
 Stand-WC-Kombination, Tiefspüler, Abgang Vario
 Installation de WC au sol, à chasse directe, évacuation Vario
 Vaso monoblocco a pavimento, a cacciata, scarico Vario



82495.8.231
Floorstanding WC combination, washdown, outlet Vario, with lateral holes for water inlet
 Stand-WC-Kombination, Tiefspüler, Abgang Vario, mit seitlichen Löchern für Wasseranschluss
 Installation de WC au sol, à chasse directe, évacuation Vario, avec trous latéraux pour le raccordement de l'eau
 Vaso monoblocco a pavimento, a cacciata, scarico Vario, con fori laterali per l'alimentazione dell'acqua

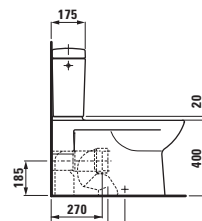
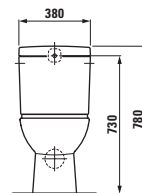
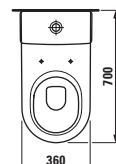



82495.9

Floorstanding WC combination, washout, outlet Vario

Stand-WC-Kombination, Flachspüler, Abgang Vario

Installation de WC au sol, à fond plat, évacuation Vario

Vaso monoblocco a pavimento, a fondo piatto, scarico Vario

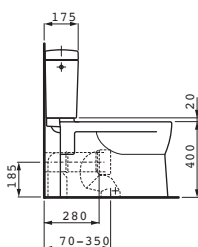
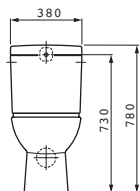
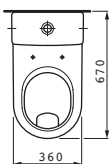

82495.5

Floorstanding WC combination, washdown, outlet Vario

Stand-WC-Kombination, Tiefspüler, Abgang Vario

Installation de WC au sol, à chasse directe, évacuation Vario

Vaso monoblocco a pavimento, a cacciata, scarico Vario

82495.5²³¹

Floorstanding WC combination, washdown, outlet Vario, with lateral holes for water inlet

Stand-WC-Kombination, Tiefspüler, Abgang Vario, mit seitlichen Löchern für Wasseranschluss

Installation de WC au sol, à chasse directe, évacuation Vario, avec trous latéraux pour le raccordement de l'eau

Vaso monoblocco a pavimento, a cacciata, scarico Vario, con fori laterali per l'alimentazione dell'acqua

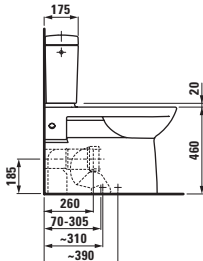
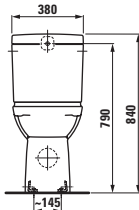
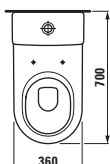

82295.1

Floorstanding WC, washdown, horizontal/vertical outlet, Vario

Stand-WC, Tiefspüler, Abgang waagrecht/senkrecht, Vario

WC au sol, à chasse directe, sortie horizontale/verticale, Vario

Vaso a pavimento, a cacciata, scarico a parete/a pavimento, Vario

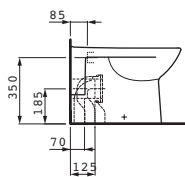
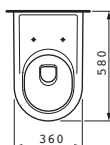

Cistern for WCs

Spülkasten für WCs

Réservoir pour WCs

Cassetta di risciacquo per vasi

82495.5, 82495.6, 82495.7, 82495.8, 82495.9

82695.1

Cistern, Dual Flush, water connection at back

Spülkasten, Dual Flush, Wasseranschluss hinten

Réservoir, Dual Flush, raccordement de l'eau à l'arrière

Cassetta di risciacquo, Dual Flush, alimentazione dell'acqua posteriore

82695.2

Cistern, Dual Flush, water connection on one side (left or right)

Spülkasten, Dual Flush, Wasseranschluss seitlich (links oder rechts)

Réservoir, Dual Flush, raccordement de l'eau latéral (gauche ou droite)

Cassetta di risciacquo, Dual Flush, alimentazione dell'acqua laterale (a sinistra o a destra)

82695.3

Cistern, Dual Flush, water connection bottom left

Spülkasten, Dual Flush, Wasseranschluss unten links

Réservoir, Dual Flush, raccordement de l'eau inférieure gauche

Cassetta di risciacquo, Dual Flush, alimentazione dell'acqua dal basso a sinistra

82695.5

Cistern, Dual Flush, water connection bottom right

Spülkasten, Dual Flush, Wasseranschluss unten rechts

Réservoir, Dual Flush, raccordement de l'eau inférieure droite

Cassetta di risciacquo, Dual Flush, alimentazione dell'acqua dal basso a destra



83295.1.304 ●

Floorstanding bidet, 1 tap hole in centre, without lateral holes for water inlet

Standbidet, 1 Hahnloch mittig, ohne seitliche Löcher für Wasseranschluss
 Bidet au sol, 1 trou pour la robinetterie au milieu, sans trous latéraux pour le raccordement d'eau
 Bidet a pavimento, 1 foro centrale per la rubinetteria, senza fori laterali per l'alimentazione dell'acqua

83295.1.308 ●●●

Floorstanding bidet, with 3 tap holes in centre, without lateral holes for water inlet

Standbidet, mit 3 Hahnlöchern, ohne seitliche Löcher für Wasseranschluss
 Bidet au sol, 3 trous pour la robinetterie, sans trous latéraux pour le raccordement d'eau
 Bidet a pavimento, 3 fori per la rubinetteria, senza fori laterali per l'alimentazione dell'acqua

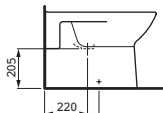
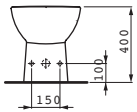
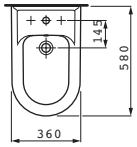

82395.3

One piece WC, including seat and cover, removable, with lowering system

One piece WC, Sitz und Deckel inklusive, abnehmbar, mit Absenksystem
 One piece WC, Siège et abattant inclus, amovibles, avec système d'abaissement
 One piece WC, Sedile con coperchio compreso, estraibile, con sistema a caduta rallentata

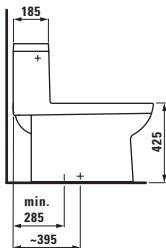
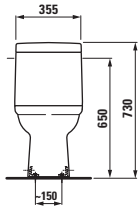
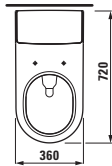

82195.6

Floorstanding WC, washdown, horizontal outlet

Stand-WC, Tiefspüler, Abgang waagrecht
 WC au sol, à chasse directe, sortie horizontale
 Vaso a pavimento, a cacciata, scarico a parete

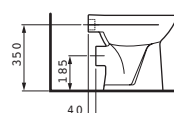
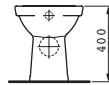
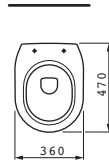

82195.8

Floorstanding WC, washout, horizontal outlet

Stand-WC, Flachspüler, Abgang waagrecht
 WC au sol, à fond plat, sortie horizontale
 Vaso a pavimento, a fondo piatto, scarico a parete

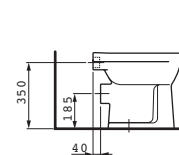
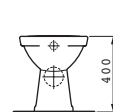
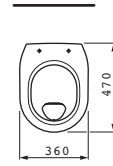



82595.5
Floorstanding WC, washdown, horizontal outlet

Stand-WC, Tiefspüler,
 Abgang waagrecht
 WC au sol, à chasse directe,
 sortie horizontale
 Vaso a pavimento, a cacciata,
 scarico a parete

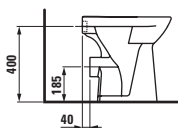
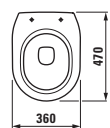

82595.7
Floorstanding WC, washout, vertical outlet

Stand-WC, Flachspüler,
 Abgang senkrecht
 WC au sol, à fond plat,
 sortie verticale
 Vaso a pavimento, a fondo piatto,
 scarico a pavimento

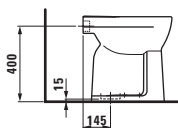
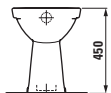
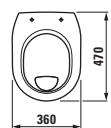

82195.7
Floorstanding WC, washdown, vertical outlet

Stand-WC, Tiefspüler,
 Abgang senkrecht
 WC au sol, à chasse directe,
 sortie verticale
 Vaso a pavimento, a cacciata,
 scarico a pavimento

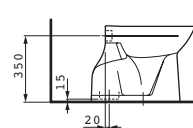
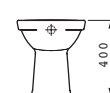
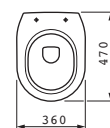

LAUFEN PRO



82195.9
Floorstanding WC, washout, vertical outlet
Stand-WC, Flachspüler,
Abgang senkrecht
WC au sol, à fond plat,
sortie verticale
Vaso a pavimento, a fondo piatto,
scarico a pavimento

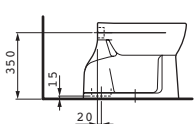
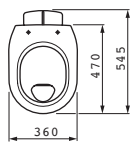

82595.6
Floorstanding WC, washout, horizontal outlet
Stand-WC, Flachspüler,
Abgang waagrecht
WC au sol, à fond plat,
sortie horizontale
Vaso a pavimento, a fondo piatto,
scarico a parete

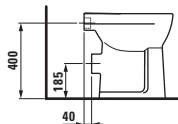

LAUFEN PRO

WC seats and covers for WCs

WC-Sitze für WCs

Sièges et abattants pour WCs

Sedile per vasi

82095.0, 82095.1, 82095.2, 82095.3, 82095.4, 82095.5, 82295.1, 82495.5, 82495.6, 82495.7, 82495.8, 82495.9



89195.0

WC seat and cover LAUFEN pro, removable

WC-Sitz mit Deckel LAUFEN pro, abnehmbar

Siège et abattant LAUFEN pro, amovibles

Sedile con coperchio LAUFEN pro, estraibile

89195.1

WC seat and cover LAUFEN pro, removable, with lowering system

WC-Sitz mit Deckel LAUFEN pro, abnehmbar, mit Absenkautomatik

Siège et abattant LAUFEN pro, amovibles, avec système d'abaissement

Sedile con coperchio LAUFEN pro, estraibile, con sistema a caduta rallentata



89395.2

WC seat and cover Universal, removable

WC-Sitz mit Deckel Universal, abnehmbar

Siège et abattant Universal, amovibles

Sedile con coperchio Universal, estraibile

89395.3

WC seat and cover Universal, removable, with lowering system

WC-Sitz mit Deckel Universal, abnehmbar, mit Absenkautomatik

Siège et abattant Universal, amovibles, avec système d'abaissement

Sedile con coperchio Universal, estraibile, con sistema a caduta rallentata



89895.0

WC seat and cover, barrier-free, removable

WC-Sitz mit Deckel, barrierefrei, abnehmbar

Siège et abattant, sans limite, amovibles

Sedile con coperchio, senza barriera, estraibile



89895.1

WC seat, barrier-free, removable

WC-Sitz, barrierefrei, abnehmbar

Siège, sans limite, amovibles

Sedile, senza barriera, estraibile

WC seats and covers for WCs

WC-Sitze für WCs

Sièges et abattants pour WCs

Sedile per vasi

82095.0, 82095.1, 82095.2, 82095.5, 82195.6, 82195.7, 82195.8, 82195.9, 82295.1, 82495.5, 82495.6, 82495.7, 82495.8, 82495.9, 82595.5, 82595.6, 82595.7



89295.0

WC seat LAUFEN pro

WC-Sitz LAUFEN pro

Siège LAUFEN pro

Sedile LAUFEN pro



89295.1

WC seat and cover LAUFEN pro

WC-Sitz mit Deckel LAUFEN pro

Siège et abattant LAUFEN pro

Sedile con coperchio LAUFEN pro



81195.3
Washbasin, barrier-free
 Waschtisch, barrierefrei
 Lavabo, sans limite
 Lavabo, senza barriere

o/●



Options:
 .104 .109 .142 .156

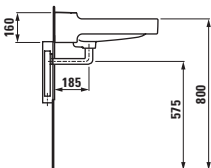
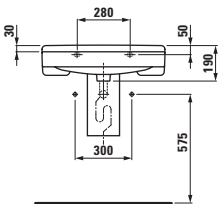
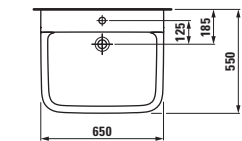

81195.0
Washbasin, barrier-free
 Waschtisch, barrierefrei
 Lavabo, sans limite
 Lavabo, senza barriere

o/●



Options:
 .104 .109 .142 .156

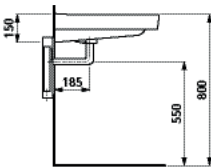
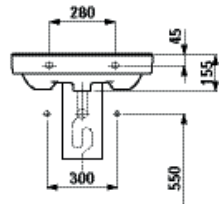
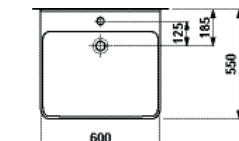

82196.0
Wall-hung WC, rimless, washdown
 Wand-WC, spülrandlos, Tiefspüler
 WC suspendu, rimless, à chasse directe
 Vaso sospeso, rimless, a cacciata

89895.0
Seat and cover, barrier-free
 WC-Sitz mit Deckel, barrierefrei
 Siège et abattant, sans limite
 Sedile con coperchio, senza barriere

89895.1
Seat without cover, barrier-free
 WC-Sitz ohne Deckel, barrierefrei
 Siège sans abattant, sans limite
 Sedile senza coperchio, senza barriere

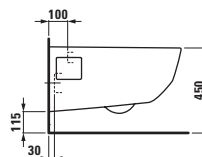
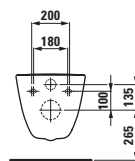
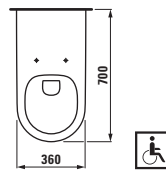

82095.4
Wall-hung WC, washdown
 Wand-WC, Tiefspüler
 WC suspendu, à chasse directe
 Vaso sospeso, a cacciata

89895.0
Seat and cover, barrier-free
 WC-Sitz mit Deckel, barrierefrei
 Siège et abattant, sans limite
 Sedile con coperchio, senza barriere

89895.1
Seat without cover, barrier-free
 WC-Sitz ohne Deckel, barrierefrei
 Siège sans abattant, sans limite
 Sedile senza coperchio, senza barriere

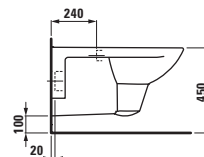
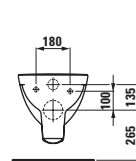
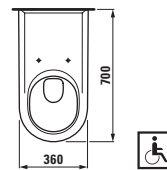



82095.3

Wall-hung WC, washout

Wand-WC, Flachspüler
WC suspendu, à fond plat
Vaso sospeso, a fondo piatto

89895.0

Seat and cover, barrier-free

WC-Sitz mit Deckel, barrierefrei
Siège et abattant, sans limite
Sedile con coperchio, senza barriere

89895.1

Seat without cover, barrier-free

WC-Sitz ohne Deckel, barrierefrei
Siège sans abattant, sans limite
Sedile senza coperchio, senza barriere

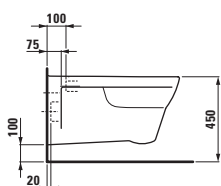
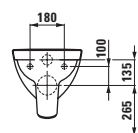

Caprino Plus, siphonic urinal

Caprino Plus, Absauge-Urinal
Caprino Plus, urinoir à effet siphonique
Caprino Plus, orinatoio sifonico

84206.1

With concealed water inlet

Zulauf innen
Entrée d'eau intérieure
Entrata acqua nascosta

84206.2

With external water inlet

Zulauf außen
Entrée d'eau extérieure
Con entrata acqua esterna
Alimentazione a batteria

Options:

.000 .400 **with fly**
mit Zielfliege
avec mouche
con mosca

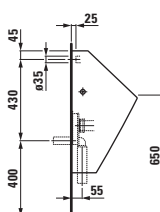
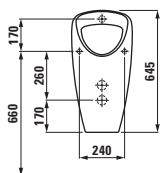
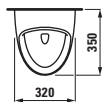

Caprino Plus siphonic urinal, concealed water inlet, with electronic urinal control, vandalproof

Caprino Plus, Absauge-Urinal, Zulauf innen, mit elektronischer Urinalsteuerung, vandalensicher
Caprino Plus, urinoir à effet siphonique, entrée d'eau intérieure, avec commande électronique, protection contre le vandalisme
Caprino Plus, orinatoio sifonico, con entrata acqua nascosta, comando elettronico, antivandalismo

84206.5

Mains operated

Netzbetrieb
Alimentation réseau
Alimentazione a rete

84206.6

Battery operated

Batteriebetrieb
Alimentation batterie



84760.0

Rion, urinal divison

Rion, Urinaltrennwand
Rion, paroi de séparation pour urinoir
Rion, aletta divisora fra orinatoio

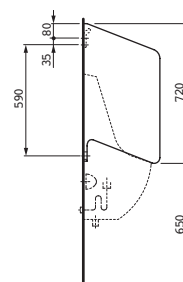
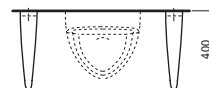

MATCHING MATRIX

SEAT & COVER

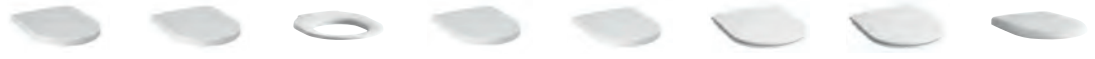

	89195.0 Special	89195.1 Special	89295.0 Special	89695.0 Special	89695.1 Special	89896.5 Slim	89896.6 Slim	89395.2 Universal
Laufen pro								
easily removable	•	•		•	•	•	•	•
hollow space fix				•	•	•	•	
lowering system		•			•		•	
barrier-free								
WCs								
82095.0	•	•	•					•
82095.1	•	•	•			•	•	•
82095.2	•	•	•					•
82095.3	•		•					•
82095.4	•		•					•
82095.5	•	•	•			•	•	•
82095.6				•	•	•	•	
82095.8								
82095.9				•	•	•	•	
82096.1								
82096.2								
82096.4				•	•	•	•	
82096.5				•	•	•	•	
82096.6				•	•	•	•	
82195.6	•	•	•					•
82195.7	•	•	•					•
82195.8	•	•	•					•
82195.9	•	•	•					•
82196.0								
82295.1	•	•	•					•
82295.2				•	•	•	•	
82495.5	•	•	•			•	•	•
82495.6	•	•	•					•
82495.7	•	•	•					•
82495.8	•	•	•			•	•	•
82495.9	•	•	•			•	•	•
82595.2				•	•			
82595.5	•	•	•			•	•	•
82595.6	•	•	•			•	•	•
82595.7	•	•	•			•	•	•



89395.3 Universal	89395.4 Universal	89395.5 Universal	89395.6 Universal	89395.7 Universal	89295.1 Standard	89895.0 Liberty	89895.1 Liberty	89196.0 pro S	89196.1 pro S
•		•	•	•	•	•	•	•	•
•		•	•	•		•	•		•
•	•				•				
•	•				•				
•	•				•				
					•	•	•		
					•	•	•		
•	•				•				
		•	•	•					
		•	•	•					
								•	•
								•	•
		•	•	•					
		•	•	•					
		•	•	•					
•	•				•				
•	•				•				
•	•				•				
•	•				•				
						•	•		
•	•				•				
		•	•	•					
•	•				•				
•	•				•				
•	•				•				
•	•				•				
		•	•	•					
•	•				•				
•	•				•				
•	•				•				

LAUFEN PRO, ACRYLIC BATHTUBS



23395.0
Bathtub, drop-in version, 4 mm sanitary acrylic, 1600x700 mm
 Badewanne, Einbauversion, 4 mm Sanitäracryl, 1600x700 mm
 Baignoire, version encastrée, acrylique sanitaire 4 mm, 1600x700 mm
 Vasca, versione da incasso, in acrilico sanitario 4 mm, 1600x700 mm

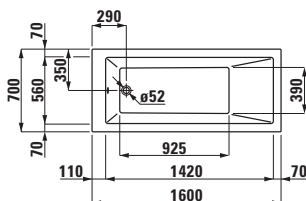

23395.1 **
Bathtub, with frame, 4 mm sanitary acrylic, 1600x700 mm
 Badewanne, mit Fussgestell, 4 mm Sanitäracryl, 1600x700 mm
 Baignoire, avec piétement, acrylique sanitaire 4 mm, 1600x700 mm
 Vasca, con base, in acrilico sanitario 4 mm, 1600x700 mm

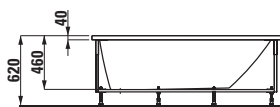
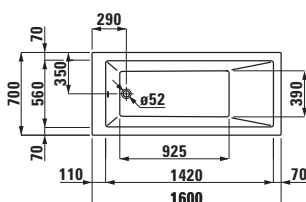

23395.5 **
Bathtub for right-hand corner with L front panel, version left
 Badewanne für die rechte Ecke mit L-Schürze links
 Baignoire version d'angle droite avec tablier en L, version gauche
 Vasca modello angolare dx con pannello a L, lato corto a sinistra

23395.6 **
Bathtub for left-hand corner with L front panel, version right
 Badewanne für die linke Ecke mit L-Schürze rechts
 Baignoire version d'angle gauche avec tablier en L, version droite
 Vasca modello angolare sx con pannello a L, lato corto a destra



23095.0
Bathtub, drop-in version, 4 mm sanitary acrylic, 1700x700 mm
 Badewanne, Einbauversion, 4 mm Sanitäracryl, 1700x700 mm
 Baignoire, version encastrée, acrylique sanitaire 4 mm, 1700x700 mm
 Vasca, versione da incasso, in acrilico sanitario 4 mm, 1700x700 mm

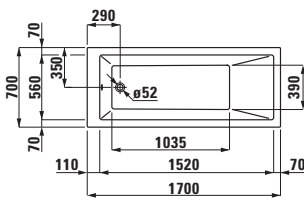

23095.1 **
Bathtub, with frame, 4 mm sanitary acrylic, 1700x700 mm
 Badewanne, mit Fussgestell, 4 mm Sanitäracryl, 1700x700 mm
 Baignoire, avec piétement, acrylique sanitaire 4 mm, 1700x700 mm
 Vasca, con base, in acrilico sanitario 4 mm, 1700x700 mm

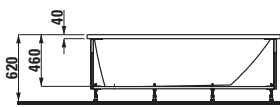
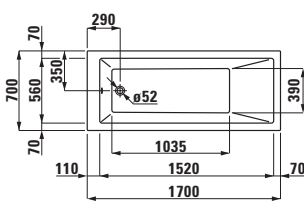

23095.5 **
Bathtub for right-hand corner with L front panel, version left
 Badewanne für die rechte Ecke mit L-Schürze links
 Baignoire version d'angle droite avec tablier en L, version gauche
 Vasca modello angolare dx con pannello a L, lato corto a sinistra

23095.6 **
Bathtub for left-hand corner with L front panel, version right
 Badewanne für die linke Ecke mit L-Schürze rechts
 Baignoire version d'angle gauche avec tablier en L, version droite
 Vasca modello angolare sx con pannello a L, lato corto a destra



23195.0
Bathtub, drop-in version, 4 mm sanitary acrylic, 1700x750 mm
 Badewanne, Einbauversion, 4 mm Sanitäracryl, 1700x750 mm
 Baignoire, version encastrée, acrylique sanitaire 4 mm, 1700x750 mm
 Vasca, versione da incasso, in acrilico sanitario 4 mm, 1700x750 mm

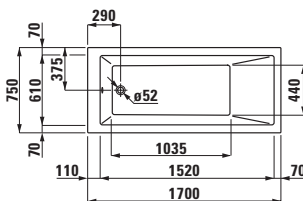

23195.1 **
Bathtub, with frame, 4 mm sanitary acrylic, 1700x750 mm
 Badewanne, mit Fussgestell, 4 mm Sanitäracryl, 1700x750 mm
 Baignoire, avec piétement, acrylique sanitaire 4 mm, 1700x750 mm
 Vasca, con base, in acrilico sanitario 4 mm, 1700x750 mm

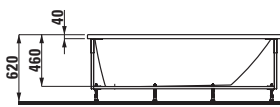
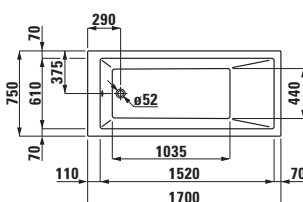

23195.5 **
Bathtub for right-hand corner with L front panel, version left
 Badewanne für die rechte Ecke mit L-Schürze links
 Baignoire version d'angle droite avec tablier en L, version gauche
 Vasca modello angolare dx con pannello a L, lato corto a sinistra

23195.6 **
Bathtub for left-hand corner with L front panel, version right
 Badewanne für die linke Ecke mit L-Schürze rechts
 Baignoire version d'angle gauche avec tablier en L, version droite
 Vasca modello angolare sx con pannello a L, lato corto a destra



23295.0
Bathtub, drop-in version, 4 mm sanitary acrylic, 1800x800 mm
 Badewanne, Einbauversion, 4 mm Sanitäracryl, 1800x800 mm
 Baignoire, version encastrée, acrylique sanitaire 4 mm, 1800x800 mm
 Vasca, versione da incasso, in acrilico sanitario 4 mm, 1800x800 mm

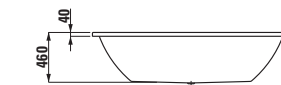
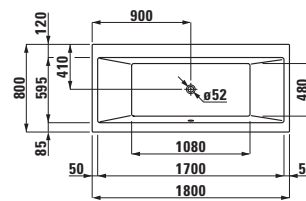

23295.1 **
Bathtub, with frame, 4 mm sanitary acrylic, 1800x800 mm
 Badewanne, mit Fussgestell, 4 mm Sanitäracryl, 1800x800 mm
 Baignoire, avec piétement, acrylique sanitaire 4 mm, 1800x800 mm
 Vasca, con base, in acrilico sanitario 4 mm, 1800x800 mm

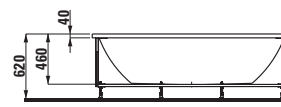
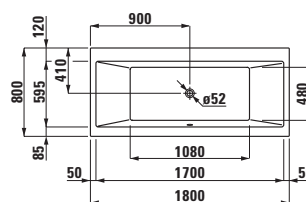

23295.5 **
Bathtub for right-hand corner with L front panel, version left
 Badewanne für die rechte Ecke mit L-Schürze links
 Baignoire version d'angle droite avec tablier en L, version gauche
 Vasca modello angolare dx con pannello a L, lato corto a sinistra

23295.6 **
Bathtub for left-hand corner with L front panel, version right
 Badewanne für die linke Ecke mit L-Schürze rechts
 Baignoire version d'angle gauche avec tablier en L, version droite
 Vasca modello angolare sx con pannello a L, lato corto a destra

LAUFEN PRO, ACRYLIC BATHTUBS



23495.0
Bathtub, drop-in version, 4 mm sanitary acrylic, 1900x900 mm
 Badewanne, Einbauversion, 4 mm Sanitäracryl, 1900x900 mm
 Baignoire, version encastrée, acrylique sanitaire 4 mm, 1900x900 mm
 Vasca, versione da incasso, in acrilico sanitario 4 mm, 1900x900 mm

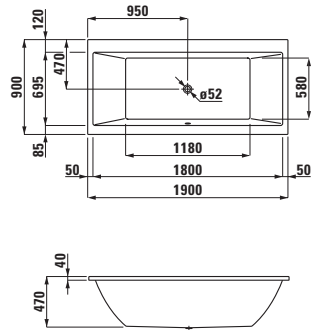

23495.1 **
Bathtub, with frame, 4 mm sanitary acrylic, 1900x900 mm
 Badewanne, mit Fussgestell, 4 mm Sanitäracryl, 1900x900 mm
 Baignoire, avec piétement, acrylique sanitaire 4 mm, 1900x900 mm
 Vasca, con base, in acrilico sanitario 4 mm, 1900x900 mm

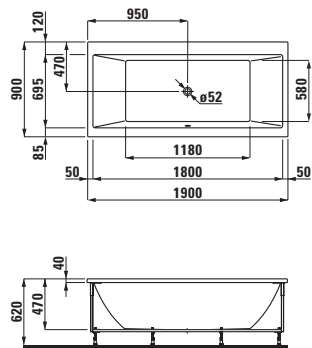

23495.5 **
Bathtub for right-hand corner with L front panel, version left
 Badewanne für die rechte Ecke mit L-Schürze links
 Baignoire version d'angle droite avec tablier en L, version gauche
 Vasca modello angolare dx con pannello a L, lato corto a sinistra

23495.6 **
Bathtub for left-hand corner with L front panel, version right
 Badewanne für die linke Ecke mit L-Schürze rechts
 Baignoire version d'angle gauche avec tablier en L, version droite
 Vasca modello angolare sx con pannello a L, lato corto a destra

Options bathtubs with whirlsystem

Ausführungen Badewannen mit Whirlsystem
 Exécutions des baignoires avec balnéo
 Versioni delle vasche con sistema idromassaggio

.000 Without whirlsystem

Ohne Whirlsystem
 Sans balnéo
 Senza sistema idromassaggio

Whirlsystems with sensor

Elektronische Sensorsteuerung
 Commande électronique avec détecteur
 Sistemi idromassaggio con sensore

	Air massage/Luftmassage/Aéromassage/ Idromassaggio a getto d'aria	Hydromassage/Wassermassage/ Hydromassage/Idromassaggio aria/acqua	Disinfection/Desinfektion/ Désinfection/igienizzazione	Heating/Heizung/ Chauffage/Riscaldatore	LED light/LED-Licht/ Eclairage LED/Luce a LED	Steam/Dampf/Vapeur/ Umidità	Display/Display/Affichege/ Display	Music/Musik/ Musique/Musica
Option .605	x							
Option .615					x			
Option .625	x				x			
Option .635		x						
Option .645	x	x						
Option .675	x	x			x			
Option .695	x	x	x		x			

Bathtub and panel colours

Farben Badewannen und Schürzen
 Couleurs baignoires et tabliers
 Colori di vasche e pannelli



** Also available with whirlsystem

Auch mit Whirlsystem erhältlich
 Egalement disponible avec système balnéo
 Disponibile anche con sistema idromassaggio

LAUFEN PRO, ACRYLIC BATHTUBS



23595.0
Bathtub, drop-in version, 3,2 mm sanitary acrylic, 1600x700 mm

Badewanne, Einbauversion, 3,2 mm Sanitäracryl, 1600x700 mm
 Baignoire, version encastrée, 3,2 mm acrylique sanitaire, 1600x700 mm
 Vasca, versione da incasso, in acrilico sanitario 3,2 mm, 1600x700 mm

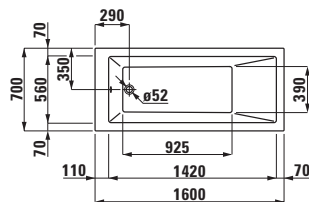

23695.0
Bathtub, drop-in version, 3,2 mm sanitary acrylic, 1700x700 mm

Badewanne, Einbauversion, 3,2 mm Sanitäracryl, 1700x700 mm
 Baignoire, version encastrée, acrylique sanitaire 3,2 mm, 1700x700 mm
 Vasca, versione da incasso, in acrilico sanitario 3,2 mm, 1700x700 mm

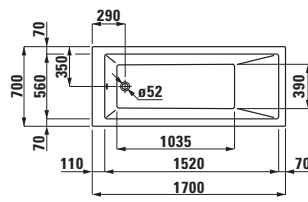

23795.0
Bathtub, drop-in version, 3,2 mm sanitary acrylic, 1700x750 mm

Badewanne, Einbauversion, 3,2 mm Sanitäracryl, 1700x750 mm
 Baignoire, version encastrée, acrylique sanitaire 3,2 mm, 1700x750 mm
 Vasca, versione da incasso, in acrilico sanitario 3,2 mm, 1700x750 mm

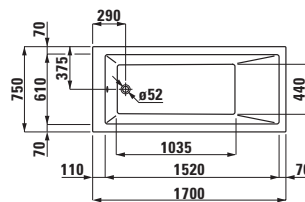

23895.0
Bathtub, drop-in version, 3,2 mm sanitary acrylic, 1800x800 mm

Badewanne, Einbauversion, 3,2 mm Sanitäracryl, 1800x800 mm
 Baignoire, version encastrée, acrylique sanitaire 3,2 mm, 1800x800 mm
 Vasca, versione da incasso, in acrilico sanitario 3,2 mm, 1800x800 mm

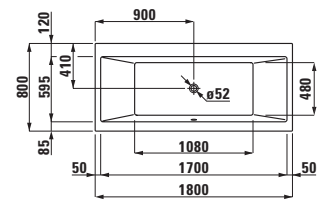

For bathtubs

Für Badewannen
 Pour baignoire
 Per vasca
 23595.0, 23695.0, 23795.0, 23895.0

Side Panels, ABS material

Seitenschürze, ABS Material
 Tablier latéral, matériau ABS
 Pannello laterale, materiale ABS
 29610.6 70x60 cm
 29611.6 75x60 cm
 29612.6 80x60 cm

29616.0

Installation kit for side panels

Befestigungs-Set für Seitenschürzen
 Kit de fixation pour les tabliers latéraux
 Set di fissaggio per i pannelli di rivestimento laterali

Front Panels, ABS material

Frontschürze, ABS Material
 Tablier avant, matériau ABS
 Pannello frontale, materiale ABS
 29613.7 160x60 cm
 29613.8 170x60 cm
 29613.9 180x60 cm

29616.9

Installation kit for front panels

Befestigungs-Set für Frontschürzen
 Kit de fixation pour les tabliers avant
 Set di fissaggio per i pannelli frontali

29616.8

Standard feet (4 pieces)

Fuss Set (4 Stück)
 Kit de pied (4 pièces)
 Set di piedini (4 pezzi)

Bathtub and panel colours

Farben Badewannen und Schürzen
 Couleurs baignoires et tabliers
 Colori di vasche e pannelli

Acrylic, Acryl, acrylique, acrilico

 **.000 White**
 Weiß
 Blanc
 Bianco

Steel, Stahl, acier, acciaio

 **.600 White anti-slip**
 Weiß antislip
 Blanc antiglisse
 Bianco antiscivolo

LAUFEN PRO, STEEL BATHTUBS



22095.0.040

Steel bathtub, 1500x700 mm, 3 mm enamelled steel, with anti-noise-pads

Stahlbadewanne, 1500x700 mm, Stahl-Email 3 mm, mit Anti-Noise-Pads

Baignoire acier, 1500x700 mm, acier émaillé de 3 mm, avec patins antibruit

Vasca in acciaio, 1500x700 mm, acciaio smaltato 3 mm, con cuscinetti antirumore

22095.3.040

As above, with holes for handles (distance of holes 208 mm)

Wie oben, mit Löchern für Griffmontage (Abstand der Löcher 208 mm)

Comme ci-dessus, avec trous pour poignée (distance des trous 208 mm)
Come sopra, con fori per maniglia (distanza tra i fori 208 mm)

29410.2.004.000.1

Bathtub handles, chrome plated (distance of holes 208 mm)

Badewannengriffe, verchromt (Abstand der Löcher 208 mm)

Poignées pour baignoire, chromées (distance des trous 208 mm)

Maniglie per vasca, cromate (distanza tra i fori 208 mm)

29617.2.000.000.1

Feet for bathtub

Füße für Badewanne

Pieds pour baignoire

Piedi per vasca

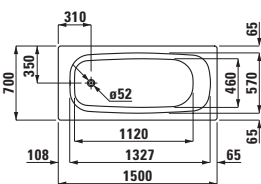

22195.0.040

Steel bathtub, 1500 x 700 mm, 3 mm enamelled steel, with anti-noise-pads

Stahlbadewanne, 1500 x 700 mm, Stahl-Email 3 mm, mit Anti-Noise-Pads

Baignoire acier, 1500 x 700 mm, acier émaillé de 3 mm, avec patins antibruit

Vasca in acciaio, 1500 x 700 mm, acciaio smaltato 3 mm, con cuscinetti antirumore

22195.3.040

As above, with holes for handles (distance of holes 208 mm)

Wie oben, mit Löchern für Griffmontage (Abstand der Löcher 208 mm)

Comme ci-dessus, avec trous pour poignée (distance des trous 208 mm)
Come sopra, con fori per maniglia (distanza tra i fori 208 mm)

29410.2.004.000.1

Bathtub handles, chrome plated (distance of holes 208 mm)

Badewannengriffe, verchromt (Abstand der Löcher 208 mm)

Poignées pour baignoire, chromées (distance des trous 208 mm)

Maniglie per vasca, cromate (distanza tra i fori 208 mm)

29617.2.000.000.1

Feet for bathtub

Füße für Badewanne

Pieds pour baignoire

Piedi per vasca

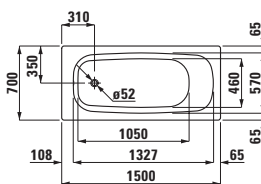

22295.0.040

Steel bathtub, 1500 x 750 mm, 3 mm enamelled steel, with anti-noise-pads

Stahlbadewanne, 1500 x 750 mm, Stahl-Email 3 mm, mit Anti-Noise-Pads

Baignoire acier, 1500 x 750 mm, acier émaillé de 3 mm, avec patins antibruit

Vasca in acciaio, 1500 x 750 mm, acciaio smaltato 3 mm, con cuscinetti antirumore

22295.3.040

As above, with holes for handles (distance of holes 208 mm)

Wie oben, mit Löchern für Griffmontage (Abstand der Löcher 208 mm)

Comme ci-dessus, avec trous pour poignée (distance des trous 208 mm)
Come sopra, con fori per maniglia (distanza tra i fori 208 mm)

29410.2.004.000.1

Bathtub handles, chrome plated (distance of holes 208 mm)

Badewannengriffe, verchromt (Abstand der Löcher 208 mm)

Poignées pour baignoire, chromées (distance des trous 208 mm)

Maniglie per vasca, cromate (distanza tra i fori 208 mm)

29617.2.000.000.1

Feet for bathtub

Füße für Badewanne

Pieds pour baignoire

Piedi per vasca

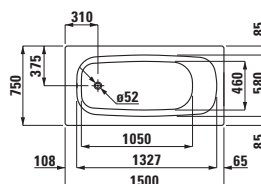

22395.0.040

Steel bathtub, 1600x700 mm, 3,5 mm enamelled steel, with anti-noise-pads

Stahlbadewanne, 1600x700 mm, Stahl-Email 3,5 mm, mit Anti-Noise-Pads

Baignoire acier, 1600x700 mm, acier émaillé de 3,5 mm, avec patins antibruit

Vasca in acciaio, 1600x700 mm, acciaio smaltato 3,5 mm, con cuscinetti anti-rumore

22395.3.040

As above, with holes for handles (distance of holes 208 mm)

Wie oben, mit Löchern für Griffmontage (Abstand der Löcher 208 mm)

Comme ci-dessus, avec trous pour poignée (distance des trous 208 mm)
Come sopra, con fori per maniglia (distanza tra i fori 208 mm)

29618.1.004.000.1

Bathtub handles, chrome plated (distance of holes 208 mm)

Badewannengriffe, verchromt (Abstand der Löcher 208 mm)

Poignées pour baignoire, chromées (distance des trous 208 mm)

Maniglie per vasca, cromate (distanza tra i fori 208 mm)

29617.1.000.000.1

Feet for bathtub

Füße für Badewanne

Pieds pour baignoire

Piedi per vasca

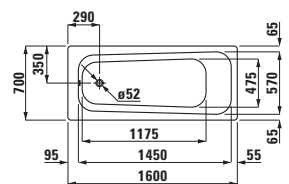

LAUFEN PRO, STEEL BATHTUBS



22495.0.040

Steel bathtub, 1700x700 mm, 3,5 mm enamelled steel, with anti-noise-pads

Stahlbadewanne, 1700x700 mm, Stahl-Email 3,5 mm, mit Anti-Noise-Pads

Baignoire acier, 1700x700 mm, acier émaillé de 3,5 mm, avec patins antibruit

Vasca in acciaio, 1700x700 mm, acciaio smaltato 3,5 mm, con cuscinetti anti-rumore

22495.3.040

As above, with holes for handles (distance of holes 208 mm)

Wie oben, mit Löchern für Griffmontage (Abstand der Löcher 208 mm)

Comme ci-dessus, avec trous pour poignée (distance des trous 208 mm)

Come sopra, con fori per maniglia (distanza tra i fori 208 mm)

29618.1.004.000.1

Bathtub handles, chrome plated (distance of holes 208 mm)

Badewannengriffe, verchromt (Abstand der Löcher 208 mm)

Poignées pour baignoire, chromées (distance des trous 208 mm)

Maniglie per vasca, cromate (distanza tra i fori 208 mm)

29617.1.000.000.1

Feet for bathtub

Füße für Badewanne

Pieds pour baignoire

Piedi per vasca

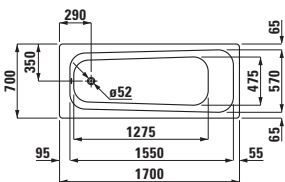

22595.0.040

Steel bathtub, 1700x750 mm, 3,5 mm enamelled steel, with anti-noise-pads

Stahlbadewanne, 1700x750 mm, Stahl-Email 3,5 mm, mit Anti-Noise-Pads

Baignoire acier, 1700x750 mm, acier émaillé de 3,5 mm, avec patins antibruit

Vasca in acciaio, 1700x750 mm, acciaio smaltato 3,5 mm, con cuscinetti anti-rumore

22595.3.040

As above, with holes for handles (distance of holes 208 mm)

Wie oben, mit Löchern für Griffmontage (Abstand der Löcher 208 mm)

Comme ci-dessus, avec trous pour poignée (distance des trous 208 mm)

Come sopra, con fori per maniglia (distanza tra i fori 208 mm)

29618.1.004.000.1

Bathtub handles, chrome plated (distance of holes 208 mm)

Badewannengriffe, verchromt (Abstand der Löcher 208 mm)

Poignées pour baignoire, chromées (distance des trous 208 mm)

Maniglie per vasca, cromate (distanza tra i fori 208 mm)

29617.1.000.000.1

Feet for bathtub

Füße für Badewanne

Pieds pour baignoire

Piedi per vasca

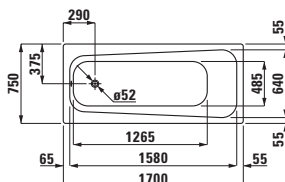

22695.0.040

Steel bathtub, 1700x750 mm, 3,5 mm enamelled steel, with anti-noise-pads

Stahlbadewanne, 1700x750 mm, Stahl-Email 3,5 mm, mit Anti-Noise-Pads

Baignoire acier, 1700x750 mm, acier émaillé de 3,5 mm, avec patins antibruit

Vasca in acciaio, 1700x750 mm, acciaio smaltato 3,5 mm, con cuscinetti anti-rumore

22695.3.040

As above, with holes for handles (distance of holes 232 mm)

Wie oben, mit Löchern für Griffmontage (Abstand der Löcher 232 mm)

Comme ci-dessus, avec trous pour poignée (distance des trous 232 mm)

Come sopra, con fori per maniglia (distanza tra i fori 232 mm)

29618.5.004.000.1

Bathtub handles, chrome plated (distance of holes 232 mm)

Badewannengriffe, verchromt (Abstand der Löcher 232 mm)

Poignées pour baignoire, chromées (distance des trous 232 mm)

Maniglie per vasca, cromate (distanza tra i fori 232 mm)

29617.1.000.000.1

Feet for bathtub

Füße für Badewanne

Pieds pour baignoire

Piedi per vasca

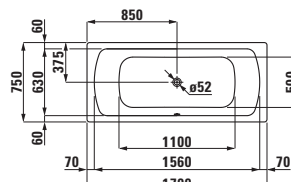

22795.0.040

Steel bathtub, 1800x800 mm, 3,5 mm enamelled steel, with anti-noise-pads

Stahlbadewanne, 1800x800 mm, Stahl-Email 3,5 mm, mit Anti-Noise-Pads

Baignoire acier, 1800x800 mm, acier émaillé de 3,5 mm, avec patins antibruit

Vasca in acciaio, 1800x800 mm, acciaio smaltato 3,5 mm, con cuscinetti anti-rumore

22795.3.040

As above, with holes for handles (distance of holes 232 mm)

Wie oben, mit Löchern für Griffmontage (Abstand der Löcher 232 mm)

Comme ci-dessus, avec trous pour poignée (distance des trous 232 mm)

Come sopra, con fori per maniglia (distanza tra i fori 232 mm)

29618.5.004.000.1

Bathtub handles, chrome plated (distance of holes 232 mm)

Badewannengriffe, verchromt (Abstand der Löcher 232 mm)

Poignées pour baignoire, chromées (distance des trous 232 mm)

Maniglie per vasca, cromate (distanza tra i fori 232 mm)

29617.1.000.000.1

Feet for bathtub

Füße für Badewanne

Pieds pour baignoire

Piedi per vasca

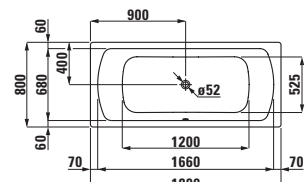

29410.3.016.000.1

Gel pillow, self-adhesive

Gelkissen selbsthaftend

Coussin-gel adhésif

Cuscino in gel autoadesivo



Ceramic colours pro S & liberty

Keramikfarben pro S & liberty
Couleurs céramique pro S & liberty
Colori della ceramica pro S & liberty



.000 White
Weiß
Blanc
Bianco



.400 White LCC
Weiß LCC
Blanc LCC
Bianco LCC
(Laufen Clean Coat)

Ceramic colour pro & B & A

Keramikfarbe pro & B & A
Couleur céramique pro & B & A
Colore della ceramica pro & B & A



.000 White
Weiß
Blanc
Bianco



.400 White LCC
Weiß LCC
Blanc LCC
Bianco LCC
(Laufen Clean Coat)



.757 White Matt
Weiß matt
Blanc mat
Bianco opaco



.018 Bahamabeige
Beige Bahama



.037 Manhattan



.049 Pergamon

Types of washbasins

Ausführungen Waschtische
Exécutions lavabos
Modelli lavabi

.104 1 tap hole
● 1 Hahnloch
1 trou pour la robinetterie
1 foro per la rubinetteria

.105 1 tap hole left
● 1 Hahnloch links
1 trou pour la robinetterie à gauche
1 foro per la rubinetteria a sinistra

.106 1 tap hole right
● 1 Hahnloch rechts
1 trou pour la robinetterie à droite
1 foro per la rubinetteria a destra

.107 2 tap holes
●● 2 Hahnlöcher
2 trous pour la robinetterie
2 fori per la rubinetteria

.108 3 tap holes
●●● 3 Hahnlöcher
3 trous pour la robinetterie
3 fori per la rubinetteria

.109 Without tap hole
○ Ohne Hahnloch
Non percé
Senza foro per la rubinetteria

.112 Without tap hole, without overflow
Ohne Hahnloch, ohne Überlauf
Non percé, sans trop-plein
Senza foro per la rubinetteria, senza troppopieno

.142 No tap hole, no overflow, no open drain
Ohne Hahnloch, ohne Überlauf, ohne Öffnung im Ablaufventil
Non percé, sans trop-plein apparent, sans ouverture dans la valve d'écoulement
Senza foro per la rubinetteria, senza troppopieno, senza apertura nella valvola di scarico

.155 Without tap hole, glazed inside and outside
Ohne Hahnloch, innen und außen glasiert
Non percé, coupé sur 1 côté, émaillé sur l'intérieur et l'extérieur
Senza foro per la rubinetteria, interno ed esterno smaltato

.156 With tap hole, no overflow, no open drain
Mit Hahnloch, ohne Überlauf, ohne Öffnung im Ablaufventil
Avec trou pour la robinetterie, sans trop-plein apparent, sans ouverture dans la valve d'écoulement
Con foro per la rubinetteria, senza troppopieno, senza apertura nella valvola di scarico

.158 3 tap holes, without overflow
●●● 3 Hahnlöcher, ohne Überlauf
3 trous pour la robinetterie, sans trop-plein
3 fori per la rubinetteria, senza troppopieno

The illustrated colours only approximately correspond to the actual shades. The bathroom layouts shown here are purely decorative and do not reflect all the technical requirements. The decorative parts used are not included in our commercial offer.

Die Farbbildungen entsprechen nur in etwa den tatsächlichen Farbtönen. Die hier gezeigten Badmilieus sind rein dekorativ und berücksichtigen nicht alle technischen Anforderungen. Unser Angebot beinhaltet nicht die verwendete Dekoration.

Les photos couleur ne correspondent que partiellement aux teintes effectives. Les ambiances reproduites ici sont simplement décoratives, les exigences techniques d'installation n'ont pas toujours été prises en compte. La décoration utilisée ne fait pas partie de notre offre commerciale.

I colori qui illustrati non corrispondono esattamente alle tonalità effettive. Gli ambienti qui riprodotti sono puramente decorativi e non tengono conto di tutte le specifiche tecniche. Gli articoli d'arredo usati non fanno parte della nostra offerta commerciale.

It is possible that not all products, sizes or colours are available in every country. The price list of your LAUFEN subsidiary is the most accurate reference point for product availability. Delivery periods may also differ.

Unter Umständen sind nicht alle Produkte, Größen oder Farben in jedem Land verfügbar. Bitte nutzen Sie die Preisliste der jeweiligen LAUFEN Niederlassung als Referenz für das verfügbare Produktsortiment. Auch die jeweiligen Lieferzeiten können von Land zu Land abweichen.

Il se peut que les produits ne soient pas tous disponibles dans chaque pays dans toutes les dimensions et coloris. La liste de prix de votre filiale LAUFEN est la référence la plus sûre en ce qui concerne la disponibilité des produits. Les délais de livraisons peuvent également varier d'un pays à l'autre.

È possibile che non tutti i prodotti, le misure e i colori siano ugualmente disponibili in ogni Paese. Si prega di utilizzare il listino prezzi della vostra filiale LAUFEN come riferimento per la gamma di prodotti disponibili. Anche i tempi di consegna possono variare da un Paese all'altro.

We reserve the right to make technical changes without prior notice. Registered design.

Technische Änderungen sind vorbehalten. Design geschützt.

Sous réserve de modifications techniques. Modèle déposé.

Con riserva di apportare modifiche tecniche. Modello depositato.



LAUFEN's 4.5/3-litre toilets meet all functional requirements defined by international standards EN 997 Class 1 Type 5, EN 997 Class 2 and SAI/Wels 4 Stars. Please take into consideration your local requirements.

LAUFEN 4.5/3L-WCs erfüllen die geltenden internationalen Standards nach EN 997 Class 1 Type 5, EN 997 Class 2 und SAI/Wels 4 Stars. Beachten Sie bitte Ihre lokalen Bestimmungen, welche von Land zu Land unterschiedlich sein können.

Les toilettes 4,5/3 litres de LAUFEN sont conformes a toutes les exigences de fonctionnement définies dans les standards internationaux EN 997 Classe 1 Type 5, EN 997 Classe 2 et SAI/Wels 4 étoiles. Veuillez tenir compte du fait que les exigences locales peuvent varier d'un pays a l'autre.

I vasi LAUFEN da 4,5/3 litri soddisfano tutti i requisiti funzionali definiti dalle norme internazionali EN 997 Classe 1 tipo 5, EN 997 Classe 2 e SAI/Wels 4 Stars. Si prega di tenere conto dei requisiti locali.

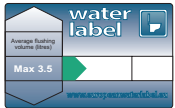

The European water label is a reliable and transparent way for end-users and professionals to raise their awareness about possibilities to reduce water consumption.

European water label ist eine unabhängige und transparente Institution mit dem Ziel, bei Endkunden und Fachleute das Bewusstsein zu den Möglichkeiten der Wasserverbrauch-Reduktion zu wecken.

Le European water label est un organisme indépendant et transparent visant à sensibiliser les consommateurs et les professionnels sur les thèmes de la réduction de la consommation d'eau.

La "European water label" è un modo affidabile e trasparente di destare la consapevolezza di consumatori e professionisti riguardo al vero potenziale di riduzione del consumo d'acqua.



The first two LAUFEN production facilities were successfully ISO 14001 certified and EMAS registered in 1997. Both of these factories were awarded the European Environment Prize 2007 for exemplary environmental management. All the LAUFEN production facilities are now certified with the Environmental and Quality Management Systems ISO 9001 and ISO 14001.

Bereits im Jahr 1997 wurden die ersten beiden Produktionsstätten von LAUFEN erfolgreich ISO 14001 zertifiziert und EMAS überprüft. Die Effizienz dieser beiden Fabriken wurde ausgezeichnet mit dem European Environment Prize 2007 für vorbildliches Umweltmanagement. Heute sind alle LAUFEN Produktionsstätten mit der Umwelt- und Qualitätsmanagement-Norm ISO 9001 und ISO 14001 zertifiziert.

Dès 1997 les deux premiers sites de production LAUFEN passaient avec succès les examens pour la certification ISO 14001 et le contrôle EMAS. L'efficacité de ces deux usines a été distinguée par le prix European Environment Price 2007 récompensant une gestion exemplaire de l'environnement. Aujourd'hui tous les sites de production LAUFEN sont certifiés avec le système de management environnemental et de qualité ISO 9001 et ISO 14001.

I primi due stabilimenti di produzione LAUFEN sono stati certificati secondo lo standard ISO 14001 e registrati EMAS nel 1997.

Entrambe le fabbriche hanno ottenuto il premio europeo per l'ambiente 2007 per la loro esemplare gestione ambientale. Tutti gli impianti di produzione LAUFEN sono ora certificati con i sistemi di gestione ambientale e di qualità ISO 9001 e ISO 14001.



Products with the Q-Plus certification comply with the European standard, as well as with the proven higher Swiss standard laid down by suissetec/VSA. LAUFEN ceramic products comply with this Swiss quality standard and are recommended accordingly.

Produkte mit der Q-Plus-Zertifizierung entsprechen einerseits der Europeanorm und andererseits zusätzlich dem bewährten, höheren Schweizer Standard, welcher durch die suissetec/VSA festgelegt wurde. LAUFEN Keramikprodukte entsprechen diesen schweizerischen Qualitätsmassstäben und haben die entsprechende Zulassungsempfehlung.

Les produits avec certification Q-Plus correspondent à la norme européenne et satisfont en plus aux standards suisses définis par la suissetec/VSA, encore plus élevés et qui ont largement fait leurs preuves. Les produits en céramique signés LAUFEN sont conformes à ces critères de qualité suisses et bénéficient donc des recommandations d'homologation correspondantes.

I prodotti con la certificazione Q-Plus sono conformi sia alla normativa europea sia allo standard svizzero, che prevede requisiti ancora più rigorosi, stabiliti dalla suissetec/VSA. I prodotti in ceramica LAUFEN rispettano questi criteri qualitativi svizzeri e dispongono della relativa certificazione di qualità.



PEFC Certified

This product is from sustainably managed forests and controlled sources

PEFC zertifiziert

Dieses Produkt stammt aus nachhaltig bewirtschafteten Wäldern und kontrollierten Quellen.

Certifié PEFC

Ce produit est issu de forêts gérées durablement et de sources contrôlées.

Certificato PEFC

Questo prodotto è realizzato con materia prima da foreste gestite in maniera sostenibile e da fonti controllate.

www.pefc.org



Since 1998, LAUFEN has continually monitored the use of resources in all its internal and external processes. Targeted measures and appropriate investments promote the efficient and sustainable use of manufacturing resources. Important key environmental protection indicators now clearly show that LAUFEN production sites fulfil the legally-prescribed environmental protection standards, and in most cases also exceed them.

Seit 1998 überprüft LAUFEN all seine internen und externen Prozesse stetig in Bezug auf den Verbrauch von Ressourcen. Gezielte Massnahmen und entsprechende Investitionen fördern eine effiziente und nachhaltige Nutzung der verwendeten Betriebsmittel. Wichtige Schlüsselindikatoren des Umweltschutzes zeigen heute deutlich, dass LAUFEN Produktionsstätten die gesetzlich geforderten Umweltschutzstandards erfüllen, diese in den meisten Fällen sogar noch übertreffen.

Depuis 1998, LAUFEN a contrôlé de façon continue l'utilisation des ressources dans tous ses processus internes et externes. Des mesures ciblées et des investissements appropriés encouragent l'utilisation durable et efficace des ressources de fabrication. Des indicateurs clés de protection de l'environnement montrent aujourd'hui clairement que les sites de LAUFEN sont conformes aux standards de protection de l'environnement légalement prescrits, et dans la plupart des cas vont au-delà de ces normes.

Dal 1998, LAUFEN continua a controllare l'uso di risorse in tutti i propri processi interni ed esterni. Misure mirate e investimenti adeguati promuovono l'uso efficiente e sostenibile delle risorse di produzione. Importanti indicatori chiave della tutela ambientale dimostrano ora chiaramente che gli stabilimenti di produzione LAUFEN soddisfano gli standard di tutela ambientale prescritti dalla legge e in molti casi li superano.

Headquarters:

LAUFEN Bathrooms AG
Wahlenstrasse 46
CH-4242 Laufen
Tel. +41 61 765 71 11
feedback@laufen.ch
www.laufen.com

Export:

LAUFEN Bathrooms AG
Wahlenstrasse 46
CH-4242 Laufen
Tel. +41 61 765 76 09
export@laufen.ch
www.laufen.com/export

Asia:

Roca Sanitaryware Ltd.
Room 2303, 23/F
148 Electric Road
North Point, Hong Kong
Tel. +852 250 624 38
Fax +852 250 624 92
laufenasia@hongkong.laufen.ch
www.laufen.com/export

Oceania:**Australia, New Zealand & other**

Roca Bathroom Products
Australia P/L
Level 10, Suite 1004
46 Market Street
Sydney NSW 2000
Australia
Tel. +61 (2) 9290 2331
aus.admin@roca.net
www.laufen.com.au

Austria:

LAUFEN Austria AG
Mariazeller Strasse 100
A-3150 Wilhelmsburg
Tel. +43 2746 6060
Fax +43 2746 6060 380
office.wi@at.laufen.com
www.laufen.co.at

**Bosnia and Herzegovina,
Croatia, Kosovo, Macedonia,
Montenegro, Serbia, Slovenia:**

INKER d.d.
Industrijska 1
10290 Zaprešić
Tel. +385 1 3310 364
Fax +385 1 3310 275
komercijala@inker.hr
www.laufen.hr

Benelux:

LAUFEN Benelux B.V.
Meidoornkade 2A
NL-3992 AE Houten
Tel. +31 (0)33 450 20 90
info.benelux@laufen.ch
www.laufen.nl
www.laufen.be

Brazil:

Roca Sanitários Brasil Ltda.
Av. 14 de Dezembro,
2.800 - V. Mafalda
CEP: 13206-105
Jundiaí - SP - Brasil
PABX: +55 11 3378 4600
Assistência Técnica: 0800 70 11 510
info.br@laufen.com
www.laufen.com.br

Bulgaria:

Roca Bulgaria AD
5, Pirotska Str.
1301 Sofia, Bulgaria
Tel. +359 2 930 59 10
Fax +359 2 930 59 18
office.sofia@bg.roca.net
www.bg.roca.com

China:

Roca Sanitary Trading
(Shanghai) co. Ltd
Room 503-505, City Gateway
No. 396 North Caoxi Road
Shanghai 200030, China
Tel. +86 21 3368 8822
Fax +86 21 3368 8299
laufen_cn@roca.net.cn
www.cn.laufen.com

Czech Republic:

LAUFEN CZ s.r.o.
V Tüních 3/1637
120 00 Praha 2
Tel. +420 296 337 701
prague.gallery@cz.laufen.com
www.laufen.cz

Estonia, Latvia:

LAUFEN CZ s.r.o.
Pae 25-8
Tallinn, 11414
Estonia
Tel. +372 6 215 569
office.tallinn@ee.laufen.com
www.laufen.ee
www.laufen.lv

France:

Roca S.A.R.L.
Marque LAUFEN
Immeuble le Rond Point
5 Boulevard de l'Oise
F-95015 Cergy Pontoise Cédex
Tel. +33 1 34 40 39 31
Fax +33 1 30 37 02 65
commercial@roca.fr
www.laufen.fr

Germany:

Roca GmbH
Vertrieb LAUFEN
Feincheswiese 17
56424 Staudt
Germany
Tel. +49 26 02 / 94 93 33
Fax +49 26 02 / 94 93 355
info.staudt@de.laufen.com
www.de.laufen.com

Hungary:

LAUFEN CZ s.r.o.
Hungarian Trade Agency
Pasaréti u. 83
H-1026 Budapest
Tel. +36 1 274 05 35
Fax +36 1 391 04 58
office.budapest@hu.laufen.com
www.laufen.hu

India:

Roca Bathroom Products Pvt. Ltd.
3rd Floor, Tower B,
DLF Building No. 10, Phase – II
DLF Cyber City,
Gurgaon – 122002, Haryana
India
Tel. +91 124 4278347-49
Fax +91 124 4278350
Info.laufen@in.roca.com
www.laufen.in

Italy:

LAUFEN CZ s.r.o.
V Tüních 3/1637
CZ-120 00 Praha 2
Tel. +39 02 90016001
Fax. +39 02 90016011
www.laufen.it

Lithuania:

LAUFEN CZ s.r.o.
Užupio g. 30
Vilnius, 01203
Lietuva
Tel. +370 5 215 30 76
office.vilnius@lt.laufen.com
www.laufen.lt

Morocco:

Roca Maroc, S.A.
route de Marrakech, km 2,5
BP 571, 26000 Serrat
Tel. +212 5 23 40 59 41
Fax +212 5 23 40 59 42
www.roca.com

Nordic Countries:**Denmark, Finland, Greenland, Iceland**

LAUFEN Nordic Aps
Tømmervej 2
4600 Køge
Denmark
Tel. +45 56 287 287
info@dk.laufen.com
www.laufen.dk
www.laufen.fi

North America:

LAUFEN Bathrooms North America
Showroom
7610 NE 4th Court, Suite 104
Miami, FL 33138
USA
Toll free phone +1 (866) 696-2493
+1 (305) 357-6130
Toll free fax +1 (866) 628-1760
usa@laufen.com
canada@laufen.com
www.laufen.com/usa
www.laufen.com/ca
www.laufen.com.mx

Norway:

Laufen Norge AS
Syretårnet 41
NO-3048 Drammen
Tel.: +47 32 27 60 70
firmapost@no.laufen.com
www.laufen.no

Poland:

Roca Polska Sp. z o.o.
ul. Wyczółkowskiego 20
44-109 Gliwice
Tel. +48 32 339 41 00
biuro@roca.pl
www.laufen.pl

Portugal:

Roca, S.A., Portugal
Apartado 575, Ponte da Madalena
2416-905 - Leiria, Portugal
Tel. +351 244 720 000
marketing.le@pt.roca.net
www.laufen.pt

Romania:

Roca Obiecte Sanitare S.R.L.
Blvd. Preciziei nr. 1, Sector 6
062202 - Bucharest - Romania
Tel. +4031 822 2310
Fax +4021 318 1418
www.ro.roca.com

Russia:

Roca Rus
Promyshlennaya Str. 7, Tosno
Leningrad region, 187000, Russia
Tel. +7 812 347 94 49
marketing@ru.roca.com
www.laufen.ru

Roca Rus

2nd Khutorskaya, 38A, building 14
Moscow, 127287, Russia
Tel. +7 495 989 65 91
marketing@ru.roca.com
www.laufen.ru

Slovakia:

LAUFEN SK s.r.o.
Štefanovičova 12,
811 04 Bratislava
Tel. +421 2 52 621 024
www.sk.laufen.com

Spain:

Laufen Bathrooms S.A.
C/Covarrubias 23
28010 Madrid
Spain
Phone: +34 900 103 258
info@es.laufen.com
www.laufen.es

Sweden:

Laufen Sverige AB
Kämpegatan 15
SE-41104 Göteborg
Tel. +46 (0) 823 44 44
info@se.laufen.com
www.laufen.se

Switzerland:

Keramik Laufen AG
Wahlenstrasse 46
CH-4242 Laufen
Tel. +41 61 765 71 11
forum@laufen.ch
www.laufen.ch

Ukraine:

LAUFEN CZ s.r.o. Ukraine
Kiev 04128
19, Ak. Tupoleva str., office „Laufen“
Tel. +380 44 499 0620
Fax +380 44 499 0621
office.kiev@ua.laufen.com
www.ua.laufen.com

United Kingdom and Ireland:

ROCA Limited
c/o Laufen Limited
Hermitage Industrial Estate
Samson Road
Coalville
LE67 3FP
Tel. +44 (0)1530 510007
info@uk.laufen.com
www.uk.laufen.com



www.de.laufen.com



www.tc.laufen.com



www.bim.laufen.com
www.facebook.com/laufenbathrooms
www.twitter.com/laufenbathrooms
www.youtube.com/laufenbathrooms1
www.pinterest.com/laufenbathrooms