











# Do not use power tools to assemble this table

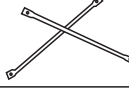
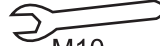
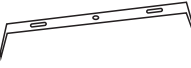

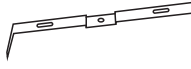
|   |   |   |   |  |   |
|---|---|---|---|--|---|
| A |                 | 1 | I | <br>M6*16     | 4 |
| B |                 | 4 | J | <br>M6*14*1mm | 5 |
| C |                 | 4 | K | <br>M10       | 1 |
| D |                 | 1 | L | <br>M4        | 1 |
| E |                 | 1 | M | <br>M6        | 8 |
| F | <br>Ø10 M6*45mm | 8 |   |  |   |
| G | <br>Ø8 M6*20mm  | 1 |   |  |   |
| H |                  | 8 |   |  |   |

1. Loosely Connect the metal brackets, crossbars, and wood legs. Do not tighten screws until step # 3

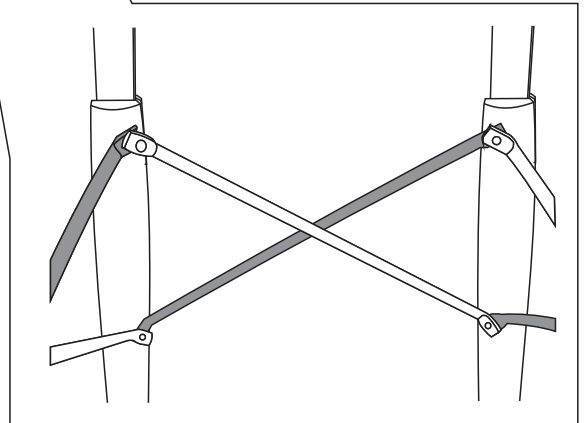
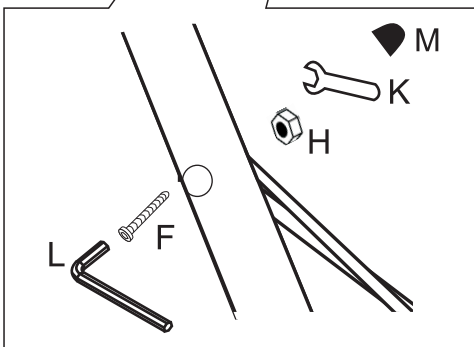
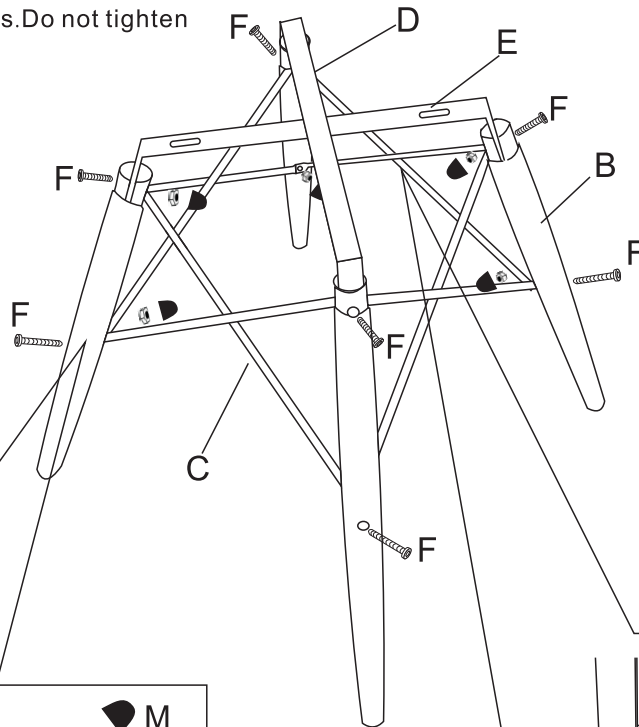

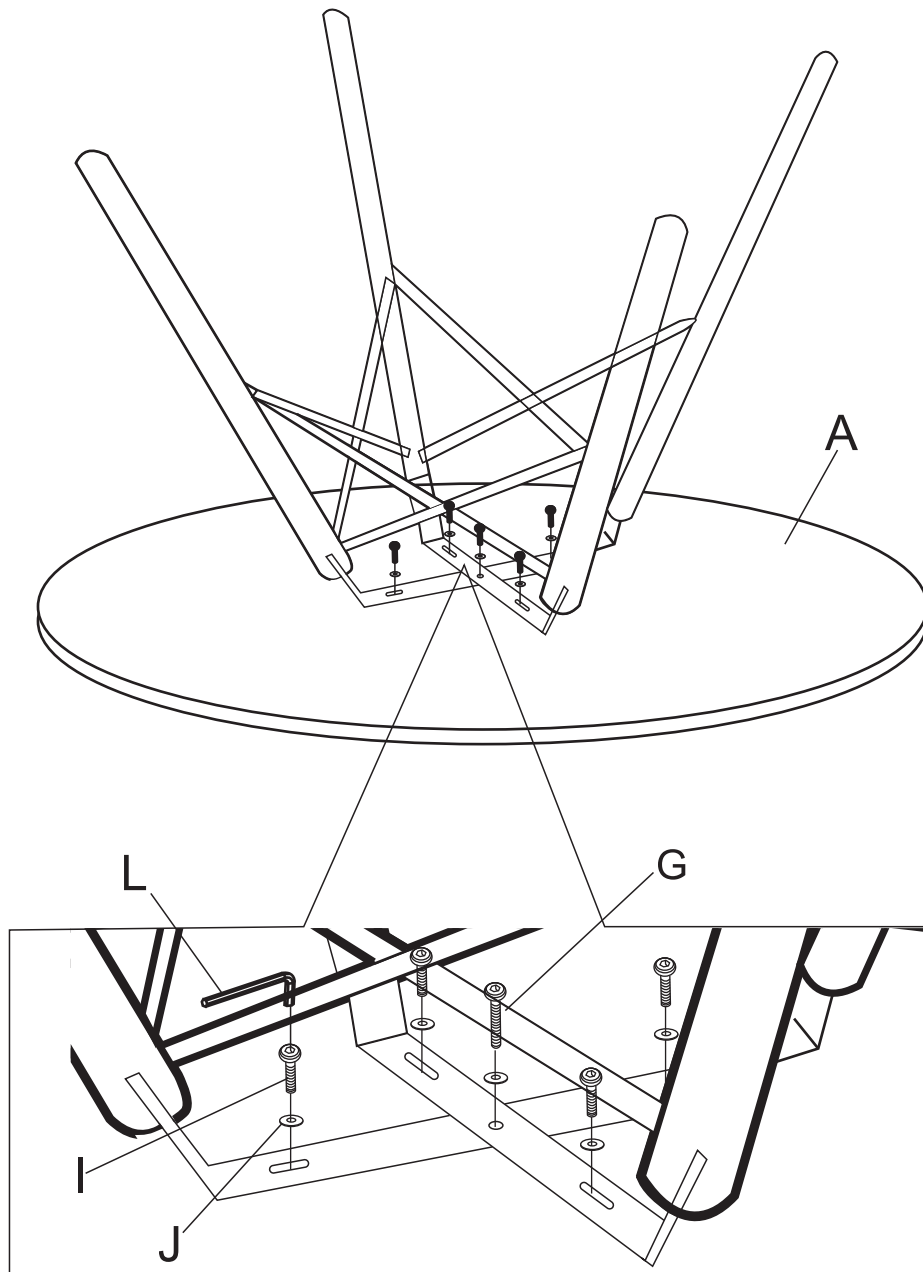

2. Connect the table top to the brackets. Hand tighten screw all of the "I" and "G" screws.
3. Place the table in the upright position and hand tighten screws from step # 1