

CARIMALI

USER'S MANUAL
Translation of original instructions



BlueDot Power

TABLE OF CONTENTS

GENERAL SAFETY WARNINGS	4	2.5.1	Cup station	35
HANDLING AND STORAGE	8	2.5.2	“SI” option	37
PACKAGING CONTENTS	10	2.5.3	“SI+?” option	39
PRIOR CHECKING	10	2.5.4	Cup height/presence	
AFTER RECEIPT	10		sensor	41
POSITIONING	11	2.5.5	Energy save	43
CONNECTION TO THE POWER		2.5.6	Light dose view	44
MAINS	11	2.5.7	Manual delivery stop	46
WATER MAINS CONNECTION	13	2.5.8	RFiD - Replacement of	
MILK CIRCUIT CONNECTION	14		Filter CariPure100	47
Tank filling	15	2.5.9	MDB payment system	48
Boiler filling	16			
RESIDUAL RISKS	16			
IDENTIFICATION	16			
1 INTRODUCTION	17			
1.1 SYMBOLS	17			
1.2 USER TYPES	17			
1.3 INTENDED USE	18			
1.3.1 Reasonably				
foreseeable misuse	18			
2 DESCRIPTION OF THE MACHINE	19			
2.1 MACHINE CONFIGURATIONS ...	19			
2.2 OUTER COMPONENTS	20			
2.3 INNER COMPONENTS	21			
2.3.1 Product containers	23			
2.3.2 Reduced bush				
for containers	23			
2.4 TOUCH SCREEN DISPLAY	24			
2.4.1 Display use	24			
2.4.2 Home page - Power on	25			
2.4.3 Heating waiting screen				
(Boiler-Steam)	26			
2.4.4 Introduction	26			
2.4.5 Selection of drinks to be				
dispensed (example of free				
vend drinks)	27			
2.4.6 Hot water dispensing	28			
2.4.7 Dispensing in process	28			
2.4.8 Delivery completed	29			
2.4.9 Setup menu - Recipe setting				
(examples of drinks)	30			
2.5 DISPLAY VERSIONS	35			
3 TECHNICAL CHARACTERISTICS	51			
3.1 TECHNICAL DATA	51			
3.2 OVERALL DIMENSIONS	52			
4 INSTRUCTIONS FOR USE	53			
4.1 GETTING STARTED	53			
4.1.1 Water tank filling	53			
4.1.2 Product filling	54			
4.2 SWITCHING ON	55			
4.3 DRINK DISPENSING	56			
4.3.1 Boiler filling	56			
4.3.2 Dispensing circuit washing ..	57			
5 ORDINARY MAINTENANCE	58			
5.1 EXTERNAL CLEANING	60			
5.1.1 Cleaning the display	60			
5.1.2 Cleaning of				
chrome-plated surfaces	60			
5.1.3 Cleaning of				
machine surfaces	60			
5.1.4 Cleaning of solid/liquid				
grounds container	61			
5.1.5 Cleaning of instant products/				
coffee bean containers	61			
5.2 CLEANING OF FUNCTIONAL				
UNITS	63			
5.2.1 Cleaning mode access	63			
5.2.2 All in One cleaning	64			
5.2.3 Semi-automatic cleaning of the				
Espresso/CARIBrew group ..	68			
5.2.4 LIGHT cleaning of the				
Espresso/CARIBrew group ..	70			
5.2.5 Manual cleaning of the				
Espresso group	71			
5.2.6 Mixer automatic cleaning	74			

5.2.7	Disassembly and manual cleaning of the instant products Mixer	74
5.2.8	EVO Milker circuit cleaning ..	76
5.2.9	Disassembly and manual cleaning of EVO Milker	78
5.2.10	Water tank cleaning	79
6	TROUBLESHOOTING	80
6.1	ESPRESSO GROUP ERRORS ..	81
6.2	GENERAL ERRORS	81
7	DECOMMISSIONING AND DISPOSAL	83

GENERAL SAFETY WARNINGS

This manual is an integral part of the machine.

Read carefully the instructions and warnings contained in this manual since it provides important indications concerning the installation, use, and maintenance of the appliance.

For specific warnings concerning the positioning, installation, power and hydraulic connection, and the machine use and maintenance, refer to the related paragraphs in this manual.

The machine is intended for professional use. Always strictly follow the instructions contained in this manual and keep it in a safe, dry place for future reference.

The machine must be used by skilled operators according to the instructions provided in this manual. Any other use is considered as improper.

The weighted, equivalent sound pressure level is below 70 dB.

After having unpacked the machine, verify its integrity. In case of damage or doubts about the packaging contents, please contact the Carimali Service Centre.

Handle the machine with care to prevent the risk of impacts or falls that may cause damage.

In case of damage suffered in the premises due to accidental nature, wilfully, etc., the putting back into service must be carried out by qualified persons or out Carimali Service Centre.

WARNING



In order to ensure the safety of the operator and the machine, it is strictly forbidden to use the machine in a different manner from that indicated in this manual.

WARNING



The Manufacturer declines any liability for damage to things and/or persons arising from an improper use of the machine and/or an incorrect maintenance.

WARNING



If residues of inedible material are found inside beverages during machine use, it is necessary to carry out maintenance.

Keep packaging parts (box, inner protections, etc.) out of reach of children since they are potentially dangerous. Do not dump those parts into the environment, but dispose them according to applicable regulations.

NOTE

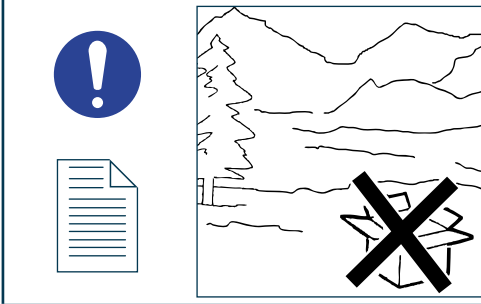

This symbol on the product or on the packaging indicates that the product shall not be treated as household waste, as it shall be delivered to an authorised waste collection point for recycling of electric and electronic devices.



For more detailed information about recycling of this product, contact the

local authority, the local waste disposal service.

The equipment is not suitable for the installation in close proximity of water jets or heat sources. Avoid the direct contact with water jets or other liquids also during cleaning.

Do not expose the machine to weather conditions (sun, rain, etc.).

Unplug the machine for any intervention of routine maintenance or checking.

WARNING



Do not pull the power cord to unplug the machine from the electric socket.

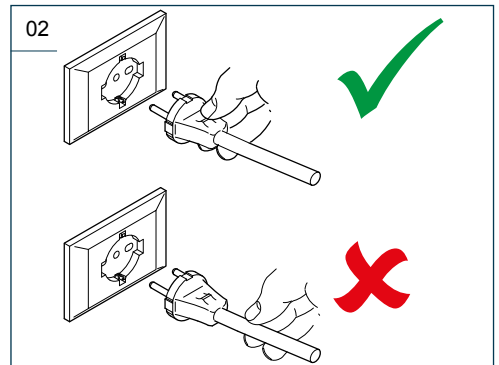

In case of power cord damage, have it replaced by the Manufacturer, his authorized technical Service Centre or skilled personnel to prevent any risk.

The machine can be used by children aged from 8 years and above and persons with reduced physical, sensory or mental capabilities or lack of experience and knowledge if they have been given supervision or instruction concerning use of the appliance in a safe way and understand the hazards involved. Children are not allowed to play with the device and to carry out cleaning and maintenance operations without the supervision of trained personnel.

Never touch the hot parts of the machine.

Never touch the machine when hands or other body parts are wet.

Never immerse the machine in water.

The machine delivers high-temperature drinks. Beware of scalding that can be caused by accidental contact with the hot water wand while using the machine.

In case of fault or malfunctioning of the machine, switch it off, unplug it and contact the Carimali Service Centre.

In case of fault or malfunctioning of the machine, switch it off and unplug.

Access to the service areas is restricted to those persons with the relevant practical experience, especially in terms of safety and hygiene.

For repairing, contact only a Service Centre authorised by the Manufacturer and require the use of original spare parts and accessories. Failure

to comply with the above regulations could jeopardise machine safety.

For any communication regarding failures or malfunctioning, contact the nearest Service Centre, indicating the model, the type and the serial number of the machine. The data are shown on the opposite data plate.

In case the machine is not used any longer, empty the boilers and render it inoperative.

WARNING



If the machine is idle for any period, before putting it back in service, carry out the necessary maintenance operations to allow it to return to work in optimum condition.

NOTE

When required and in case of operations not described in this manual, contact the nearest Service Centre or the Manufacturer.

NOTE

The latest version of the manual can be accessed by registering in the area reserved to customers of the official Carimali website.

The Manufacturer reserves the right to carry out technical and aesthetic modifications to the machine and/or this manual for manufacturing or sales reasons without obligation to update the previous versions.

Owing to the above, some pictures contained in this manual may slightly differ from the actual product.

NOTE

The appliance must be installed only in places where it can be checked by skilled personnel.

WARNING

In case of faults caused by the failure to follow the above, the Manufacturer declines any liability for damage caused by non-compliance with the aforesaid provisions.

HANDLING AND STORAGE

WARNING

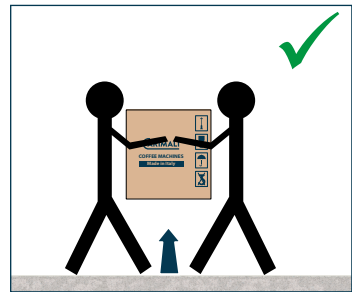
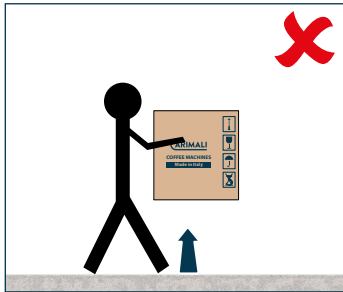

NOTE



Handle the packaging by means of the opposite carrying handles.

WARNING

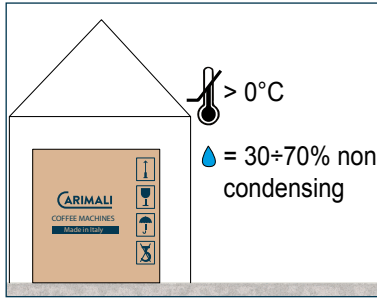

In case of prolonged storage at temperatures below 2°C, the water circuit in the machine must be drained by the Customer. Do not switch the machine on before having reconditioned it for at least 1 hour at a suitable room temperature. If it is installed in areas with room temperature above 30 °C, malfunctioning may occur.

WARNING



Should you decide not to use the machine any longer, unplug it and then make it inoperative by cutting off the power cord.

NOTE



The disposal of the machine is not responsibility of the Manufacturer and must be carry out in compliance with the applicable regulations.

WARNING



Follow the aforesaid disposal procedures, subject to penalties set forth in the applicable waste legislation.

03

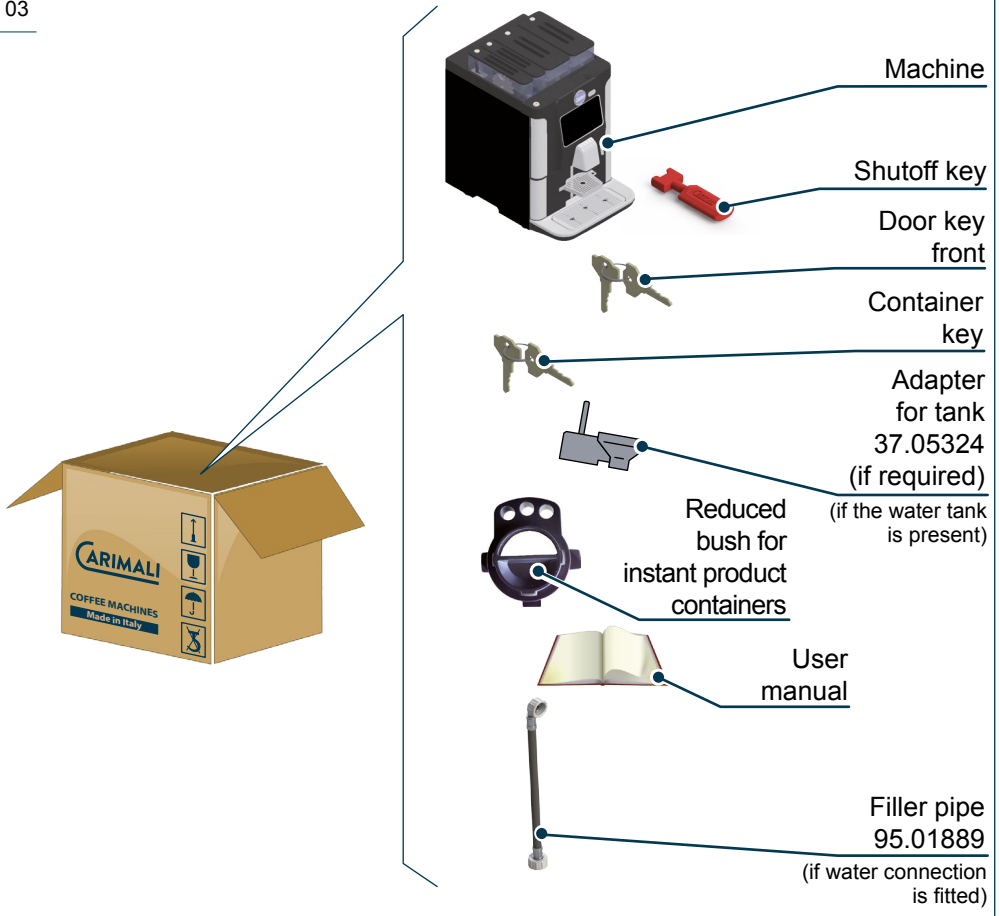

PRIOR CHECKING AFTER RECEIPT

Check the integrity of:

- External and internal packaging;
- External and internal machine parts;
- Accessories supplied.

NOTE



In case damages or anomalies of the supply are noticed, contact the Manufacturer within 7 days from the purchase.

POSITIONING

Position the machine:

- Indoor with temperature ranging from 5° and 30°C.
- At a minimum distance of 50 mm from walls or other objects, to facilitate ventilation.
- Horizontally, on a flat, stable surface, at a minimum height above 700 mm and below 960 mm.

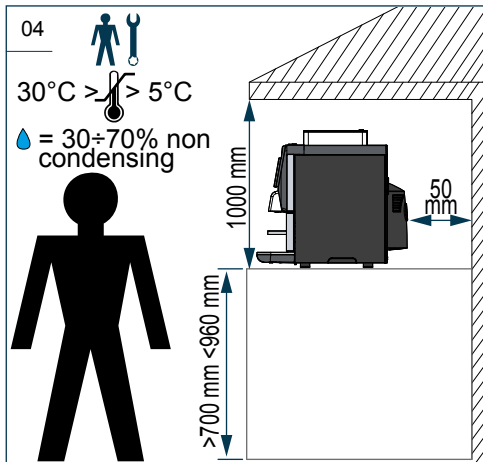

WARNING



Position the machine on a horizontal surface.

NOTE



The machine with raised containers cannot be installed on a surface under a wall unit, due to the increased dimensions.

WARNING



Do not obstruct the openings or slots for ventilation or heat dissipation and do not insert water or any kind of liquid.

WARNING



The consents and the procedures described below must be performed by a skilled technician.

CONNECTION TO THE POWER MAINS

DANGER



Do not carry out this operation with wet or damp hands.

ATTENTION



Before plugging the machine in, make sure the power switch is on "0" position and the plate data match with the ones of the electrical mains.

ATTENTION



For electric safety of the machine, it is necessary to provide a grounding system complete with a residual current circuit breaker (max IDN = 30mA).

WARNING



The Manufacturer declines any liability for failure to comply with the above or for damages caused by the failure to properly ground.

WARNING



Do not connect the terminal to the power distribution system as the power cord protection conductor is not considered an equipotential bonding conductor.

05

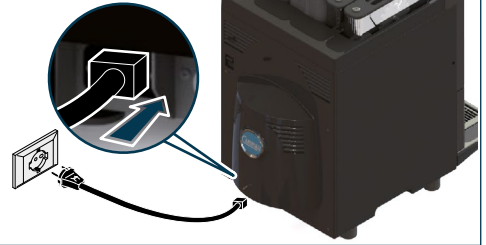

Unroll the power cord for its entire length to prevent the risk of dangerous overheating.

NOTE



Make sure the connector is properly inserted into the appropriate machine socket.

WARNING



The connection to power mains must be done by a skilled technician in compliance with applicable regulations. Use the certified Carimali power cord.

WATER MAINS CONNECTION

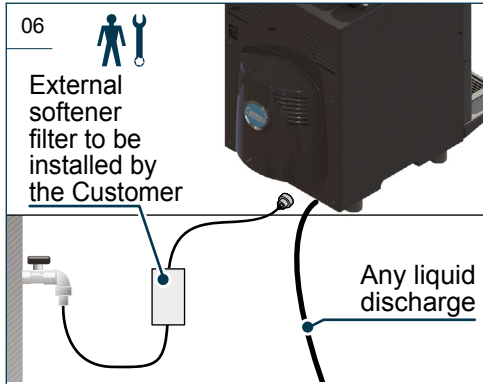

ATTENTION



Never use the machine without water.

ATTENTION



In case of machine version JOLLY, the passage of the water mains to the tank must be carried out by an authorized technician.

NOTE



If the data plate shows the letter "J", the machine is version JOLLY (water mains + tank). If it is missing, the machine has no connection to the water mains, but is only equipped with the tank.

ATTENTION



The mains water pressure must never exceed 6 bar (0.6 MPa); if this is not the case, a qualified technician must fit a pressure reducer.

ATTENTION



For water mains connection, use only the hose and the fittings supplied with the device.
Do not utilize used parts.

WARNING



For the proper use of the machine, install an external softener filter in case of water connection or use the apposite filter CARIMALI (with adapter, if required) on the machine equipped with tank.

WARNING



If your version envisages the connection to the water mains, it must be performed by a skilled technician in compliance with the applicable standards. To prevent damages to the hydraulic system, the optimal range of the water inlet from the mains must be between 7 and 10 French Degrees.

MILK CIRCUIT CONNECTION

WARNING



Milk temperature must be below 4 °C.

Connect the milk container to the EVO Milker outlet hose.

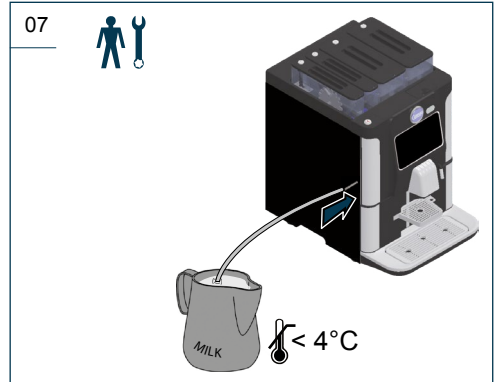

If an additional unit is fitted, connect the EVO Milker outlet to the unit.



09



Predisposition hole
milk tube inlet

NOTE



The fridge was designed and built to work along with the machine, in order to ensure a correct conservation of milk at a suitable temperature. For further details about the use and maintenance of the fridge, refer to the specific documentation.

Tank filling

If the machine is equipped with the tank, remove it from the machine when it is to be filled or for any other checking operation.

ATTENTION



Never use the machine without water.

WARNING



To fill the tank or from the connection to the water mains, use water suitable for human consumption according to applicable standards.

WARNING



The optimal range of the water inlet from the mains must be between 7 and 10 French Degrees.

ATTENTION



This operation must be performed by a qualified service engineer during the machine installation process and according to the instructions in the Maintenance Manual.

NOTE



Carry out this operation only when installing the machine. In the next starts, the machine will carry out these operations automatically.

RESIDUAL RISKS

The Manufacturer pre-sets all necessary measures to ensure operator's safety when using the machine.

Anyway, some inconveniences may occur in certain conditions and/or situations.

The causes may be:

- Operator not suitably trained and/or experienced.
- Machine misuse.
- Use of foodstuffs close to their expiry date or already expired.
- Use of non-certified foodstuffs.
- Use of non-original spare parts.
- Unauthorized modifications on the machine.
- Improper maintenance of the machine.

IDENTIFICATION

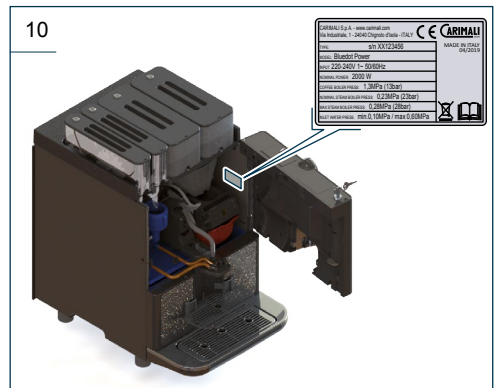

1 INTRODUCTION

1.2 USER TYPES

This manual is a basic component for the use of the machine. It contains instructions and information about handling and usage of the machine in safety.

1.1 SYMBOLS

DANGER



This indicates a serious danger for the operator that may cause severe injury or death.

ATTENTION



This indicates a potentially dangerous situation for the operator that may cause severe injury.

WARNING







This indicates a potentially dangerous situation that may cause minor injury or machine damage.



NOTE



This points out notes or operation procedures that helps the operator when using the machine.

ICON	DESCRIPTION
	USER User in charge only of the simple use of the machine.
	FILLING AND MAINTENANCE OPERATOR User in charge of the filling/emptying of products and consumables, as well as routine maintenance.
	QUALIFIED TECHNICIAN Skilled operator in charge of installation, adjustment, advanced use, and routine maintenance.
	CARIMALI TECHNICIAN Skilled operator authorized by the Manufacturer, in charge of complex operations.

ATTENTION

Only the **CARIMALI TECHNICIAN** or a **SKILLED TECHNICIAN** have a shutoff key, which allows the access to moving parts or hot parts.
Be very careful during the maintenance or repairing procedures.



1.3 INTENDED USE

The machine was designed and manufactured for dispensing hot drinks, such as:

- Coffee;
- Instant products;
- Tea;
- Milk.

The machine is intended for professional use, such as:

- Refreshment areas in shops;
- Refreshment areas in offices;
- Refreshment areas in other environments;
- Holiday farms;
- Hotels;
- Motels;
- Bed & Breakfast.

1.3.1 Reasonably foreseeable misuse

WARNING



In order to ensure safety of the operator and the machine, it is strictly forbidden to use the machine in a different manner from that indicated in this manual.

ATTENTION



The machine is not intended for outdoor use.

2 DESCRIPTION OF THE MACHINE

2.1 MACHINE CONFIGURATIONS

Brewer	Fresh Milk	G	S	X	Water supply
E	0M	1G	0S	0X	WT - WM - WJ
E	0M	1G	2S	2X	WT - WM - WJ
E	0M	2G	2S	2X	WT - WM - WJ
E	1M	2G	0S	0X	WT - WM - WJ
E	1M	1G	2S	2X	WT - WM - WJ
E	1M	2G	2S	2X	WT - WM - WJ
E	1M	1G	3S	2X	WT - WM - WJ
E	0M	1G	3S	2X	WT - WM - WJ

Key:

E: Espresso brewer

M: MILK

S: Instant products / Tea containers

G: Coffee grinder

X: Mixer

WT: Water tank

WM: Water connection

WJ: Jolly water supply

Optional:

- Water supply connections
- Jolly water supply (tank + water connection)
- 100 l CariPure water filter
- Premium grinder set
- Premium Self (Cup station)
- Sensor of presence and cup size
- MaxSave energy savings
- Aroma fan
- Liquid grounds direct discharge
- Solid grounds direct discharge
- GSM modem
- RFID
- Wi-Fi
- Cash and cashless payment system
- Raised product containers

Additional units:

- Fridge with digital temperature
- Cup warmer

2.2 OUTER COMPONENTS

11

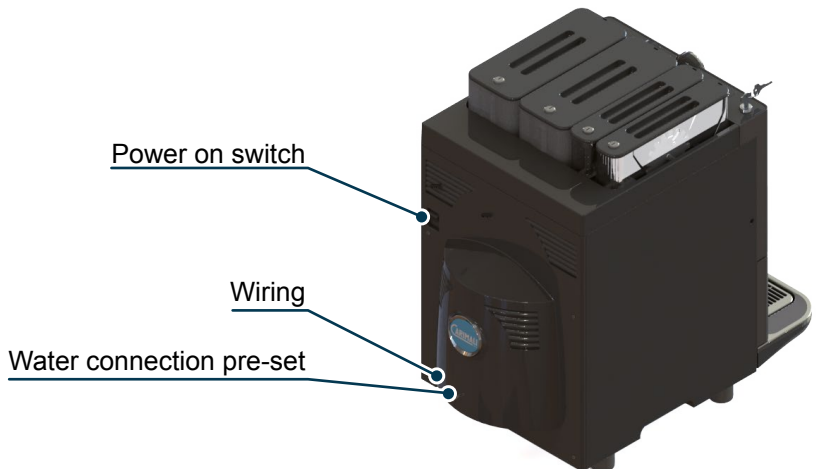
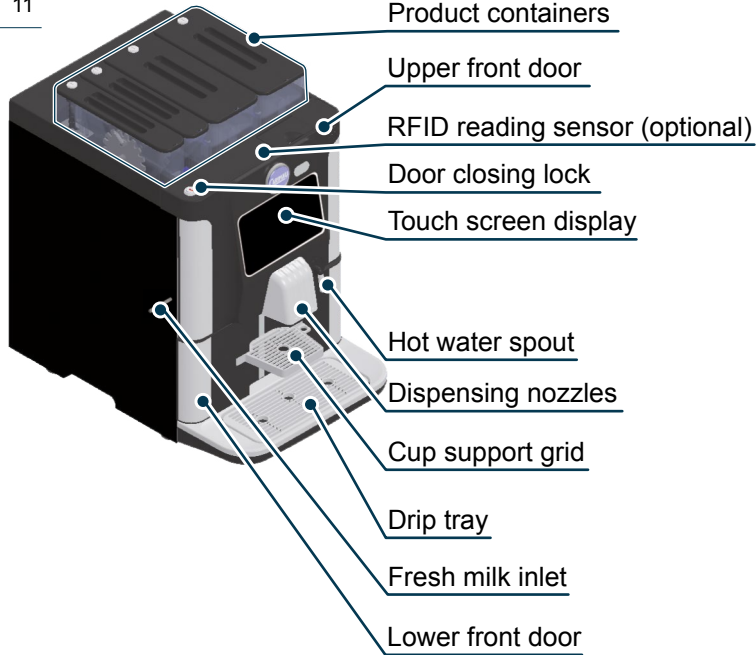

2.3 INNER COMPONENTS

NOTE



The machine can be set up (modular) according to customer's requirements. The main components are listed below.

NOTE



All configurations described here below can have more or fewer parts and optional extras installed (container number, raised containers, aroma fan, etc.) according to customer requirements.

12 Version Espresso "E" + instant products (Standard Espresso group)

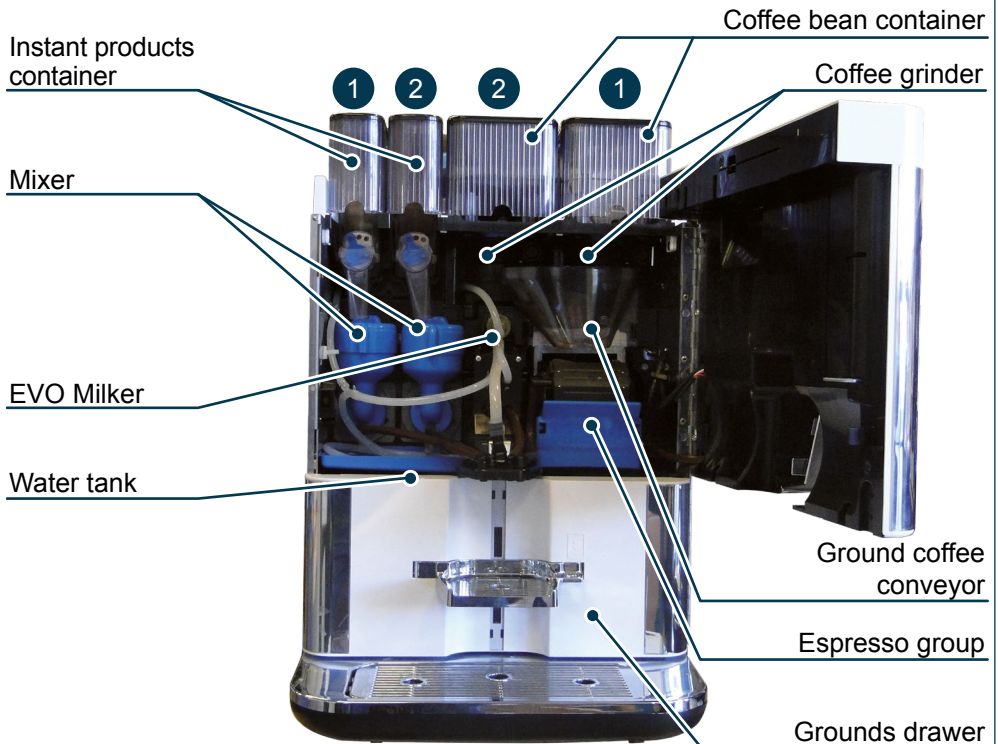

13 Version Espresso "E" + instant products (CARIBrew Espresso group)

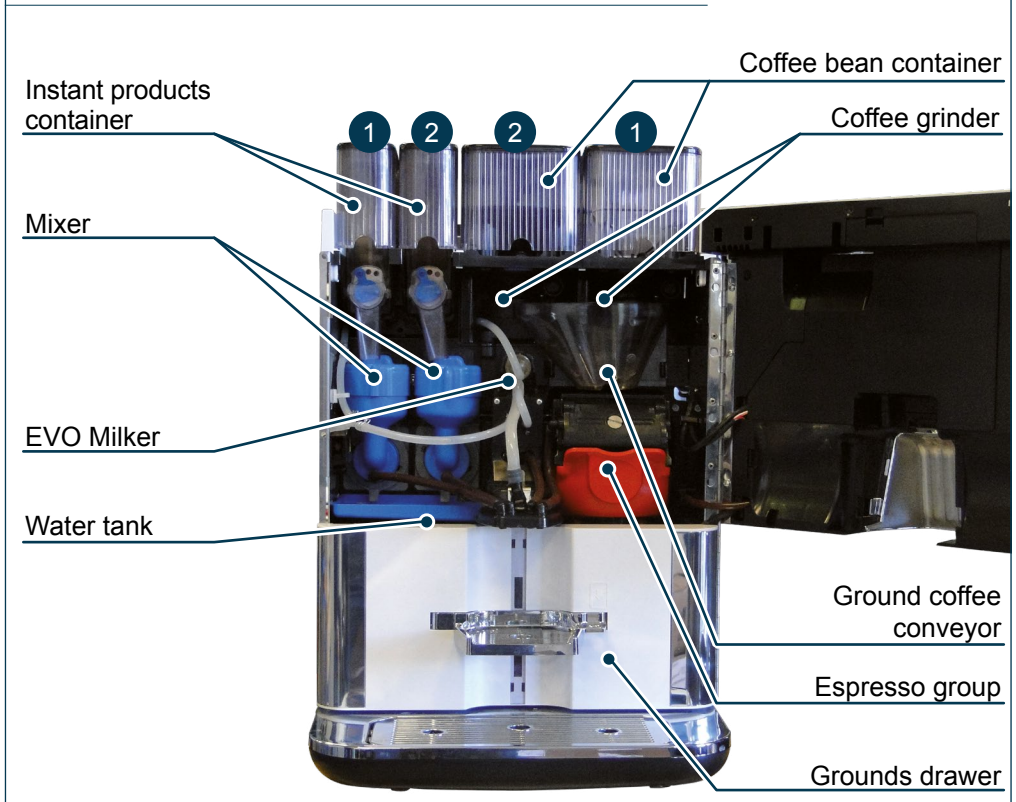

2.3.1 Product containers

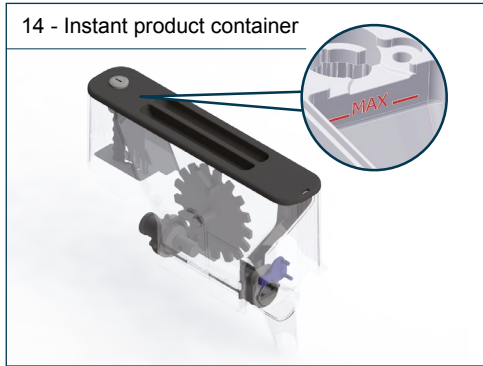

Container capacity:

- Standard: 0.8 litres
- Raised: 1.8 litres

WARNING



When the container is filled with the product, close the lock protection; open it after filling.

WARNING



When the container is filled with the product, close the lock protection; open it after filling.

NOTE



Never fill the containers above the max. level indicated.

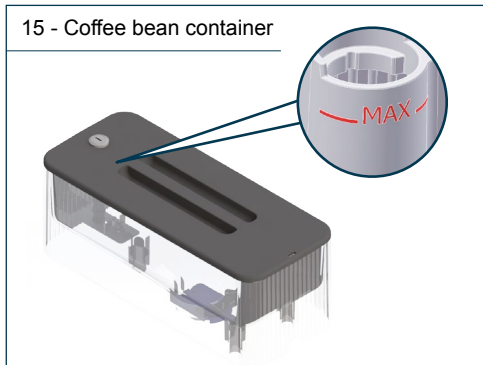

Container capacity:

- Standard: 0.6 kg / 1.8 litres
- Raised: 1.2 kg / 3.5 litres

2.3.2 Reduced bush for containers

Replace the standard bush with the supplied reduced one (Code 37.05443) in the following cases:

- Machine with instant product containers where the topping is used instead of the powder;
- Machine in tea configuration where a tea blend with small minced leaves is used.



2.4 TOUCH SCREEN DISPLAY

2.4.1 Display use



2.4.2 Home page - Power on

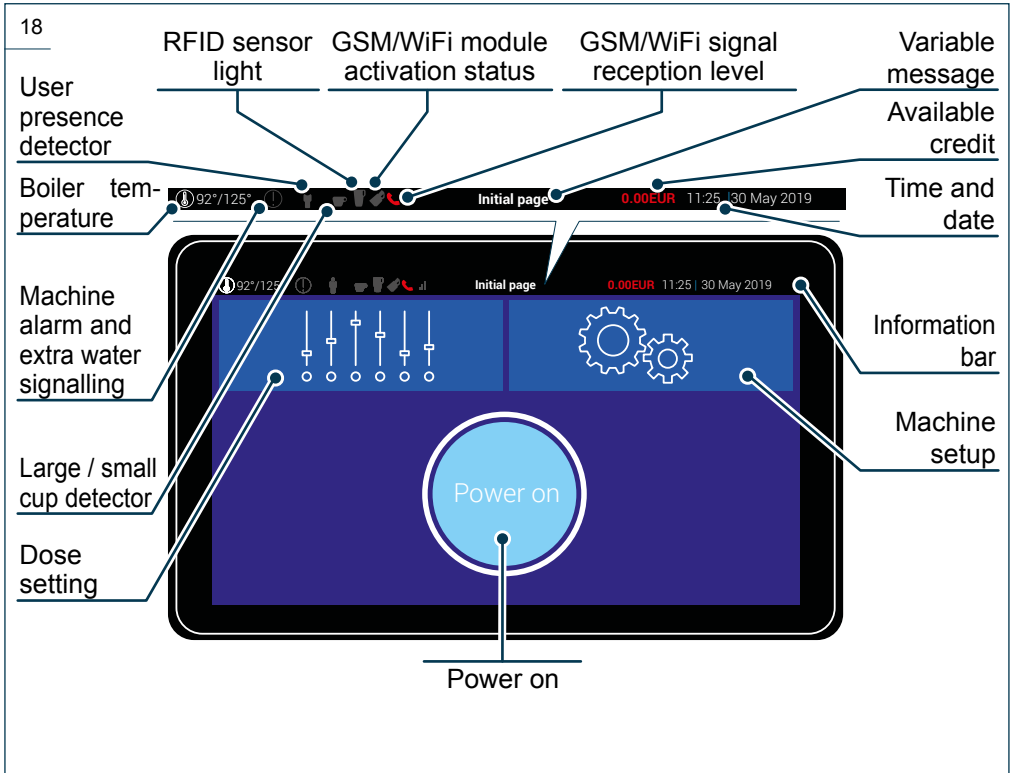

NOTE



If the coffee or steam boiler has not reached the correct working temperature, the heating page will be shown when “Power on” is pressed.

NOTE



The info bar icons described refer to the machine with all optional extras. If your machine does not have all of the optional extras, some of the icons will not be shown on the display.

2.4.3 Heating waiting screen (Boiler-Steam)

19

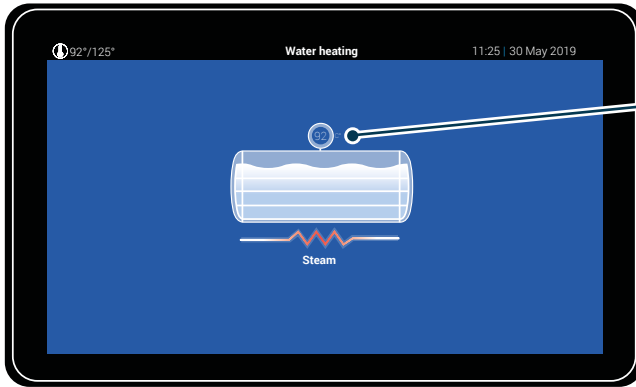

Temperature display

NOTE



The page is visualized when switching the machine on or anytime the boiler temperature goes below the minimum drink dispensing temperature.

NOTE



The heating of the steam boiler begins after the one of the coffee boiler.

2.4.4 Introduction

20



Introductory video

2.4.5 Selection of drinks to be dispensed (example of free vend drinks)

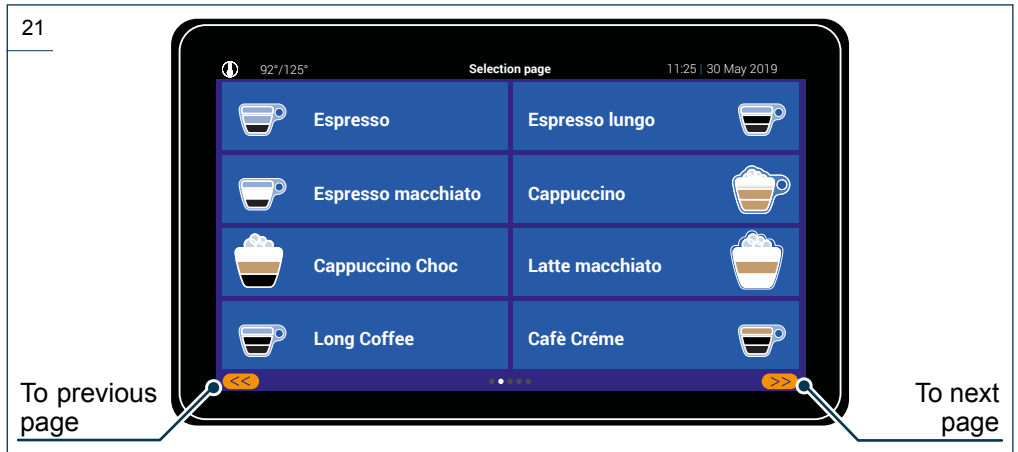

NOTE



Press the required drink to proceed with dispensing.

NOTE



This page can change according to the number of drinks set in the machine parameters (access allowed only to the Skilled Technician).

2.4.6 Hot water dispensing

22

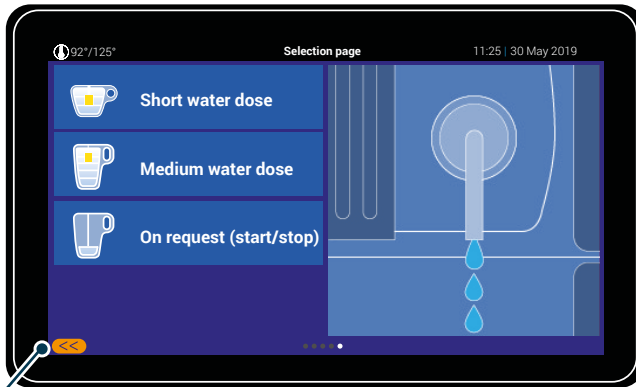

To previous page

NOTE



This page is at the end of the selection pages of the drinks to be dispensed, regardless of the number of active drinks.

2.4.7 Dispensing in process

23

Selected drink memo

Dispensing progress bar

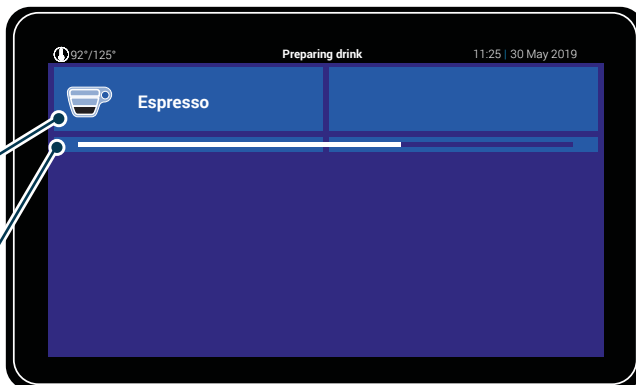

2.4.8 Delivery completed

24

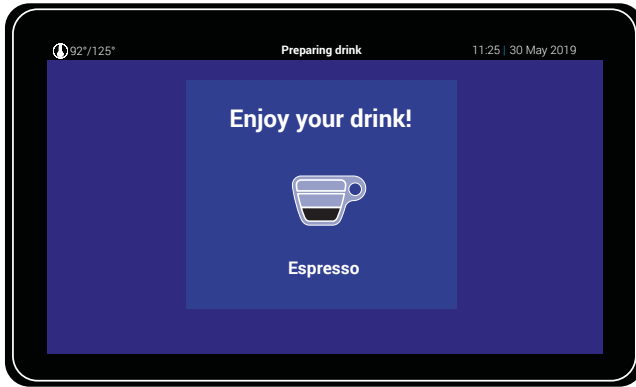

At the end of dispensing, an acoustic alarm signals that the machine completed its cycle and is ready for a new dispensing.

2.4.9 Setup menu - Recipe setting (examples of drinks)

NOTE



Minimum access level.



From the “Home page” screen, press the “Dose setting” key to enter the product screen with yellow labels showing the possibility of modify the recipes.

25 - Drink setting page



To main page

To next page



: This symbol signals that the drink dispensing is disabled.

26 - Selection page of settings to modify

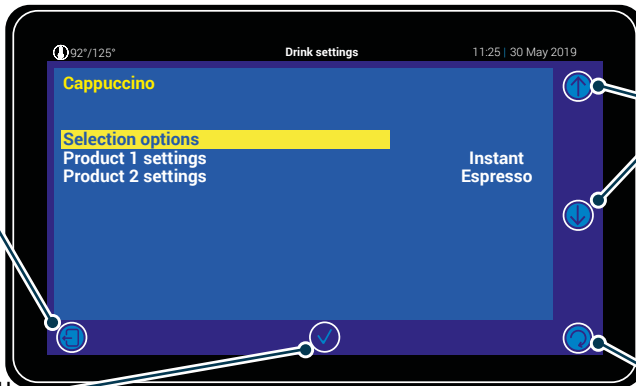

To Home page

List scrolling

Press to access the selected menu

To previous page

27 - General setting page

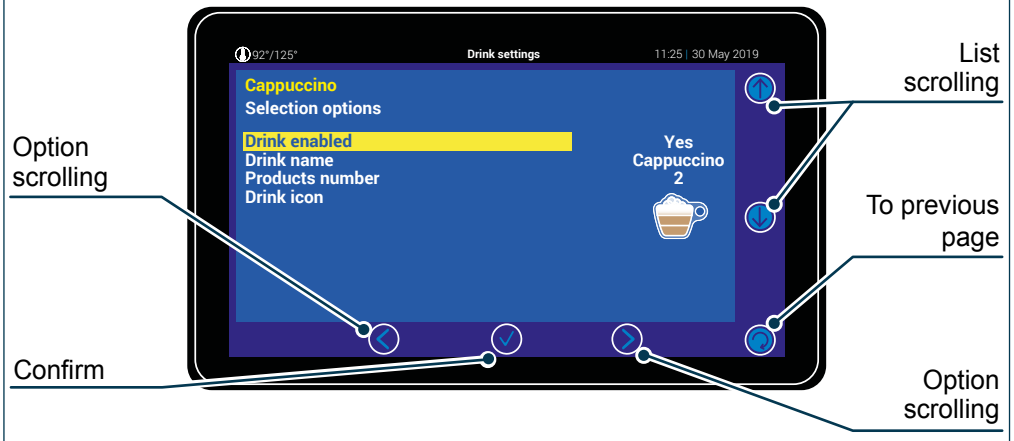

According to setting of the parameter “product number”, the menus “product composition” and “product settings” will vary.

28 - Product composition page

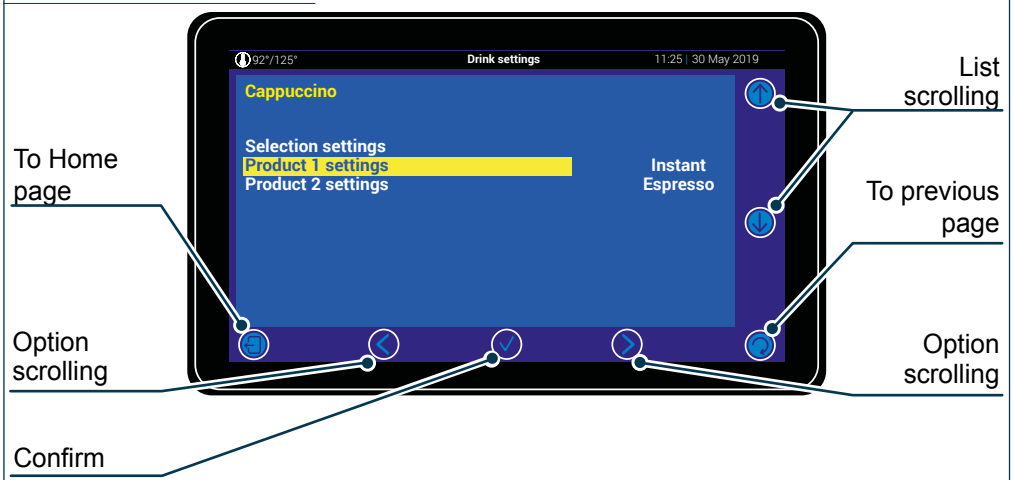

The composition of the available drinks, according to the machine configuration, are listed below:

- Espresso
- Instant product
- Milk
- Hot water

Each drink composition defines the type and the parameters to set in the menu “Product setting #”.

29 - Product setting page

Selected product

To Home page

Go to modification

Drink settings

11:25 | 30 May 2019

Settable parameters

List scrolling

To previous page

Parameter #	Value
Parameter #1	XXXXXXXXXX
Parameter #2	XXXXXXXXXX
Parameter #3	XXXXXXXXXX
Parameter #4	XXXXXXXXXX
Parameter #5	XXXXXXXXXX
Parameter #6	XXXXXXXXXX
Parameter #7	XXXXXXXXXX
Parameter #8	XXXXXXXXXX
Parameter #9	XXXXXXXXXX
Parameter #10	XXXXXXXXXX

NOTE



This page allows to modify the composition of the drink by modifying the parameters.

SETTABLE PARAMETERS:

Comp. beverage	Element	Min. value	Max. value	Unit of measure	Other /Notes
ESPRESSO	Origin				Grinder 1 Grinder 2 Decaf Grinder 1 and 2
	Delayed start time	0	300	Tenths of a second	
	Grinding time	0	150	Tenths of a second	
	Water dose pulses	0	500	No.	
	Empty coffee chamber	249	251	No.	
	Water adding pulses	0	400	No.	
	Pre-infusion time setting	0	50	Tenths of a second	
	Pre-infusion pause setting	0	150	Tenths of a second	
INSTANT PRODUCT	Origin				Instant product motor 1 Instant product motor 2 Instant product motor 3
	Delayed start time	0	300	Tenths of a second	
	Water dispensing delayed start	0	350	Tenths of a second	
	Mixer motor time ON	0	370	Tenths of a second	
	Mixer motor delayed start	0	350	Tenths of a second	
	Instant product motor time ON	0	350	Tenths of a second	
	Instant product motor delayed start	5	350	Tenths of a second	
	Mixer speed setting	0	2	No.	0 maximum speed 1 medium speed 2 min. speed
Instant product dispensing steps	0	2	No.	0 dispensing without interruption 1 a pause during dispensing 2 two pauses during delivery	

Comp. beverage	Element	Min. value	Max. value	Unit of measure	Other /Notes
MILK	Delayed start time	0	300	Tenths of a second	
	Steam dispensing time	0	200	Tenths of a second	
	Milk frother delay	10	160	Tenths of a second	
	Milk frother air time	0	200	Tenths of a second	
	Steam delay	15	25	Tenths of a second	
	Pump time forward	0	300	Tenths of a second	
	Pump speed forward	20	60	Percentage	Value that can be set for 1% step according to the max. speed of the pump with limits from 20% to 60%.
HOT WATER	Delayed start time	0	300	Tenths of a second	
	Dispensing time	0	350	Tenths of a second	

2.5 DISPLAY VERSIONS

2.5.1 Cup station

NOTE



If the “Cup Station” option is enabled, every time delivery of a drink is selected, the system checks the closing state of the front door.

NOTE



The version with “Cup Station” features one only front door. Open the door with the key for emptying the drawer of used grounds. After emptying, when closing the front door, confirm the drawer emptying on the display.

If the door is open, the display shows the following page of door closing request.

30

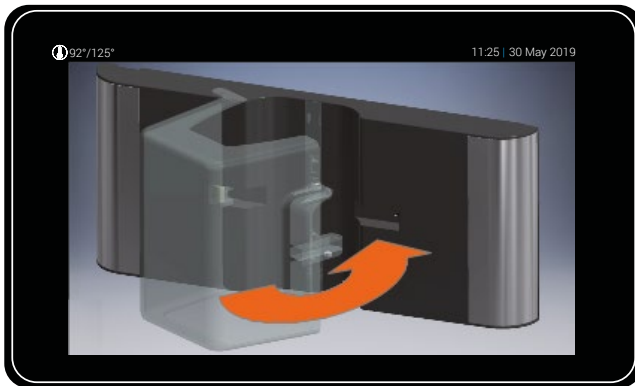

NOTE



If the “Door Locked” function is active, the front door cannot be split between top and bottom, but it is a single piece and to open it, the lock must be released.

Once having closed the front door, the dispensing starts automatically.

31

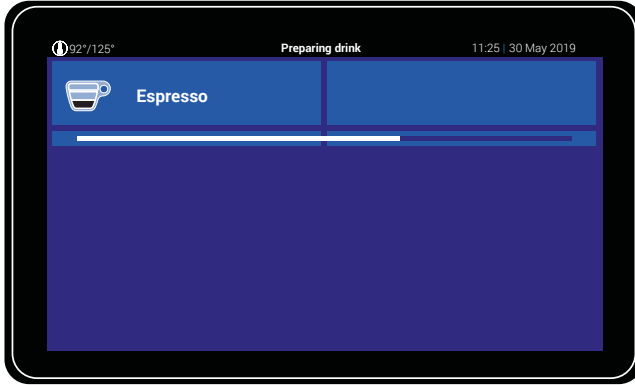

NOTE



During delivery, the door cannot be opened and will remain locked until the end of the process.

Subsequently, the end of delivery page is visualized.
The door can be opened and the beverage taken out.

32

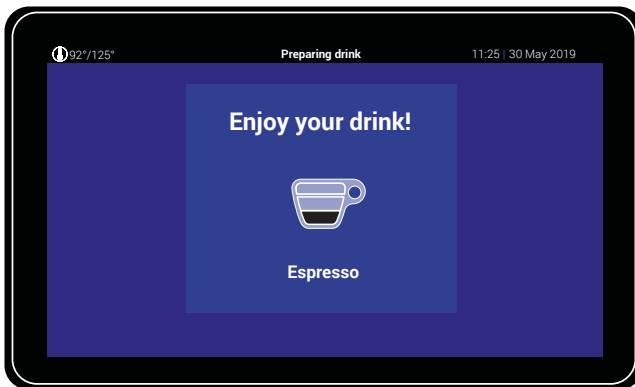

2.5.2 “YES” option

When the coffee grounds drawer is full, the machine will show:

33



Open the upper front door, which will be one single piece.

34

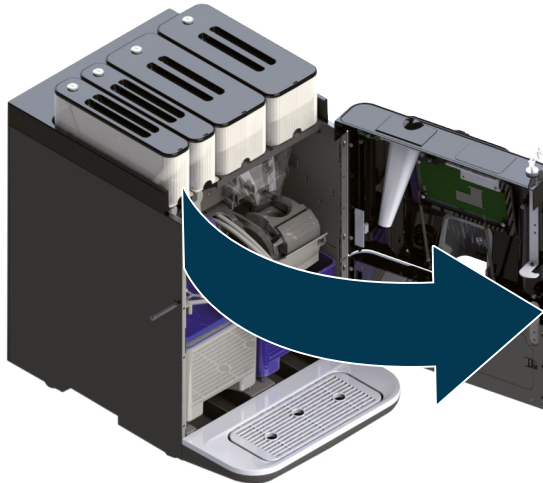

NOTE



The machine will switch off automatically and will restart when the front door is closed.

Remove the grounds drawer and empty out the coffee grounds.
Refit the grounds drawer and close the front door again.

35

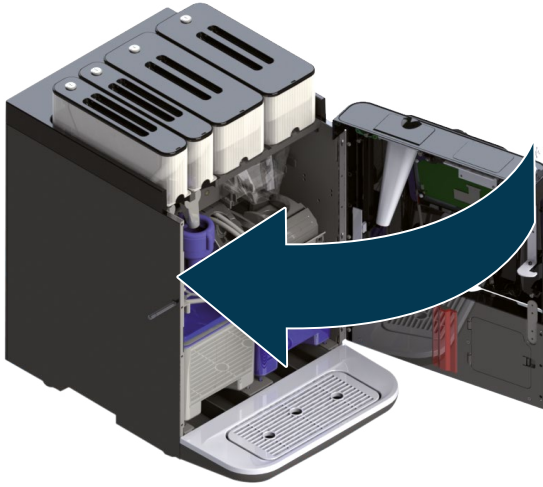

The machine will restart, showing the “Home page” screen.

36

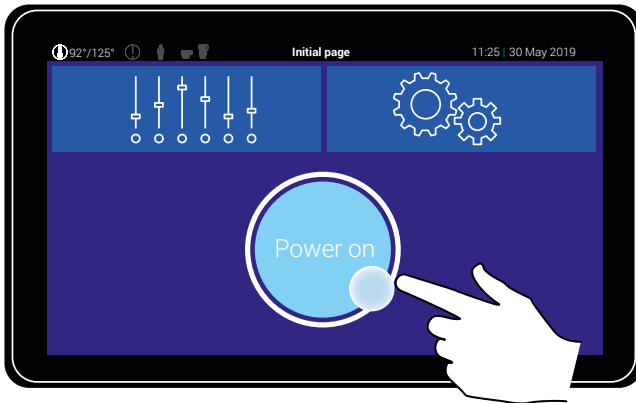

37

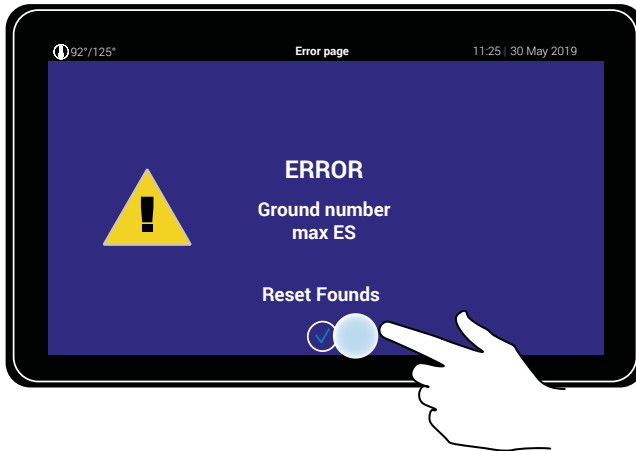

The emptying of the ground coffee is confirmed and the ground container is reset.

2.5.3 “YES+?” option

Regardless of the coffee grounds drawer being full, when “Power on” is pressed, the machine will ask if the drawers have been emptied.

38

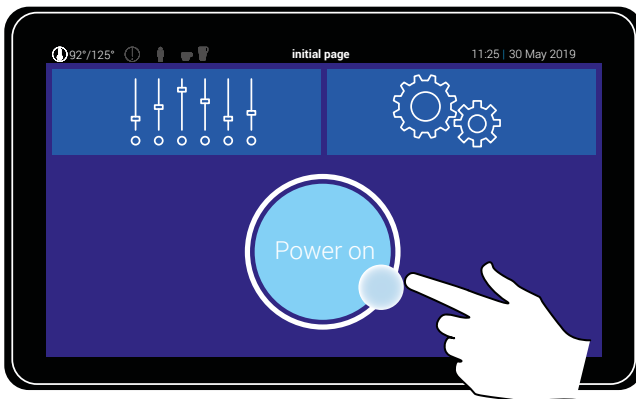

39

Press to start the machine without resetting the coffee ground counter.

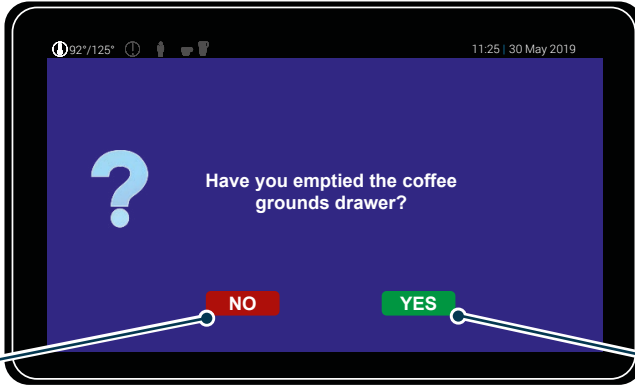

Press to confirm the emptying of the ground coffee. The coffee grounds counter will be reset

If emptying is confirmed, the display shows the following page.

40

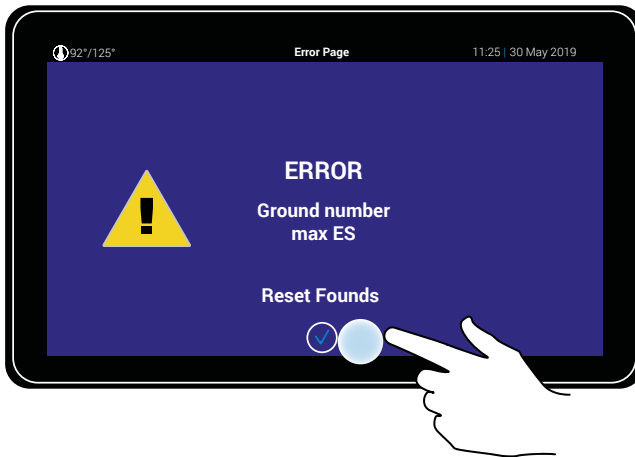

The emptying of the ground coffee is confirmed and the ground container is reset.

2.5.4 Cup height/presence sensor

NOTE



If the “Height / presence cup” option is enabled and the beverage recipe has been set for the types of cup suited to the delivery, each type the beverage delivery is selected, the system will check for the presence of a suitable cup on the cup sensor.

SENSOR	DISPLAY	OPERATION
Low		<p>It enables dispensing if a small cup is placed in correspondence of the low sensor.</p>
High		<p>It enables dispensing if a small cup is placed in correspondence of the high sensor or, when there is no cup protection door, if a small cup is positioned on the cup holder, in correspondence of the high sensor.</p>
Jolly		<p>It enables dispensing if a cup (big or small) is placed in correspondence of one of the two sensors (high or low).</p>

NOTE



When the user does not position the correct cup, the drink will not be dispensed.

Once having positioned the correct cup, the machine will proceed with the drink dispensing.

41

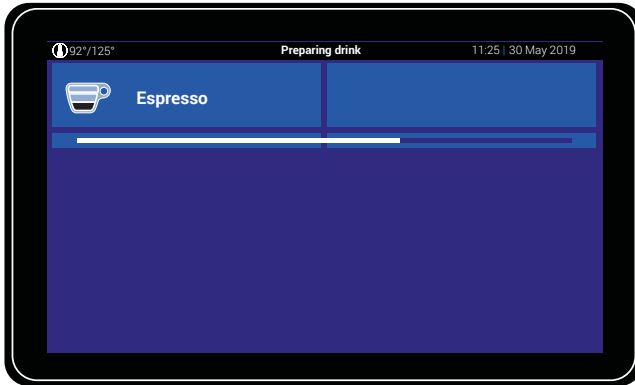

After dispensing, the following page is shown.

42

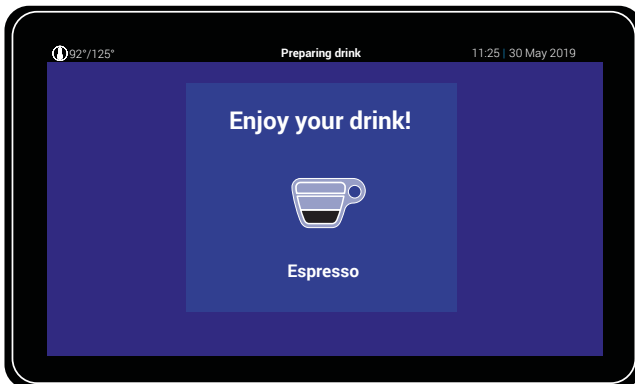

The drink can be taken out.

2.5.5 Energy save

NOTE



Technical access level.



NOTE



When the energy saving option is enabled, it will be applied only with the machine on. The software will activate the energy saving mode according to five conditions:

- User's presence, if no user is detected.
- Cup presence, if no cup is detected.
- Timeout timer based on a "time" setting.
- No drink dispensing.
- No button pressure.

In all these conditions are present, the machine enters the "Energy Save" mode and a screensaver will appear on the display.

43



When one of the above condition is valid no longer, the system disable the "Energy Save" mode, resetting the working temperature according to the machine settings.

2.5.6 Light dose view

NOTE



Technical access level.



44

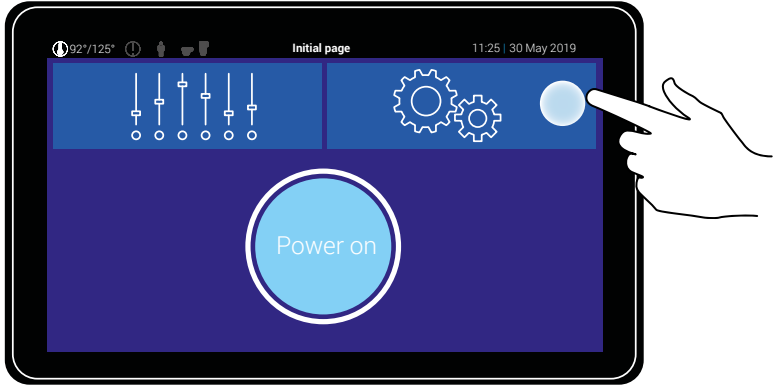

45

Menu Dose
counters

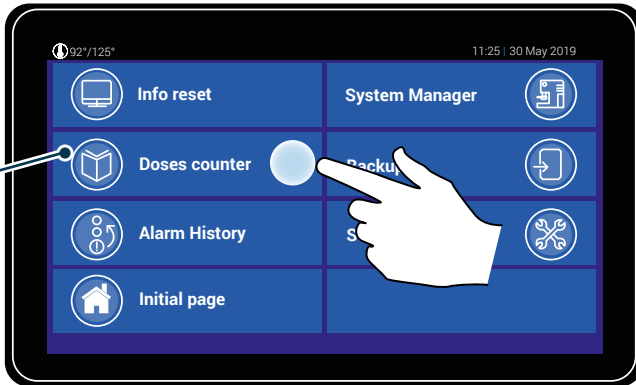

46

Total counter of the drinks dispensed

Partial counter of the drinks dispensed

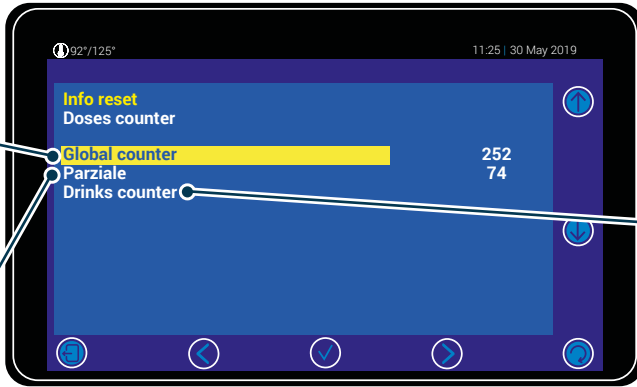

Detailed counter of the dispensed drinks

Accessing the detailed counter of the dispensed drinks, a screen can be view where the number of dispensing is shown next to each drink.

47

To previous page

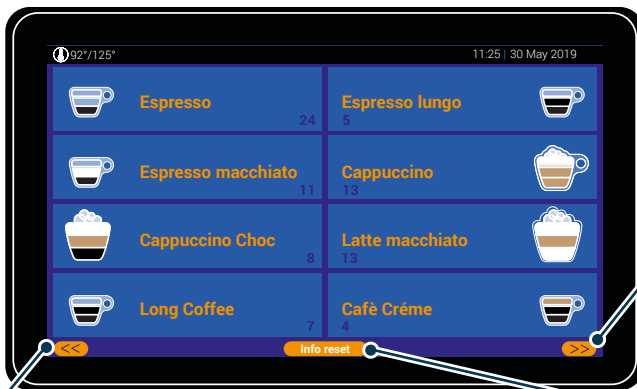

To next page

Press to exit the menu

2.5.7 Manual delivery stop

NOTE



If the “Stop Dispensing” function is enabled, the user has the possibility to stop delivery manually.

48

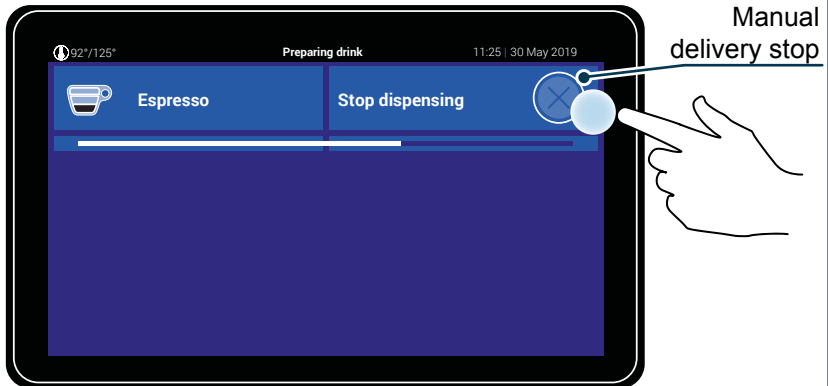

NOTE



The manual delivery stop is not instant, but occurs when the system detects a safe situation for machine operation.

WARNING



If there is an MDB payment module, the necessary credit for delivery is subtracted in full, even if delivery is interrupted before completion.

2.5.8 RFID - Replacement of Filter CariPure100

NOTE



This function is only present if the RFID reading sensor (optional) is installed.

NOTE



If this function is present, the machine will automatically signal when it is time to replace the filter at the end of its useful life.

When purchasing the CariPure100 filter, move the filter package, where

the symbol  is present, to the top part of the machine.

49



When the machine detects the filter (if compatible) it will show the following screen:

50

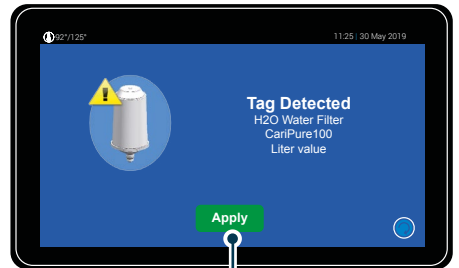

Confirms the filter identification

Confirming the request, it is possible to proceed to install the new filter.

WARNING



On confirmation, the filter use counter will be reset.

WARNING



If the filter is not compatible, the display will show the following screen and it will not be possible to proceed with installation.

51

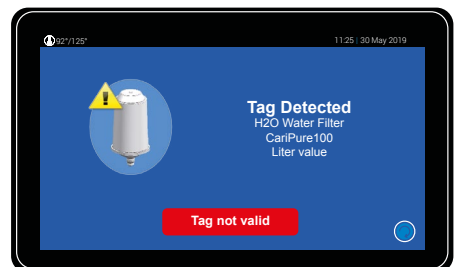

2.5.9 MDB payment system

NOTE



If the MDB payment system is installed and enabled, it is necessary to insert the required money to delivery the beverage.

WARNING



Beverage management can be managed from software (technician) and it is different according to the type of MDB installed.

NOTE



To set the price of each single beverage, it is necessary to access the selection option and then to select the price filed.

52

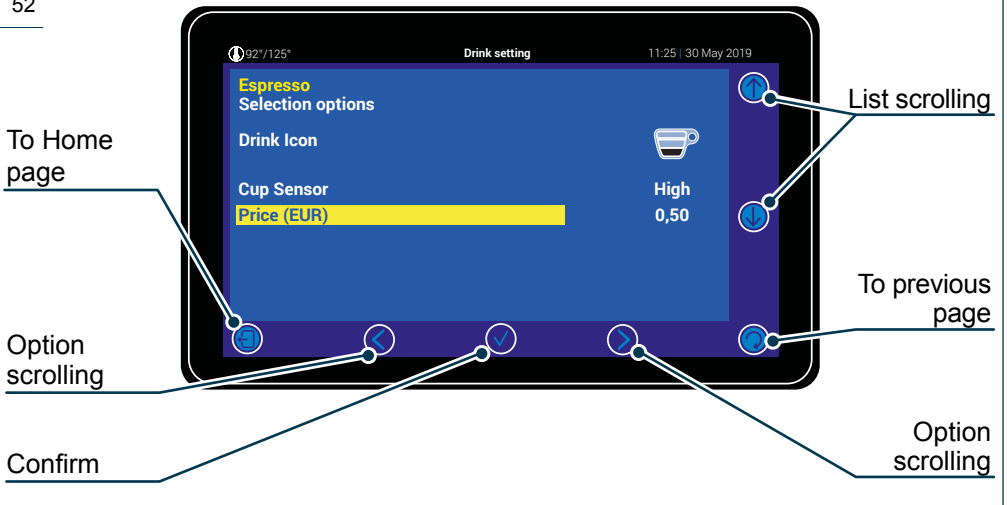

NOTE



The increase/reduce steps of the price can change according to the MDB module settings.

NOTE



If the price is set to zero, the beverage will be delivered free of charge.

53

Drink price



Available credit

NOTE



Based on available credit, the colour of the beverage prices will change:

- White: sufficient credit for dispensing.
- Red: insufficient credit for delivery.

NOTE



At the time of inserting the money into the MDB module, the value of the credit available on the display will become larger for a few seconds.

Press a beverage to be delivered in order to proceed.

54



Confirm dispensing

To drinks selection

If the credit inserted is more than the price of the beverage, the machine will dispense change (if present and a compatible MDB module has been enabled).

55

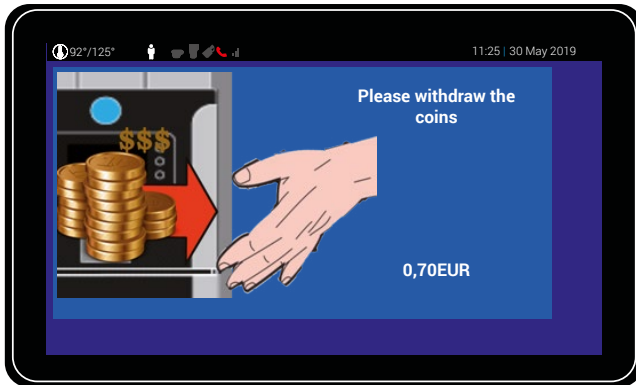

For further details on the MDB module, refer to the specific documentation.

3 TECHNICAL CHARACTERISTICS

3.1 TECHNICAL DATA

DESCRIPTION	DATA	UNIT OF MEASURE
Coffee boiler capacity	0.6	Litres
Steam boiler capacity	0.6	Litres
Coffee boiler heating element	1800	W
Steam boiler heating element	1200	W
Grounds compactor	75	Pieces
Coffee bean container capacity	0.6 (1.8)	kg (Litres)
Capacity of raised coffee bean container (optional)	1.2 (3.5)	kg (Litres)
Water mains pressure (version with Water connection)	Max ~ 6 (0.6) Max ~ 1 (0.1)	bar (Mpa)
Instant product container capacity	0.8	Litres
Instant product raised container capacity (optional)	1.8	Litres
Drip tray capacity	1.0	Litres
Min./Max delivery height	80 - 170	mm
Tank capacity	4.0	Litres
Net/empty weight (without EVO Milker)	35	kg
Net weight (empty, with EVO Milker)	37	kg
Gross weight (machine loaded, without EVO Milker)	40	kg
Gross weight (machine loaded, with EVO Milker)	42	kg
Voltage	220-240 V	V
Phase	1+N	/
Frequency	50 - 60	Hz
Power	2000	W

NOTE



According to Customer's requirements, it is possible to install the "Jolly" version of the machine, which allows to select the connection to water mains or the usage of water tank.

3.2 OVERALL DIMENSIONS

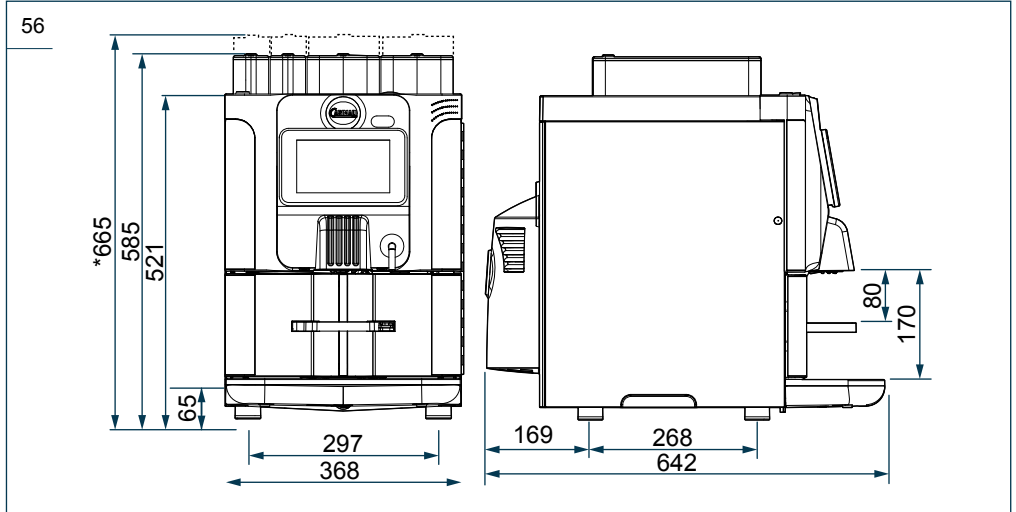

NOTE



* = Overall machine dimensions with raised containers installed.

4 INSTRUCTIONS FOR USE

4.1 GETTING STARTED

4.1.1 Water tank filling



Open the lower door.

57



Remove the water tank.

58

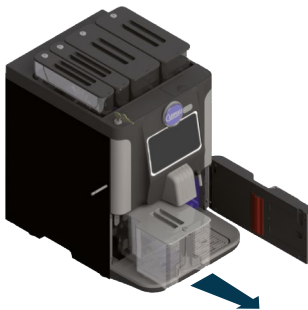

Fill the tank using still drinking water.

59

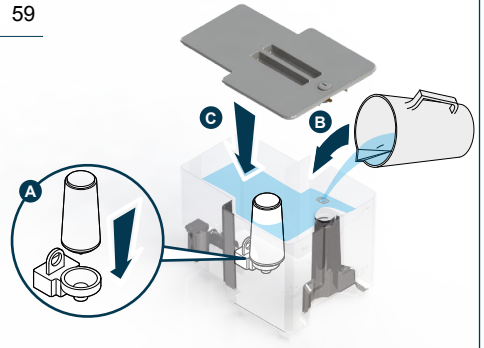

NOTE



Fill the tank up to the max. level.

NOTE



Always install the opposite filter CARIMALI (CARIPure100 Water Filter) into the tank. Once having inserted the adapter, always use the filter for the correct indication of empty tank.

NOTE



For more details on the CARIPure100 filter installation process, see the relevant section.

Re-position the water tank.

60

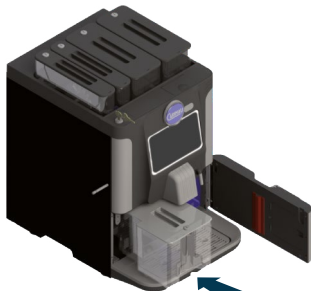

Close the lower door.

61

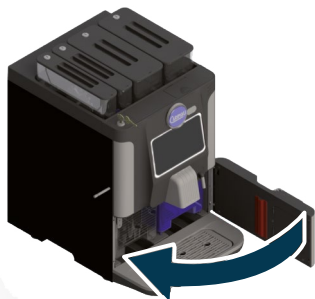

4.1.2 Product filling



Open the required product container using the corresponding key.

62

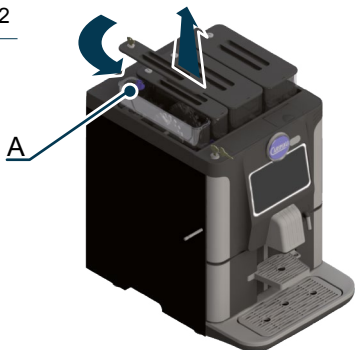

NOTE



Before pouring the product into the container, close the blue lock protection plug "A".

Pour the required product into the container, avoiding to pour it onto the machine.

63

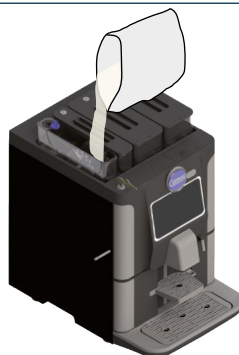

NOTE



Before closing the container, open the blue lock protection plug "A".

Close the container using the lock.

64



NOTE



Properly close the containers to prevent a machine stop.

NOTE



The process is valid, even if the optional raised containers are fitted.

4.2 SWITCHING ON



After carrying out the installation and the preliminary operations, switch on the machine.

ATTENTION



In case the appliance has not been working for some days, before use, empty the water tank (if fitted) and rinse with running water. Then, fill it again up to the max level with drinking water.

Press the switching on key.

65



When the machine is on, the following screens appear.

66

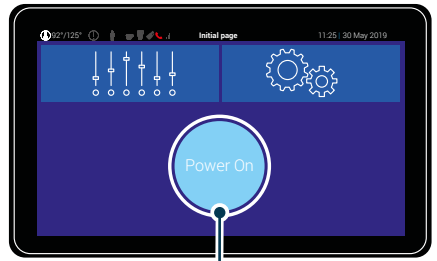

Machine Power on

Before the coffee boiler reaches the temperature, it remains on hold on heating.

67

Temperature gauge

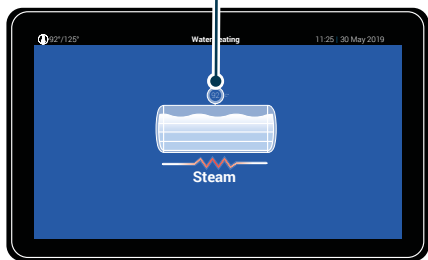

The heating of the steam boiler begins after heating of the coffee boiler.

68

Temperature gauge

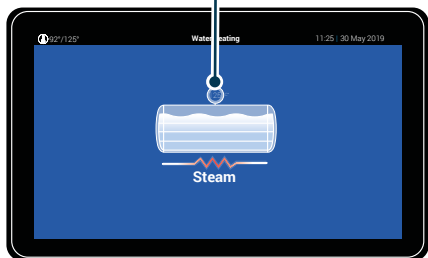

NOTE



Allow the machine to heat up before proceeding with drink dispensing.

4.3 DRINK DISPENSING



Once the machine reaches the working temperature, it is possible to proceed with drink dispensing.

For dispensing, press the key corresponding to required drink.

NOTE



WATER SYSTEM FILLING:

When installing for the first time or after emptying, carry out the boiler filling procedure.

4.3.1 Boiler filling

This operation serves to fill the filter, the pump and the circuit of the boiler.

ATTENTION



By omitting this operation, the machine may be seriously damaged and the Manufacturer's liability on machine functioning shall lapse immediately.

With the first installation or every time the machine is emptied with the appropriate procedure, press the “Boiler fill” key to fill the boiler. Press “System Manager” to go back to the menu.

4.3.2 Dispensing circuit washing

WARNING



When using for the first time, or after a long period of disuse, wash the dispensing circuit to eliminate any impurities that may be in the boiler or system.

69

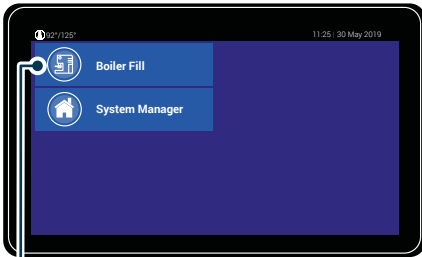

Boiler filling

Await until boiler filling is completed.

70

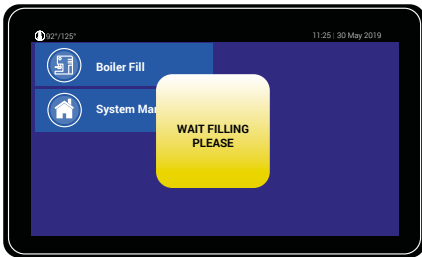

Once the procedure is completed, the screen “Home page” appears.

71

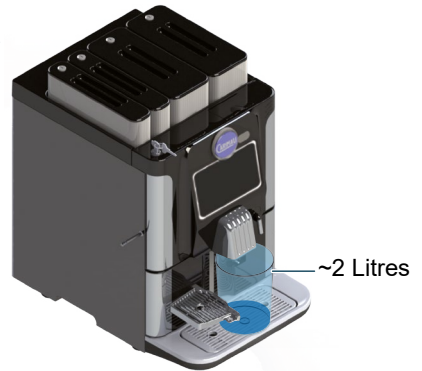

Perform the following method in sequence:

- Dispense 4-6 litres of water according to model, from:
 - Hot water spout (if fitted);
 - Water by-pass (if fitted);
- Start a “All-in-one” washing, to be repeated twice or three times (see the relevant description paragraph).



DANGER

The intervention of routine maintenance and cleaning must be performed by the operator only after:

- having switched off the machine
- having disconnected the machine power supply, by unplugging it;
- having closed the tap upstream of the water mains connection (if available on the machine version)
- having awaited the cooling time of the machine.

The operator must always use protective gloves to prevent abrasions.



WARNING



Do not pull the power cord or the machine itself to unplug the machine from the electric power socket.

WARNING



Each operation requiring disassembly of the machine parts must be performed by a skilled technician.

WARNING



To ensure the perfect preservation of the hygiene requirements envisaged by the manufacturer, carry out all the cleaning and sanitization operations set forth in the following plan by referring to the procedures indicated.

WARNING



For cleaning and sanitization operations of the various circuits, use only Carimali products or the ones having the features indicated in this manual.

OPERATION	TYPE OF OPERATION	FREQUENCY	PARAGRAPH
Display cleaning	Manual	Daily	5.1.1
External cleaning of chrome-plated surfaces	Manual	Daily	5.1.2
External cleaning of machine surfaces	Manual	Daily	5.1.3
Emptying and cleaning the liquid grounds container	Manual	Daily or before if necessary	5.1.4
Emptying and cleaning the solid grounds container	Manual	When counting is reached	5.1.4
Instant product / coffee bean containers	Manual	Weekly	5.1.5
All in One cleaning	Semiautomatic (alternative to single semiautomatic procedures)	Daily	5.2.2
Espresso/CARIBrew group cleaning	Automatic (Light)	Several times during the day, if possible	5.2.4
	Semiautomatic	Daily	5.2.3
	Manual	Weekly	5.2.5
Mixer cleaning	Automatic	Daily	5.2.6
	Manual	Weekly or when necessary	5.2.7
EVO Milker circuit cleaning	Semiautomatic	Daily	5.2.8
	Manual	Weekly or when necessary	5.2.9
Water tank cleaning	Manual	Weekly	5.2.10
Replacement of Filter CariPure100	Manual	100 Litres of delivery	2.5.8 4.1.1
Outer softener filter (if present)	See the related Manufacturer's instructions.		

For cleaning the inner components, open the front door of the machine by using the keys supplied.

5.1.2 Cleaning of chrome-plated surfaces

72



5.1 EXTERNAL CLEANING

5.1.1 Cleaning the display

73



WARNING



Do not use alcohol, solvents or abrasive agents to carry out this operation.

74



WARNING



For cleaning the chrome-plated surfaces, use a damp cloth, an antistatic cloth or similar. Do not use abrasive agents to carry out this operation.

5.1.3 Cleaning of machine surfaces

Proceed with the daily external cleaning of the machine using a cloth dampened with water and then dry thoroughly.

WARNING



Do not use solvents, chlorine-based products or abrasive agents to carry out this operation. Do not clean the machine with direct water jets. Never immerse the machine in water or other liquids.

5.1.4 Cleaning of solid/liquid grounds container

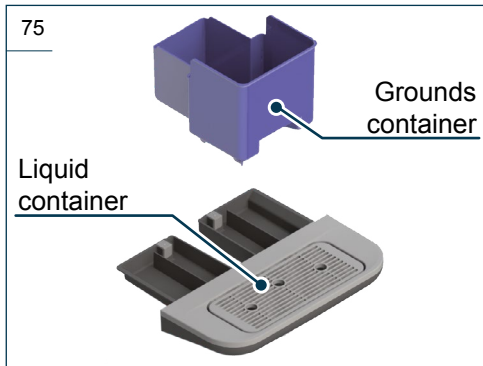

NOTE



Wash with water and cleaning agent thoroughly. Rinse under running water and dry well to prevent the proliferation of bacteria.

ATTENTION



When cleaning the grounds container, take care not to damage the grounds compactor.

5.1.5 Cleaning of instant products/ coffee bean containers

Carry out the following procedures for cleaning the containers of instant products and coffee beans:

Open the upper front door.



Remove the instant product containers from the machine.

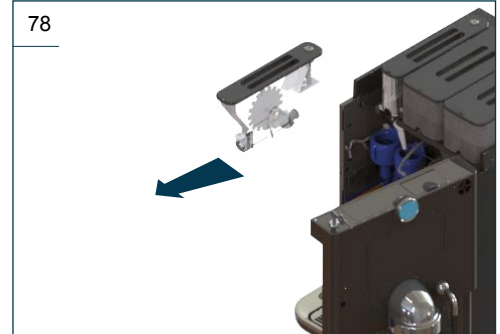
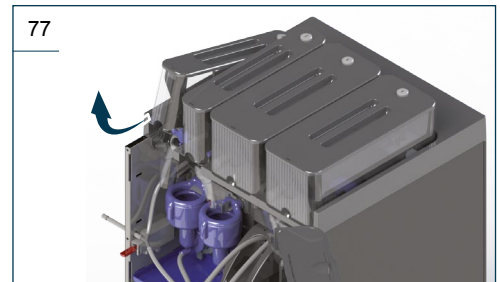

Press the flap to close the side.

79 (view from the bottom up)



Remove the coffee containers from the machine.

80

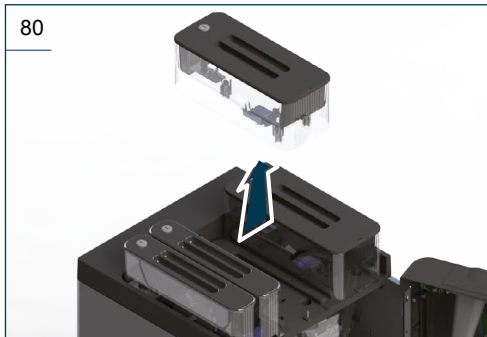

Open the containers using the apposite key.

81

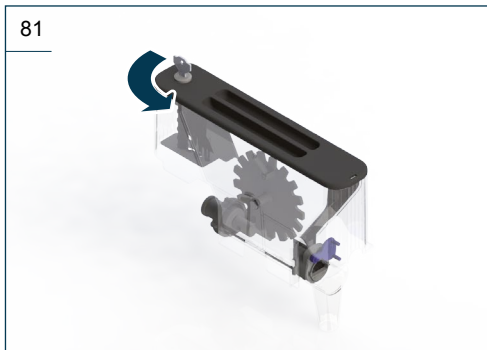

82

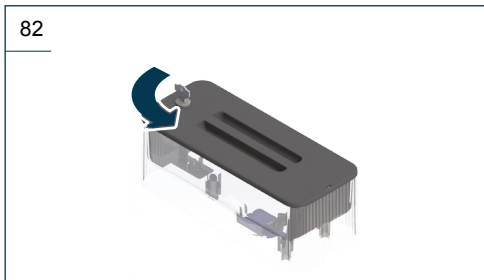

Clean with a solution of hot water and sanitizing product.

Rinse and dry thoroughly.

Insert the containers into the machine.

NOTE



In case the containers required by the configuration are missing or are not inserted properly, the machine stops working.

NOTE



The process is valid, even if the optional raised containers are fitted.

5.2 CLEANING OF FUNCTIONAL UNITS

5.2.1 Cleaning mode access

83

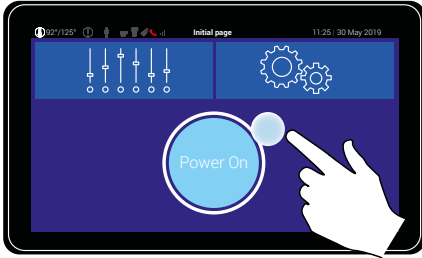

84

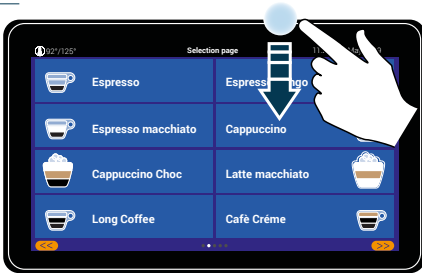

85

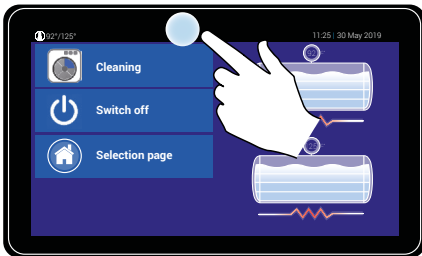

If enabled, the machine can require washing for a group/circuit.

86



Press to postpone the wash

Press to proceed with washing.

NOTE



If the installation technician has enabled the Timer washing function, when the pre-set time is up, the machine will require it. This can be postponed, if necessary, once only. The EVO Milker must be washed at least on a daily basis.

NOTE



The "Skip" function might not be enabled and as a result, not view the second machine configuration in the display.

5.2.2 All in One cleaning

This type of wash makes it possible to carry out all possible washes according to the machine configuration and in the following sequence:

1. EVO Milker wash;
2. Mixer wash;
3. Espresso group washing.

NOTE



If the machine configuration does not contain a group or circuit, the wash will automatically pass to the group or the next circuit present.

NOTE



To carry out this procedure, follow the instructions on the display.

Before proceeding with an All in One wash, according to the machine layout:

- If there is a EVO Milker circuit, insert the float in a container with water and Carimali sanitizer (06.00136). Follow the instructions on the sanitizer package for a proper dilution.

- Put a container of approx. 2 l under the dispensing nozzle to collect the cleaning liquids.
- In machines with tank (WT), fill the tank with water up to the MAX level.

87

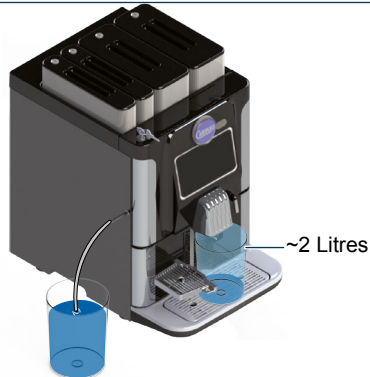

From the cleaning menu, select “All in one”.

88

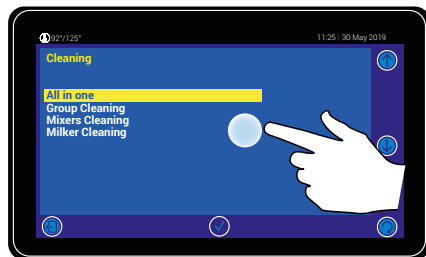

1. The insertion of the cleaning tablet in the Espresso group will be requested on the display. Press **START** to start the procedure.

89

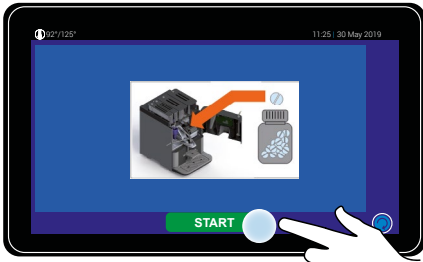

2. Open the rear door of the machine and insert a CARIMALI tablet (06.00133) into the Espresso group.

90

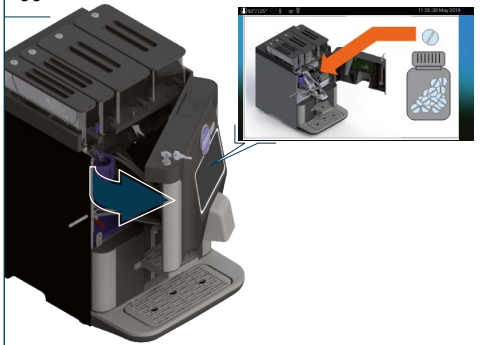

ATTENTION



In the machine version with tank (WT), check and fill the water tank up to the MAX level if necessary. It is absolutely necessary to ensure that there is enough water during the cleaning cycle.

NOTE



The selected group sets itself in position for tablet insertion.

3. Close the door and the machine will turn on automatically.

91

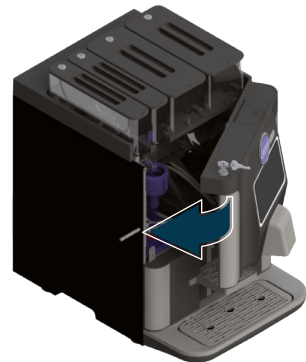

92

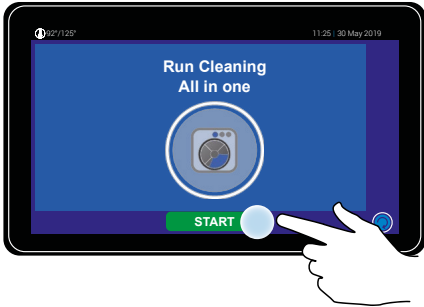

4. On machines with tank (WT), the display will show a reminder to fill the tank with water up to the MAX level.

94

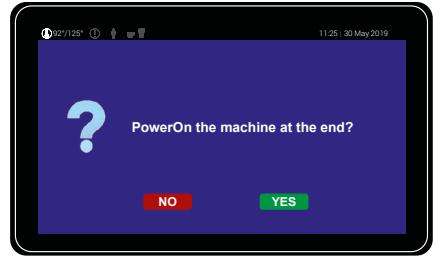

5. Connect the Milker circuit to a container with water and CARIMALI sanitizer (06.00136), if fitted in the machine configuration.

93

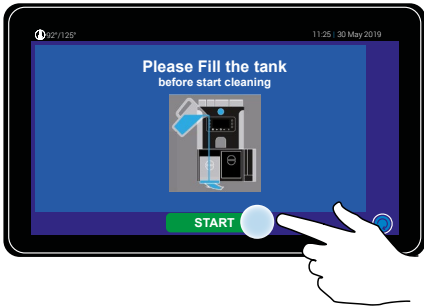

95

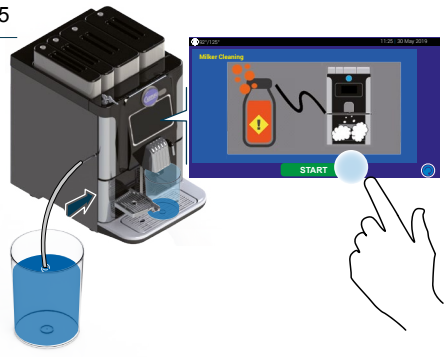

- Press **NO** to switch the machine on again on the drink selection page once the washing cycle is complete.
- Press **YES** to switch on the machine again on the "First page" once the washing cycle is complete.

ATTENTION



Follow the instructions on the sanitizer package for a proper dilution.

6. Clean the milk dip tube.

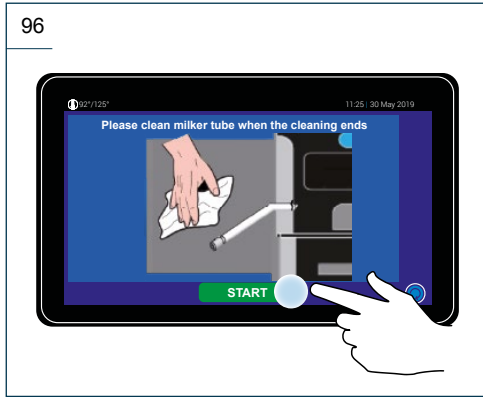

The machine will carry out the wash, showing the following screen:

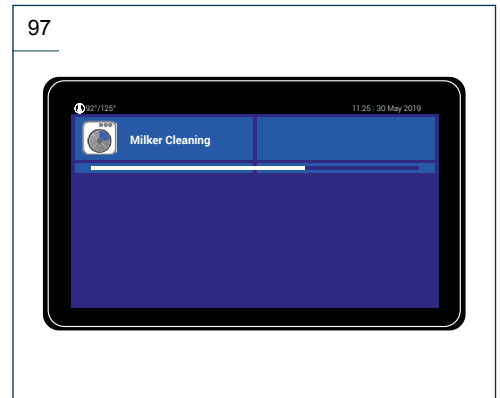

NOTE



The machine will perform the complete rinsing of the EVO Milker circuit automatically, by drawing water from the can or the water circuit, according to configuration.

ATTENTION



Once the “All in One” washing cycle has been completed, remove the milk float (if present) from the container of water and sanitizer and rinse it carefully.

ATTENTION



Before proceeding with the normal use of the machine, carry out some test dispensing cycles.

5.2.3 Semi-automatic cleaning of the Espresso/CARIBrew group

NOTE



To carry out this procedure, follow the instructions on the display.

From the cleaning menu, select “Group Cleaning”.

98

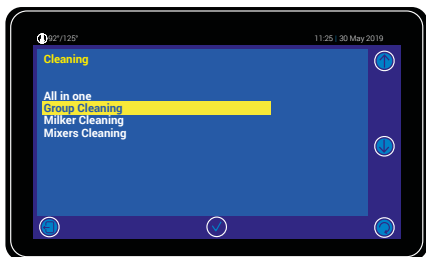

Select “Semi-Automatic ES” to proceed with cleaning of the Espresso group.

99

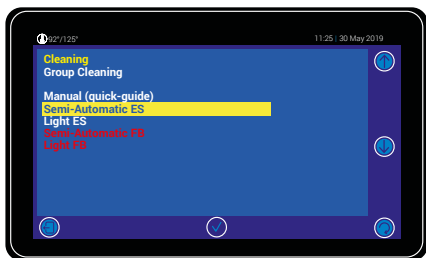

NOTE



The selected unit prepares in position for tablet insertion.

Once having selected the cleaning mode, the following screen is displayed. Open the door and insert a CARIMALI tablet (06.00133) into the group.

100

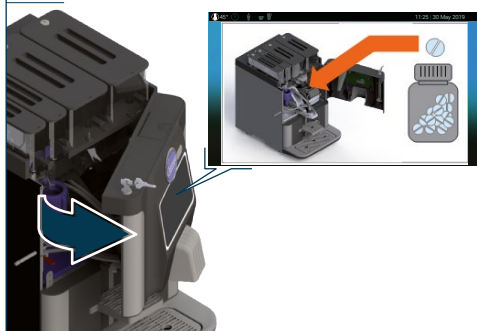

ATTENTION



In the machine version with tank (WT), check and fill the water tank up to the MAX level if necessary. It is absolutely necessary to ensure that there is enough water during the cleaning cycle.

Close the door and the machine will turn on automatically.

101



NOTE



The cycle lasts approximately 8 minutes. Put a container of approximately 2 l under the dispensing nozzle to collect the cleaning liquids.

NOTE



If the washing cycle is suddenly interrupted before it is completed, the group will return to the idle position (HOME) and the machine will carry out an automatic rinse cycle. To perform a complete cleaning cycle, always repeat the procedure from the beginning, verifying the rinsing is carried out.

ATTENTION



At the end of the cycle, the “Initial page” screen is shown. Before proceeding with the normal use of the machine, carry out some test dispensing cycles.

5.2.4 LIGHT cleaning of the Espresso/CARIBrew group

NOTE



This type of washing does not require the use of tablets or the need of opening the machine. The only ingredient used for cleaning is hot water from the water distribution system/water tank.

ATTENTION



In the machine version with tank (WT), check and fill the water tank up to the MAX level if necessary. It is absolutely necessary to ensure that there is enough water during the cleaning cycle.

NOTE



The procedure is identical for both units.

From the cleaning menu, select “Group Cleaning”.

102

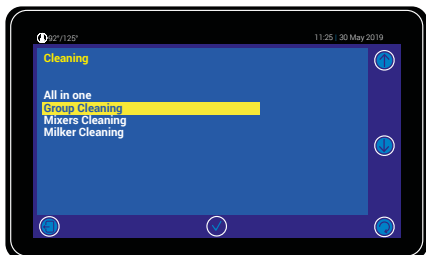

Select “Light ES” to proceed with cleaning of the Espresso group.

103

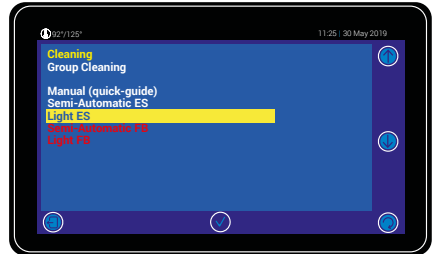

Await until the cleaning of the selected group is complete.

104

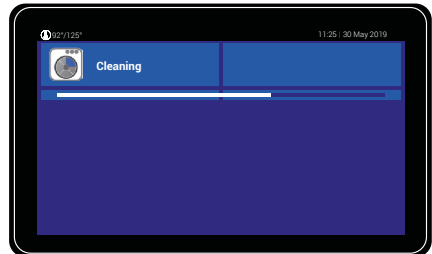

NOTE



The wash will take about 1 minute and use about 150 ml water.

ATTENTION



At the end of the cycle, the cleaning menu is shown. Before proceeding with the normal use of the machine, carry out some test dispensing cycles.

From the cleaning menu, select “Group Cleaning”.

105

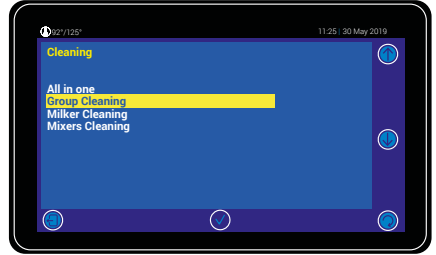

5.2.5 Manual cleaning of the Espresso group

NOTE



Carry out this procedure for a manual cleaning of the components or in case of complete / partial replacement of the Espresso unit.

Select the entry “Manual (Quick Guide)”.

106

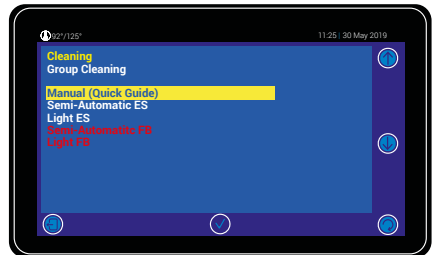

NOTE



To carry out this procedure, follow the instructions on the display.

NOTE



The unit moves to the rest position.

Open the front door.

107

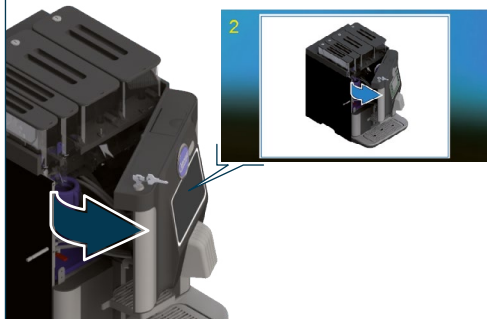

Release the "A" fitting, pressing on the button, then slide out the pipe "B".

108

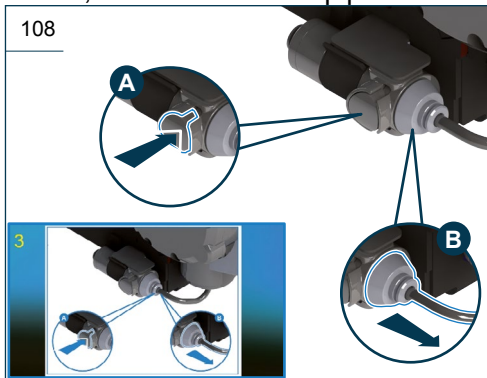

Slide out the waste pipe "A" and press the lever "B" inwards to free the group.

109

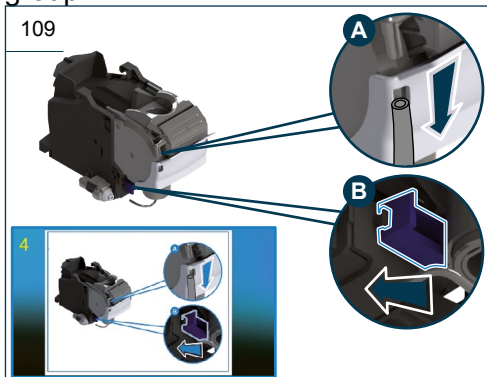

Remove the unit towards the front side of the machine.

110

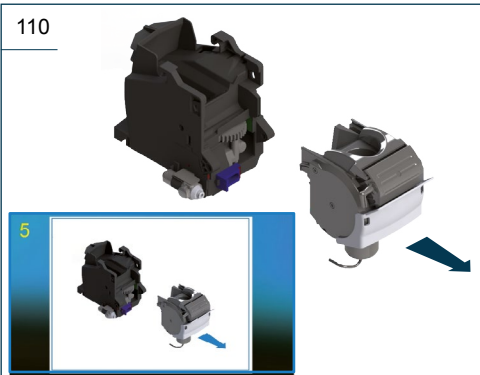

Clean the Espresso group with warm water.

111

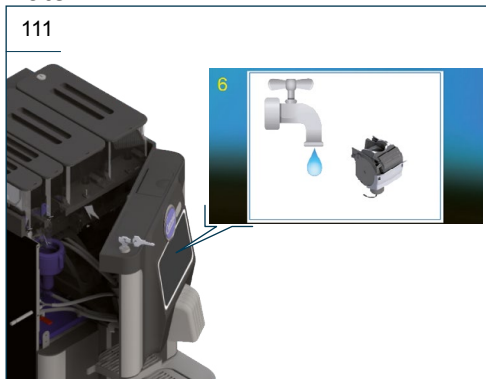

ATTENTION



Adjust the water temperature to prevent the risk of burn.

WARNING



If the water is too warm, there is a risk of removing the lubricant in the group.

WARNING



For cleaning the components, make sure the inner channels and edges are cleaned and rinsed.

Required tools for cleaning:

- CARIMALI brush (95.01806);
- Lukewarm water.

Insert the brush into the Espresso unit and remove the residues.

112

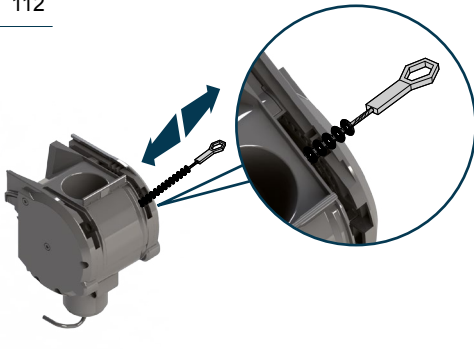

Rinse the Espresso unit thoroughly using lukewarm water and manually rotate the gears.

113

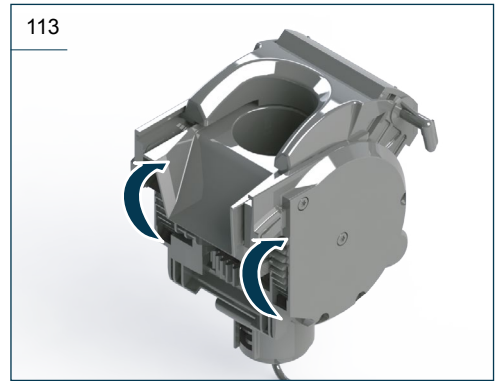

ATTENTION



Make sure the components are perfectly dry before installing them again on the machine, to prevent bacteria growth.

NOTE



Assemble the Espresso unit by proceeding in the reverse order compared to the above instructions.

NOTE



At the end of the cycle, the “Initial page” screen is shown.

5.2.6 Mixer automatic cleaning

NOTE



This procedure can be carried out following the instructions on the display.

ATTENTION



In the machine version with tank (WT), check and fill the water tank up to the MAX level if necessary. It is absolutely necessary to ensure that there is enough water during the cleaning cycle. The water consumption is approx.ly 1.5 l.

NOTE



Put a container of approx. 2 l under the dispensing nozzle.

From the cleaning menu, select “Mixer Cleaning”.

114

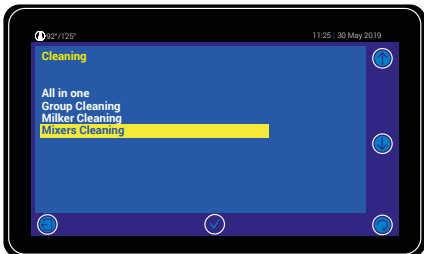

NOTE



The machine carries out the cleaning automatically.

Await until the cleaning of the selected group is complete.

115

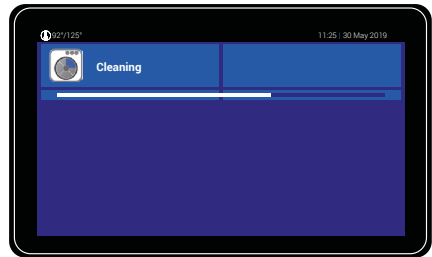

ATTENTION



At the end of the cycle, the cleaning menu is shown. Before proceeding with the normal use of the machine, carry out some test dispensing cycles.

5.2.7 Disassembly and manual cleaning of the instant products Mixer

ATTENTION



Open the upper front door of the machine and disconnect the hoses that might interfere with this procedure.

Rotate the chute(s).

116

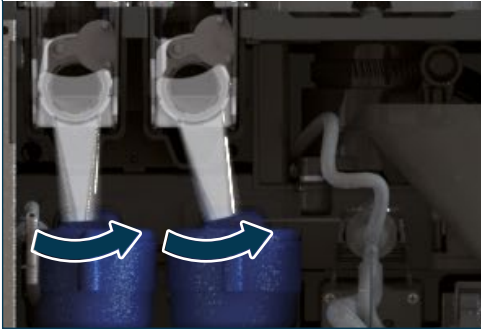

Rotate the ring nut to match the tabs with the relevant slots and free the mixer.

117

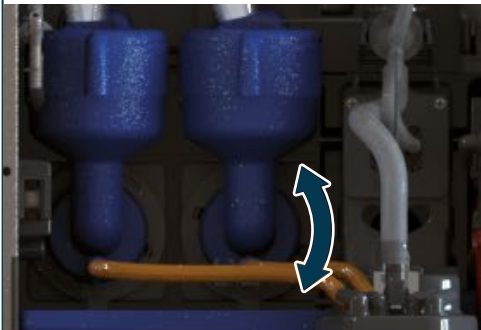

Slide the mixer out towards the front of the machine.

118

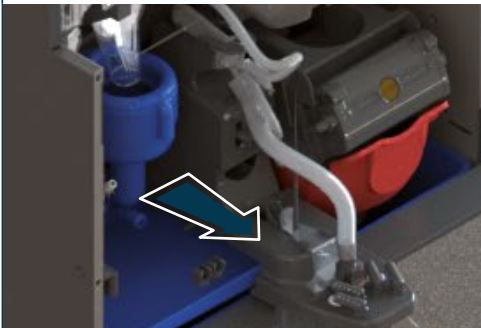

ATTENTION



Do not put in the dishwasher.

NOTE

For cleaning operations, use the CARIMALI cleaning agent (06.00136).



Required tools for cleaning:

- Hot water;
- Cleaning agent.

Immerse all components in a solution of hot water and cleaning agent CARIMALI.

119

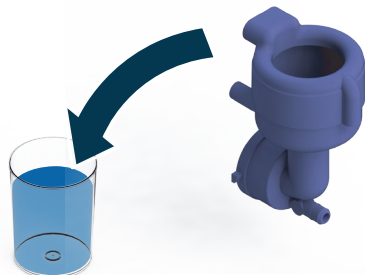

Immerse all components in a solution of hot water and cleaning agent CARIMALI.

120

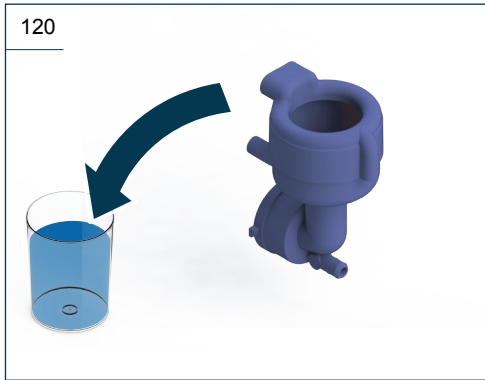

Rinse all components with running hot water.

ATTENTION



Make sure the components are perfectly dry before installing them again on the machine, to prevent bacteria growth.

NOTE



Assemble the Mixer by proceeding in the reverse order compared to the above instructions.

5.2.8 EVO Milker circuit cleaning

NOTE



This procedure can be carried out following the instructions on the display.

NOTE



Put a container of approx. 2 l under the dispensing nozzle to collect the cleaning liquids.

NOTE



Once having confirmed the cycle start, it cannot be cancelled.

ATTENTION



When using the Milker, carry out the procedure of semi-automatic cleaning at least once a day. If the Milker is intensively and/or the room temperature is high, it is advisable to increase the cleaning number.

From the cleaning menu, select “Milk-er Cleaning”.

121

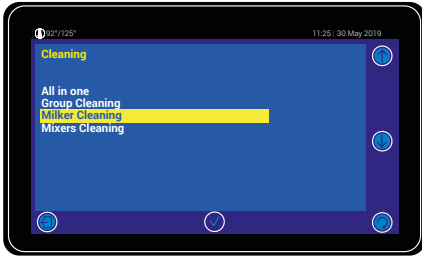

Connect the Milker circuit to a container with water and CARIMALI sanitizer (06.00136). Follow the instructions on the sanitizer package for a proper dilution.

122

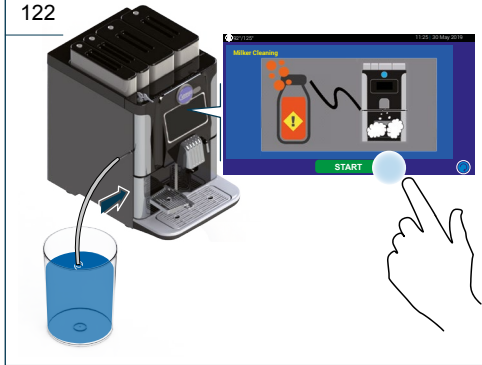

Await until the Milker cleaning is complete.

123

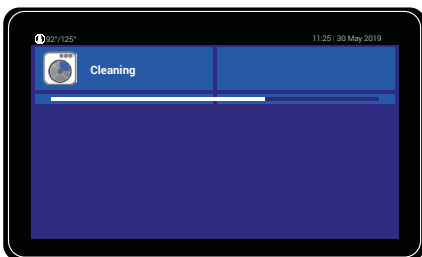

NOTE



For the complete rinsing of the Milker circuit, use more than 1 l of fresh water.

NOTE



Put a container of approx. 2 l under the dispensing nozzle.

When shown on the display, connect the Milker circuit to a container with fresh water for rinsing.

124

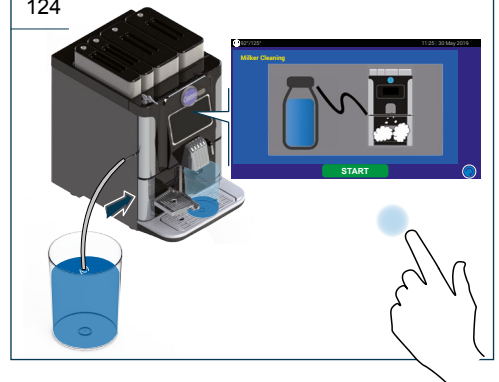

Await until the Milker rinsing is complete.

125

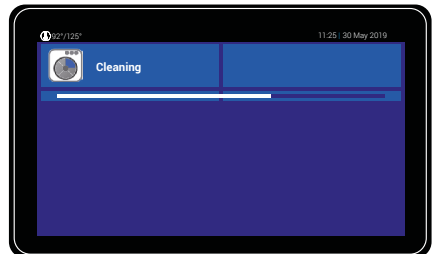

ATTENTION



If the cleaning cycle is stopped suddenly before its completion, always repeat the procedure from the beginning, making sure the rinsing phase is carried out.

ATTENTION



At the end of the cycle, the cleaning menu is shown. Before proceeding with the normal use of the machine, carry out some test dispensing cycles.

5.2.9 Disassembly and manual cleaning of EVO Milker

Besides the automatic daily washing/sanitisation cycle, it is necessary to proceed on a weekly basis with the manual disassembly and the mechanical washing of the passage holes using the apposite brush supplied.

Proceed with EVO Milker disassembly first.

With the machine in standby, open the door and identify the EVO Milker position.

Pull the black flap upwards to release the transparent body of the EVO Milker, so that it can be removed from its seat.

126

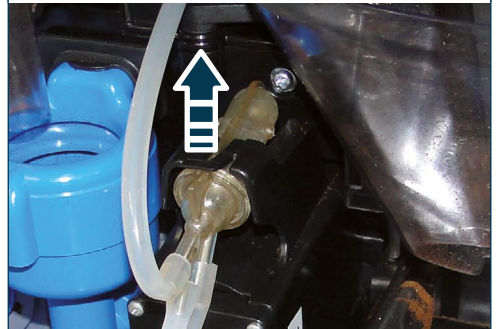

When the group is released, remove it from its seat.

127

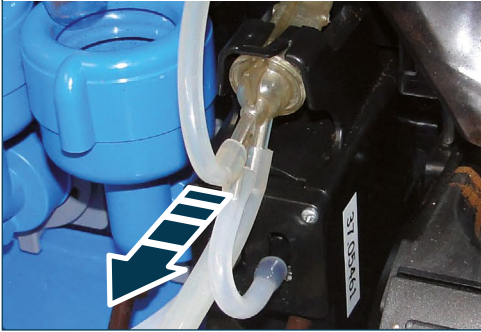

Take out the connection hoses, paying attention to their position on the EVO Milker.

Use the brush supplied to wash the milk passage holes thoroughly.

128

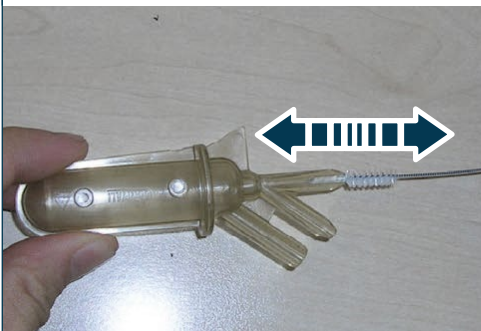

At the end of the procedure, rinse thoroughly the EVO Milker under running water and refit the device in its position by following the reverse order of disassembly.

After having assembled all parts, carry out an All in One washing cycle.

5.2.10 Water tank cleaning

ATTENTION



To prevent the proliferation of bacteria, in case unused water remains in the tank for more than two days, it is necessary to empty the tank and wash it with dish soap.







Rinse the tank well before adding fresh water again and refit it onto the machine.

6 TROUBLESHOOTING

ATTENTION



For faults or situations not described in this manual or when necessary, contact the Service centre.

FAULT	POSSIBLE CAUSE	POSSIBLE SOLUTION	USER
The machine does not turn on (TFT off).	Wrong connection to the power mains.	Check the plug and the main switch of the room. Check and repair wiring.	
	Faulty door safety micro switch.	Contact the Service centre.	
	General electric failure.	Contact the Service centre.	
Drinks dispensed incorrectly.	Obstructed dispensing nozzle/s.	Carry out an All-in-One washing cycle. Carry out washing of the coffee and EVO Milker group.	
Machine is on but does not dispense anything (block situation with alarm on the display).	Wrong closing of product containers.	Check and close well the product containers. Position them properly.	
	Grounds drawer not inserted.	Check and insert the drawer properly.	
	Fault of the Air Break, of the hydraulic connection or of the tank.	Contact the Service centre.	

6.1 ESPRESSO GROUP ERRORS

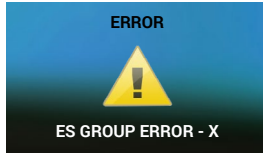





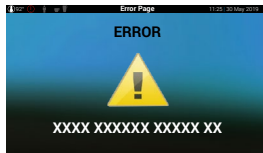



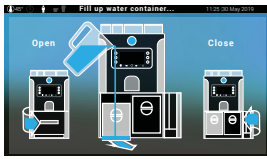

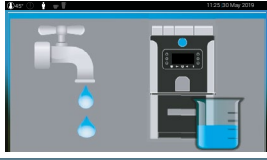
Error NO.	POSSIBLE CAUSE	INTERVENTION
7	The SLIDER does not reach the dispensing position.	<ul style="list-style-type: none"> • Disconnect and then connect power to machine again. • Clean the coffee group under running water. • Check sensors. • Check motor.
12	Position of coffee ejection.	<ul style="list-style-type: none"> • Make sure grinding is not too fine. • Check quality of ground coffee. • If it delivers too much water, check volume. • Disconnect and then connect power to machine again. • Check the group fuse + motor encoder. • Clean the motor and encoder.

6.2 GENERAL ERRORS



MESSAGE	POSSIBLE CAUSE	INTERVENTION	USER
INSERT DRIP TRAY	Drip tray not inserted or not inserted properly.	Insert the drip tray correctly.	
DRIP TRAY FULL	Drip tray full.	Remove the drip tray. Empty the drip tray. Re-insert the drip tray.	

MESSAGE	POSSIBLE CAUSE	INTERVENTION	USER
	Minimum level of water in the tank.	Carry out the procedure shown on the display.	
	Minimum level of water inside (Air break).	Await the water filling in the Air-Break.	
COFFEE GROUNDS DRAWER FULL	When the number of grounds set is reached, the alarm appears and the machine stops.	Empty the drawer and clean it. Follow the instructions on the display.	
COFFEE GROUNDS DRAWER FULL RESET FOUNDS	When the number of grounds set is reached, the alarm appears and the machine stops.	 <div style="border: 1px solid black; padding: 5px; margin-top: 5px;"> <p>NOTE</p> <p>This message is visible only if the "Cup Station" option is enabled.</p> </div> <p>Open the front door (the machine stops automatically). Empty the drawer, then close the front door (the machine starts automatically). Reset the counter by pressing  when this message appears.</p>	
INSTANT X	Instant product containers not inserted or not inserted properly.	Insert the instant product container(s) properly.	
COFFEE HOPPER X	Coffee containers not inserted or not inserted properly.	Insert the coffee container(s) properly.	

7 DECOMMISSIONING AND DISPOSAL

This machine is compliant with the Directive 2012/19/EU.

WARNING



When the machine is not used any longer, render it inoperative after having unplugged it and having cut the power cord.

The disposal of the machine is not responsibility of the Manufacturer and must be carry out in compliance with the applicable regulations.

The Customer is held to deliver the material to the designated collection facilities.

WARNING



Follow the aforesaid disposal procedures, subject to penalties set forth in the applicable waste legislation.

CARIMALI

Carimali S.p.A.
Via Industriale, 1
Chignolo d'Isola (BG)
24040 - ITALY

 +39 035 4949555

 +39 035 905447

 info@carimali.com

 carimali.com

