

OPERATING MANUAL

UĞUR COMMERCIAL TYPE UPRIGHT COOLER



EN

THIS MANUAL COVERS THE FOLLOWING MODELS

USS 60 DTKL	USS 220 DTK BK	USS 374 DTK BK	USS 440 DTKL SZ BK
USS 95 DTKL	USS 95 DTKL SZ	USS 1200 DIKLM	
USS 100 DSCL	USS 374 DTKLE	USS 440 DTKLB	
USS 190 D2KL	USS 374 DTKL	USS 700 DTKL	
USS 220 DTK	USS 374 D2KL	USS 1100 DSC	
USS 220 DTKL	USS 380 DTKL	USS 1100 D2KL	
USS 275 DTK	USS 748 D2KL	USS 1000 DIKL	
USS 275 DTKL	USS 440 DTKL	USS 1000 D2KL	
USS 300 DTK	USS 690 DTKL	USS 1000 DSCL	
USS 220 DTK Premium	USS 690 DTKL LCD	USS 1200 DSCL	
USS 220 DTK Premium	USS 691 DTKL LCD	USS 1200 D2KL	
USS 300 DTKL	USS 300 DTKL	USS 1800 D3K	
USS 374 D2K	USS 374 D2K	USS 1800 D5K	
USS 60 DTKL	USS 60 DTKL	USS 374 DTK BK GST	

INFORMATION

Dear Customer,

In order to use your upright cooler, which was manufactured and quality controlled in Uğur Soğutma A.Ş. plants with great care, more efficiently, we kindly request you to read this manual carefully and completely before start using your product, to keep it for further reference and to use your product according to the terms stated herein.

If you fail to use your product according to the rules and instructions contained in this manual and/or in case of any usage error, our Company shall not be anyway responsible from the breaking down of your product.

You can find the updated version of the operating manual from our web site www.ugur.com.tr.



This product was manufactured in modern environment friendly plants. It has eco-friendly technology.

Dear Customer,

The product you bought was manufactured by using asbestos, formaldehyde, cadmium and CFC-free substances as well as compressor oil that does not contain PCB, PCT throughout the production process. The gas used in your cooler is R134a, R404a, R290 and R600a. These gases conform to KYOTO Protocol.

Service life of your exposed cooler is 10 years if the terms and instructions given in this manual are abided and ordinary conditions of use are provided.

Your cooler conforms to WEEE (Waster Electric and Electronic Equipment) Directive.



IMPORTANT

Dear Customer,

Always ensure that introduction and installation of your bottle cooler, which was manufactured in Uğur Soğutma A.Ş. plants with great care, are always carried out by Authorized Uğur Service Team. Your product will not be under warranty in case of any failure if the introduction and installation of your bottle cooler are

Dear Customer,

Points to consider within this manual are indicated under the headings WARNING, CAUTION, NOTE and SUGGESTION

These headings are defined according to the degree of importance and we kindly request you to read each of them carefully.

The information stated under headings WARNING, CAUTION, NOTE and SUGGESTION in this operating manual applies for all stages during the period of use of your product, including transportation and installation.

WARNING! 

Contains information for preventing serious damages, which may lead the product out of use, to injury, loss of life and property while the product is in use

CAUTION! 

Contains information for preventing the errors, which may decrease the efficiency of your product or failures while the product is in use.

NOTE

Contains explanatory information while the product is in use.

SUGGESTION

Contains information that may be useful while the product is in use.

NOTE

In case of any failure, please contact to our Call Centre, nearest Authorized Uğur Service or Customer Care Centre for obtaining information. Our Customer Care Center hotline is available at last page of the operating manual.

It is at the discretion of the consumer to take action related to the food inside your cooler in case of any failure. Our company is not responsible from the deterioration of your foodstuff due to any failure or usage error.

Our products are manufactured for cooling foodstuff and beverages. Our company is not responsible for any damage that may occur in the products, which are used for another purpose.

TABLE OF CONTENTS

A- Things that must be done before using your cooler and security warnings.

B- General appearance of your cooler

C- Installation of your cooler.

- Selecting the place of installation
- Positioning
- Hanging
- Installation
- Electric connection rules

D- Using your cooler

- Start-up
- Setting internal temperature of your product
- Using digital thermostat
- Loading foodstuff to your cooler
- Defrost function
- Shutting down your product

E- Cleaning, maintenance and transportation of your cooler

- Cleaning
- Internal cleaning
- External cleaning
- Transportation of your product

F- Things that must be done before calling Authorized Service

- Troubleshooting
- Digital thermostat failures

A- THINGS THAT MUST BE DONE BEFORE USING YOUR COOLER

WARNING!

- Do not place your product to a place exposed to direct sunlight or influence area of the heat sources such stove, radiator core, oven, cooker, radiant and infrared. Otherwise, this may cause performance decrease, damage of your product or make it become dysfunctional. (Picture 1)
- Your product is set for operating at mains power of 220-240 Volt 50 Hz. Using your cooler with a different voltage may cause it become dysfunctional and fire. (Picture 2)
- Electrical installation must conform to national regulations. (Picture 3)
- There must absolutely be a residual current relay and a fuse in your electrical installation for preventing the risks of electrical shock and fire.
- Our company is not responsible for the failures and damage that may occur in case of using without grounding.
- Place the product in a damp-free place with unobstructed air circulation.
- You must clean inside your product before the first use (see page 23)
- After placing your product to its place, wait for one (1) hour without moving it before start using.
- If your cooler is installed under very cold weather conditions, then the waiting period must be at least two (2) hours before start it to operate.
- If you do not use your product for a short time or leave it empty, do not unplug it for saving energy. Otherwise, more energy will be consumed for re-cooling your product.
- Unplug your product in case of sudden blackouts. For starting again, plug in your product 20 minutes after the electricity is supplied. High voltage occurring at the moment of electricity supply may cause damage of your product and fire.
- Do not allow wild animals and pets to enter into your product or walk around. It may damage your product or cause death and injury of the animals. Furthermore, wild animals and pets may cause fire by giving harm to the electrical installation.
- Never place hot foodstuff into your cooler for cooling purposes.
- The product you've purchased is designed and manufactured for cooling and storing bottles and/or canned beverages or packed food only. Please do not use for other purposes.
- Your product is designed for using at indoor places. Do not use your product at outdoor places.
- Do not place materials that must not be cooled down into your product. Do not use your product for defrosting frozen food.
- Product installation, placement, maintenance and cleaning must be done as stated in the manual. Do not apply anything contrary to the manual. In case of any damage that may happen in your product as the result of such use, warranty conditions will be invalid due to user error.
- Frost deposit will increase in the products, the doors of which are left open or opened-closed frequently and your product will not be able to perform cooling operation. Therefore, open your product's door only when you need. Make sure that the product's door is closed when you don't need.



Picture 1

Picture 2

Picture 3

A- THINGS THAT MUST BE DONE BEFORE USING YOUR COOLER

WARNING!

- Since an impact to the glass parts of the products with glass doors by a sharp, pointed object or its contact to a very hot substance may cause the glasses to be broken, this matter must be paid attention particularly.
- Place your product onto a flat surface with no slope in order to prevent sliding or tilt over of your product.
- Operate your product only at usage position.
- Do not expose your product to direct sunlight.
- Carry and store your product at normal using position only in order to protect it against damages. Actions in contrary may cause loss of the warranty rights.
- Make sure that the discharge valve is closed for preventing frost formation inside your product or high sweating on the glasses.

NOTE

It is at the discretion of the consumer entirely to take action related to the food inside your cooler in case of any failure. Our company is not responsible from the deterioration of your foodstuff due to any failure or usage error.

The product you've purchased is designed and manufactured for cooling and storing bottles and/or canned beverages or packed food only. Our company is not responsible for any damage that may occur in the products, which are used for another purpose.

Check your product if there are any failures or not immediately after receiving the product you've purchased. If there is any damage, contact to your seller within 24 hours.

CD letters are contained in the model names of the products which are custom made and not standard. Contact to the authorized services for the technical specifications of these products. In order to use your product efficiently and safely, please read this manual entirely before start using your product and keep it as a source of reference. You can find updated version of the operating manual from our web site www.ugur.com.tr or our authorized services.

This product contains (WEEE) classification symbol, which indicates electric and electronic hardware. Accordingly, the user must conform to 2002/96/EC European Directive for recycling in order to minimize the environmental impact of the relevant product.

When you intend to throw your product to garbage or to allocate it as scrap, please contact to Authorized Uğur Services for learning necessary information. Your device must be definitely delivered to local WEEE disposal institutions in such cases.

The pictures shown in this manual are representative only and may vary depending on the model. Since the specifications stated in this manual include all options, some of them may not be present at your product.

A-SAFETY PRECAUTIONS

WARNING!

The products mentioned in the manual are designed according to national and international security norms and produced under control.

Following matters must be considered for a safe and secure use.

- Check that your outlet is suitable for the operation of your product. Always use your product with grounded socket. Make sure that electrical installation of your building is convenient. Do not use displaced and loose outlets.
- Do not ever use your product with extension cord or power strip.
- Always follow the instructions in this manual while replacing the bulb. The power of the bulb to be replaced is indicated on the device declaration name label, the label just under the lamp and in this manual. Canopy lamps must only be replaced by Authorized Uğur Service.
- Lamp replacement for the lightings must only be made by Authorized Uğur Service.
- If power cable is damaged, its replacement must only be made by Authorized Uğur Service.
- Please call Authorized Uğur Service if you have any doubt about the electrical connection while the product is running.
- Always pull the plug by holding it from the plug-head. Never pull the power cord.
- Do not remove any external protective cover that are not stated in this manual. You may access electrical parts posing threat to life if the external protective covers are removed.
- Never use pressurized water for cleaning. Pressurized water may cause damage in live parts.
- Do not intervene the device directly in case of any failure arising from the electricity system of the device and/or the electrical installation it is connected. Call the nearest Authorized Uğur Service after breaking the electricity current by unplugging the device or turning of the switch.
- Never plug and operate a damaged (such as transportation damage) product. Always call the nearest Authorized Uğur Service.
- Always consider maximum loading capacity while loading your product with beverages. Do not exceed the loading line indicated in your product.
- Replacement for the live parts must only be made by Authorized Uğur Service.
- Always store packaging materials of your product out of reach of children. Packaging materials (nylon, Styrofoam etc.) may pose danger for children.
- The product you've purchased must not be used by physically (visual, aural) or mentally handicapped people, children and people with inadequate knowledge without surveillance of a person responsible for their safety. Children must be guarded while using the product and it must be ensured that they are not playing with the product.
- Do not use any material and metal that are not recommended by the manufacturer while defrosting. You may damage cooling parts.
- Do not damage cooling cycle components.
- Do not anyway use the products/materials, which are not recommended by the manufacturer company inside and outside the cabin.
- Make sure that the intervention to be made to your product is certainly made by authorized service.
- Do not carry, move the product under any circumstance while it is plugged in.
- Never carry out servicing and repair operations on the product while it is plugged in.
- Substances such as aerosol cans with flammable propellant must not be stored in this product.
- Always abide positioning rules of your product. Not abiding cooling shutter and grill layouts may cause fire danger.

A-SAFETY PRECAUTIONS

CAUTION!

Please check the refrigerant gas written on your product label.

Following 5 clauses cover the products containing R600a and R290 Hydrocarbon gas.

- Installation of this device must be only made by Authorized Uğur Service for reducing flammability dangers.
- Do not obstruct the ventilation holes on the device cover or body.
- Mechanical tools and other apparatus, other than the models recommended by the manufacturer, must not be used for accelerating defrosting operation.
- Cooling circuit must not be damaged.
- Electrical devices must not be used inside the food storage section of the device unless the models recommended by the manufacturer.
- Installation of this device must be only made by Authorized Uğur Service for reducing flammability dangers.

Following 4 clauses cover the products containing R744 refrigerant gas.

- The system contains high pressure refrigerant gas.
- Never intervene the system.
- Servicing must be provided only by expert people. Contact to the nearest Authorized Uğur Service.
- Contact to an experienced Authorized Uğur Service before disposal (throw away).

WARNING!

• If your product is damaged or not working properly, please unplug it from the wall outlet. Transfer the foodstuff inside of it to a convenient place and call the nearest Authorized Uğur Service.

B GENERAL APPEARANCE OF YOUR COOLER

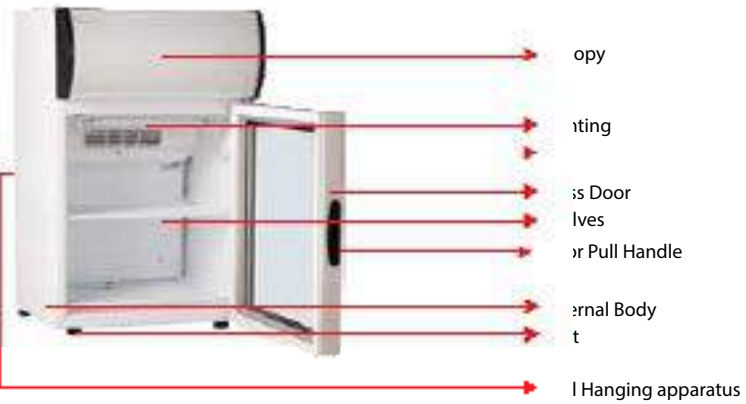

B GENERAL APPEARANCE OF YOUR COOLER



NOTE

Energy consumption test standard in commercial type products is EN23953-2.
 Product technical specifications are stated on the labels of the product. Uğur Soğutma A.Ş. reserves the right to change technical specifications of the products without any notice.

C -INSTALLATION OF YOUR COOLER.

Selecting the place of installation

The operating environment of the product is very important for the smooth operation of your product. While selecting the operating environment,

- Do not place your product exposed to outdoor environment (on the street, avenue etc.)
- Be careful for not obstructing lower shutter of the product with materials such as cardboard, box etc. for a proper cooling. (Picture 4)
- Place the product at least one (1) meter away from heat resources (ex: stove, radiator, electric heater etc.) (Picture 5)
- Do not place it opposite of the air conditioner chutes, under fans and direct door and window openings. (Picture 6)
- Do not expose to direct sunlight. Operation ratio will increase if sunlight comes to the cooler's glass. That means an increase in the energy consumption.
- Air intake and outlet must absolutely be fluent and free for proper operation of the compressor section of your product.
- While approaching your product to the wall, be careful that there is a gap of 150 mm (15 cm) between the wall and back of your cooler.

WARNING!

In very humid environments, ensure that floor and wall of the place where the cooler is located, is not affected by water; against discharge water overflow danger.

In installations performed by Authorized Uğur Service, Authorized Uğur Service shall inform the consumer on the suitable place for installation and make suggestion, but the consumer shall give the final decision on where the installation will be made. This process shall also be stated on the relevant installation form by Authorized Uğur Service. In case of any loss arising from the place of installation of the product according to the final decision given by the consumer, all responsibility related to such loss shall belong to the consumer.

Your product gives the best cooling performance according to the climate condition under the conditions given below. Therefore, be careful that the temperature of the environment where your cooler will be operated, is at these levels.

Climate Class	Temperature Range	Humidity
Class 3	16 °C to 25 °C	%60 Rh
Class 4	16 °C to 30 °C	%55 Rh
Class 5	16 °C to 40 °C	%45 Rh

Climate Class of your product is indicated on the technical specification label on the product.



Picture 4

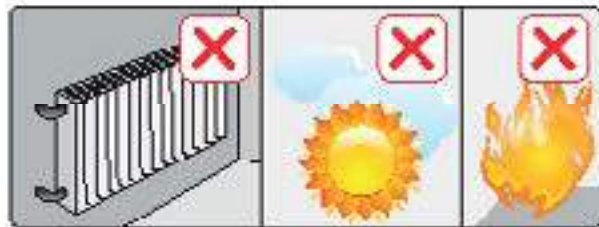

Picture 5



Picture 6

C -INSTALLATION OF YOUR COOLER.

Positioning

Possible placement positions:

1- In a way that the back side alone is opposite to the wall; be careful that there is a gap of 150 mm (15 cm) between the wall and your cooler. (Picture 7)

2- In a way that is place to a corner; when you place to a corner, leave a gap of 150 mm (15 cm) behind. You can lean the side corresponding to the corner, to the wall.

The most important point to be considered in all cases of product placement is not to obstruct ventilation of the compressor assembly.

Without expose your product to any slope, place and operate it in a manner that it is on its feet or wheels. (Picture 8)

The freer the compressor assembly ventilation is, the better the device will run.



Picture 7



Picture 8

C -INSTALLATION OF YOUR COOLER.

Hanging

DİKKAT!

- There is wall hanging apparatus only behind USS 60 / USS 95 and USS 100 models. You do not need to leave an additional gap for these models.

Model	A DIMENSION	MAX. LOADING CAPACITY
USS 95 DTKL	360	30 Kg.
USS 60 DTKL	345	20 Kg.

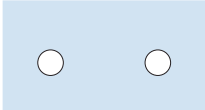

2 holes with the diameter of 7 mm and depth of 40 mm are drilled on a surface, the solidness of which is ensured, on the A axis which you have determined according to the device.

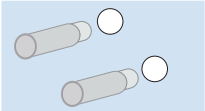

Expansion bolt of 8 mm is driven into both holes tightly.

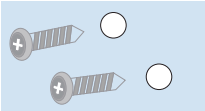

2 screws of 4,8x38 YSB DIN NO:7981 are inserted into the expansion bolt that are driven tightly.



It is necessary to leave the distance of 2-3 mm between the head of the screw and the expansion bolt and for inserting the hanging plates behind the cooler to the screws.
Note: Leaving the screws excessively long may cause detachment of the cooler.

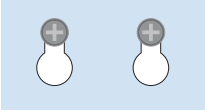

Make sure that the slot hole on the hanging plate behind the cooler fits securely. While hanging the device onto the expansion bolt, you can align the screw and slot hole from the hole on the side surface of the hanging plate.

C -INSTALLATION OF YOUR COOLER.

Installation

Before positioning, remove and disassemble all packaging materials and bottom wooden pallet of the product. (It may be necessary to lift the cooler for removing the bottom pallet).

Insert the replacement parts inside your product according to the installation instructions. Only use genuine Uğur spare parts.

Inauthentic spare parts may constitute danger for you and damage your product.

Place the product anywhere you desire. Consider the placement rules written in the manual while positioning the product.

Balance your product in width and in depth by means of a water gauge. Perform balancing operation by using adjustable feet at the bottom front of your cooler. (Picture 9)

In models with wheels (optional), wheel brake (optional) must be locked or if there is no wheel brake, it must be guaranteed that the device will not move after the positioning of the product.

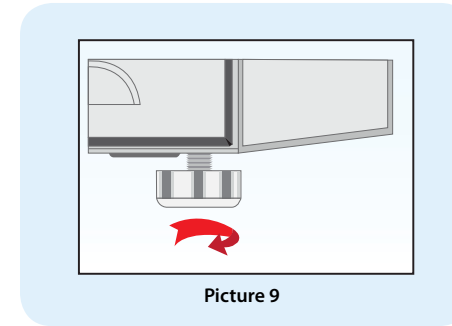

C-INSTALLATION OF YOUR COOLER.

Electric Connection Rules

The product will start when you insert the plug into the outlet as shown in picture 10.

WARNING!

- It is forbidden to insert the plug into multiple socket and to use extension cord. (Picture 11)
- There is no separate on-off switch on your product.
- Do not contact the cables of your product, which are connected to the mains, to hot surfaces.

The outlet you will use must be grounded. Furthermore, the outlet to be used must have the resistance of at least 10-16 A and be protected with a suitable fuse. Definitely take assistance from our technical service or a competent electrician with regards to the fuse that should be present on the mains where the outlet is connected.

Mains voltage and frequency must be same with the value written on the label inside your product. If your mains voltage is extremely below or above the value indicated, definitely supply demanded voltage by using a voltage regulator. You can get assistance from an expert electrician with this regard.

Do not place your product's cord onto passageways. This may cause you to get injured and damage your cooler. (Picture 12)

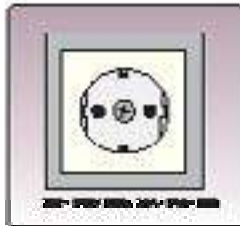

Picture 10

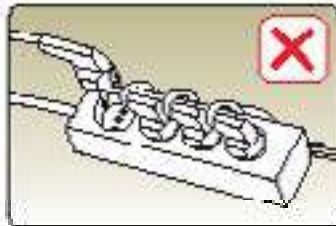

Picture 11



Picture 12

D-USING YOUR COOLER

Start-up

WARNING!

- This operating manual applies for various device models. Hardware scopes of the models may vary. There may be differences in the pictures.
- Clean inside and all accessories of your product before the first start up (see page 23).
- If your product has been shaken so much during the transportation and positioning, wait for one (1) hour without running your cooler. Thus, the compressor oil, which may enter into the system, will return back. You may damage the compressor if you run it without considering this.
- Insert your product's plug into an outlet with alternative current of 220-240V/50 Hz only, which has been installed according to the regulations. (Picture 13)
- You will hear a slight sound from the compressor when your product is running.
- The fan inside your product will stop when you open the door of your refrigerator.
- If the lights of your product are not on, set the 0-1 switch under the canopy to position 1. (Picture 14-15)



Picture 13



Picture 14



Picture 15

Setting internal temperature of your product

Temperature settings of your product have been set in our factory in a manner that operates under the most suitable conditions.

Protection temperature of the food are observed from the thermometer (optional) equipped in your cooler and set via the thermostat. (Picture 16) However storing the factory settings is the most appropriate one.

Internal temperature of your cooler can be adjusted by rotating the thermostat button (Picture 17). When the thermostat is at position "7", internal temperature of the refrigerator will be at the lowest level. Internal temperature of your product can be set between +1 and +10°C.

WARNING!

Thermostat operation is different only in USS 374 DTK SRP Vine Cooler. In these products, you will get the coolest temperature when the thermostat is set as position 1 and highest temperature when it is set as position 7.

If your wine cooler is equipped with a fan;

The temperature inside the cooler in position 1 is about 10°C.
The temperature inside the cooler in position 7 is about 18°C.

If your wine cooler is not equipped with a fan and static;

The temperature inside the cooler in position 1 is 4-5°C
at the bottom, 10°C in the medium and 15°C in the top section.
The temperature inside the cooler in position 7 is 15°C
at the bottom, 18°C in the medium and 22°C in the top section.

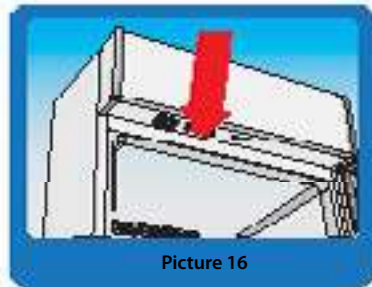

Picture 16









Picture 17

Using digital thermostat

If the product you've purchased is equipped with a digital thermostat, please pay attention to the following matters. Digital thermostats are factory set and do not require any setting. You can change the thermostat setting as shown below.

Digital thermostats contain many programs (such as eco mode, night mode). If you believe that there is a problem in your product related to the operation or cooling, please consult to authorized service.

Error codes given by the digital thermostats are under the troubleshooting title. When you encounter these error codes, stop thermostat alarm and call Authorized Uğur Service.

 Turns on/off your cooler.	 Manuel defrost.
  Mutes alarm.	   Shifts to economic mode and night mode.

For Carel Thermostat;



Temperature is increased by pressing this button after setting the device temperature.

When setting the device temperature. It is activated when the set button is pressed for 2-3 seconds.

Temperature is decreased by pressing this button after setting the device temperature.

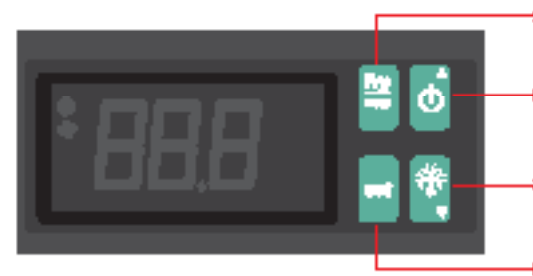

Emergency key. Only used by service personnel.

Power on/off function. Temperature is increased by pressing this button after pressing set button simultaneously.

Manual defrost of the product. Temperature is increased by pressing this button after pressing set button simultaneously.

When setting the cooler temperature. It is activated when the set button is pressed for 2-3 seconds.

D- USING YOUR COOLER

Using digital thermostat

For Dixell Thermostat;

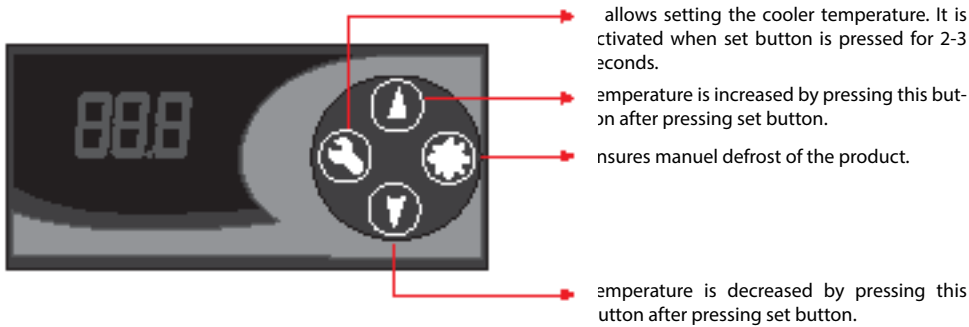
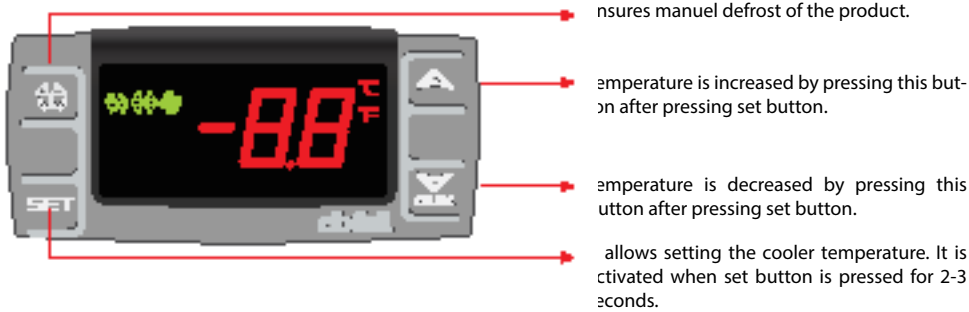

D- USING YOUR COOLER

Loading foodstuff to your cooler

When your product reach to the desired coolness at empty state, you can load it with the types of foodstuff with the examples given in this manual. (If your product is a thermometer installed model, you can control internal temperature of your product from here.)

CAUTION!

- Before loading your cooler with foodstuff, run your cooler empty for two (2) hours.
- Do not place the products that are forbidden to be cooled down into your cooler. Do not defrost frozen products in your cooler.
- Leave the gap of at least two (2) cm between the foodstuff loaded and the upper shelf for the air circulation.
- Do not load over the loading line.
- Some models of USS 374 DTKGD vine coolers are without fan and temperature difference occurs between the upper and lower parts. This requires loading to the upper or lower part depending on the type of the wine. In the models equipped with inner fan, a homogenous air temperature is created at every point of the product depending on the thermostat level.

Shelf carrying capacities of the products are given below:

MODEL	MAX. SHELF CARRYING CAPACITY	MODEL	MAX. SHELF CARRYING CAPACITY	MODEL	MAX. SHELF CARRYING CAPACITY
USS 60 DTKL	20 kg.	UDD 370 DTK	16 kg.	USS 1000 DSCL	80 kg.
USS 95 DTKL	20 kg.	UDD 370 DTKL	16 kg.	USS 1000 D2KL	80 kg.
USS 100 DSCL	20 kg.	MAX. RAF T	16 kg.	USS 1200 DSCL	80 kg.
USS 190 D2KL	20 kg.	USS 380 DTKL	35 kg.	USS 1200 D2KL	80 kg.
USS 220 DTK	35 kg.	USS 748 D2KL	35 kg.	USS 1800 D3K	35 kg.
USS 220 DTKL	35 kg.	USS 440 DTKL	55 kg.	USS 1800 D5K	35 kg.
USS 275 DTK	35 kg.	USS 690 DTKL	55 kg.		
USS 275 DTKL	35 kg.	USS 690 DTKL	55 kg.		
USS 300 DTK	35 kg.	USS 690 DTKL LCD	55 kg.		
USS 300 DTKL	35 kg.	USS 691 DTKL LCD	55 kg.		
USS 374 DTK	35 kg.	USS 700 DTKL	55 kg.		
USS 374 DIK	35 kg.	USS 1100 DSC	80 kg.		
USS 374 DTK ŞARAP	35 kg.	USS 1100 D2KL	80 kg.		
USS 374 DTKL	35 kg.	USS 1100 DSC	80 kg.		
UDD 370 DTK BK	16 kg.	USS 1100 D2KL	80 kg.		

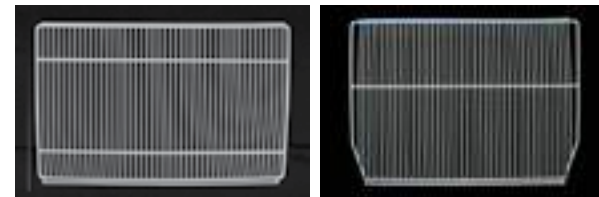

D- USING YOUR COOLER

Defrost function

Your product has automatic defrost function. Your show case will melt frost automatically when it is necessary to defrost while running

Although your product automatically prevents frost deposit, frost deposit ratio may increase due to high temperature and humidity as well as frequent use of the device. Running period increases as the frost deposit increases. That also increases the energy consumption. In such cases, stop your product and ensure melting of the frost.

DO NOT FORGET!

An evaporator without frost will always run with high efficiency

Water from the evaporator drops onto the drop tray at compressor section. Even though hot gas evaporates water here, it will be better to check and clean once a month

Shutting down your product

- Transfer the foodstuff inside your product to a convenient place.
- Unplug your product. (Picture 18)

If your product will not be used for a long time, apply following considerations;

- Clean your product. Otherwise the humidity on the wall may cause darkening of the internal surface.



Picture 18

CAUTION!

If your product will be stored at an indoor place after shutdown;

- Do not cover it with plastic sheets. Plastic will cause smell and sweating of your product as it does not breathe. Corrosion may be seen as the result of sweating.
- Smell formation may occur in cases where you fail to store your product with the door open.

E- CLEANING, MAINTENANCE AND TRANSPORTATION OF YOUR COOLER

CLEANING

Cleaning of your device is composed of two stages, which are the internal cleaning and external cleaning.

Following warnings must certainly be abided before start cleaning.

CAUTION!

- Unplug your cooler before every cleaning.
- Always wear protective gloves during cleaning and maintenance. This will protect you from injuries.
- Never use abrasive and scratching substances (flammable and sparkling, solvent like gasoline, thinner, acid) as cleaning agents. Never use flowing and pressurized water for cleaning.

Internal cleaning

Transfer the foodstuff inside your product to a convenient place.

Before the internal cleaning, wait until the temperatures of the internal parts of your product reaches to the ambient temperature.

Always wear protective gloves during cleaning and maintenance. This will protect you from injuries.

Remove the accessories from inside.

Perform cleaning with a soft cotton cloth and warm soapy water or by using the cleaning agents recommended by Uğur Soğutma A.Ş.

Dry with a dry cotton cloth. Products, which are not dried, may darken in time.

Make sure that no wet or humid area is left in the internal section after cleaning.

You can reload your product two (2) hours after running your product as stated in this manual.

External cleaning

Clean with a cotton cloth and warm soapy water.

Prevent penetration of cleaning water into the front control panel and lighting section while cleaning.

Clean the door gasket by using clean soapy water only.

SUGGESTION

You can use Uğur branded cleaning agents, which you can get from Authorized Uğur Services for internal and external cleaning of your device.

E- CLEANING, MAINTENANCE AND TRANSPORTATION OF YOUR COOLER

Transportation of your product

Unplug your product from the grounded outlet.

Carry out defrost operation.

Carry your product at normal using position. Do not carry horizontally, vertically, tilted or with the door open.

Protect your product from the impacts while carrying. Do not carry your product when it is plugged in or full.

In order not to cause any accident and for preventing the product to get damaged by falling or sliding, secure your product to the vehicle during the transportation.

NOTE

Pay attention to the following considerations if you do not use your product for reasons such as vacation, trip etc..

If you do not use it for a short time:

Leave your product in operating state.

If you do not use it for long time and want to shut it down:

Consume the foodstuff inside your product and empty it.

Unplug the power cord from the outlet.

Apply defrost and internal cleaning steps in this manual.

Dry inside of the product thoroughly. Darkening may occur in the product which is not dried.

Leave the product door open.

F- THINGS THAT MUST BE DONE BEFORE CALLING AUTHORIZED SERVICE

Troubleshooting

The failures and solutions stated in this section can be performed easily by yourselves and always consult to an Authorized Uğur Service if these suggestions do not solve your problem.

CAUTION!

- Intervention to any failure that may occur in your product must be carried out by Authorized Uğur Service.
- Any intervention that may be done by you may harm you, your employee or customer, invalidate the product guarantee and cause material damage (fire etc..).
- In case of any failure, consult to Uğur Customer Care or Authorized Uğur Service.

Troubleshooting	Possible Solution	Result
Cooler is not working. (No sound or only fan sound comes from the product.)	It may be due to the thermostat. Not plugged in. The fuse may be blown or broken down. Condenser lamella may be obstructed or get dirty.	It will run again when reached to the suitable temperature. Insert the plug properly. Consult to an Authorized Uğur Service or a competent electrician. Clean the condenser lamellas.
Device internal temperature is high.	External ambient temperature is very high or wrong thermostat setting. Very close to the back wall, ventilation shutters are obstructed or its front is prevented. It may have been exposed to excessive external wind. Condenser lamellas are very dirty.	Move the cooler to a place where the external temperature is lower. Adjust to the stated gap. Clean in front of the ventilation shutters. Prevent the wind. Clean the condenser lamellas.
Device internal temperature is very low.	Wrong internal thermostat setting.	Re-set the thermostat.
Lamps of the cooler do not light or only one of them lights.	Lamps are turned off. Bulb has blown or starter failure.	Turn-on the lamps. Replace failed part.
High degree of sweating on the glass inside the device.	Water discharge hole may be obstructed when sweating is seen inside the cabin. In glass sweating on the other hand, current external ambient humidity is over 65%.	Clean water discharge hole. With regards to the high humidity, you can move your cooler to an environment with less humidity.
Bad smell coming from the bottom part of the cooler.	Lower water discharge tray is dirty. (For some models only)	Clean the water discharge tray.

Power values of the bulbs and leds used in your products are stated in the section where they are inserted and may vary in products. Only Authorized Uğur Service can intervene bulbs and leds used in your products.

F- THINGS THAT MUST BE DONE BEFORE CALLING AUTHORIZED SERVICE

Digital thermostat failures

Alarm signals for Dixel thermostat;

MESSAGE	REASON	PROCEEDINGS TO BE FOLLOWED
P1	Room sensor failure	Check the sensor connection
P2 sen	Evaporator sensor failure	Check the sensor connection before replacing the sensor.
HA pa-	Maximum temperature alarm	Check compressor operation and relevant parameter values.
LA pa-	Maximum temperature alarm	Check compressor operation and relevant parameter values.
EA	External alarm	Alarm stops automatically when digital entry is deactivated.

Alarm signals for Carel thermostat;

MESSAGE	REASON	PROCEEDINGS TO BE FOLLOWED
EO	Control sensor 1 failure (Control)	Check the sensor
E1	Control sensor 2 failure (Defrost)	Check the sensor and d0=0/1/4,F0=1
E2	Control sensor 3 failure (Condenser)	Check the sensor and whether it is (A4=10)
IA	External alarm	Check external alarm outlets or A4 and A7 parameters.
dOr	Open door alarm	Check that the door is closed or A4 and A7 parameters.
LO	Low temperature alarm	Alarm will be turned-off automatically when the temperature returns to the set value range. Also check the set value.
HI	High temperature alarm	Alarm will be turned-off automatically when the temperature returns to the set value range. Also check the set value. Check whether the cooling system runs properly.
EE/Eer	Unit parameter failure	Check the parameters.
EF	Operating parameter failure	Check dT,dP and d4 parameters; defrost effect. Alarm will be closed automatically when defrost operation finishes.
ED	Defrost completed out of its time	dT, dP ve d4 parametrelerini; defrost etkisini kontrol et. Defrost işlemi normal olarak bittiğinde alarm kapanacaktır.

Setting the digital thermostat values other than the factory settings are completely under the user's responsibility. Our company shall not be held responsible for the material and moral losses that may arise in connection thereto.

F- THINGS THAT MUST BE DONE BEFORE CALLING AUTHORIZED SERVICE

Alarm signals for Elstat thermostat;

Alarm signals for Elstat thermostat;

MESSAGE	REASON	PROCEEDINGS TO BE FOLLOWED
=	Door is open	Check the product's door.
rSF	Cooling system failure	Check compressor operation and relevant parameter values.
PF1 PF2	Sensor failure Cabinet and condenser sensor	Check the sensor Check parameter values.

Setting the digital thermostat values other than the factory settings are completely under the user's responsibility. Our company shall not be held responsible for the material and moral losses that may arise in connection thereto.



Fabrika : Yeni Sanayi Mahallesi Devlet Karayolu
Caddesi No: 127/C Nazilli - AYDIN
Tel: 0.256 316 10 00 (pbx) Faks : 0.256 316 10 31

Bölge Müdürlüğü: Mahmutbey Mahallesi Peyami
Safa Caddesi Doğukan Sokak. Uğur Plaza No: 9
Bağcılar - İSTANBUL
Tel: 0.212 624 32 28 (5 Hat) Faks: 0.212 598 94 26

ugur@ugur.com.tr - www.ugur.com.tr