

# **BRAVILOR BONAMAT**

## **WHK**



User manual  
Mode d'emploi utilisateur  
Gebraucher Handbuch  
Gebruiksaanwijzing  
Användarmanualen  
Brukerhåndbok  
Brugsanvisningen  
Käyttäjän käsikirja  
Manual del usuario  
Manual do utilizador  
Manuale per l'utente  
Εγχειρίδιο χρήσης  
Příručka pro uživatele  
Podręcznik użytkownika  
Manualul utilizatorului  
Руководство  
пользователя  
Kullanıcı kilavuzu  
使用手册  
ユーザーマニュアル  
사용자 설명서

700.403.742B



Model nr.: • WHK-003

[www.bravilor.com](http://www.bravilor.com)

English  
Français  
Deutsch  
Nederlands  
Svenska



Norsk  
Dansk  
Suomi  
Español  
Português

Safety book  
Sommaire des sécurités  
Sicherheitsvorschriften  
Veiligheidsboek  
Säkerhetsföreskrifter



Sikkerhetsbok  
Sikkerhedsbog  
Turvallisuusohjeet  
Libro de seguridad  
Instruções de segurança

Installation  
Installation  
Installation  
Installieren  
Installation



Installasjon  
Installation  
Asennus  
Instalar  
Instalação

Cleaning  
Nettoyage  
Reinigung  
Schoonmaken  
Rengöring



Vasking  
Rengøring  
Puhdistus  
Limpiar  
Limpeza

Hot surface  
Surface chaude  
Heiße Oberfläche  
Heet oppervlak  
Het yta



Varm overflate  
Varm overflade  
Kuuma pinta  
Superficie caliente  
Superfície quente

Moist cloth  
Chiffon humide  
Feuchtes Tuch  
Vochtige doek  
Fuktig trasa



Fuktig klut  
Fugtig klud  
Kostea pyyhe  
Trapo húmedo  
Pano húmido

Italiano  
Ελληνικά  
Česky  
Polski  
Română



Русский  
Türkçe  
中國語文  
日本語  
한국어

Prescrizioni di sicurezza  
Εγχειρίδιο Ασφάλειας  
Bezpečnostní kniha  
Wskazówki  
bezpieczeństwa  
Carte instructaj



Руководство по безопасности  
Güvenlik kitabı  
安全手冊  
安全マニュアル  
안전 매뉴얼

Installazione  
Εγκατάσταση  
Instalace  
Instalacja  
Operare



Устанавливать  
Yerleştirme  
安裝  
設置  
설치

Pulizia  
Καθάρισμα  
Čištění  
Czyszczenie  
Curățare



Чистка  
Temizleme  
清潔的  
クリーニング  
청소

Superficie calda  
Καυτή επιφάνεια  
Horký ovrch  
Gorąca powierzchnia  
Suprafață fierbinte



Горячая поверхность  
Sıcak yüzey  
表面熱  
溫液  
뜨거운 표면

Panno umido  
Υγρό πανί  
Vlhká látka  
Wilgotna szmatka  
Cârpă umedă



Влажная салфетка  
Nemli bez  
潮濕的布  
高温面  
촉촉한 천

*First read the safety instructions*

*Tout d'abord lire les mises en garde et directives de sécurité*

*Lesen Sie zuerst die Sicherheitsbestimmungen*

*Lees eerst de veiligheidsvoorschriften*

*Läs först säkerhetsinstruktionerna*

*Les først sikkerhetsinstruksjonene*

*Læs først sikkerhedsanvisningerne*

*Lue ensin turvaohjeet*

*Lea en primer lugar las instrucciones de seguridad*

*Leia em primeiro lugar as instruções de segurança*

*Leggere prima le norme di sicurezza*

*Διαβάστε πρώτα τις οδηγίες ασφαλείας*

*Nejprve si přečtete bezpečnostní pokyny*

*Najpierw zapoznaj się z instrukcjami bhp*

*Mai întâi citiți instrucțiunile de siguranță*

*Сначала прочитайте правила техники*

*безопасности*

*Önce güvenlik talimatlarını okuyun*

*首先阅读安全须知*

*最初に安全上の注意をお読みください*

*먼저 안전 지침을 읽는다*

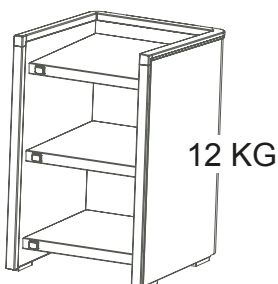



1.



2.

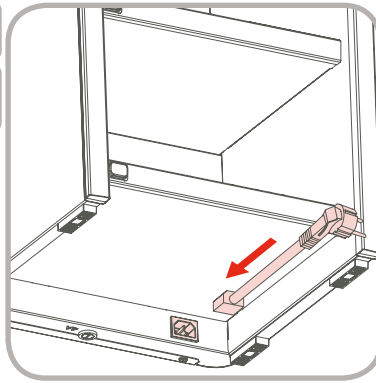

3.

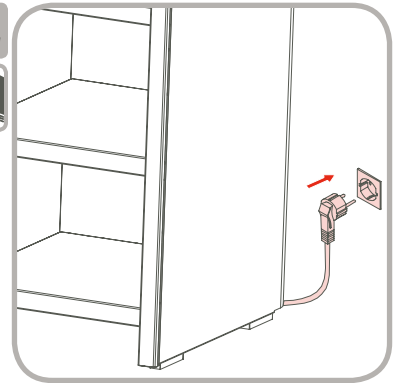

4.

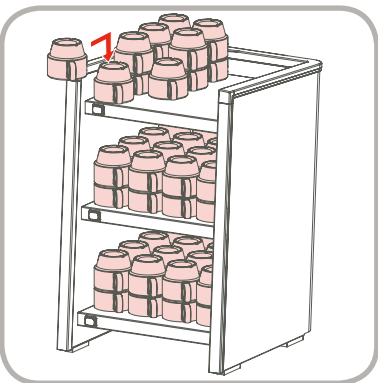

5.



1.



2.

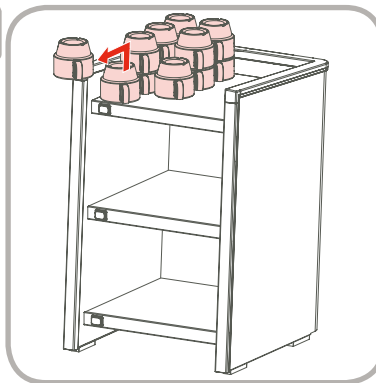

3.

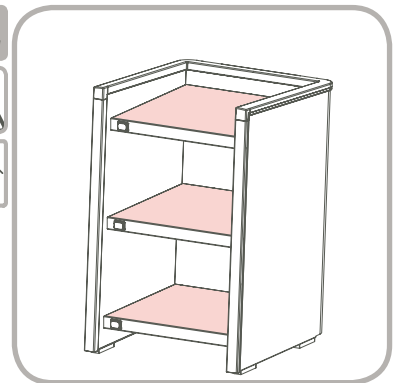

4.

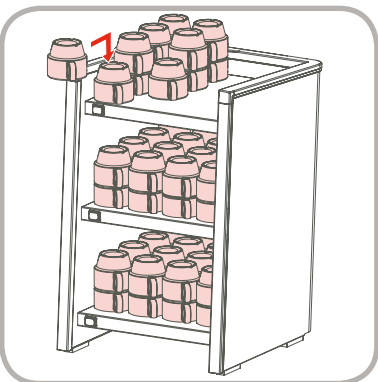

5.

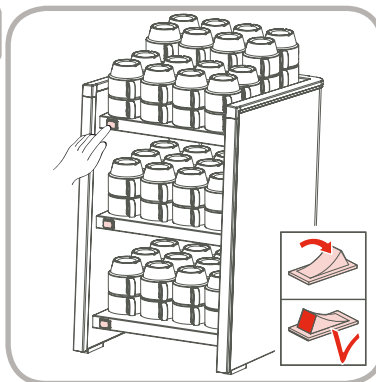



**/// BRAVILOR  
BONAMAT**



©  
05-2015  
VHH

