

CARIMALI

USER'S MANUAL
Translation of original instructions



DIVA *PRO*

CONTENTS

GENERAL SAFETY WARNINGS	4		
HANDLING AND STORAGE	8		
PACKAGING CONTENTS	9		
PRIOR CHECKING			
AFTER RECEIPT	9		
POSITIONING	10		
POWER MAINS CONNECTION	10		
WATER MAINS CONNECTION	11		
MILK CIRCUIT CONNECTION .	12		
Boiler filling	12		
RESIDUAL RISKS	12		
IDENTIFICATION	13		
1 INTRODUCTION	14		
1.1 USED SYMBOLS	14		
1.2 USER TYPES	14		
1.3 INTENDED USE	15		
1.4 REASONABLY FORESEEABLE MISUSE	15		
2 DESCRIPTION OF THE MACHINE	16		
2.1 GENERAL DESCRIPTION OF THE MACHINE	16		
2.2 DESCRIPTION OF PUSH-BUTTON PANEL	17		
2.3 DISPLAY DESCRIPTION	17		
3 TECHNICAL CHARACTERISTICS	18		
3.1 TECHNICAL DATA	18		
3.2 OVERALL DIMENSIONS	19		
4 INSTRUCTIONS FOR USE	21		
4.1 SWITCHING ON	21		
4.2 BOILER FILLING	21		
4.3 BOILER HEATING	21		
4.4 MACHINE READY	22		
4.4.1 Cup warmer / led	22		
4.4.2 Washes	22		
4.4.3 Information	22		
4.5 INITIAL WASH SUPPLY CIRCUIT	23		
4.6 DRINK DISPENSING	23		
4.6.1 Coffee dispensing	23		
4.6.2 Hot water dispensing	24		
4.6.3 Steam supply (Cool Touch steam wand) ...	24		
4.6.4 Steam supply (Barman steam wand)	25		
4.6.5 Milk dispensing (LM version)	25		
4.6 TECHNICAL MENU	26		
4.6.1 Info Reset	26		
4.6.2 System Manager	27		
4.7 SWITCHING OFF	30		
5 ROUTINE MAINTENANCE	31		
5.1 EXTERNAL CLEANING	33		
5.1.1 Cleaning the display	33		
5.1.2 Cleaning of chrome-plated surfaces	33		
5.1.3 Cleaning of machine surfaces	33		
5.2 CLEANING THE SUPPORT SURFACE	33		
5.3 COFFEE GROUP WASHING	34		
5.4 WASHING THE MILKER	35		
5.4.1 Manual washing of the milker	36		
5.5 STEAM WAND WASHING	37		
5.6 WASHING THE BARMAN STEAM WAND	38		
5.7 HOT WATER SPOUT WASHING	39		
5.8 CLEANING OF THE SPRAYHEAD, FILTER HOLDER AND FILTER	39		
6 TROUBLESHOOTING	41		
6.1 HOW TO DETECT AN ERROR.	42		
6.2 OPERATING ALARMS	42		
7 DISPOSAL	47		

GENERAL SAFETY WARNINGS

This manual is an integral part of the machine.

Read carefully the instructions and warnings contained in this manual since it provides important indications concerning the installation, use, and maintenance of the appliance.

For specific warnings concerning the positioning, installation, power and hydraulic connection, and the machine use and maintenance, refer to the related paragraphs in this manual.

The machine is intended for professional use. Always strictly follow the instructions contained in this manual and keep it in a safe, dry place for future reference.

The machine must be used by skilled operators according to the instructions provided in this manual. Any other use is considered as improper.

The weighted, equivalent sound pressure level is below 70 dB.

After unpacking the machine, verify its integrity. In case of damage or doubts about the packaging contents, please contact the Carimali Service Centre.

Handle the machine with care to prevent the risk of impacts or falls that may cause damage.

In case of damage suffered by the room where the machine is installed of an accidental, malicious nature, etc., the machine must be put back into service by qualified personnel or by our Carimali Support Service.



WARNING

In order to ensure the safety of the operator and the machine, it is strictly forbidden to use the machine in a different manner from that indicated in this manual.



WARNING

The Manufacturer declines any liability for damage to things and/or persons arising from an improper use of the machine and/or an incorrect maintenance.



WARNING

Always observe the maintenance plans indicated by the Manufacturer to avoid operating problems such as the release of foreign bodies or residues in the dispensed drink.

Keep packaging parts (box, inner protections, etc.) out of reach of children since they are potential sources of danger. Do not dump those parts into the environment, but dispose them according to applicable regulations.

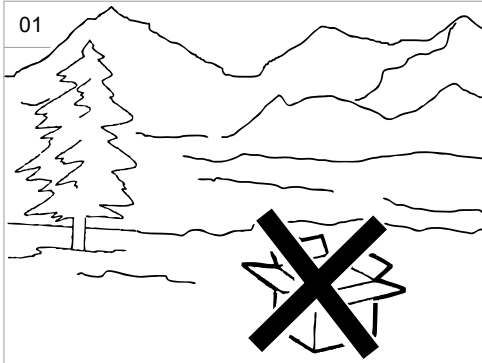

This symbol on the product or on the packaging indicates that the product shall not be treated as household waste, as it shall be delivered to an authorised waste collection point for recycling of electric and electronic devices.



For more detailed information about recycling of this product, contact the local authority, the local waste disposal service.

The equipment is not suitable for the installation in close proximity of water jets or heat sources. Avoid the direct contact with water jets or other liquids also during cleaning.



WARNING

The connection of the single-phase versions of this coffee machine is permitted only in areas that have an electrical system that guarantees a reference impedance adequate to the current consumption of the appliance ($Z_{max} = 0.043 \text{ Ohms}$).

Do not expose the machine to weather conditions (sun, rain, etc.).

Unplug the machine for any intervention of routine maintenance or checking.



WARNING

Do not pull the power cord to unplug the machine from the electric socket.

In case of power cord damage, have it replaced by the Manufacturer, his authorized technical Service Centre or skilled personnel to prevent any risk.

The machine can be used by children aged from 8 years and above and persons with reduced physical, sensory or mental capabilities or lack of experience and knowledge if they have

been given supervision or instruction concerning use of the appliance in a safe way and understand the hazards involved. Children are not allowed to play with the device and to carry out cleaning and maintenance operations without the supervision of trained personnel.

Never touch the hot parts of the machine.

Never touch the machine when hands or other body parts are wet.

Never immerse the machine in water.

The machine delivers high-temperature drinks. Beware of scalding that can be caused by accidental contact with the hot water wand while using the machine.

In case of fault or malfunctioning of the machine, switch it off, unplug it and contact the Carimali Service Centre.

Access to the service areas is restricted to those persons with the relevant practical experience, especially in terms of safety and hygiene.

For repairing, contact only a Service Centre authorised by the Manufacturer and require the use of original spare parts and accessories. Failure to comply with the above regulations could jeopardise machine safety.

For any communication regarding failures or malfunctioning, contact the nearest Service Centre, indicating the model, the type and the serial number of the machine. The data are shown on the opposite data plate.

In case the machine is not used any longer, render it inoperative.



WARNING

If the machine is idle for any period, before putting it back in service, carry out the necessary maintenance operations to allow it to return to work in optimum condition.



NOTE

When required and in case of operations not described in this manual, contact the nearest Service Centre or the Manufacturer.

The Manufacturer reserves the right to carry out technical and aesthetic modifications to the machine and/or this manual for manufacturing or sales reasons without obligation to update the previous versions.

Owing to the above, some pictures contained in this manual may slightly differ from the actual product.

Furthermore, owing to drafting requirements, except in particular cases in which it is necessary to specify the model, this manual will refer to only one machine version.



WARNING

In case of faults caused by the failure to follow the above, the Manufacturer declines any liability for damage caused by non-compliance with the aforesaid provisions.



NOTE

The latest version of the manual can be accessed by registering in the area reserved to customers of the official Carimali website.



NOTE

The machine can only be installed in places where its use and maintenance are reserved for qualified personnel.

HANDLING AND STORAGE

Handle the packaging by means of the apposite carrying handles.



WARNING

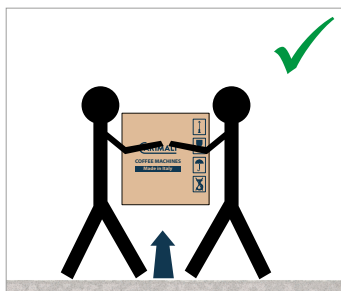
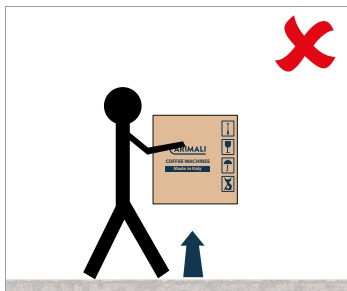

WARNING

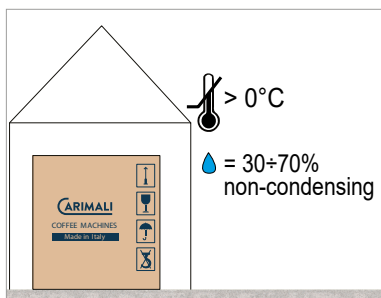

In case of prolonged storage at temperatures below 2°C, the water circuit in the machine must be drained by the Customer. Do not switch the machine on before having reconditioned it for at least 1 hour at a suitable room temperature. If it is installed in areas with room temperature above 30 °C, malfunctioning may occur.

Should you decide not to use the machine any longer, unplug it and then make it inoperative by cutting off the power cord.

PACKAGING CONTENTS

03

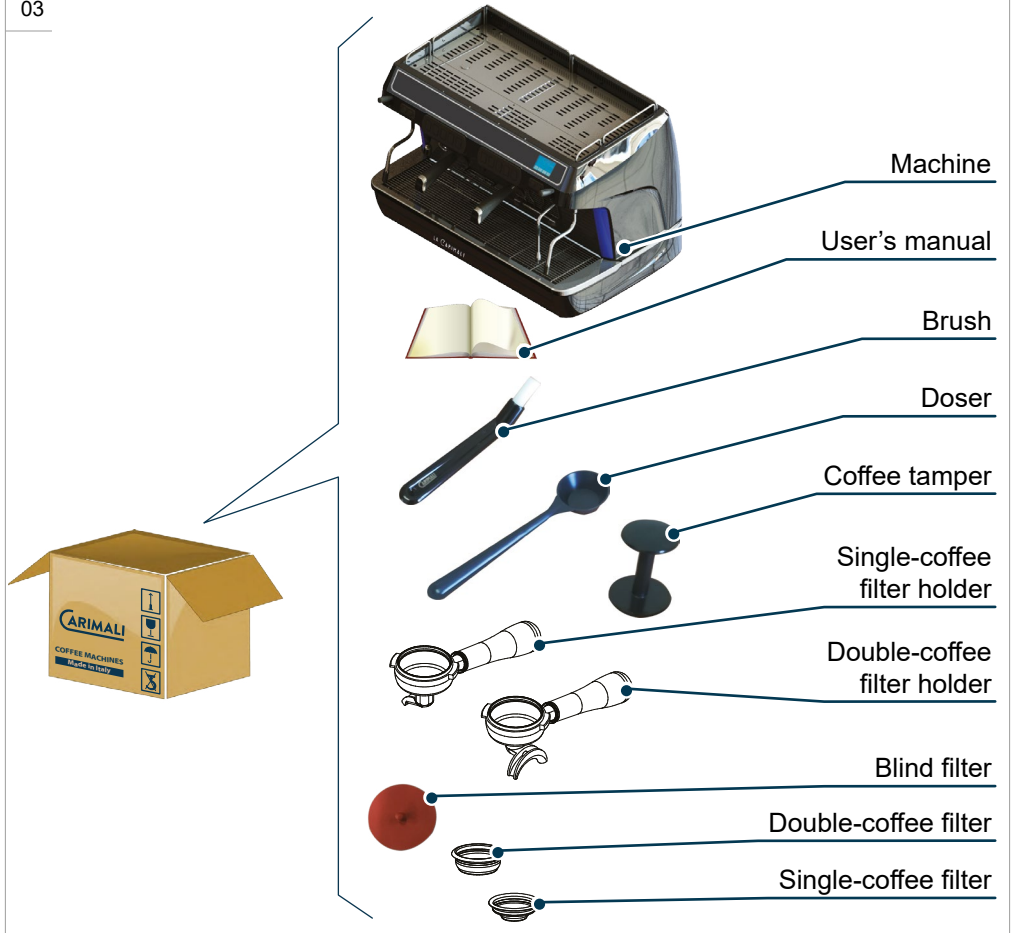

PRIOR CHECKING AFTER RECEIPT

Check the integrity of:

- External and internal packaging;
- External and internal machine parts;
- Accessories supplied.

In case damages or anomalies of the supply are noticed, contact the Manufacturer within 7 days from the purchase.

POSITIONING

The machine must be positioned:

- Indoor with temperature ranging from 5° and 30°C.
- At a minimum distance of 150 mm from walls or other objects, to facilitate ventilation. It is important not to obstruct the ventilation or heat dissipation slots nor to introduce water or liquids of any kind inside.
- Horizontally, on a flat, stable surface, at a minimum height above 700 mm and below 960 mm.

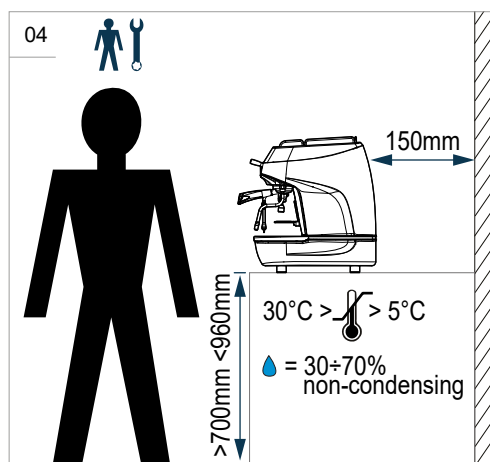

The consents and the procedures described below must be performed by a skilled technician.

POWER MAINS CONNECTION

Before connecting the machine to the power supply, make sure that the power switch is in the “0” position and that the data on the plate correspond to those of the electrical distribution network.

The connection to power mains must be done by a skilled technician in compliance with applicable regulations.

In the case of a machine with direct connection to the electrical panel, where there is no plug, make sure that the connection point incorporates an omnipolar disconnection device suitably sized according to the electrical power of the machine (see plate), with an opening distance of the contacts allowing complete disconnection in over voltage category III.



DANGER

Do not carry out this operation with wet or damp hands.

IT IS IMPORTANT:

- Use the certified Carimali power cord.
- For electric safety of the machine, it is necessary to provide a grounding system complete with a residual current circuit breaker (max IDN = 30mA).
- Do not connect the terminal to the power distribution system as the power cord protection conductor is not considered an equipotential bonding conductor.



WARNING

The Manufacturer declines any liability for failure to comply with the above or for damages caused by the failure to properly ground.

The picture shows an example of a power connection.

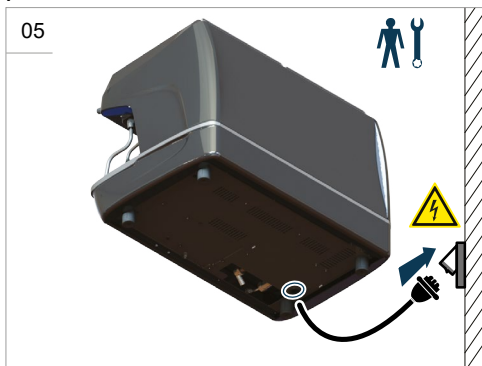

WATER MAINS CONNECTION

The connection to the water mains must be carried out by a qualified technician, in compliance with current regulations.

The picture shows an example of a water connection.

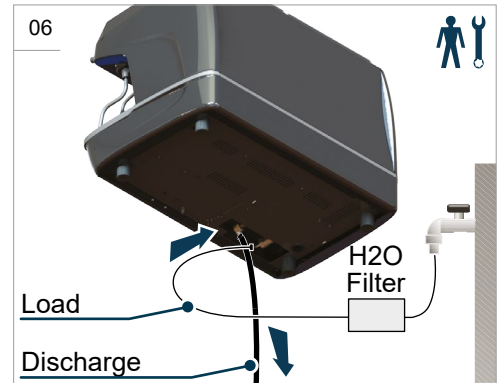

IT IS IMPORTANT:

- Never use the machine without water.
- That the water network pressure does not exceed 6 bar (0.6 MPa). If higher, a pressure reducer must be installed.
- To avoid damage to the hydraulic circuit, the optimal range of water entering the machine from the network is between 7 and 10 French Degrees.
- Use only the tube and fittings supplied with the appliance. It is forbidden to use used parts.
- For the proper use of the machine, install a softener filter with external water non-return system.

MILK CIRCUIT CONNECTION

Milk temperature must be below 4°C.

Connect the milk container to the Milker outlet hose.

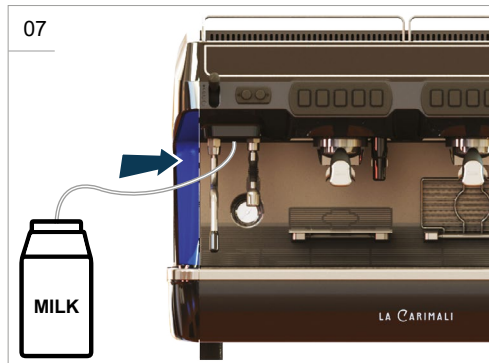

BOILER FILLING

This operation allows filling the hydraulic circuit for correct use of the machine and must be carried out by a qualified technician at the time of installation of the machine, observing the indications given in the Maintenance Manual.

In the next starts, the machine will carry out these operations automatically.

RESIDUAL RISKS

The Manufacturer pre-sets all necessary measures to ensure operator's safety when using the machine.





Anyway, some inconveniences may occur in certain conditions and/or situations.

The causes may be:

- Operator not suitably trained and/or experienced.
- Machine misuse.
- Use of foodstuffs close to their expiry date or already expired.
- Use of non-certified foodstuffs.
- Use of non-original spare parts.
- Unauthorized modifications on the machine.
- Improper maintenance of the machine.

IDENTIFICATION

08

CARIMALI S.p.A. - www.carimali.com Via Industriale, 1 - 24040 Chignolo d'Isola - ITALY		 	MADE IN ITALY 06/2019
TYPE:	s/n XX123456		
MODEL:	DIVA PRO		
INPUT:	400V 3~ 50/60Hz		
NOMINAL POWER:	7000 W		
COFFEE BOILER PRESS:	1,3MPa (13bar)		
INLET WATER PRESS:	min.0,10MPa / max 0,60MPa	 	

1 INTRODUCTION

This manual is a basic component for the use of the machine. It contains instructions and information about handling and usage of the machine in safety.

1.1 USED SYMBOLS



DANGER

It indicates a serious danger for the operator that may cause severe injury or death.



ATTENTION

It indicates a potentially dangerous situation for the operator that may cause severe injury.



WARNING

It indicates a potentially dangerous situation that may cause minor injury or machine damage.



NOTE

It points out notes or operation procedures that helps the operator when using the machine.

1.2 USER TYPES



USER

User in charge only of the simple use of the machine.



FILLING AND MAINTENANCE OPERATOR

User in charge of the filling/emptying of products and consumables, as well as routine maintenance.



QUALIFIED SERVICE ENGINEER

Skilled operator in charge of installation, adjustment, advanced use, and routine maintenance.



CARIMALI SERVICE ENGINEER

Skilled operator authorized by the Manufacturer, in charge of complex operations.

1.3 INTENDED USE

The machine is not intended for outdoor use.

This machine was designed and manufactured for dispensing:

- Coffee;
- Milk;
- Hot water;
- Steam.

The machine is intended for professional use, such as:

- Refreshment areas;
- Service stations;
- Bar;
- Coffee Shop;
- Holiday farms;
- Hotels;
- Motels;
- Bed & Breakfast.

1.4 REASONABLY FORESEEABLE MISUSE



WARNING

In order to ensure safety of the operator and the machine, it is strictly forbidden to use the machine in a different manner from that indicated in this manual.

2 DESCRIPTION OF THE MACHINE

2.1 GENERAL DESCRIPTION OF THE MACHINE

The following image is only an example and may differ in colour from the machine purchased.

The machine can be set up (modular) according to customer's requirements. The main components are listed below. Any configuration might be equipped with more or fewer options according to the customer's needs.

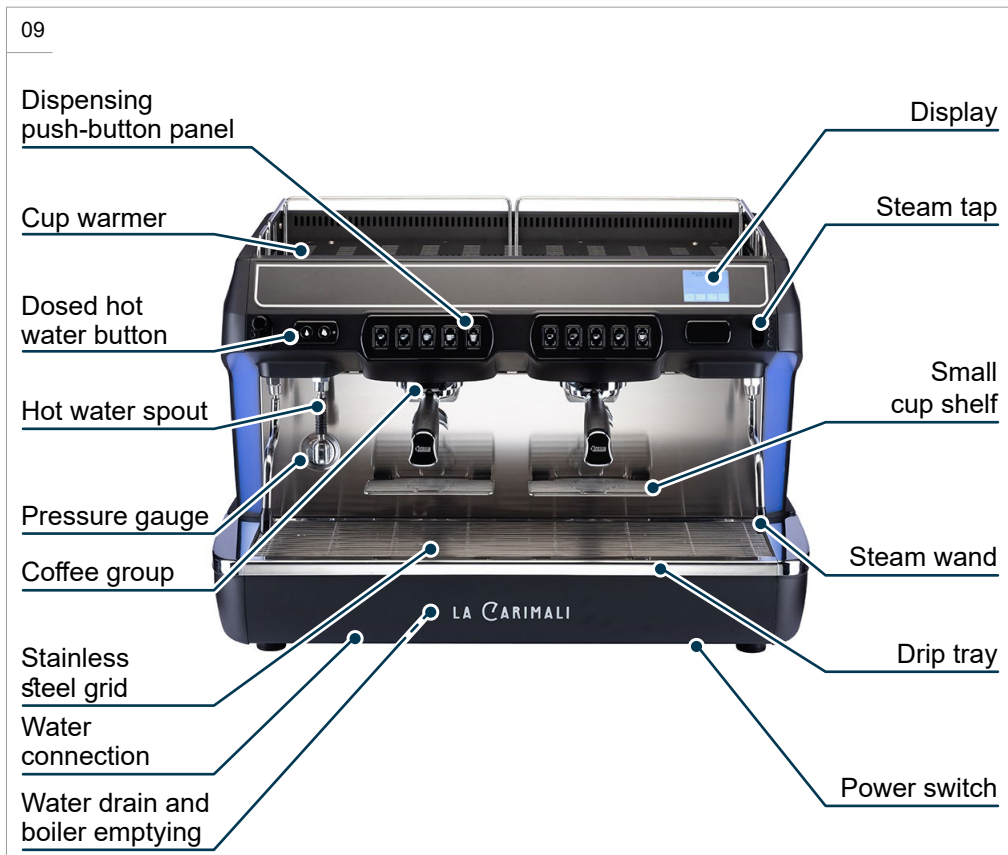

2.2 DESCRIPTION OF PUSH-BUTTON PANEL

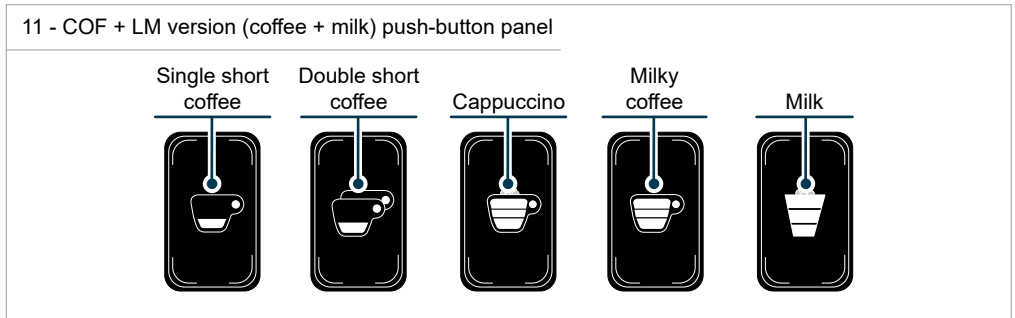
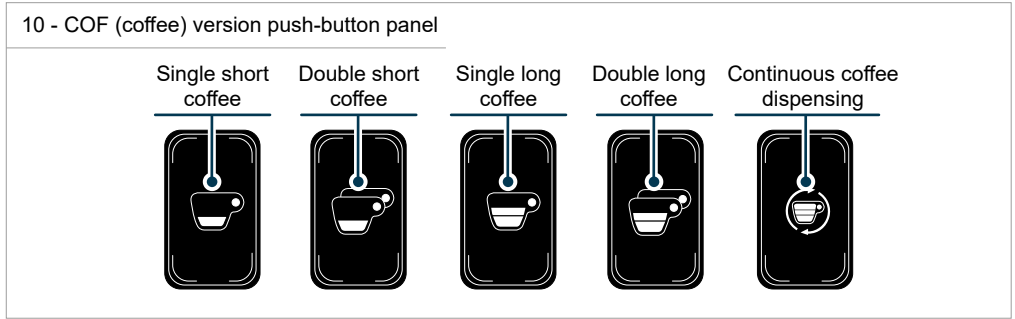

2.3 DISPLAY DESCRIPTION

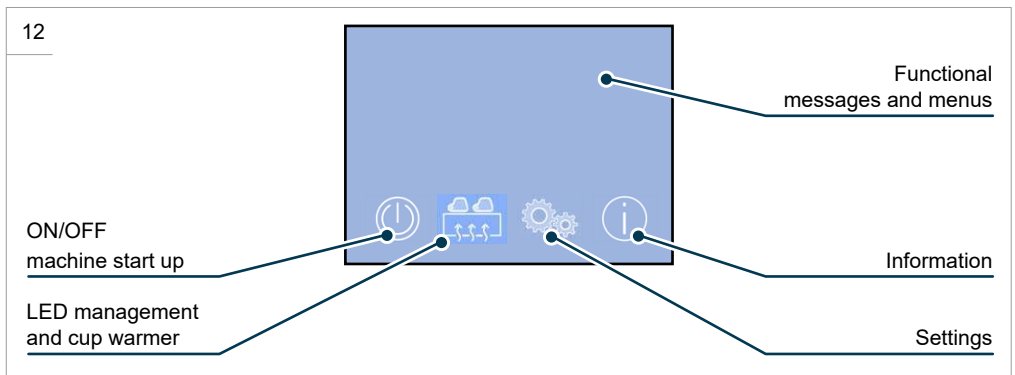

3 TECHNICAL CHARACTERISTICS

3.1 TECHNICAL DATA

FEATURES	2 UNITS	3 UNITS
Power supply	220 / 230 / 240 Vac 1+N 400 Vac 3+N	400 Vac 3+N
Electric frequency	50/60 Hz	
Electric power	5500 W	7000 W
Electric power cup warmer	100 W	150 W
Resistance power coffee unit	160 W	
Steam boiler capacity	11 l	16 l
Resistance power steam boiler	3500 W 4500 W (standard)	6000 W
Volumetric pump	200 l/h - 165 W	
Weight	70 kg	88 kg

3.2 OVERALL DIMENSIONS

13 - Machine version with low units (NT.05537_00_02/2020)

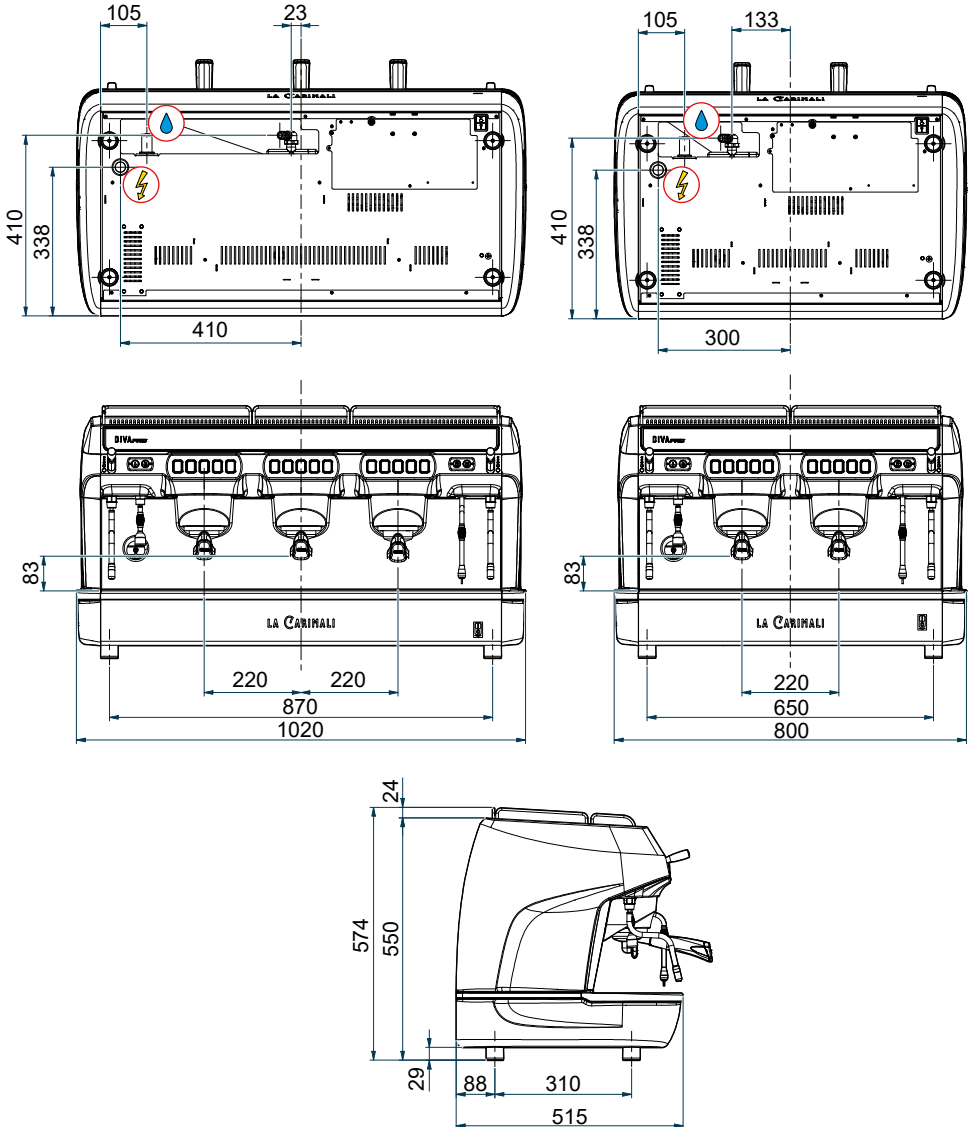

Measurements expressed in mm

14 - Machine version with high units (NT.05538_00_02/2020)

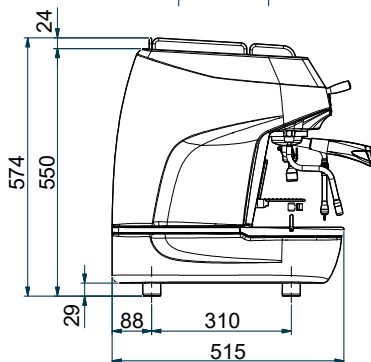
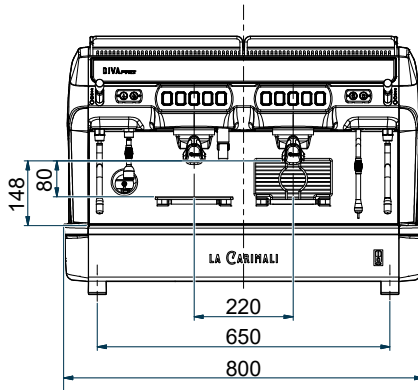
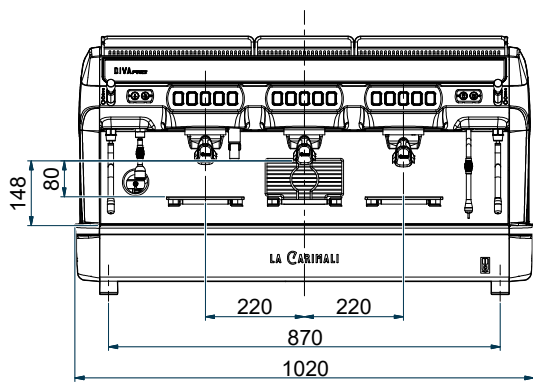
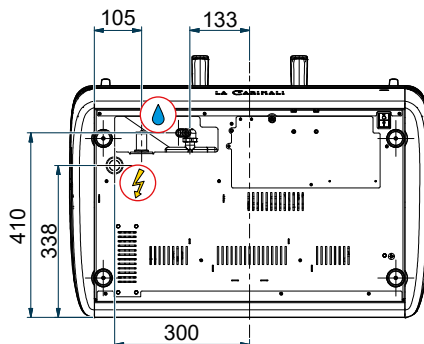
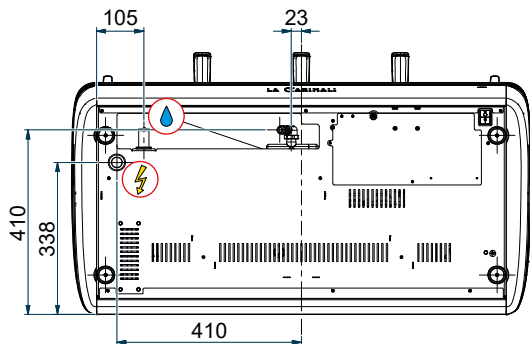

Measurements expressed in mm

4 INSTRUCTIONS FOR USE

4.1 SWITCHING ON

Press the main switch located at the bottom in position “I”.

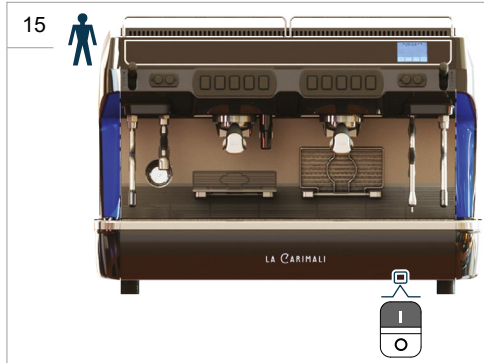

The machine automatically turns OFF and the display shows:

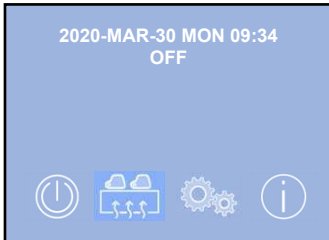

Press  to turn the machine ON.

4.2 BOILER FILLING

When switching on, the display shows the filling phase of the boiler.

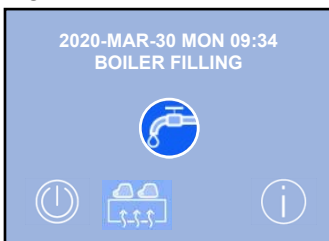

4.3 BOILER HEATING

Subsequently, the illuminated push-buttons go off and the boiler heating phase is displayed.

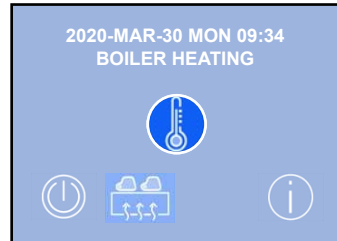

Wait about 15 minutes to heat the boiler before dispensing drinks.



NOTE

COF Version:

During heating, open and keep the steam wand open for a few seconds after the first steam escaping, to expel the air from the boiler.

LM version:

During heating, the milk circuit valve opens from 0° to 95° C and the Barman wand (optional) opens from 50° to 95° C to expel the air from the boiler.

4.4 MACHINE READY

The machine is ready for dispensing when the boiler temperature is reached. The display shows:

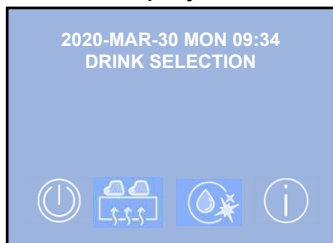

4.4.1 CUP WARMER / LED

Press  to access the settings of the cup warmer and the LEDs.



 : press to turn the side leds on or off.

 : press to access the cup warmer management menu.



 = Maximum temperature

 = Average temperature

 = Minimum temperature

 = Cup warmer off

4.4.2 WASHES

Press  to access the washes menu.

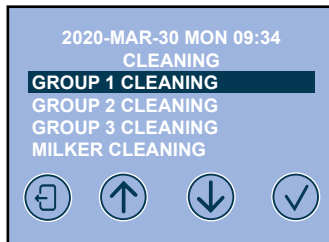

See the relevant chapter for washing procedures.

4.4.3 INFORMATION

The INFO page displays data on temperatures and pressures.

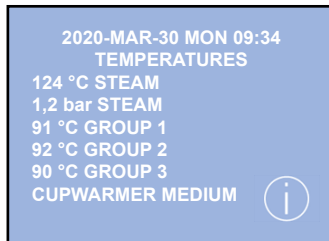

- Steam boiler temperature.
- Steam boiler pressure.
- Unit 1 temperature.
- Unit 2 temperature.
- Unit 3 temperature.
- Cup warmer temperature profile.

4.5 INITIAL WASH SUPPLY CIRCUIT



WARNING

When using for the first time, or after a long period of disuse, wash to eliminate any impurities that may be in the boilers.

16



1. Dispense 1.5 l water from each intake point.
2. Dispense steam for 1 minute.

4.6 DRINK DISPENSING

When the machine is ready, drinks can be dispensed.

4.6.1 COFFEE DISPENSING

Introduce the ground coffee in the filter holder, in quantity and dose according to the desired drink, and insert it in a coffee dispensing unit.

Place a cup under the coffee unit and press the desired dispensing button.

17



The doses must be programmed by a technician during the installation phase, when the staff will also be trained.

15 - Programmed doses



Pressing the  button starts continuous coffee dispensing. Press again when required to end dispensing.



NOTE

There is however a maximum threshold for continuous dispensing (in ml) set by the Manufacturer.



NOTE

Dispensing of the programmed doses can also be interrupted to your liking, by pressing the selected key again.

4.6.2 HOT WATER DISPENSING

Place a container under the hot water wand and press a dispensing button.

18

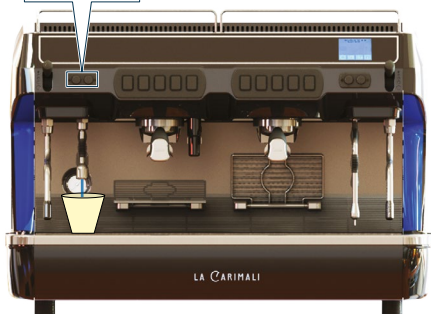

Dispensing ends when the set dose is reached.

To stop dispensing manually, press the button again.

4.6.3 STEAM SUPPLY (Cool Touch steam wand)

Before dispensing steam, open the wand for at least 2 seconds to purge the circuit.

Place a container under the steam wand and lower the corresponding lever to dispense.

19



Do not leave the wand immersed in any liquid.

After dispensing, close the steam wand.

20



To end dispensing:

- Remove the container;
- Clean the wand with a clean, damp cloth;
- Lower and raise the lever a couple of times to purge any milk residue inside the nozzle.

4.6.4 STEAM SUPPLY (Barman steam wand)

Place a container under the steam wand and press a steam button to dispense.



- = Warm milk
- = Frothed milk

Do not leave the wand immersed in any liquid.
Use only the special rubber to move the wand to avoid burns.
 Dispensing ends automatically when the set temperature is reached.

To end dispensing:

- Remove the container;
- Clean the wand with a clean, damp cloth;
- Press and hold one of the steam buttons for a few seconds to purge any milk residue inside the nozzle.

4.6.5 MILK DISPENSING (LM version)

Place a container under the milk dispensing spout and press one of the milk-based beverage dispensing buttons.



- = Cappuccino
- = Milky coffee
- = Frothed milk

The display shows:

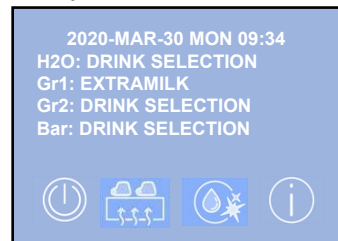

4.6 TECHNICAL MENU

The technical menu can be accessed when the machine is turned off.

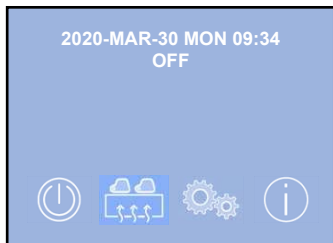

Press  to access the menu. You are prompted to enter the password.

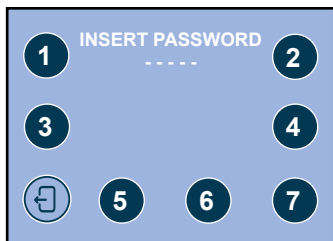

Enter the password **22222** to access the functions:

- Info Reset
- Programming of doses

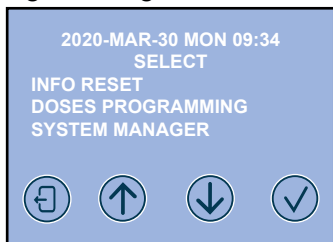

NOTE

From any screen, press  to return to the home menu.

4.6.1 INFO RESET

This menu allows reading the counters.

Select the INFO RESET menu with   and press  to access.

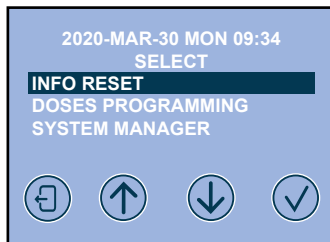

There are two options in the INFO RESET menu:

- Read doses data
- System data (not accessible)

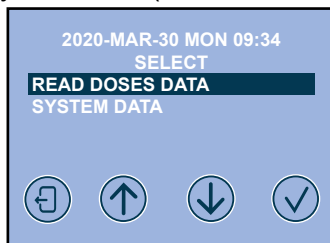

Access **READ DOSES DATA** by pressing  and view the counters.

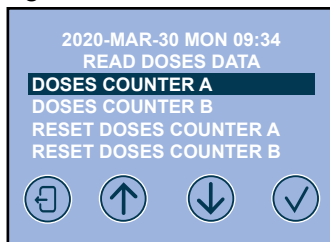

The partial counter reset functions can also be accessed.

The display pages of the A / B counters are identical to each other.

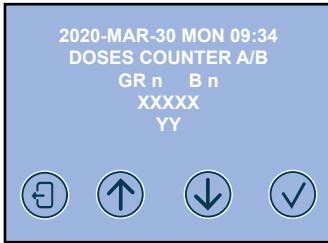

- GR n = unit number
- B n = push-button number
- XXXXX = drink name
- YY = number of drinks

Press the dose keys to view the related counts.

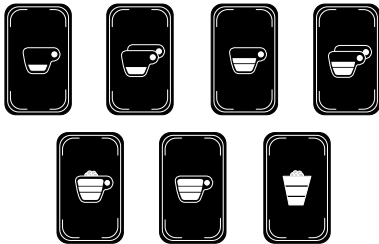

Press  to scroll through the counters:

- X dose total counter;
- Last reset date.
- Extra milk.
- Unit 1 / 2 washing.
- Milker wash.





NOTE

The partial counters reset function requires confirmation by the user.

4.6.2 SYSTEM MANAGER

This menu allows accessing the machine settings.

Select the SYSTEM MANAGER menu with   and press  to access.



The options available in the SYSTEM MANAGER menu are:

- Programming the clock
- Service
- Alarm history
- Display adjustment
- Machine parameters
- Password change
- Actuators test
- Boiler drain
- Machine configuration
- Pre-set configuration data



Programming the clock

Access the CLOCK PROGRAMMING menu.

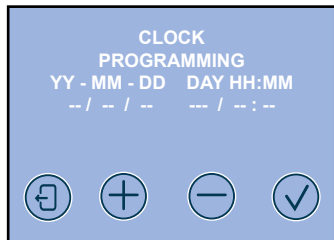

In the menu, scroll the fields to set by pressing .

Set time and date with  .

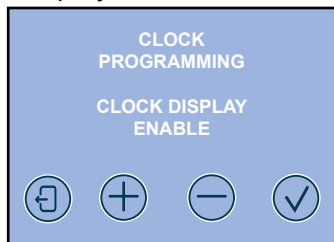

Enable/disable viewing of the clock on the display with  .



Enable/disable automatic switching on of the machine with  .

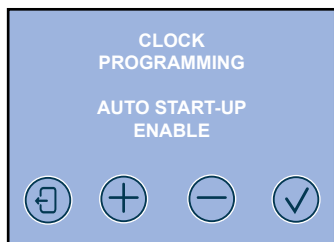

If enabled, the time and days of automatic switching on of the machine must be set.

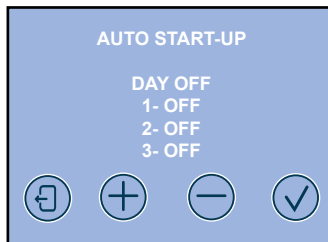
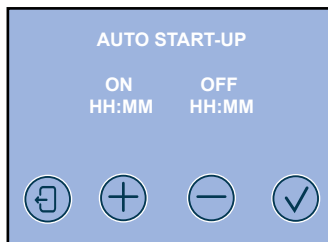

Service

In this programming section, you can only access the Milker wash Time setting.

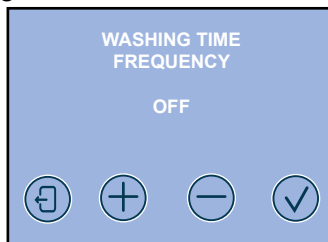

If enabled, the day and washing time must be set.

Alarm History

This section displays the alarms that have occurred on the machine.

Scroll through the list with .

After resolving the alarm, press .

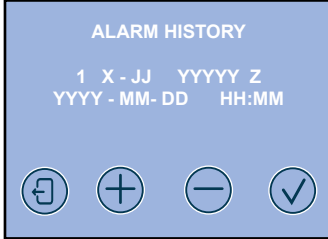

NOTE

The maximum number of alarms saved by the machine in the memory is 10.

Display adjustment

This menu allows setting the display parameters.

Press to scroll through the entries. Set the display contrast with .

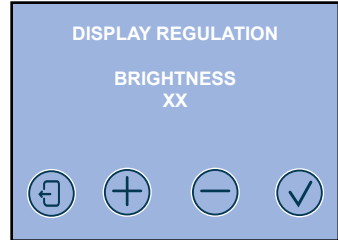

Set the colour profile of the display from 1 to 3 with .

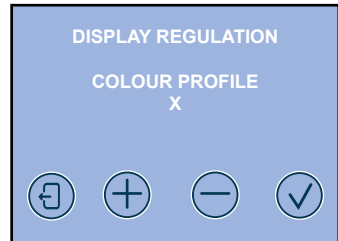

Set the colour of the LEDs by adjusting the shade of red, green and blue (RGB) from 0 to 100 with .

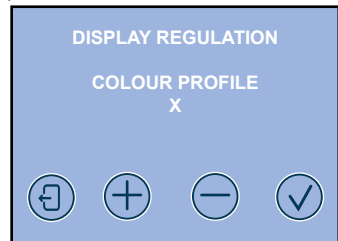

Password change

This menu allows changing the USER PASSWORD.





NOTE

The TECHNICAL level password cannot be changed.

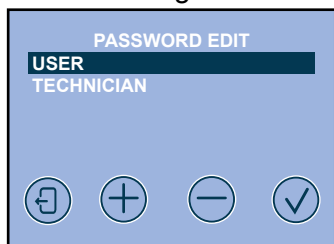
Select the USER entry and press  to access the change.



Set the new password with the   buttons.



NOTE

Set a 5-digit password.
The first digit of the password cannot be changed.

Press  to confirm.

4.7 SWITCHING OFF

To switch the machine off, press and hold  for a few seconds. The display shows OFF.

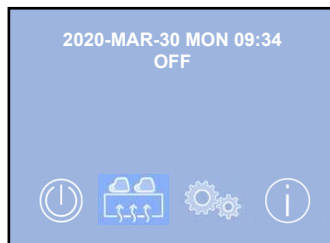

Then press the main switch located at the bottom in position "0".

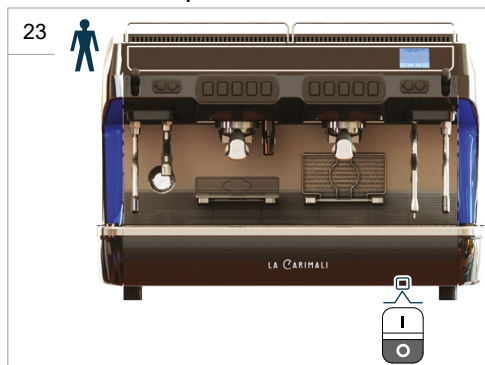

5 ROUTINE MAINTENANCE



DANGER

The intervention of routine maintenance and cleaning must be performed by the operator only after:

- having switched the machine off;
- having disconnected the machine power supply, by unplugging it;
- having awaited the cooling time of the machine.

The operator must always use protective gloves to prevent abrasions.



WARNING

Do not pull the power cord or the machine itself to unplug the machine from the electric power socket.

For the versions of the machine with direct connection to the electrical panel, use the switch on the panel to cut off the electrical power to the machine.



WARNING

Each operation requiring disassembly of the machine parts must be performed by a skilled technician.

OPERATION	TYPE OF OPERATION	FREQUENCY	PARAGRAPH
Display cleaning	Manual	Daily	5.1.1
External cleaning of chrome-plated surfaces	Manual	Daily	5.1.2
External cleaning of machine surfaces	Manual	Daily	5.1.3
Cleaning the support surface	Manual	Daily	5.2
Coffee dispensing group washing	Manual	Daily	5.3
Washing the Milker	Semi-automatic Manual	Daily	5.4 5.4.1
Washing the Steam / Barman wand	Manual	Daily	5.5 5.6
Hot water spout washing	Manual	Daily	5.7
Washing of coffee group spray head and filter holder	Manual	Weekly or when necessary	5.8

5.1 EXTERNAL CLEANING

Do not use solvents, chlorine-based products or abrasive agents to carry out this operation. Do not clean the machine with direct water jets. Never immerse the machine in water or other liquids.

5.1.1 CLEANING THE DISPLAY

Clean the display with a soft, dry cloth.



5.1.2 CLEANING OF CHROME-PLATED SURFACES

For cleaning the chrome-plated surfaces, use a damp cloth, an antistatic cloth or similar. Do not use abrasive agents to carry out this operation.

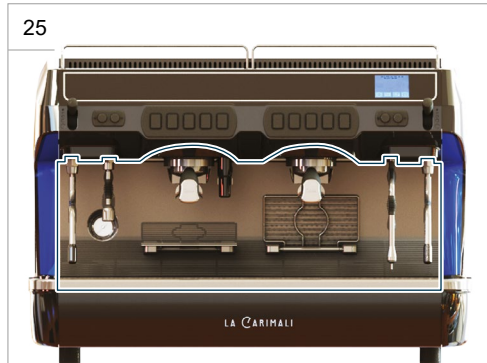

5.1.3 CLEANING OF MACHINE SURFACES

Clean the outside of the machine daily using a cloth moistened with water and then dry carefully.

5.2 CLEANING THE SUPPORT SURFACE

The support surface of the cups must be washed carefully to avoid the proliferation of bacteria.

Remove the support surface by lifting the sides of the front part by 45° and sliding it out towards the front of the machine.

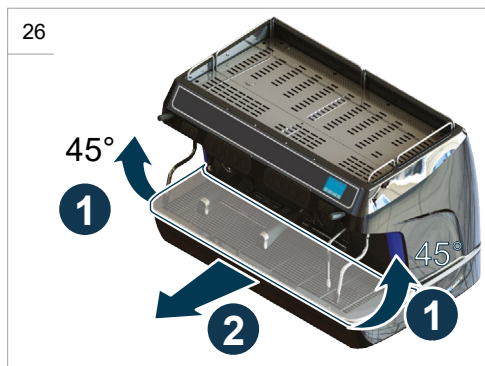

Tools needed for cleaning:

- Non-abrasive sponge;
- Hot water;
- Dishwasher detergent.

Reassemble the support surface in reverse order.

5.3 COFFEEGROUPWASHING

Carry out washing every day at the end of the work shift.



WARNING

Do not wash the parts and the filter holder in the dishwasher.

On the display, from the main menu, press  to access the wash menu.

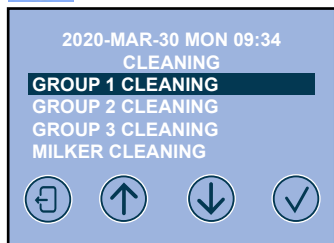

Select the coffee unit to wash 1, 2 or 3 and press .

During the washing cycle of a unit, coffee can be dispensed from the other units.

Insert the blind filter into the filter holder and a detergent pad.



NOTE

For washing operations, use the Carimali detergent pads (06.00133).



Press  to start washing.

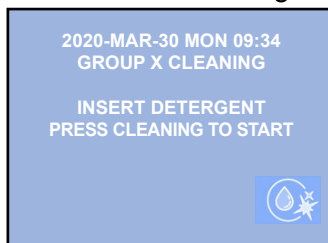

Test dispensing a few times after cleaning.

5.4 WASHING THE MILKER

On the display, from the main menu, press to access the wash menu.

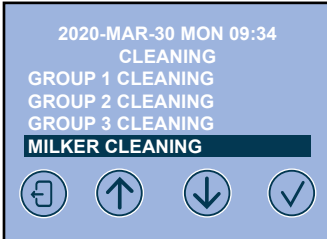

Select the Milker cleaning and press .

Connect the Milker circuit to a container with CARIMALI water and sanitiser (06.00136). Follow the instructions on the sanitiser package for correct dilution.

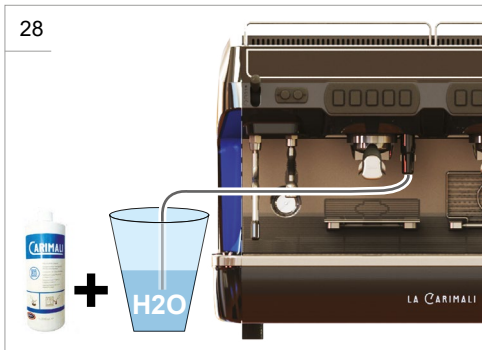

Press to start washing.

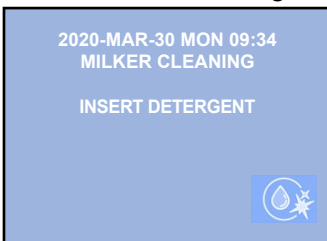

At the end of the first washing phase, connect the Milker circuit to a container with clean water for rinsing.

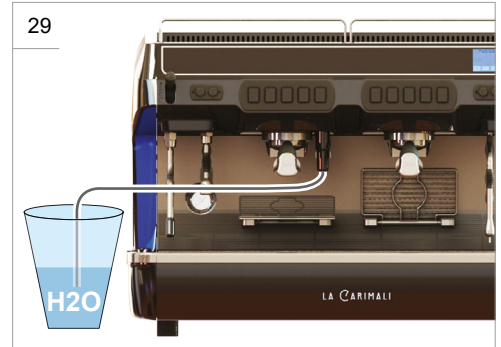

Press to start washing.

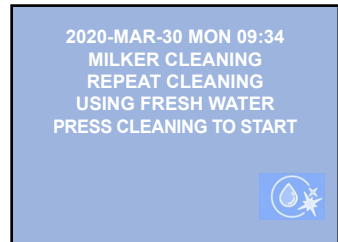

Wait for the Milker rinse to complete.

ATTENTION

If the washing cycle is interrupted before it is finished, the procedure must be repeated from the beginning, making sure that the rinsing phase is performed.

Test dispensing a few times after cleaning.

5.4.1 MANUAL WASHING OF THE MILKER

Free the Milker from its housing.

30



Remove the Milker cover.

31



Disconnect the connection hoses of the milk circuit.

32

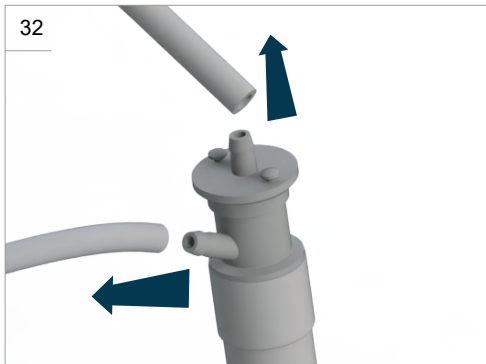

Remove the Milker.

33

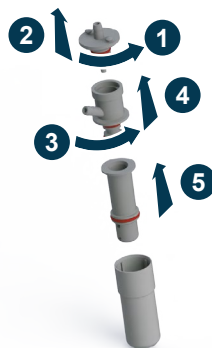

ATTENTION

To prevent the risk of contamination of the dispensed drinks, carry out the cleaning procedure on a regular basis, following the instructions described in this manual.



NOTE

For cleaning operations, use the CARIMALI cleaning agent (06.00136).



Required tools for cleaning:

- Brush (CARIMALI 95.01806);
- Hot water;
- Cleaning agent.

Immerse all components in a solution of hot water and cleaning agent CARIMALI.

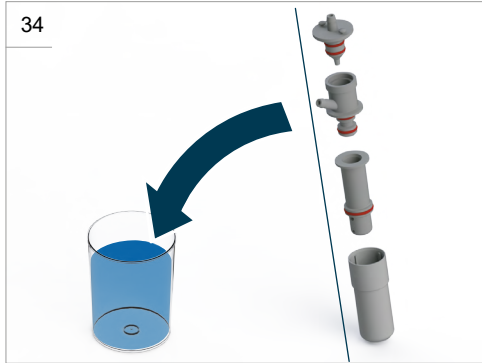

Brush the Milker dispensing nozzle with the brush to remove the residues.

Make sure that the components are completely dry before re-installing them in the machine to avoid the proliferation of bacteria.

Reassemble the Milker in reverse order.

5.5 STEAM WAND WASHING

Wash every day at the end of the work shift.

1. Take a 500ml container with cold water and mix with CARIMALI liquid detergent (06.00136). For doses, see the product label.
2. Insert the steam wand into the container and lower and raise the steam lever (1 second low, 10 seconds high), a total of 10 repetitions.

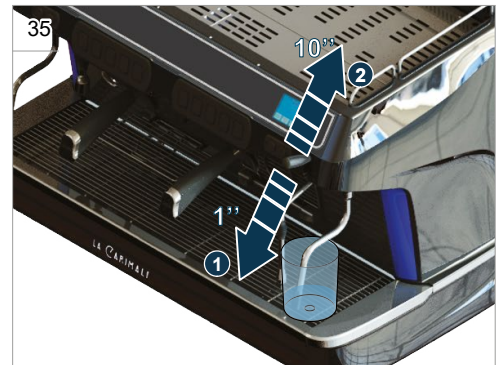

3. Remove the steam wand and discard the liquid.
4. Fill the container again with cold water and repeat step 2.
5. Remove the steam wand and discard the liquid.
6. Complete the procedure by performing the operations in point 2 three times without load.

Make sure you have thoroughly cleaned the part in contact with liquids (from the sealing rubber to the nozzle).

5.6 WASHING THE BARMAN STEAM WAND

Wash every day at the end of the work shift.

Remove the dispensing nozzle and remove the wand body to clean the internal parts.



Clean the parts with the brush supplied and a cloth.



Clean the inside of the Barman wand using a cloth.



Reinsert the wand body and the dispensing nozzle.



5.7 HOT WATER SPOUT WASHING

Dispense a small dose of water and dry the spout with a dry cloth.



If cleaning is not optimal, repeat this operation several times.

5.8 CLEANING OF THE SPRAYHEAD, FILTER HOLDER AND FILTER

To remove other coffee residues, use the brush supplied to wipe the coffee group spray head and the filter holder.



Remove the sprayhead weekly and thoroughly clean the filter and its holder.

Carry out this operation when the machine is cold and with the main switch in the “0” position.

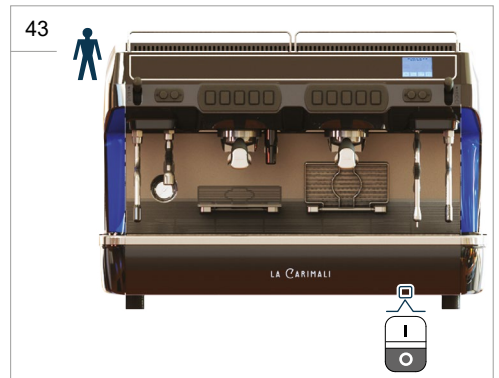

1. Remove the sprayhead by unscrewing the screw **(A)** located in the centre. **The block will automatically fall down.**

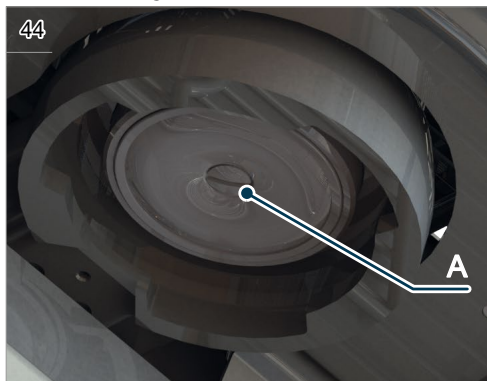

2. Also remove the gasket **(B)** and detach the o-ring **(C)** from the block.

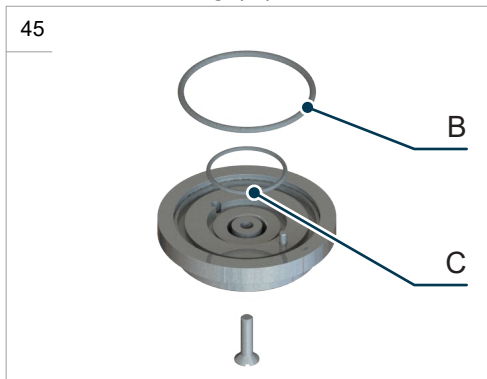

3. Prepare a tall container with about 500ml of very hot water and insert a tablet of Carimali detergent (06.00133).
4. Soak all metal parts for about 10 minutes.
5. When finished, remove the components from the container and rinse them under running hot water, rubbing them with the brush supplied.

Reassemble the sprayhead, the filter and the filter holder, proceeding in reverse order.



NOTE

To replace the gaskets or other consumable components, refer to the Manufacturer's maintenance plan or to the state of wear of the parts themselves.

6 TROUBLESHOOTING

 For faults or situations not described in this manual or when necessary, contact the Service centre.

FAULT	POSSIBLE CAUSE	POSSIBLE SOLUTION
The machine does not turn on (display off).	Incorrect electrical connection.	Check the correct connection of the plug to the socket.
		Check the main switch of the room.
		Check the position of the switch in the machine (see chapter 4.1).
		Contact the Service centre.
Display on but the push-button panels are off.	Faulty electrical connection of the components / push-button panels.	Check if the machine is warming up.
		Contact the Service centre.
Voltage in the machine but the display is off.	Electrical connection / display faulty.	Contact the Service centre.
Display on and readable but the touch controls do not respond.	Film / display faulty.	Contact the Service centre.
Drinks not dispensed correctly.	Push-button doses set.	Contact the Service centre.
	The quality of the extracted drink is not acceptable.	Check the coffee dose.
		Check the grinding.
		Clean the coffee unit (see chapter 5.3) and Milker if there is one (see chapter 5.4).
Contact the Service centre.		

6.1 HOW TO DETECT AN ERROR

46

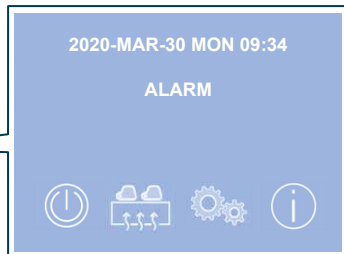

6.2 OPERATING ALARMS

Below are some alarms that may appear on the display.
For all alarms not described in this manual, contact Technical Support.

FILLING UP T.O. (32)



CAUSE	CONSEQUENCE	POSSIBLE SOLUTION
<p>The boiler filling phase has exceeded the maximum time of 9 minutes as first filling, the others take 2 minutes; the probe level (SLC) has not been reached.</p>	<p>The machine is OFF and an alarm message appears on the display.</p>	<p>Check:</p> <ul style="list-style-type: none"> • If the water supply tap is open. • Cleaning of the water inlet filter. • The water pressure. • The softener system, if any. <p>To reset the alarm, turn the machine off and then on again.</p>

SIGNAL OF THE GRX VOLUMETRIC METER

This alarm does not have a numeric code.



CAUSE	CONSEQUENCE	POSSIBLE SOLUTION
<p>The volumetric counter does not send signals to the microprocessor for 3 consecutive seconds.</p>	<p>Dispensing continues until a time out of 240 seconds or until the selected button is pressed. After 120 seconds from the appearance of this alarm, the alarm "GRX INFUSION TIME OUT" will appear.</p>	<p>In the event that the coffee is not dispensed, check:</p> <ul style="list-style-type: none"> • The presence of mains water. • The filtering system / softening system of the incoming water and the various filters. • The cleaning conditions of the unit. <p>If the problem persists, contact Technical Support.</p>



NOTE

If the coffee is dispensed continuously, use the machine as if it were manual: press the key required to start the dose, then press the same key to stop the dispensed dose, after checking the quantity in the cup. If dispensing continues until the aforementioned 120 second time out, dispensing will be interrupted and the display will show the message indicating that a volumetric meter time out problem has occurred. At the next dose, the message will be cancelled if dispensing is successful.

GRX INFUSION TIME OUT (41, 42, 43)

This alarm appears 120 seconds after the alarm “GRX VOLUMETRIC METER SIGNAL” appears.

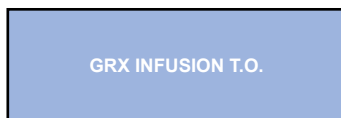

CAUSE	CONSEQUENCE	POSSIBLE SOLUTION
Coffee brewing time is greater than 120 seconds.	The machine turns OFF.	<p>In the event that the coffee is not dispensed, check:</p> <ul style="list-style-type: none"> • The presence of mains water. • The filtering system / softening system of the incoming water and the various filters. • The cleaning conditions of the unit. <p>If the problem persists, contact Technical Support.</p>

STEAM WAND TEMPERATURE (36)

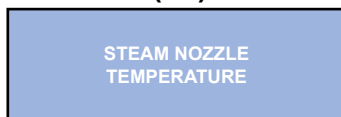

CAUSE	CONSEQUENCE	POSSIBLE SOLUTION
<p>The temperature read by the steam wand sensor is out of range:</p> <ul style="list-style-type: none"> • greater than 141° C. • less than 0° C (unlikely situation; sensor failure). 	The steam wand works without the control of the temperature probe.	Press the button to start the steam and press it again to stop the flow.

MAINTENANCE OF THE CLEANER FILTER (90) (90)

This alarm does not block dispensing. The filter alarm can be excluded by setting the litre value to zero.

CHANGE WATER FILTER

CAUSE	CONSEQUENCE	POSSIBLE SOLUTION
The volumetric meter has reached the maximum value of X litres of water supplied, previously programmed.	None.	To cancel the alarm, see the Info-Reset section. If the problem persists, contact Technical Support.

MAINTENANCE (92)

MAINTENANCE

CAUSE	CONSEQUENCE	POSSIBLE SOLUTION
The machine has reached the number of programmed cycles or the inspection date.	None.	Contact Technical Support.

WASHING OF MILKER 1 - 2

This alarm does not have a numeric code.

MILKER X CLEANING

CAUSE	CONSEQUENCE	POSSIBLE SOLUTION
An operating date earlier than today has been set.	None.	Correct the date in the setup menu.

GRX LOW TEMPERATURE

This alarm does not have a numeric code.

LOW GRX TEMPERATURE

CAUSE	CONSEQUENCE	POSSIBLE SOLUTION
The temperature of the unit read by the sensor is lower than 10° C.	None.	<ul style="list-style-type: none"> • Wait for the unit to return to the set temperature. • Check the supplied water quantity.

ADJUSTMENT FOR COARSER GRINDING

This alarm does not have a numeric code.

ADJUST GRINDER COARSE

CAUSE	CONSEQUENCE	POSSIBLE SOLUTION
With the CHRONO function enabled, the set brewing time is greater than the actual brewing time (including tolerance).	Extraction problem / scarce coffee spilling from the filter holder.	<ul style="list-style-type: none"> • Check / calibrate the coffee grinding. • Clean the sprayhead and filter. • Check the quantity of coffee introduced in the filter.

ADJUSTMENT FOR FINER GRINDING

This alarm does not have a numeric code.

ADJUST GRINDER FINE

CAUSE	CONSEQUENCE	POSSIBLE SOLUTION
With the CHRONO function enabled, the set brewing time is greater than the actual brewing time (without tolerance).	Abundant flow of coffee exiting the filter holder.	<ul style="list-style-type: none"> • Check / calibrate the coffee grinding. • Check the quantity of coffee introduced in the filter.

7 DISPOSAL

This machine is compliant with the Directive 2012/19/EU.

If you decide to take the device out of service, it is recommended to make it inoperative after having disconnected the plug.



The disposal of the machine is not responsibility of the Manufacturer and must be carry out in compliance with the applicable regulations.

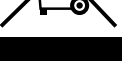

The Customer is held to deliver the material to the designated collection facilities.

Follow the aforesaid disposal procedures, subject to penalties set forth in the applicable waste legislation.



Carimali S.p.A.

Via Industriale, 1
Chignolo d'Isola (BG)
24040 - ITALIA

 +39 035 4949555

 +39 035 905447

 info@carimali.com

 carimali.com

