

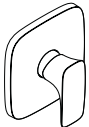















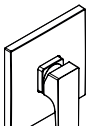

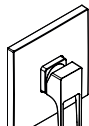

DE	Gebrauchsanleitung / Montageanleitung
FR	Mode d'emploi / Instructions de montage
EN	Instructions for use / Assembly instructions
IT	Istruzioni per l'uso / Istruzioni per Installazione
ES	Modo de empleo / Instrucciones de montaje
NL	Gebruiksaanwijzing / Handleiding
DK	Brugsanvisning / Monteringsvejledning
PT	Instruções para uso / Manual de Instalação
PL	Instrukcja obsługi / Instrukcja montażu
CS	Návod k použití / Montážní návod
SK	Návod na použitie / Montážny návod
ZH	用户手册 / 组装说明
RU	Руководство пользователя / Инструкция по монтажу
FI	Käyttöohje / Asennusohje
SV	Bruksanvisning / Monteringsanvisning
LT	Vartotojo instrukcija / Montavimo instrukcijos
HR	Upute za uporabu / Uputstva za instalaciju
RO	Manual de utilizare / Instrucțiuni de montare
EL	Οδηγίες χρήσης / Οδηγία συναρμολόγησης
SL	Navodilo za uporabo / Navodila za montažo
ET	Kasutusjuhend / Paigaldusjuhend
LV	Lietošanas pamācība / Montāžas instrukcija
SR	Uputstvo za upotrebu / Uputstvo za montažu
NO	Bruksanvisning / Montasjeveiledning
BG	Инструкция за употреба / Ръководство за монтаж
JP	取扱説明書 / 施工説明書
SQ	Udhëzuesi i përdorimit / Udhëzime rreth montimit
AR	دليل الاستخدام / تعليمات التجميع
TR	Kullanım kılavuzu / Montaj kılavuzu
HE	הוראות שימוש / הוראות הרכבה
HU	Használati útmutató / Szerelési útmutató

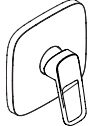
2				
3				
4				
5	PuraVida	Metris	Metris S	Focus
6	15665XXX	31456000	31665000	31965000
7				
8				
9				
10				
11	Metris	Logis	Talis S	Talis E
12	31685000	71605000	72605000	71765XXX
13				
14				
15	Metropol	Logis E	Metropol	Talis S
16	32565XXX	71603000	74565000	32675XXX
17				
18				
19				
20	Talis Classic	Metropol Classic	Logis Loop	Vernis Blend
21	14165000	31365XXX	71267000	71667XXX
22				
23				
24				
25	Vernis Shape	Novus	Novus Loop	Vivenis
26	71668XXX	71065000	71365000	75615XXX
27				
28				
29				
30				
31				
32	Finoris	Rebris S	Rebris E	
	76615XXX	72667XXX	72668XXX	

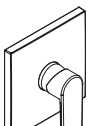

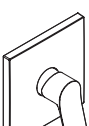
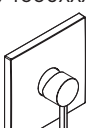
Sicherheitshinweise

- ⚠ Bei der Montage müssen zur Vermeidung von Quetsch- und Schnittverletzungen Handschuhe getragen werden.
- ⚠ Das Produkt darf nur zu Bade-, Hygiene- und Körperreinigungszwecken eingesetzt werden.
- ⚠ Große Druckunterschiede zwischen den Kalt- und Warmwasseranschlüssen müssen ausgeglichen werden.

Montagehinweise

- Vor der Montage muss das Produkt auf Transportschäden untersucht werden. Nach dem Einbau werden keine Transport- oder Oberflächenschäden anerkannt.
- Die Leitungen und die Armatur müssen nach den gültigen Normen montiert, gespült und geprüft werden.
- Die in den Ländern jeweils gültigen Installationsrichtlinien sind einzuhalten.

Technische Daten

Betriebsdruck:	max. 1 MPa
Empfohlener Betriebsdruck:	0,1 - 0,5 MPa
Prüfdruck:	1,6 MPa
	(1 MPa = 10 bar = 147 PSI)
Heißwassertemperatur:	max. 60°C
Thermische Desinfektion:	70°C / 4 min

Das Produkt ist ausschließlich für Trinkwasser konzipiert!

Symbolerklärung

 Kein essigsäurehaltiges Silikon verwenden!

 **Justierung** (siehe Seite 36)

Einstellen der Warmwasserbegrenzung. In Verbindung mit Durchlauferhitzern ist eine Warmwassersperre nicht zu empfehlen.

 **Wartung** (siehe Seite 38)

 **Maße** (siehe Seite 40)

 **Durchflussdiagramm**
(siehe Seite 41)

freier Durchfluss

 **Serviceteile** (siehe Seite 42)

 **Sonderzubehör** (siehe Seite 42)
nicht im Lieferumfang enthalten

- Verlängerung 25 mm #13595000

- Verlängerung 22 mm (bei geringer Einbautiefe) #15597XXX, #13597XXX, #13596000, #13593XXX

 **Reinigung** (siehe Seite 37)

 **Bedienung** (siehe Seite 41)

 **Prüfzeichen** (siehe Seite 48)

Störung	Ursache	Abhilfe
Wenig Wasser	- EcoSmart® verschmutzt / defekt	- EcoSmart® reinigen bzw. austauschen (siehe Seite 38)
Armatur schwergängig	- Kartusche defekt, verkalkt	- Kartusche austauschen
Armatur tropft	- Kartusche defekt	- Kartusche austauschen
Zu niedrige Warmwassertemperatur, kein Kaltwasser. Durchlauferhitzer springt an, wenn Kaltwasser ausgewählt wird.	- Warmwasserbegrenzung falsch eingestellt - Kreuzfluss	- Warmwasserbegrenzung einstellen - Kartusche austauschen



Consignes de sécurité

- ⚠ Lors du montage, porter des gants de protection pour éviter toute blessure par écrasement ou coupure.
- ⚠ Le produit ne doit servir qu'à se laver et à assurer l'hygiène corporelle.
- ⚠ Il est conseillé d'équilibrer les pressions de l'eau chaude et froide.

Instructions pour le montage

- Avant son montage, s'assurer que le produit n'a subi aucun dommage pendant le transport. Après le montage, tout dommage de transport ou de surface ne pourra pas être reconnu.
- Les conduites et la robinetterie doivent être montés, rincés et contrôlés selon les normes en vigueur.
- Les directives d'installation en vigueur dans le pays concerné doivent être respectées.

Informations techniques

Pression de service autorisée: max. 1 MPa
 Pression de service conseillée: 0,1 - 0,5 MPa
 Pression maximum de contrôle: 1,6 MPa
 (1 MPa = 10 bar = 147 PSI)

Température d'eau chaude: max. 60 °C
 Désinfection thermique: 70 °C / 4 min

Le produit est exclusivement conçu pour de l'eau potable!

Description du symbole



Ne pas utiliser de silicone contenant de l'acide acétique!



Étalonnage (voir pages 36)

Réglage de la limitation d'eau chaude. En liaison avec les chauffe-eau, un blocage de l'eau chaude n'est pas recommandable.



Entretien (voir pages 38)



Dimensions (voir pages 40)



Diagramme du débit (voir pages 41)

débit libre



Pièces détachées (voir pages 42)



Accessoires en option (voir pages 42)

ne fait pas partie de la fourniture

- jeu de rallonge 25 mm #13595000
- Rallonge de 22 mm (pour profondeur de montage trop faible)#15597XXX, #13597XXX, #13596000, #13593XXX



Nettoyage (voir pages 37)



Instructions de service (voir pages 41)



Classification acoustique et débit (voir pages 48)

Dysfonctionnement

Origine

Solution

Pas assez d'eau	- EcoSmart® encrassé ou défectueux	- Nettoyez / changez le EcoSmart® (voir pages 38)
Dureté de fonctionnement	- Cartouche défectueuse, entartrée	- Changer la cartouche
Le mitigeur goutte	- Cartouche défectueuse	- Changer la cartouche
Température d'eau chaude trop basse, pas d'eau froide Le chauffe eau instantané met en route quand on puise de l'eau froide.	- Limiteur de température mal positionné	- Positionner le limiteur de température
	- Flux inversé	- Changer la cartouche



Safety Notes

- ⚠ Gloves should be worn during installation to prevent crushing and cutting injuries.
- ⚠ The product may only be used for bathing, hygienic and body cleaning purposes.
- ⚠ The hot and cold supplies must be of equal pressures.

Installation Instructions

- Prior to installation, inspect the product for transport damages. After it has been installed, no transport or surface damage will be honoured.
- The pipes and the fixture must be installed, flushed and tested as per the applicable standards.
- The plumbing codes applicable in the respective countries must be observed.

Technical Data

Operating pressure: max. 1 MPa
 Recommended operating pressure: 0,1 - 0,5 MPa
 Test pressure: 1,6 MPa
 (1 MPa = 10 bar = 147 PSI)

Hot water temperature: max. 60 °C
 Thermal disinfection: 70 °C / 4 min

The product is exclusively designed for drinking water!

Symbol description



Do not use silicone containing acetic acid!



Adjustment (see page 36)

To adjust the hot water limiter. Using a hot water limiter in combination with a continuous flow water heater is not recommended.



Maintenance (see page 38)



Dimensions (see page 40)



Flow diagram (see page 41)

free flow



Spare parts (see page 42)



Special accessories (see page 42)

order as an extra

- extension 25 mm #13595000
- Extension Set 22 mm (when wall is not deep enough)#15597XXX, #13597XXX, #13596000, #13593XXX



Cleaning (see page 37)



Operation (see page 41)



Test certificate (see page 48)

Fault	Cause	Remedy
Insufficient water	- EcoSmart® dirty or leaking	- Clean or exchange EcoSmart® (see page 38)
Mixer stiff	- Cartridge defective, calcified	- Exchange cartridge
Mixer dripping	- Cartridge defective	- Exchange cartridge
Hot water temperature too low, no cold water. Instantaneous water heater starts up when cold water is selected.	- Hot water limiter incorrectly set - Crossflow	- Set hot water limiter - Exchange cartridge



Indicazioni sulla sicurezza

- ⚠ Durante il montaggio, per evitare ferite da schiacciamento e da taglio bisogna indossare guanti protettivi.
- ⚠ Il prodotto deve essere utilizzato esclusivamente per fare il bagno e per l'igiene del corpo.
- ⚠ Attenzione! Compensare le differenze di pressione tra i collegamenti dell'acqua fredda e dell'acqua calda.

Istruzioni per il montaggio

- Prima del montaggio è necessario controllare che non ci siano stati danni durante il trasporto. Una volta eseguito il montaggio, non verranno riconosciuti eventuali danni di trasporto o delle superfici.
- Montare, lavare e controllare tubature e rubinetteria rispettando le norme correnti.
- Vanno rispettate le direttive di installazione nazionali vigenti nel rispettivo paese.

Dati tecnici

Pressione d'uso:	max. 1 MPa
Pressione d'uso consigliata:	0,1 - 0,5 MPa
Pressione di prova:	1,6 MPa
	(1 MPa = 10 bar = 147 PSI)
Temperatura dell'acqua calda:	max. 60 °C
Disinfezione termica:	70 °C / 4 min

Il prodotto è concepito esclusivamente per acqua potabile!

Descrizione simbolo



Non utilizzare silicone contenente acido acetico!



Taratura (vedi pagg. 36)

Regolazione del limitatore di erogazione d'acqua calda. Un limitatore di erogazione di acqua calda in combinazione con le caldaie istantanee non è consigliabile.



Manutenzione (vedi pagg. 38)



Ingombri (vedi pagg. 40)



Diagramma flusso (vedi pagg. 41)
portata libero



Parti di ricambio (vedi pagg. 42)



Accessori speciali (vedi pagg. 42)
non contenuto nel volume di fornitura

- Prolunga 25 mm #13595000
- Prolunga 22 mm x set esterno (in caso di incasso troppo esterno al muro) #15597XXX, #13597XXX, #13596000, #13593XXX



Pulitura (vedi pagg. 37)



Procedura (vedi pagg. 41)



Segno di verifica (vedi pagg. 48)

Problema	Possibile causa	Rimedio
Scarsità d'acqua	- EcoSmart® sporco o non ermetico	- Pulire / sostituire del EcoSmart® (vedi pagg. 38)
Miscelatore duro	- Cartuccia difettosa	- Sostituire la cartuccia
Miscelatore gocciola	- Cartuccia difettosa	- Sostituire la cartuccia
Temperatura dell'acqua calda troppo bassa, niente acqua fredda, caldaia istantanea si accende quando si seleziona acqua fredda	- Limitazione dell'acqua calda regolata male - Flusso incrociato	- Regolare la limitazione dell'acqua calda - Sostituire la cartuccia



Indicaciones de seguridad

- ⚠ Durante el montaje deben utilizarse guantes para evitar heridas por aplastamiento o corte.
- ⚠ El producto solo debe ser utilizado para fines de baño, higiene y limpieza corporal.
- ⚠ Grandes diferencias de presión en servicio entre agua fría y agua caliente deben equilibrarse.

Indicaciones para el montaje

- Antes del montaje se debe examinar el producto contra daños de transporte. Después de la instalación no se reconoce ningún daño de transporte o de superficie.
- Los conductos y la grifería deben montarse, lavarse y comprobarse según las normas vigentes.
- Es obligatorio el cumplimiento de las directrices de instalación vigentes en el país respectivo.

Datos técnicos

Presión en servicio:	max. 1 MPa
Presión recomendada en servicio:	0,1 - 0,5 MPa
Presión de prueba:	1,6 MPa (1 MPa = 10 bar = 147 PSI)
Temperatura del agua caliente:	max. 60 °C
Desinfección térmica:	70 °C / 4 min

El producto ha sido concebido exclusivamente para agua potable.

Descripción de símbolos



No utilizar silicona que contiene ácido acético!



Ajuste (ver página 36)

Ajuste del límite de agua caliente. En combinación con calentadores continuos no es recomendable utilizar un bloqueo de agua caliente.



Mantenimiento (ver página 38)



Dimensiones (ver página 40)



Diagrama de circulación

(ver página 41)

caudal libre



Repuestos (ver página 42)



Opcional (ver página 42)

no incluido en el suministro

- Prolongación 25 mm #13595000
- Alargo 22 mm (en caso de pared delgada) #15597XXX, #13597XXX, #13596000, #13593XXX



Limpiar (ver página 37)



Manejo (ver página 41)



Marca de verificación

(ver página 48)

Problema	Causa	Solución
Sale poca agua	- EcoSmart® sucia o pierde	- limpiar / cambiar EcoSmart® (ver página 38)
Manecilla va dura	- cartucho dañado	- cambiar el cartucho
Grifo pierde agua	- cartucho dañado	- cambiar el cartucho
Temperatura del agua caliente demasiado baja, agua fría calentador se dispara al abrir agua fría	- tope de agua caliente mal - Flujo cruzado	- ajustar tope - cambiar el cartucho



Veiligheidsinstructies

- ⚠ Bij de montage moeten ter voorkoming van knel- en snijwonden handschoenen worden gedragen.
- ⚠ Het product mag alleen voor het wassen, hygiënische doeleinden en voor de lichaamsreiniging worden gebruikt.
- ⚠ Grote drukverschillen tussen de koud- en warmwater-toevoer dienen vermeden te worden.

Montage-instructies

- Vóór de montage moet het product gecontroleerd worden op transportschade. Na de inbouw wordt geen transport- of oppervlakteschade meer aanvaard.
- De leidingen en armaturen moeten gemonteerd, gespoeld en gecontroleerd worden volgens de geldige normen.
- De in de overeenkomstige landen geldende installatierichtlijnen moeten nageleefd worden.

Technische gegevens

Werkdruk: max. 1 MPa
 Aanbevolen werkdruk: 0,1 - 0,5 MPa
 Getest bij: 1,6 MPa
 (1 MPa = 10 bar = 147 PSI)

Temperatuur warm water: max. 60 °C
 Thermische desinfectie: 70 °C / 4 min

Het product is uitsluitend ontworpen voor drinkwater!

Symboolbeschrijving

Gebruik geen zuurhoudende silicone!

Instellen (zie blz. 36)

Instellen van de warmwaterbegrenzing. In combinatie met een doorstromer is een warmwaterblokkering niet aanbevelenswaardig.

Onderhoud (zie blz. 38)

Maten (zie blz. 40)

Doorstroombiagram (zie blz. 41)
vrije doorstroom

Service onderdelen (zie blz. 42)

Toebehoren (zie blz. 42)

behoort niet tot het leveringspakket

- Verlengstuk 25 mm #13595000

- verlengset 22 mm (bij geringe inbouwdiepte) #15597XXX, #13597XXX, #13596000, #13593XXX

Reinigen (zie blz. 37)

Bediening (zie blz. 41)

Keurmerk (zie blz. 48)

Storing	Oorzaak	Oplossing
Weinig water	- EcoSmart® vervuild of defect	- EcoSmart® reinigen / uitwisselen (zie blz. 38)
Bediening zwaar	- Kardoes defect of verkalkt	- Kardoes uitwisselen
Mengkraan lekt	- Kardoes defect	- Kardoes uitwisselen
Warmwater temperatuur te laag, geen koud water. Doorstroomtoestel springt aan wanneer koud water gekozen is.	- Heetwaterbegrenzer verkeerd ingesteld - Kruisstroom	- Heetwaterbegrenzer instellen - Kardoes uitwisselen



Sikkerhedsanvisninger

- ⚠ Ved monteringen skal der bruges handsker for at undgå kvæstelser og snitsår.
- ⚠ Produktet må kun bruges til bade-, hygiejne og kroppsrenøringssformål.
- ⚠ Større trykforskelle mellem koldt og varmt vand bør udjævnes.

Monteringsanvisninger

- Før monteringen skal produktet kontrolleres for transportskader. Efter monteringen godkendes transportskader eller skader på overfladen ikke længere.
- Ledningerne og armaturerne skal monteres, skylles og kontrolleres iht. de gældende standarder.
- Installationsbestemmelserne, der gælder i det enkelte land, skal overholdes.

Tekniske data

Driftstryk:	max. 1 MPa
Anbefalet driftstryk:	0,1 - 0,5 MPa
Prøvetryk:	1,6 MPa (1 MPa = 10 bar = 147 PSI)
Varmtvandstemperatur:	max. 60 °C
Termisk desinfektion:	70 °C / 4 min
Produktet er udelukkende beregnet til drikkevand!	

Symbolbeskrivelse



Der må ikke benyttes eddikesyreholdig silikone!



Forindstilling (se s. 36)

Indstilling af varmvandsbegrænsningen. I forbindelse med gennemstrømningsvandvarmere anbefaler vi ikke en varmvandsspærre.



Service (se s. 38)



Målene (se s. 40)



Gennemstrømningsdiagram

(se s. 41)

fri gennemstrømning



Reserve dele (se s. 42)



Specialtilbehør (se s. 42)

ikke med i leveringsomfang

- Forlængersæt 25 mm #13595000
- Forlænger 22 mm (ved for stor indbygningsdybde) #15597XXX, #13597XXX, #13596000, #13593XXX



Rengøring (se s. 37)



Brugsanvisning (se s. 41)



Godkendelse (se s. 48)

Fejl	Årsag	Hjælp
For lidt vand	- EcoSmart® er snavset eller utæt.	- Rengør / udskift EcoSmart® (se s. 38)
Grebet går trægt	- Kartusche defekt, tilkalket	- Udskift kartusche
Armaturet drypper	- Defekt kartusche	- Udskift kartusche
For lav varmtvandstemperatur. Ingen koldt vand. Vandvarmeren starter, når der åbnes for det kolde vand.	- Varmtvandsbegrænsningen er forkert indstillet - Kryds-flow	- Indstil varmtvandsbegrænsningen - Udskift kartusche



Avisos de segurança

- ⚠ Durante a montagem devem ser utilizadas luvas de protecção, de modo a evitar ferimentos resultantes de entalamentos e de cortes.
- ⚠ O produto só pode ser utilizado para fins de higiene pessoal.
- ⚠ Grandes diferenças entre as pressões das águas quente e fria devem ser compensadas.

Avisos de montagem

- Antes da montagem deve-se controlar o produto relativamente a danos de transporte. Após a montagem não são aceites quaisquer danos de transporte ou de superfície.
- As tubagens e a torneira têm que ser montadas, enxaguadas e verificadas de acordo com as normas em vigor.
- A prescrições de instalação válidas nos respetivos países devem ser respeitadas.

Dados Técnicos

Pressão de funcionamento:	max. 1 MPa
Pressão de func. recomendada:	0,1 - 0,5 MPa
Pressão testada:	1,6 MPa (1 MPa = 10 bar = 147 PSI)
Temperatura da água quente:	max. 60 °C
Desinfecção térmica:	70 °C / 4 min

Este produto foi única e exclusivamente concebido para água potável!

Descrição do símbolo



Não utilizar silicone que contenha ácido acético!



Afinação (ver página 36)

Ajuste do limitador de água quente. Em combinação com um esquentador, não é recomendável o uso de um bloqueio de água quente.



Manutenção (ver página 38)



Medidas (ver página 40)



Fluxograma (ver página 41)
caudal livre



Peças de substituição
(ver página 42)



Acessórios especiais
(ver página 42)

não incluído no volume de fornecimento

- Crescente 25 mm #13595000
- Crescente 22 mm (quando instalado demasiado longe da parede)#15597XXX, #13597XXX, #13596000, #13593XXX



Limpeza (ver página 37)



Funcionamento (ver página 41)



Marca de controlo (ver página 48)

Falha	Causa	Solução
Água insuficiente	- EcoSmart® sujo ou com fugas	- Limpar / trocar o EcoSmart® (ver página 38)
Misturadora perra	- Cartucho defeituoso, calcificado	- Substituir o cartucho
Misturadora a pingar	- Cartucho defeituoso	- Substituir o cartucho
Temperatura da água quente muito baixa, sem água fria. O esquentador dispara quando a água fria está seleccionada.	- O limitador de temperatura está incorrectamente colocado - Fluxo cruzado	- Regular o limitador de temperatura - Substituir o cartucho



Wskazówki bezpieczeństwa

- ⚠ Aby uniknąć zranień na skutek zgniecenia lub przecięcia, podczas montażu należy nosić rękawice ochronne.
- ⚠ Produkt może być używany tylko do kąpieli, higieny i czyszczenia ciała.
- ⚠ Znaczne różnice ciśnień na dopływach ciepłej i zimnej wody muszą zostać wyrównane.

Wskazówki montażowe

- Przed montażem należy skontrolować produkt pod kątem szkód transportowych. Po montażu nie widać żadnych szkód transportowych ani szkód na powierzchni.
- Przewody i armatura muszą być montowane, płukane i kontrolowane według obowiązujących norm.
- Należy przestrzegać wytycznych instalacyjnych obowiązujących w danym kraju.

Dane techniczne

Ciśnienie robocze:	maks. 1 MPa
Zalecane ciśnienie robocze:	0,1 - 0,5 MPa
Ciśnienie próbné:	1,6 MPa (1 MPa = 10 bary = 147 PSI)
Temperatura wody gorącej:	maks. 60 °C
Dezynfekcja termiczna:	70 °C / 4 min
Produkt przeznaczony wyłącznie do wody pitnej!	

Opis symbolu



Nie stosować silikonów zawierających kwas octowy!



Ustawianie (patrz strona 36)

Ustawianie ogranicznika ciepłej wody. Używanie ogranicznika temperatury wody w połączeniu z przepływowym podgrzewaczem wody nie jest zalecane.



Konserwacja (patrz strona 38)



Wymiary (patrz strona 40)



Schemat przepływu

(patrz strona 41)

swobodny przepływ



Części serwisowe (patrz strona 42)



Wyposażenie specjalne

(patrz strona 42)

Nie jest częścią dostawy

- Przedłużka 25 mm #13595000
- Rozeta maskująca 22 mm (przy małej głębokości zabudowy)#15597XXX, #13597XXX, #13596000, #13593XXX



Czyszczenie (patrz strona 37)



Obsługa (patrz strona 41)



Znak jakości (patrz strona 48)

Usterka	Przyczyna	Pomoc
Mała ilość wody	- Zabrudzony / uszkodzony EcoSmart®	- Oczyszczyć wzgl. wymienić EcoSmart® (patrz strona 38)
Uchwyt armatury pracuje z wysiłkiem	- Uszkodzony wkład, zakamieniony	- Wymiana wkładu
Armatura cieknie	- Uszkodzony wkład	- Wymiana wkładu
Za niska temperatura ciepłej wody, brak zimnej wody. Przepływowy podgrzewacz wody uruchamia się, gdy wybiera się zimną wodę.	- Niewłaściwe ustawienie ogranicznik ciepłej wody - Przepływ krzyżowy	- Ustawić ogranicznik ciepłej wody - Wymiana wkładu



Bezpečnostní pokyny

- ⚠ Pro zabránění řezným zraněním a pohmožděninám je nutné při montáži nosit rukavice.
- ⚠ Produkt smí být používán pouze ke koupání a za účelem tělesné hygieny.
- ⚠ Je nutné vyrovnat velké rozdíly tlaku mezi připojí studené a teplé vody.

Pokyny k montáži

- Před montáží je třeba produkt zkontrolovat, zda nebyl při transportu poškozen. Po zabudování nebudou uznány žádné škody způsobené transportem nebo poškození povrchu.
- Vedení a armatura musí být namontovány, propláchnuty a otestovány podle platných norem.
- Je třeba dodržovat montážní pravidla platné v dané zemi.

Technické údaje

Provozní tlak:	max. 1 MPa
Doporučený provozní tlak:	0,1 - 0,5 MPa
Zkušební tlak:	1,6 MPa (1 MPa = 10 bar = 147 PSI)
Teplota horké vody:	max. 60 °C
Tepelná desinfekce:	70 °C / 4 min

Výrobky Hansgrohe jsou vhodné pro přímý kontakt s pitnou vodou.

Popis symbolů



Nepoužívat silikon s obsahem kyseliny octové!



Nastavení (viz strana 36)

Nastavení omezovače teplé vody. Ve spojení s průtokovým ohřivačem se použití uzávěru teplé vody nedoporučuje.



Údržba (viz strana 38)



Rozměry (viz strana 40)



Diagram průtoku (viz strana 41)

volný průtok



Servisní díly (viz strana 42)



Zvláštní příslušenství (viz strana 42)

není součástí dodávky

- prodloužení 25 mm #13595000
- prodloužení 22 mm (při malé hloubce zabudování) #15597XXX, #13597XXX, #13596000, #13593XXX



Čištění (viz strana 37)



Ovládání (viz strana 41)



Zkušební značka (viz strana 48)

Porucha	Příčina	Odstranění
Málo vody	- Znečištěný nebo netěsný EcoSmart®	- vyčistit resp. vyměnit EcoSmart® (viz strana 38)
Armatura jde ztěžka	- Kartuše je vadná, zanesená vodním kamenem	- Kartuši vyměnit
Armatura odkapává	- Kartuše je vadná	- Kartuši vyměnit
nízká teplota teplé vody .žádná studená voda průtokový ohřivač naskočí, když se navolí studená voda	- Špatně nastavená zarážka pro teplou vodu - Křížení toků	- Seřídít zarážku pro teplou vodu - Kartuši vyměnit



Bezpečnostné pokyny

- ⚠ Pri montáži musíte nosiť rukavice, aby ste predišli pomliaždeninám a rezným poraneniam.
- ⚠ Produkt sa smie používať len na kúpanie a telesnú hygienu.
- ⚠ Veľké rozdiely v tlaku medzi prípojkami studenej a teplej vody musia byť vyrovnané.

Pokyny pre montáž

- Pred montážou musíte produkt skontrolovať, či nebol počas transportu poškodený. Po zabudovaní nebudú uznané žiadne škody spôsobené transportom alebo poškodenia povrchu.
- Potrubia a vybavenie musia byť namontované, prepláchnuté a vybavené v platnom normami.
- Je potrebné dodržiavať smernice o inštalácii, ktoré sú práve teraz platné v krajinách.

Technické údaje

Prevádzkový tlak: max. 1 MPa
 Doporučený prevádzkový tlak: 0,1 - 0,5 MPa
 Skúšobný tlak: 1,6 MPa

(1 MPa = 10 bar = 147 PSI)

Teplota teplej vody: max. 60 °C
 Termická dezinfekcia: 70 °C / 4 min

Výrobok je koncipovaný výhradne pre pitnú vodu!

Popis symbolov



Nepoužívať silikón s obsahom kyseliny octovej!



Nastavenie (viď strana 36)

Nastavenie obmedzenia teplej vody. V spojení s prietokovými ohrievačmi sa neodporúča použitie obmedzovača teplej vody.



Údržba (viď strana 38)



Rozmery (viď strana 40)



Diagram prietoku (viď strana 41)

volný prietok



Servisné diely (viď strana 42)



Zvláštne príslušenstvo

(viď strana 42)

nie je súčasťou dodávky

- Predĺženie 25 mm #13595000

- Predĺženie 22 mm (pri malej montážnej hĺbke) #15597XXX, #13597XXX, #13596000, #13593XXX



Čistenie (viď strana 37)



Obsluha (viď strana 41)



Osvedčenie o skúške (viď strana 48)

Porucha	Príčina	Pomoc
Málo vody	- Znečistený alebo netesný EcoSmart®	- Vyčistiť resp. vymeniť EcoSmart® (viď strana 38)
Armatúra "chodí" ťažko	- Kartuša je poškodená, vápenaté usadeniny	- Vymeniť kartušu
Z armatúry kvapká voda	- Kartuša je poškodená	- Vymeniť kartušu
Málo teplá voda, žiadna studená voda, prietokový ohrievač naskočí, keď sa navolí studená voda.	- Nesprávne nastavená zarážka na teplú vodu - Kríženie tokov	- Nastavenie zarážky na teplú vodu - Vymeniť kartušu

**安全技巧**

- △ 装配时为避免挤压和切割受伤, 必须戴上手套.
- △ 本产品只允许作为洗浴, 卫生和洁身之用.
- △ 冷热水管间过大的压力差必须予以平衡.

安装提示

- 安装前必须检查产品是否受到运输损害. 安装后将不认可运输损害或表面损伤.
- 管道和阀门必须根据通用标准进行安装, 冲洗和检查.
- 请遵守当地国家现行的安装规定.

技术参数

工作压力:	最大 1 MPa
推荐工作压力:	0,1 - 0,5 MPa
测试压强:	1,6 MPa (1 MPa = 10 bar = 147 PSI)
热水温度:	最大 60°C
热力消毒:	70°C / 4 分钟

该产品专为饮用水设计!

符号说明

 请勿使用含有乙酸的硅胶!

 **调节** (参见第页 36)

热水温度调节. 如果使用即热式喷头, 则不建议安装热水阀门.

 **保养** (参见第页 38)

 **大小** (参见第页 40)

 **流量示意图** (参见第页 41)
时的流速

 **备用零件** (参见第页 42)

 **选装附件** (参见第页 42)
不在供货范围内

- 加长 25 mm #13595000

- 加长件22mm (墙壁不够深时)#15597XXX,
#13597XXX, #13596000, #13593XXX

 **清洗** (参见第页 37)

 **操作** (参见第页 41)

 **检验标记** (参见第页 48)

问题	原因	补救
龙头出水量小	- EcoSmart® 脏污或泄漏	- 清洁或更换EcoSmart® (参见第页 38)
龙头不灵活	- 阀芯损坏, 结垢	- 更换阀芯
龙头滴水	- 阀芯损坏	- 更换阀芯
热水温度过低, 没有冷水. 选择冷水时, 热水器启动.	- 温度限制器设置错误 - 交叉流动	- 设置温度限制器 - 更换阀芯



Указания по технике безопасности

- ⚠ Во время монтажа следует надеть перчатки во избежание прищемления и порезов.
- ⚠ Изделие разрешается использовать только в гигиенических целях: для принятия ванны и личной гигиены.
- ⚠ донного клапа. Перед установкой смесителя необходимо регулировочными кранами выровнять авление холодной и горячей воды при помощи вентилей регулирующих подачу воды в квартиру.

Указания по монтажу

- Перед монтажом следует проверить изделие на предмет повреждений при перевозке. После монтажа претензии о возмещении ущерба за повреждения при перевозке или повреждения поверхностей не принимаются.
- Трубы и арматура должны быть установлены, промыты и проверены в соответствии с действующими нормами.
- Необходимо соблюдать требования по монтажу, действующие в соответствующих странах.

Технические данные

Рабочее давление: не более. 1 МПа
 Рекомендуемое рабочее давление: 0,1 - 0,5 МПа
 Давления: 1,6 МПа
 (1 МПа = 10 bar = 147 PSI)
 Температура горячей воды: не более. 60 °C
 Термическая дезинфекция: 70 °C / 4 мин
 Изделие предназначено исключительно для питьевой воды!

Описание символов



Не применяйте силикон, содержащий уксусную кислоту.



Подгонка (см. стр. 36)

Регулировка ограничителя горячей воды. В сочетании с проточными нагревателями не рекомендуется использовать блокировку воды.



Техническое обслуживание (см. стр. 38)



Размеры (см. стр. 40)



Схема потока (см. стр. 41)

свободное истечение



Комплект (см. стр. 42)



Специальные принадлежности (см. стр. 42)

- не включено в объем поставки!
- Удлинение 25 мм #13595000
- Удлинение 22 мм (при малой глубине установки) #15597XXX, #13597XXX, #13596000, #13593XXX



Очистка (см. стр. 37)



Эксплуатация (см. стр. 41)



Знак технического контроля (см. стр. 48)

Неисправность	Причина	Устранение неисправности
недостаточный давление (если устан напор воды)	- EcoSmart® загрязнен / неисправен	- Очистите или замените EcoSmart® (см. стр. 38)
Арматура работает с усилием	- Картридж неисправен, засорение накипью	- Замените картридж
Арматура протекает	- Картридж неисправен	- Замените картридж
Слишком низкая температура горячей воды. Проточный нагреватель запускается при выборе холодной воды.	- Ограничение горячей воды отрегулировано неправильно - Перекрестный поток	- Отрегулируйте ограничение горячей воды - Замените картридж

**Turvallisuusohjeet**

- △ Asennuksessa on käytettävä käsineitä puristumien ja viiltojen aiheuttamien tapaturmien estämiseksi.
- △ Tuotetta saa käyttää ainoastaan kylpy-, hygienia- ja puhdistustarkoituksiin.
- △ Suuret paine-erot kylmä- ja kuumavesiliitäntöjen välillä on tasattava.

Asennusohjeet

- Ennen asennusta on tarkastettava tuotteen mahdolliset kuljetusvahingot. Asennuksen jälkeen kuljetus- ja pintavaurioita ei hyväksytä.
- Putket ja hana on asennettava, huuhdeltava ja tarkastettava voimassa olevien standardien mukaisesti.
- Jokaisessa maassa on noudatettava siellä päteviä asennusohjeita.

Tekniset tiedot

Käyttöpaine:	maks. 1 MPa
Suosittelut käyttöpaine:	0,1 - 0,5 MPa
Koestuspaine:	1,6 MPa (1 MPa = 10 bar = 147 PSI)
Kuuman veden lämpötila:	maks. 60 °C
Lämpödesinfektio:	70 °C / 4 min

Tuote on suunniteltu käytettäväksi ainoastaan juomaveden kanssa!

Merkin kuvaus

Älä käytä etikkahappopitoista silikonia!



Säätö (katso sivu 36)

Lämpötilan rajoittimen säätäminen. Emme suosittele käyttämään lämpötilan rajoitinta vedenlämmittimen (läpivirtauskuumennin) yhteydessä.



Huolto (katso sivu 38)



Mitat (katso sivu 40)



Virtausdiagrammi (katso sivu 41)
vapaa läpivirtaus



Varaosat (katso sivu 42)



Erityisvaruste (katso sivu 42)

ei kuulu toimitukseen

- Pidennys 25 mm #13595000
- Pidennys 22 mm (pienemmällä asennussyvyydellä)#15597XXX, #13597XXX, #13596000, #13593XXX



Puhdistus (katso sivu 37)



Käyttö (katso sivu 41)



Koestusmerkki (katso sivu 48)

Häiriö**Syy****Toimenpide**

Vähän vettä	- EcoSmart® likaantunut / viallinen	- Puhdista tai vaihda EcoSmart® (katso sivu 38)
Hana on raskaskäyttöinen	- Patruuna rikki, kalkkikerrostumia	- Vaihda patruuna
Hanasta tippuu vettä	- Patruuna rikki	- Vaihda patruuna
Lämminveden lämpötila liian alhainen, ei kylmää vettä. Läpivirtauskuumennin käynnistyy kylmää vettä otettaessa.	- Lämminveden rajoitin väärin säädetty - Ristiinvirtaus	- Säädä lämminveden rajoitin - Vaihda patruuna



Säkerhetsanvisningar

- △ Handskar ska bäras under monteringsarbetet så att man kan undvika kläm- och skärskador.
- △ Produkten får bara användas till kroppshygien med bad och dusch.
- △ Stora tryckskillnader mellan anslutningarna för varmt och kallt vatten måste utjämnas.

Monteringsanvisningar

- Det måste undersökas om produkten har transportskador innan den monteras. Efter monteringen accepteras inga transport- eller ytskiktsskador.
- Ledningarna och blandaren måste monteras, spolas igenom och kontrolleras enligt de gällande normerna.
- De installationsriktlinjer som gäller i länderna ska följas.

Tekniska data

Drifttryck:	max. 1 MPa
Rek. drifttryck:	0,1 - 0,5 MPa
Tryck vid provtryckning:	1,6 MPa (1 MPa = 10 bar = 147 PSI)
Varmvattentemperatur:	max. 60 °C
Termisk desinfektion:	70 °C / 4 min

Produkten är enbart avsedd för dricksvatten!

Symbolförklaring



Använd inte silikon som innehåller ättiksyra!



Justering (se sidan 36)

Ställa in varmvattenregleringen. Tillsammans med varmvattenberedare rekommenderas inte en varmvatten-spärr.



Skötsel (se sidan 38)



Mått (se sidan 40)



Flödesschema (se sidan 41)

fri genomströmning



Reservdelar (se sidan 42)



Specialtillbehör (se sidan 42)

medföljer ej leveransen

- Förlängning 25 mm #13595000

- Förlängning 22 mm (vid litet monteringsdjup)#15597XXX, #13597XXX, #13596000, #13593XXX



Rengöring (se sidan 37)



Hantering (se sidan 41)



Testsigill (se sidan 48)

Störning	Orsak	Åtgärd
För lite vatten	- EcoSmart® nedsmutsad/defekt	- Rengör eller byt ut EcoSmart® (se sidan 38)
Blandare är trög	- Patron defekt, förkalkad	- Byt ut patron
Blandare droppar	- Patron defekt	- Byt ut patron
För låg varmvattentemperatur, inget kallvatten. Varmvattenberedaren slår på när kallvatten väljs.	- Varmvattenreglering felaktigt inställd - Korsflöde	- Ställ in varmvattenreglering - Byt ut patron

**Saugumo technikos nurodymai**

- ⚠ Apsaugai nuo užspaudimo ir įsijpavimo montavimo metu mūvėkite pirštines.
- ⚠ Gaminys turi būti naudojamas tik maudymuisi, kūno higienai ir švarai palaikyti.
- ⚠ Turi būti išlyginti šalto ir karšto slėgio nelygumai.

Montavimo instrukcija

- Prieš montuojant būtina patikrinti, ar gaminys nebuvo pažeistas transportavimo metu. Sumontavus pretenzijos dėl transportavimo ir paviršiaus pažeidimų nepriimamos.
- Vamzdžiai ir sujungimai turi būti montuojami, plaunami ir tikrinami pagal galiojančias normas.
- Laikykitės atitinkamoje šalyje galiojančių direktyvų dėl įrengimo.

Techniniai duomenys

Darbinis slėgis: ne daugiau kaip 1 MPa
 Rekomenduojamas slėgis: 0,1 - 0,5 MPa
 Bandomasis slėgis: 1,6 MPa
 (1 MPa = 10 barų = 147 PSI)

Karšto vandens temperatūra: ne daugiau kaip 60 °C
 Terminis dezinfekavimas: 70 °C / 4 min

Produktas skirtas tik geriamajam vandeniui!

Simbolio aprašymas

Nenaudokite silikono, kurio sudėtyje yra acto rūgšties!

**Reguliavimas** (žr. psl. 36)

Karšto vandens ribojimas. Kartu su cirkuliaciniais šildytuvais nerekomenduojama naudoti karšto vandens blokavimo įtaisų.

**Techninis aptarnavimas** (žr. psl. 38)**Išmatavimai** (žr. psl. 40)**Pralaidumo diagrama** (žr. psl. 41)

laisvas vandens pralaidumas

**Atsarginės dalys** (žr. psl. 42)**Specialūs priedai** (žr. psl. 42)

nėra pridėdama

- Ilgiklis 25 mm #13595000
- Ilgiklis 22 mm (esant nepakankamam sienos gyliui) #15597XXX, #13597XXX, #13596000, #13593XXX

**Valymas** (žr. psl. 37)**Eksplotacija** (žr. psl. 41)**Bandyimo pažyma** (žr. psl. 48)

Gedimas	Priežastis	Priemonė
Per maža srovė	- EcoSmart® purvinas arba sugedęs	- Išvalykite arba pakeiskite "EcoSmart®" (žr. psl. 38)
Sunkiai sukiojama rankenėlė	- Kasetė pažeista, užkalkėjusi	- Pakeisti kasetę
Maišytuvus praleidžia vandenį	- Kasetė pažeista	- Pakeisti kasetę
Per maža karšto vandens temperatūra, nėra šalto vandens. Momentinis pašildytas pradeda veikti, kai naudojamas šalta vanduo	- Neteisingai nustatytas karšto vandens ribotuvus - Kryžminė srovė	- Nustatyti karšto vandens ribotuvą - Pakeisti kasetę



Sigurnosne upute

- ⚠ Prilikom montaže se radi sprječavanja prignječenja i posjekotina moraju nositi rukavice.
- ⚠ Proizvod se smije primjenjivati samo za kupanje, tuširanje i osobnu higijenu.
- ⚠ Velika razlika u pritisku između vruće i hladne vode mora biti izbalansirana.

Upute za montažu

- Prije montaže mora se provjeriti je li proizvod oštećen prilikom transporta. Nakon ugradnje se ne priznaju nikakve reklamacije koje se odnose na površinska i transportna oštećenja.
- Cijevi i armatura moraju biti postavljeni, isprani i testirani prema važećim normama.
- Obvezno se moraju uvažiti propisi o instalacijama koji vrijede u dotičnoj zemlji.

Tehnički podatci

Najveći dopušteni tlak:	tlak 1 MPa
Preporučeni tlak:	0,1 - 0,5 MPa
Probni tlak:	1,6 MPa
	(1 MPa = 10 bar = 147 PSI)
Temperatura vruće vode:	tlak 60°C
Termička dezinfekcija:	70°C / 4 min
Proizvod je koncipiran isključivo za pitku vodu!	

Opis simbola



Nemojte koristiti silikon koji sadrži octenu kiselinu!



Regulacija (pogledaj stranicu 36)

Namještanje limitera tople vode. U kombinaciji s protočnim bojlerima nije preporučljiva primjena sustava za blokiranje dotoka tople vode.



Održavanje (pogledaj stranicu 38)



Mjere (pogledaj stranicu 40)



Dijagram protoka (pogledaj stranicu 41)

slobodan protok



Rezervni dijelovi

(pogledaj stranicu 42)



Posebni pribor (pogledaj stranicu 42)

Nije sadržano u isporuci!

- Produljenje 25 mm #13595000
- Produljenje 22 mm (kod manje dubine ugradnje) #15597XXX, #13597XXX, #13596000, #13593XXX



Čišćenje (pogledaj stranicu 37)



Upotreba (pogledaj stranicu 41)



Oznaka testiranja

(pogledaj stranicu 48)

Greška	Uzrok	Otklanjanje
Nedovoljno vode	- EcoSmart® je prljav/neispravan	- Očistite odnosno zamijenite EcoSmart® (pogledaj stranicu 38)
Ručica se zaglavila	- Neispravan uložak Taloženje kamena	- Zamijenite uložak
Slavina kaplje	- Neispravan uložak	- Zamijenite uložak
Preiska temperatura vruće vode, nedostatak hladne vode. Protočni bojler se pali pri podešenoj funkciji za protok hladne vode	- Limiter vruće vode nije dobro podešen - Križni tok vode	- Podesite limiter vruće vode - Zamijenite uložak





Instrucțiuni de siguranță

- ⚠ La montare utilizați mănuși pentru evitarea contuziunilor și tăierii mâinilor.
- ⚠ Produsul poate fi utilizat doar pentru spălarea, menținerea igienei și curățarea corpului.
- ⚠ Diferențele de presiune mari între alimentarea cu apă rece și apă caldă trebuie echilibrate.

Instrucțiuni de montare

- Înainte de instalare verificați, dacă produsul prezintă deteriorări de transport. După instalare garanția nu acoperă deteriorările de transport și cele de suprafață.
- Conductele și bateriile trebuie montate, spălate și verificate conform normelor în vigoare.
- Respectați reglementările referitoare la instalare valabile în țara respectivă.

Date tehnice

Presiune de funcționare:	max. 1 MPa
Presiune de funcționare recomandată:	0,1 - 0,5 MPa
Presiune de verificare:	1,6 MPa (1 MPa = 10 bar = 147 PSI)
Temperatura apei calde:	max. 60°C
Dezinfecție termică:	70°C / 4 min
Produsul este destinat exclusiv pentru apă potabilă.	

Descrierea simbolurilor



Nu utilizați silicon cu conținut de acid acetic!



Reglare (vezi pag. 36)

Reglarea limitatorului de apă caldă. Nu se recomandă folosirea unui limitator de apă caldă în combinație cu un boiler instant.



Întreținere (vezi pag. 38)



Dimensiuni (vezi pag. 40)



Diagrama de debit (vezi pag. 41)
debit cu curgere liberă



Piese de schimb (vezi pag. 42)



Accesorii opționale (vezi pag. 42)
nu este inclus în setul livrat

- Prolungitor 25 mm #13595000
- Prolungitor 22 mm (în cazul montării la adâncime mică)#15597XXX, #13597XXX, #13596000, #13593XXX



Curățare (vezi pag. 37)



Utilizare (vezi pag. 41)



Certificat de testare (vezi pag. 48)

Deranjament	Cauza	Măsurile de remediere
Prea puțină apă	- S-a murdărit / s-a defectat instalația EcoSmart®	- Curățați sau schimbați instalația EcoSmart® (vezi pag. 38)
Bateria se mișcă dificil	- Cartuș defect din cauza depunerilor de calcar	- Schimbați cartușul.
Bateria picură	- Cartuș defect	- Schimbați cartușul.
Temperatura apei este prea mică, nu este apă rece. Boilerul instant pornește când se dă drumul la apa rece	- Limitarea temperaturii apei calde setată incorect. - Curgere încrucișată (apa rece în intră în conducta de apă caldă și invers)	- Setati limitarea temperaturii apei calde. - Schimbați cartușul.



Υποδειξεις ασφαλείας

- ⚠ Για να αποφύγετε τραυματισμούς κατά τη συναρμολόγηση πρέπει να φοράτε γάντια.
- ⚠ Το προϊόν επιτρέπεται να χρησιμοποιείται μόνο σαν μέσο λουτρού, υγιεινής και καθαρισμού του σώματος.
- ⚠ Οι διαφορές της πίεσης μεταξύ της σύνδεσης κρύου και ζεστού νερού θα πρέπει να αντισταθμίζονται.

Οδηγίες συναρμολόγησης

- Πριν τη συναρμολόγηση πρέπει να εξεταστεί το προϊόν για ζημιές μεταφοράς. Μετά την εγκατάσταση δεν αναγνωρίζονται ζημιές από τη μεταφορά ή επιφανειακές ζημιές.
- Οι σωλήνες και η μπαταρία πρέπει να τοποθετηθούν σύμφωνα με τα ισχύοντα πρότυπα, να τεθούν υπό πίεση και να δοκιμαστούν.
- Θα πρέπει να τηρούνται οι οδηγίες εγκατάστασης που ισχύουν σε κάθε κράτος.

Τεχνικά Χαρακτηριστικά

Λειτουργία πίεσης:	έως 1 MPa
Συνιστώμενη λειτουργία πίεσης:	0,1 - 0,5 MPa
Πίεση ελέγχου:	1,6 MPa (1 MPa = 10 bar = 147 PSI)
Θερμοκρασία ζεστού νερού:	έως 60 °C
Θερμική απολύμανση:	70 °C / 4 min

Το προϊόν έχει σχεδιαστεί αποκλειστικά για πόσιμο νερό!.

Περιγραφή συμβόλων



Μην χρησιμοποιείτε σιλικόνη που περιέχει οξικό οξύ!



Ρύθμιση (βλ. Σελίδα 36)

Ρύθμιση του δοσομετρητή ζεστού νερού. Δεν συνιστάται η διάταξη φραγής ζεστού νερού σε συνδυασμό με ταχυθερμοσίφωνα.



Συντήρηση (βλ. Σελίδα 38)



Διαστάσεις (βλ. Σελίδα 40)



Διάγραμμα ροής (βλ. Σελίδα 41)

Ελεύθερη ροή



Ανταλλακτικά (βλ. Σελίδα 42)



Ειδικά αξεσουάρ (βλ. Σελίδα 42)

δεν περιλαμβάνεται στον παραδοτέο εξοπλισμό

- Επιμήκυνση 25 mm #13595000

- Σωλήνας επιμήκυνσης 22 mm (σε μειωμένο βάθος τοποθέτησης) #15597XXX, #13597XXX, #13596000, #13593XXX



Καθαρισμός (βλ. Σελίδα 37)



Χειρισμός (βλ. Σελίδα 41)



Σήμα ελέγχου (βλ. Σελίδα 48)

Βλάβη

Ανεπαρκές νερό

Αιτία

- Βρώμικος / ελαττωματικός ελαχιστοποιητής νερού (EcoSmart®)

Διόρθωση

- Καθαρίστε ή/και αλλάξτε τον ελαχιστοποιητή νερού (EcoSmart®) (βλ. Σελίδα 38)

Σκληρή μπαταρία (μείκτης)

- Ελαττωματικό φυσιγγίο, άλατα

- Αλλαγή φυσιγγίου

Η μπαταρία στάζει

- Ελαττωματικό φυσιγγίο

- Αλλαγή φυσιγγίου

Χαμηλή θερμοκρασία ζεστού νερού, καθόλου κρύο νερό. Ο ταχυθερμοσίφωνας ενεργοποιείται, όταν επιλέγεται το κρύο νερό.

- Λάθος ρύθμιση της περιοριστικής διάταξης ζεστού νερού

- Ρυθμίστε την περιοριστική διάταξη του ζεστού νερού

- Σταυροειδής ροή

- Αλλαγή φυσιγγίου



**Varnostna opozorila**

- ⚠ Pri montaži je treba nositi rokavice, da se preprečijo poškodbe zaradi zmečkanja ali urezov.
- ⚠ Ta izdelek se sme uporabljati le z namenom umivanja, vzdrževanja higiene in telesne nege.
- ⚠ Velike razlike v tlaku med priključkom za mrzlo in priključkom za toplo vodo je potrebno izravnati.

Navodila za montažo

- Pred montažo je treba izdelek preveriti glede morebitnih transportnih poškodb. Po vgradnji transportne ali površinske poškodbe ne bodo več priznane.
- Cevi in armaturo je treba montirati, izprati in preveriti po veljavnih standardih.
- Upoštevati je treba pravilnike o inštalacijah, ki veljajo v posamezni državi.

Tehnični podatki

Delovni tlak:	maks. 1 MPa
Priporočeni delovni tlak:	0,1 - 0,5 MPa
Preskusni tlak:	1,6 MPa (1 MPa = 10 bar = 147 PSI)
Temperatura tople vode:	maks. 60 °C
Termična dezinfekcija:	70 °C / 4 min

Proizvod je zasnovan izključno za sanitarno vodo!

Opis simbola

Ne smete uporabiti silikona, ki vsebuje ocetno kislino!



Justiranje (glejte stran 36)

Nastavitev omejevalnika tople vode. V povezavi s pretočnimi grelniki uporaba zapore tople vode ni priporočljiva.



Vzdrževanje (glejte stran 38)



Mere (glejte stran 40)



Diagram pretoka (glejte stran 41)
prost pretok



Rezervni deli (glejte stran 42)



Poseben pribor (glejte stran 42)

Ni vključeno

- Podaljšek 25 mm #13595000
- Podaljšek 22 mm (če zid ni dovolj globok) #15597XXX, #13597XXX, #13596000, #13593XXX



Čiščenje (glejte stran 37)



Upravljanje (glejte stran 41)



Preskusni znak (glejte stran 48)

Napaka	Vzrok	Pomoč
Malo vode	- EcoSmart® umazan / pokvarjen	- EcoSmart® očistite oz. Zamenjajte (glejte stran 38)
Težko premikanje armature	- Pokvarjen vložek, poapneno	- Zamenjajte vložek
Iz armature kaplja	- Pokvarjen vložek	- Zamenjajte vložek
Prenizka temperatura tople vode, ni mrzle vode. Pretočni grelnik se sproži, kadar izberete mrzlo vodo.	- Omejevalnik tople vode ni pravilno nastavljen - Križni tok	- Nastavite omejevalnik tople vode - Zamenjajte vložek



Ohutusjuhised

- △ Kandke paigaldamisel muljumis- ja löikevigastuste vältimiseks kindaid.
- △ Toodet tohib kasutada ainult pesemis-, hügieeni- ja kehapihustamiseesmärkidel.
- △ Kui külma ja kuuma vee ühenduste surve on väga erinev, tuleb need tasakaalustada.

Paigaldamisjuhised











- Enne paigaldamist tuleb toodet kontrollida transpordikahjustuste osas. Pärast paigaldamist ei tunnustata enam transpordi- või pinnakahjustuste kaebuseid.
- Voolikute ja segisti paigaldamisel, loputamisel ja kontrollimisel tuleb lähtuda kehtivatest normatiividest.
- Vastavas riigis kehtivaid paigalduseeskirju tuleb järgida.

Tehnilised andmed

Töörõhk	maks. 1 MPa
Soovitav töö rõhk:	0,1 - 0,5 MPa
Kontrollsurve:	1,6 MPa (1 MPa = 10 baari = 147 PSI)
Kuuma vee temperatuur:	maks. 60 °C
Terminline desinfitatsioon:	70 °C / 4 min

Toode on ette nähtud eranditult joogivee jaoks!

Sümbolite kirjeldus

-  Ärge kasutage äädikhapet sisaldavat silikooni!
-  **Reguleerimine** (vt lk 36)
Sooja vee piirangu seadistamine. Ühenduses boileritega ei ole sooja vee blokeeringu soovitatav.
-  **Hooldus** (vt lk 38)
-  **Mõõtude** (vt lk 40)
-  **Läbivooludiagramm** (vt lk 41)
äravoolu surve
-  **Varuosad** (vt lk 42)
-  **Spetsiaalne lisavarustus** (vt lk 42)
ei sisaldu komplektis
 - pikendus 25 mm #13595000
 - pikendus 22 mm (kui sein ei ole piisavalt paks) #15597XXX, #13597XXX, #13596000, #13593XXX
-  **Puhastamine** (vt lk 37)
-  **Kasutamine** (vt lk 41)
-  **Kontrollsertifikaat** (vt lk 48)

Rike	Põhjus	Lahendus
Vähe vett	- EcoSmart® must / defektne	- EcoSmart® puhastada või välja vahetada (vt lk 38)
Segisti käib raskelt	- Tööelement on katkine, lubjastunud	- Vahetage tööelement
Segisti tilgub	- Tööelement on katkine	- Vahetage tööelement
Liiga madal sooja vee temperatuur, külma vett pole. Läbivoolu boiler hakkab tööle, kui on valitud külm vesi.	- Kuuma vee piirang valesti seatud - Ristvool	- Seadke kuuma vee piirang - Vahetage tööelement



Drošības norādes

- ⚠ Montāžas laikā, lai izvairītos no saspiedumiem un iegriezumiem, nepieciešams nēsāt cimdus.
- ⚠ Šo produktu drīkst izmantot tikai, lai mazgātos, higiēnai un ķermeņa tīrīšanai.
- ⚠ Jāizlīdzina spiediena atšķirības starp aukstā un karstā ūdens pievadiem.

Norādījumi montāžai

- Pirms montāžas nepieciešams pārbaudīt, vai produktam transportēšanas laikā nav radušies bojājumi. Pēc iebūvēšanas bojājumi, kas radušies transportēšanas laikā, vai virsmas bojājumi netiek atzīti.
- Caurulvadi un armatūra ir jāuzstāda, jāizskalo un jāpārbauda saskaņā ar spēkā esošajiem standartiem.
- Jāievēro attiecīgās valstīs spēkā esošās montāžas prasības.

Tehniskie dati

Darba spiediens: maks. 1 MPa
 Ieteicamais darba spiediens: 0,1 - 0,5 MPa
 Pārbaudes spiediens: 1,6 MPa
 (1 MPa = 10 bar = 147 PSI)
 Karstā ūdens temperatūra: maks. 60 °C
 Termiskā dezinfekcija: 70 °C / 4 min
 Izstrādājums ir paredzēts tikai dzeramajam ūdenim!

Simbolu nozīme



Neizmantojiet silikonu, kas satur etiķskābi!



Ieregulēšana (skat. lpp. 36)

Karsta ūdens ierobežotāja regulēšana. Kopā ar caurteces sildītājiem nav ieteicams izmantot ūdens bloķētāju.



Apkope (skat. lpp. 38)



Izmērus (skat. lpp. 40)



Caurplūdes diagramma

(skat. lpp. 41)

brīva caurplūde



Rezerves daļas (skat. lpp. 42)



Speciāli aksesuāri (skat. lpp. 42)

komplektā netiek piegādāts

- Pagarinājums 25 mm #13595000
- Pagarinājums 22 mm (ja iebūvēšanas dziļums nav pietiekams) #15597XXX, #13597XXX, #13596000, #13593XXX



Tīrīšana (skat. lpp. 37)



Lietošana (skat. lpp. 41)



Pārbaudes zīme (skat. lpp. 48)

Traucējums	Iemesls	Bojājumu novēršana
Maz ūdens	- Netīrs / bojāts EcoSmart®	- Iztīrīt jeb nomainīt EcoSmart® (skat. lpp. 38)
Jaucējkrāns smagi grozāms	- Bojāta kartuša, aizkalļojusies	- Nomainīt kartušu
Jaucējkrāns pil	- Bojāta kartuša	- Nomainīt kartušu
Pārāk zema ūdens temperatūra, nav aukstā ūdens, izvēloties auksto ūdeni, sāk darboties caurteces sildītājs	- Nepareizi noregulāta karstā ūdens bloķēšana - Ūdens sajaukšanās	- Noregulēt karstā ūdens ierobežošanu - Nomainīt kartušu



Sigurnosne napomene

- ⚠ Prilikom montaže se radi sprečavanja prignječenja i posekotine moraju nositi rukavice.
- ⚠ Proizvod sme da se koristi samo za kupanje, tuširanje i ličnu higijenu.
- ⚠ Velika razlika u pritisku između vruće i hladne vode mora biti izbalansirana.

Instrukcije za montažu

- Pre montaže se mora proveriti da li je proizvod oštećen pri transportu. Nakon ugradnje se ne priznaju nikakve reklamacije koje se odnose na površinska i transportna oštećenja.
- Vodovi i armatura moraju biti postavljeni, isprani i testirani prema važećim normama.
- Treba se pridržavati propisa koji u određenim zemljama važe za instalacije.

Tehnički podaci

Radni pritisak:	maks. 1 MPa
Preporučeni radni pritisak:	0,1 - 0,5 MPa
Probni pritisak:	1,6 MPa (1 MPa = 10 bar = 147 PSI)
Temperatura vruće vode:	maks. 60 °C
Termička dezinfekcija:	70 °C / 4 min

Proizvod je koncipiran isključivo za pijaću vodu!

Opis simbola



Nemojte koristiti silikon koji sadrži sirćetnu kiselinu!



Podešavanje (vidi stranu 36)

Podešavanje ograničavača tople vode. U kombinaciji sa protočnim bojlerima ne preporučuje se primena sistema za blokiranje dotoka tople vode.



Održavanje (vidi stranu 38)



Mere (vidi stranu 40)



Dijagram protoka (vidi stranu 41)

slobodan protok



Rezervni delovi (vidi stranu 42)



Poseban pribor (vidi stranu 42)

Nije sadržano u isporuci

- Produžetak 25 mm #13595000
- Produžetak 22 mm (kod manje dubine ugradnje) #15597XXX, #13597XXX, #13596000, #13593XXX



Čišćenje (vidi stranu 37)



Rukovanje (vidi stranu 41)



Ispitni znak (vidi stranu 48)

Smetnja	Uzrok	Pomoć
Nedovoljno vode	- EcoSmart® je prljav / neispravan	- Očistite odnosno zamenite EcoSmart® (vidi stranu 38)
Ručica se zaglavila	- Neispravna kartuša, nataloženi kamenac	- Zamenite kartušu
Slavina kaplje	- Neispravna kartuša	- Zamenite kartušu
Preiska temperatura tople vode, nema hladne vode. Protočni bojler se pali iako je puštena hladna voda.	- Ograničavač vruće vode nije dobro podešen - Ukršteni tok vode	- Podesite ograničavač vruće vode - Zamenite kartušu





Sikkerhetshenvisninger

- ⚠ Bruk hansker under montasjen for å unngå klem- og kuttskader.
- ⚠ Produktet skal kun brukes for bade-, hygiene- og kroppshygiene.
- ⚠ Store trykkdifferanser mellom kaldt- og varmtvannstilkoblinger skal utlignes.

Montagehenvisninger

- Før montasjen skal produktet sjekkes for transportskader. Etter monteringen aksepteres ikke noen transport- eller overflateskader.
- Ledningene og armaturen skal monteres, spyles og sjekkes iht. de gyldige normer.
- Gjeldende retningslinjer for rørleggerarbeid i de enkelte land skal følges.

Tekniske data

Driftstrykk	maks. 1 MPa
Anbefalt driftstrykk:	0,1 - 0,5 MPa
Prøvetrykk	1,6 MPa
	(1 MPa = 10 bar = 147 PSI)
Varmtvannstemperatur	maks. 60 °C
Termisk desinfisering:	70 °C / 4 min
Produktet er utelukkende designet for drikkevann!	

Symbolbeskrivelse

Ikke bruk silikon som inneholder eddiksyre!

Justering (se side 36)

Innstilling av varmtvannsbegrensning. I forbindelse med gjennomstrømningsvarmere er det ikke anbefalt å bruke en varmtvannssperre.

Vedlikehold (se side 38)

Mål (se side 40)

Gjennomstrømningsdiagram
(se side 41)

fri gjennomstrømning

Service-deler (se side 42)

Ekstratilbehør (se side 42)

ikke med i leveransen

- Forlengelse 25 mm #13595000

- Forlengelse 22 mm (ved liten montasjedybde) #15597XXX, #13597XXX, #13596000, #13593XXX

Rengjøring (se side 37)

Betjening (se side 41)

Prøvemerk (se side 48)

Feil	Årsak	Feilrettelse
Lite vann	- EcoSmart® er skitten / defekt	- EcoSmart® rengjøres hhv. Byttes (se side 38)
Armatur ikke lett bevegelig	- Kartusj defekt, forkalkning	- Kartusj byttes
Armatur drypper	- Kartusj defekt	- Kartusj byttes
For lav varmtvannstemperatur, ikke noe kaldvann. gjennomstrømningsvarmer slår seg på når det velges kaldt vann.	- Varmtvannsbegrensning er feil innstilt	- Varmtvannsbegrensning innstilles
	- Krysstrømning	- Kartusj byttes



Указания за безопасност

- ⚠ При монтажа трябва да се носят ръкавици, за да се избегнат наранявания поради притискане или порязване.
- ⚠ Позволено е използването на продукта само за къпане, хигиена и цели на почистване на тялото.
- ⚠ Големите разлики в налягането между изводите за студената и топлата вода трябва да се изравняват.

Указания за монтаж

- Преди монтажа продуктът трябва да се провери за транспортни щети. След монтажа не се признават транспортни или повърхностни щети.
- Тръбопроводите и арматурата трябва да се монтират, промият и проверят в съответствие с валидните норми.
- Трябва да бъдат спазвани валидните в съответните страни предписания за инсталиране.

Технически данни

Работно налягане: макс. 1 МПа
 Препоръчително работно налягане: 0,1 - 0,5 МПа
 Контролно налягане: 1,6 МПа
 (1 МПа = 10 bar = 147 PSI)
 Температура на горещата вода: макс. 60°C
 Термична дезинфекция: 70°C / 4 мин
 Продуктът е разработен само за питейна вода!

Описание на символите



Не използвайте силикон, съдържащ оцветна киселина!



Юстиране (вижте стр. 36)

Настройка на ограничителя за топлата вода. Във връзка с проточни нагреватели не се препоръчва блокировка за топлата вода



Поддръжка (вижте стр. 38)



Размери (вижте стр. 40)



Диаграма на потока (вижте стр. 41)

свободен поток



Сервизни части (вижте стр. 42)



Специални принадлежности (вижте стр. 42)

не се съдържа в обема на доставка

- Удължител 25 мм #13595000

- Удължител 22 мм (при малка монтажна дълбочина) #15597XXX, #13597XXX, #13596000, #13593XXX



Почистване (вижте стр. 37)



Обслужване (вижте стр. 41)



Контролен знак (вижте стр. 48)

Неизправност	Причина	Помощ
Малко вода	- Замярсен / дефектен EcoSmart®	- Почистете респ. сменете EcoSmart® (вижте стр. 38)
Трудно подвижна арматура	- Дефектна гилза, покрита с варовик	- Сменете гилзата
Арматурата капе	- Дефектна гилза	- Сменете гилзата
Твърде ниска температура на топлата вода, няма студена вода.	- Ограничението за топлата вода е грушно настроено	- Настройте ограничението за топлата вода
Проточният нагревател се задейства, когато се избере студена вода	- Кръстосване на потока	- Сменете гилзата

**安全上の注意**

- △ 施工の際は手を挟んだり怪我をしないように、手袋をはめてください。
- △ この製品は、体や手を洗う等の製品本来の目的以外には使用しないでください。
- △ 給水・湯の圧力差は0.1(MPa)以内としてください。

施工上の注意

- 製品の施工前に輸送でのダメージがないか確認してください。施工後のキズ等のお申し出はお断りさせていただきます。
- 配管と水栓は、関連法規に従って施工、洗浄、および試験を行ってください。
- 施工行う地域に適用される関連法規をお守りください。

技術資料

使用圧力:	最大 1 MPa
推奨使用水圧:	0,1 - 0,5 MPa
耐圧試験圧力:	1,6 MPa (1 MPa = 10 bar = 147 PSI)
給湯温度:	最大 60°C
お湯による高温消毒:	70°C / 4分

この製品は飲料水での使用が前提となっています(日本においては水道法に適合する飲料水)!

アイコンの説明

酢酸系シリコンをご使用にならないでください!



調整 (次のページを参照 36)

お湯の流量制限の設定方法。瞬間湯沸かし器をご利用の際はお湯の流量制限はしないでください。



メンテナンス (次のページを参照 38)



寸法 (次のページを参照 40)



流量曲線図 (次のページを参照 41)

何も接続しない時の吐水



スペアパーツ (次のページを参照 42)



スペシャルパーツ

(次のページを参照 42)

別手配部品

- 25 mm延長部材 #13595000

- 22 mm延長部材 (壁裏が浅い場合) #15597XXX, #13597XXX, #13596000, #13593XXX



お手入れ方法

(次のページを参照 37)



使用方法 (次のページを参照 41)



認証について (次のページを参照 48)

症状	原因	対応策
流量が少ない	- EcoSmart®の汚れ/不具合	- EcoSmart®を清掃または交換してください (次のページを参照 38)
水栓の開閉が重い	- カルキによるカートリッジ不具合	- カートリッジを交換してください
水栓の水漏れ	- カートリッジの不良	- カートリッジを交換してください
吐水温度が低すぎる, 水が出ない。冷水を選択すると、瞬間湯沸かし器が起動する。	- 温度リミッターの設定が正しくない - クロスコネクション	- 温度リミッターを設定してください - カートリッジを交換してください



Shqip

Udhëzime sigurie

- △ Për të evituar lëndimet e pickimeve ose të prerjeve gjatë procesit të montimit duhet që të vishni doreza.
- △ Produkti duhet të përdoret vetëm qëllimet e banjave, të higjienës dhe të larjes së trupit.
- △ Ndryshimet e mëdha të presionit mes lidhjeve të ujit të ftohtë dhe atij të ngrohtë duhen ekuilibruar.

Udhëzime për montimin

- Përpara montimit duhet që produkti të kontrollohet për dëmtime nga transporti. Pas instalimit nuk do të njihet asnjë dëmtim nga transporti ose dëmtim i sipërfaqes.
- Tubacionet dhe rubinetet duhet që të montohen, të shpëlajen dhe të kontrollohen sipas standardeve në fuqi
- Duhet të respektohen linjat udhëzuese të instalimit, të vlefshme për vendet respektive.

Të dhëna teknike

Presioni gjatë punës	maks. 1 MPa
Presioni i rekomanduar:	0,1 - 0,5 MPa
Presioni për provë:	1,6 MPa
	(1 MPa = 10 bar = 147 PSI)
Temperatura e ujit të ngrohtë	maks. 60 °C
Dezinfektim Termik:	70 °C / 4 min
Produkti është projektuar ekskluzivisht për ujë të pijshëm!	

Përshkrimi i simbolit



Mos përdorni silikon që në përbërje ka acid acetik.



Justimi (shih faqen 36)

Rregullimi i kufizimit me ujë të nxehtë. Një kombinim me një bojler ujit nuk është i rekomanduar.



Mirëmbajtja (shih faqen 38)



Përmasat (shih faqen 40)



Diagrami i qarkullimit

(shih faqen 41)

rrjedhja e lirë



Pjesët e servisit (shih faqen 42)



Pajisje të posaçme (shih faqen 42)

nuk përfshihet në vëllimin e furnizimit

- Zgjatësi 25 mm #13595000

- Zgjatësi 22 mm (lartësia e montimit jo e madhe) #15597XXX, #13597XXX, #13596000, #13593XXX



Pastrimi (shih faqen 37)



Përdorimi (shih faqen 41)



Shenja e kontrollit (shih faqen 48)

Demtim	Shkaku	Ndihme
Pak ujë	- EcoSmart® është i ndotur/ defekt	- Pastroni / këmbeni EcoSmart® (shih faqen 38)
Armatura punon rende	- Kartusha me defekt, me kalk	- Këmbeni kartushen
Armatura pikon	- Kartusha me defekt	- Këmbeni kartushen
Temperaturë e ulët e ujit të ngrohtë, nuk ka ujë të ftohtë. Ngrohësi elektrik i ujit ndizet kur zgjidhet uji i ftohtë.	- Kufiri i ujit të ngrohtë është regjistruar gabim	- Regjistroni kufirin e ujit të ngrohtë
	- Rrjedhje e kryqëzuar.	- Këmbeni kartushen

وصف الرمز

هام! لا تستخدم السليكون الذي يحتوي على أحماض! 

الضبط (راجع صفحة 36) 

ضبط تحديد المياه الدافئة. لا ينصح باستخدام محدد المياه الدافئة مع سخان المياه الوتقي.

الصيانة (راجع صفحة 38) 

أبعاد (راجع صفحة 40) 

رسم للصرف (راجع صفحة 41) 

التدفق الحر

قطع الغيار (راجع صفحة 42) 

ملحقات خاصة (راجع صفحة 42) 

غير مدرج مع المحتويات المسلمة

• وصلة إطالة 25 مم #13595000

• طقم الملحقات 22 مم (عندما لا يكون الجدار

عميقًا بما يكفي)، #13597XXX، #13597XXX

#13596000، #13593XXX

التنظيف (راجع صفحة 37) 

التشغيل (راجع صفحة 41) 

شهادة اختبار (راجع صفحة 48) 

تنبهات الأمان

⚠ يجب إرتداء قفازات لليد أثناء التركيب لتجنب حدوث أخطار الإنحشار أو الجروح.

⚠ لا يجب استخدام المنتج إلا في أغراض الاستحمام والأغراض الصحية وأغراض تنظيف الجسم.

⚠ يجب أن يكون تيار الماء الساخن والماء البارد متعادلين في الضغط.

تعليمات التركيب

- قبل القيام بعملية التركيب، يجب فحص المنتج للتأكد من خلوه من أية تلفيات ناتجة عن النقل. بعد القيام بعملية التركيب، لن يتم الاعتراف بوجود أية تلفيات سطحية أو تلفيات ناتجة عن عملية النقل.
- يجب تركيب وغسيل واختبار التوصيلات وخلطات المياه طبقاً للمعايير السارية.
- يجب مراعاة القواعد الخاصة بالتركيب وأعمال السباكة وفقاً للوائح الخاصة بكل بلد.

المواصفات الفنية

ضغط التشغيل: الحد الأقصى 1 ميجاباسكال
 ضغط التشغيل الموصى به: 0,5 - 0,1 ميجاباسكال
 ضغط الاختبار: 1,6 ميجاباسكال
 (1 ميجاباسكال = 10 بار = 147 PSI)
 درجة حرارة الماء الساخن: الحد الأقصى 60°C
 تعقيم حراري: 70°C / 4 الدقيقة
 المنتج مخصص فقط لماء الشرب!

العلاج والإصلاح

السبب

العطل

- وحدة ترشيد استهلاك المياه متسخة / - قم بتنظيف أو تغيير وحدة توفير المياه (راجع صفحة 38) تالفة

- الخرطوشة تالفة، تراكم عليها الجير - قم بتغيير الخرطوشة

- الخرطوشة تالفة - قم بتغيير الخرطوشة

- محدد الماء الساخن مضبوط بشكل خاطيء - قم بضبط محدد الماء الساخن

- اندفاع متعكس للمياه - قم بتغيير الخرطوشة

الماء غير كافٍ

الخلاط ثقيل الحركة

تساقط قطرات مياه من الخلاط

درجة حرارة الماء الساخن منخفضة للغاية، ولا يوجد ماء بارد. سخان المياه الفوري يعمل عند استخدام الماء البارد.

Güvenlik uyarıları

- △ Montaj esnasında ezilme ve kesilme gibi yaralanmaları önlemek için eldiven kullanılmalıdır.
- △ Ürün yalnızca banyo, hijyen ve beden temizliği amaçları doğrultusunda kullanılabilir.
- △ Sıcak ve soğuk su bağlantıları arasında büyük basınç farklılıkları varsa, bu basınç farklılıklarının dengelenmesi gerekir.

Montaj açıklamaları







- Montaj işleminden önce ürün nakliye hasarları yönünden kontrol edilmelidir. Montaj işleminden sonra nakliye veya yüzey hasarları için sorumluluk üstlenilmemektedir.
- Boruların ve armatürün montajı, yıkanması ve kontrolü geçerli normlara göre yapılmalıdır.
- Ülkelerde geçerli kurulum yönetmeliklerine riayet edilmelidir.

Teknik bilgiler

İşletme basıncı:	azami 1 MPa
Tavsiye edilen işletme basıncı:	0,1 - 0,5 MPa
Kontrol basıncı:	1,6 MPa
	(1 MPa = 10 bar = 147 PSI)

Sıcak su sıcaklığı:	azami 60 °C
Termik dezenfeksiyon:	70 °C / 4 dak
Ürün sadece şebeke suyu için tasarlanmıştır!	

Simge açıklaması

-  Asetik asit içeren silikon kullanmayın!
-  **Ayarlama** (bakınız sayfa 36)
Sıcak su sınırlamasının ayarlanması. Sıcak su kilidinin sürekli ısıtıcıyla kullanılması tavsiye edilmez.
-  **Bakım** (bakınız sayfa 38)
-  **Ölçüleri** (bakınız sayfa 40)
-  **Akış diyagramı** (bakınız sayfa 41)
serbest akış
-  **Yedek Parçalar** (bakınız sayfa 42)



Özel aksesuarlar (bakınız sayfa 42)

Teslimat kapsamına dahil değildir

- Uzatma 25 mm #13595000
- Uzatma 22 mm (montaj derinliği düşükken) #15597XXX, #13597XXX, #13596000, #13593XXX



Temizleme (bakınız sayfa 37)



Kullanımı (bakınız sayfa 41)



Kontrol işareti (bakınız sayfa 48)

Garanti Belgesi

Üretici veya İthalatçı Firmanın

Unvanı:	Hansgrohe Armatür Ltd. Şti
Adresi:	Fulya Mahallesi Bahçeler Sokak Efe han 20/C Mecidiyeköy Şişli İstanbul (0-212) 273 07 30 (0-212) 273 07 40 www.hansgrohe.com.tr
Telefonu:	
Faks:	
web adresi:	

Malın

Markası:	Hansgrohe
Cinsi:	Sihhi tesisat malzemesi
Garanti Süresi:	2 YIL
Azami Tamir Süresi:	20 İş günü

Genel Müdür

Albert Emlek

Satıcı Firmasının:
Unvanı:
Adresi:
Telefonu:
Faks:
e-posta:
Fatura Tarih ve Sayısı:
Marka ve Modeli:
Teslim Tarihi ve Yeri:
Yetkilinin İmzası:
Firmanın Kaşesi:

Bu bölümü, ürünü aldığımız Yetkili Satıcı imzalayacak ve kaşeleyecektir.

arıza

sebeb

yardım

Az su geliyor	- EcoSmart® kirlenmiş / arızalı	- EcoSmart®'ı temizleyin ya da değiştirin (bakınız sayfa 38)
Batarya kullanımı ağırlaşıyor	- Kartuş Bozulmuş ve kireçlenmiş olabilir	- Kartuşu değiştirin
Batarya su damlatıyor	- Kartuş bozuk olabilir	- Kartuşu değiştirin
Sıcak su sıcaklığı çok düşük, soğuk su yok.	- Isı limitleyici düzgün çalışmıyor	- Isı limitleyiciyi yeniden ayarlayın
Soğuk su seçilince şofben çalışmaya başlıyor.	- Çapraz akış	- Kartuşu değiştirin

Montajı (bakınız sayfa 34)





הערות בטיחות

- ⚠ יש להשתמש בכפפות בזמן ההתקנה כדי למנוע פציעות וחתכים
- ⚠ המוצר מיועד לשימוש למטרות רחצה, היגיינה ושטיפת הגוף בלבד
- ⚠ למערכת המים החמים והקרים צריכים להיות לחצים שווים



הוראות התקנה

- לפני ההתקנה, בדוק אם נגרמו למוצר נזקים בהובלה אחרי ההתקנה, לא נכיר בנזקים שנגרמו בהובלה או בנזקים במשטחים
- חובה להתקין את הצינורות והאביזרים, לשטוף אותם ולבדוק אותם על פי התקנים הישימים
- צריך לפעול על פי חוקי השרברבות הישימים במדינת ההתקנה

נתונים טכניים

- לחץ הפעלה: מקסימום 1 MPa
- לחץ פעולה מומלץ: MPa 0,5 - 0,1
- לחץ בדיקה: MPa 1,6
- (1 MPa = 10 bar = 147 PSI)
- טמפרטורת מים חמים: מקסימום 60°C
- חיטוי תרמי: 70°C / 4 דקות
- המוצר מיועד אך ורק למי שתיה!

תיאור הסמל

אסור להשתמש בסליקון המכיל חומצה אצטית! 
כוונון (ראה עמוד 36) 
 כדי להתאים את מגביל המים החמים. לא מומלץ להשתמש במגביל מים חמים ביחד עם מחמם מים בעל זרימה רצופה.

תחזוקה (ראה עמוד 38) 

מידות (ראה עמוד 40) 

דיאגרמת זרימה (ראה עמוד 41) 
 זרימה חופשית

חלקי חילוף (ראה עמוד 42) 

אביזרים מיוחדים (ראה עמוד 42) 
 הזמנה של פריט אקסטרה

• הארכה 25 מ"מ #13595000

• סט הארכה 22 מ"מ (כשהקיר עמוק מספיק), #13597XXX, #15597XXX
 #13596000, #13593XXX

ניקוי (ראה עמוד 37) 

הפעלה (ראה עמוד 41) 

תעודת בדיקה (ראה עמוד 48) 

תקלה	סיבה	אופן התיקון
אין מספיק מים	- מגביל הזרימה EcoSmart מלוכלך או דולף	- נקה או החלף את EcoSmart® (ראה עמוד 38)
ברז ערבוב נוקשה	- מנגנון ערבוב לא תקין, אבנית	- החלף מנגנון ערבוב
טפטוף מברז ערבוב	- מנגנון ערבוב לא תקין	- החלף מנגנון ערבוב
טמפרטורת המים החמים נמוכה מדי, אין מים קרים. מחמם המים המייד	- מגביל המים החמים לא נקבע נכון	- קבע את מגביל המים החמים
נדלק כשבוחרים במים קרים	- זרם צולב	- החלף מנגנון ערבוב



Biztonsági utasítások

- △ A szerelésnél a zúzódások és vágási sérülések elkerülése érdekében kesztyűt kell viselni.
- △ A terméket csak fürdéshez, mosakodáshoz, és egészségügyi tisztálkodáshoz szabad használni.
- △ A hidegvíz- és a melegvíz-csatlakozások közötti nagy nyomáskülönbséget kikell egyenlíteni!

Szerelési utasítások

- A szerelés előtt ellenőrizni kell, hogy a terméknek nincs-e szállítási sérülése. Beépítés után a szállítási vagy felületi sérüléseket nem ismerik el.
- A vezetékeket és a csaptelepet az érvényes szabványoknak megfelelően kell felszerelni, öblíteni és ellenőrizni
- Az egyes országokban érvényes installációs irányelveket be kell tartani.

Műszaki adatok

Üzemi nyomás:	max. 1 MPa
Ajánlott üzemi nyomás:	0,1 - 0,5 MPa
Nyomáspróba:	1,6 MPa
	(1 MPa = 10 bar = 147 PSI)
Forróvíz hőmérséklet:	max. 60 °C
Termikus fertőtlenítés:	70 °C / 4 perc

A terméket kizárólag ivóvízhez tervezték!

Szimbólumok leírása



Ne használjon ecetsavtartalmú szilikont!



Beállítás (lásd a oldalon 36)

A meleg víz korlátozás beállítása. Átfolyós vízmelegítőknél meleg víz korlátozó használata nem ajánlott.



Karbantartás (lásd a oldalon 38)



Méretet (lásd a oldalon 40)



Átfolyási diagramm

(lásd a oldalon 41)

szabad átfolyás



Tartozékok (lásd a oldalon 42)



Egyéb tartozék (lásd a oldalon 42)

a szállítási egység nem tartalmazza

- Hosszabbítás 25 mm #13595000
- Hosszabító készlet 22 mm (kis beépítési mélység esetén)#15597XXX, #13597XXX, #13596000, #13593XXX



Tisztítás (lásd a oldalon 37)



Használat (lásd a oldalon 41)

- A csaptelepeken átfolyt víz hőmérséklete fogyasztásra szánt víz esetében a 65 °C-ot nem haladhatja meg. A csaptelep nem eredményezheti az emberi fogyasztásra (pl. ivás és főzés céljából) szánt víz minőségromlását.
- Beüzemelés és üzemszünetek után szigorúan be kell tartani a használati útmutatóban leírtakat. Beüzemeléskor a csaptelepet át kell öblíteni, legalább 2 percig történő hideg- és melegvízes folytatást javasunk. Minimum 1 napos üzemszünet után fogyasztás előtt a csaptelepben stagnáló hideg- illetve melegvíz fogyasztása nem javasolt, a csaptelepben stagnáló vizet ki kell engedni, legalább 2 perces folytatás javasolt. A kifolytatás során nyert vizet ivóvízként, illetve ételkészítési céllal felhasználni nem szabad.
- Tekintettel arra, hogy a forró víz fémoldó képessége a hideg vízénél nagyobb, emiatt főzés ivás céljából az OKI a hideg víz használatát javasolja.
- A csaptelepek perlatorát javasolt havonta vízköteleníteni, illetve fertőtleníteni. A csaptelepek tisztítása, fertőtlenítése során kizárólag olyan vegyszer alkalmazható, amely megfelel a 201/2001. (X.25) Kormányrendelet, illetve a 38/2003. (VII.7) ÉSzCsM-FVM-KvVM együttes rendeletben leírtaknak.
- A perlator működési elvéből adódóan jelentős aeroszolt képez, így Legionella expozíció szempontjából fokozott kockázatot jelent. Ezért alkalmazása nem javasolt az egészségügyi intézmények fekvőbeteg ellátó szobáiban, illetve minden olyan helyen, ahol a hideg és / vagy használati melegvíz Legionella csírszáma eléri a 49/2015 (XI.6.) EMMI rendelet alapján meghatározott beavatkozási szintet.



Vizsgajel (lásd a oldalon 48)



Hiba	Ok	Megoldás
Kevés víz	- EcoSmart® elszennyeződött / meghibásodott	- EcoSmart® tisztítása, ill. Cseréje (lásd a oldalon 38)
Nehezen nyitható a csap.	- A kerámiabetét meghibásodott, elvízkövesedett.	- A kerámiabetétet ki kell cserélni.
Csöpög a csap.	- A kerámiabetét meghibásodott.	- A kerámiabetétet ki kell cserélni.
Túl alacsony melegvíz hőmérséklet, nincs hidegvíz. A hidegvíz kiválasztásakor beindul az átfolyós melegítő.	- A melegvíz szabályozó rosszul van beállítva. - Keresztfolyás	- A melegvíz szabályozót újra be kell állítani. - A kerámiabetétet ki kell cserélni.

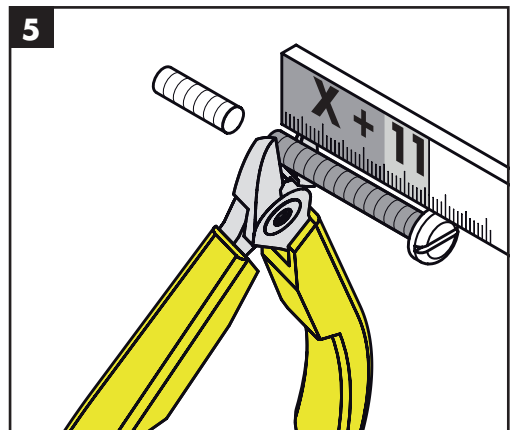
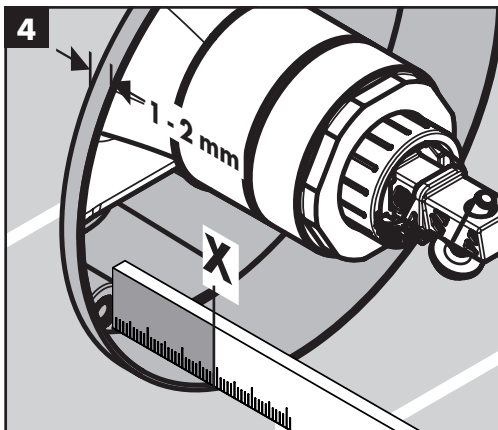
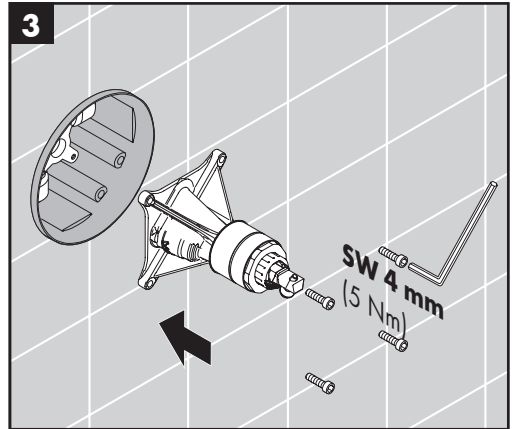
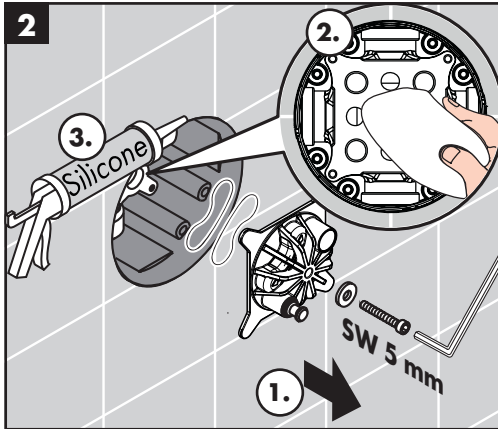
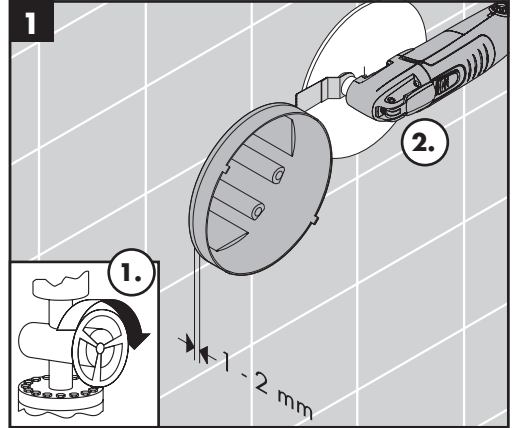
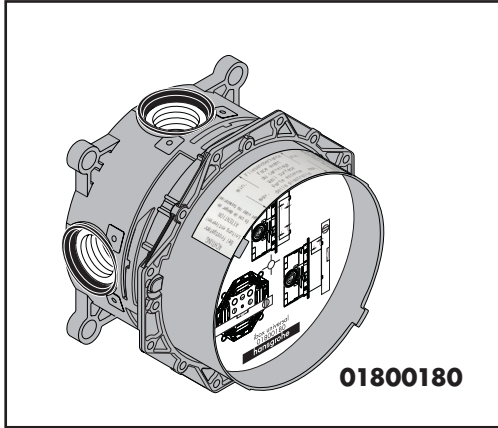

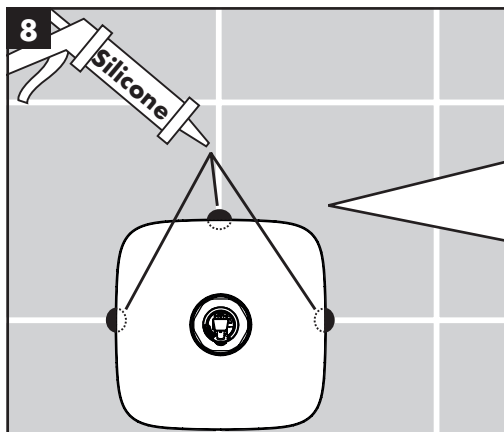
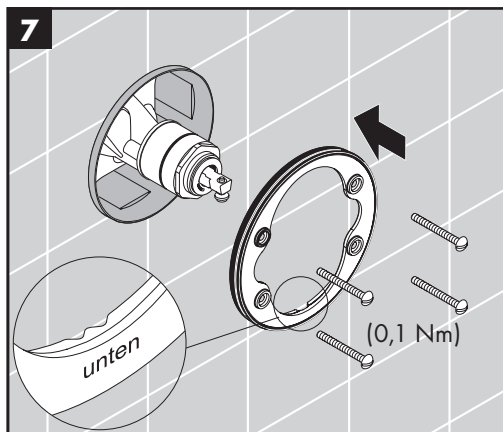
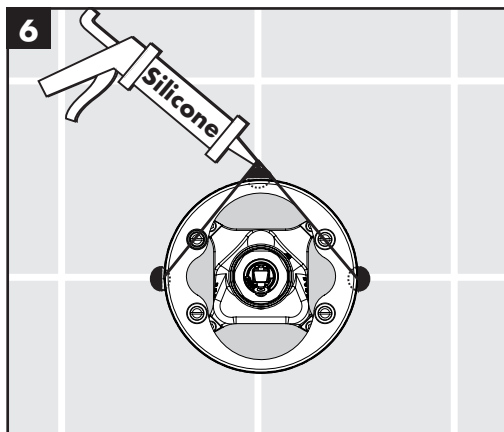

PuraVida 15665XXX

Metris 31456000

Logis 71605000

Logis Loop 71267000

Talis E 71765XXX

Vernis Shape 71668XXX

Metropol 32565XXX / 74565000

Vivenis 75615XXX

Finoris 76615XXX

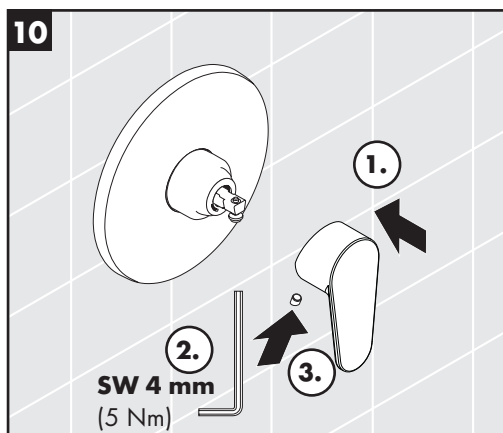
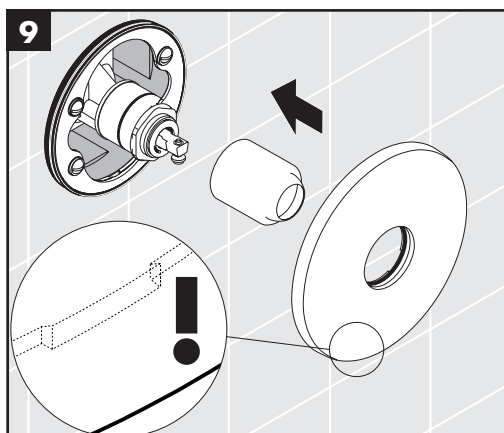

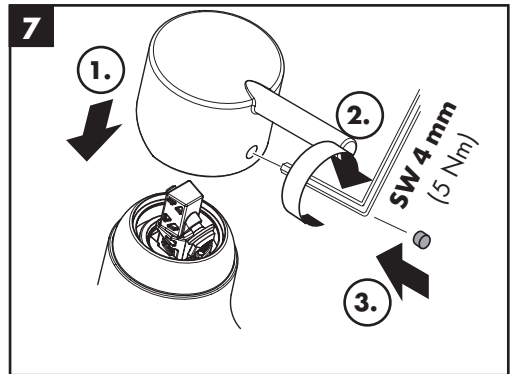
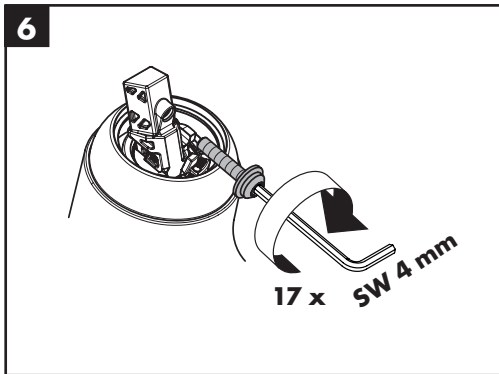
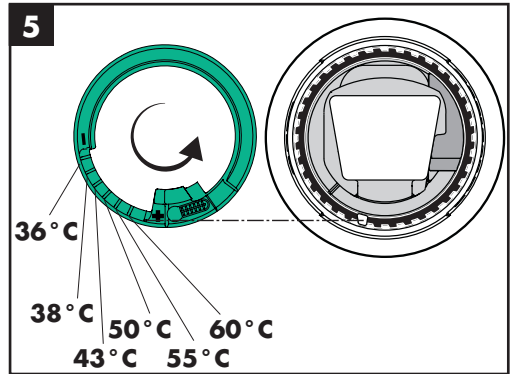
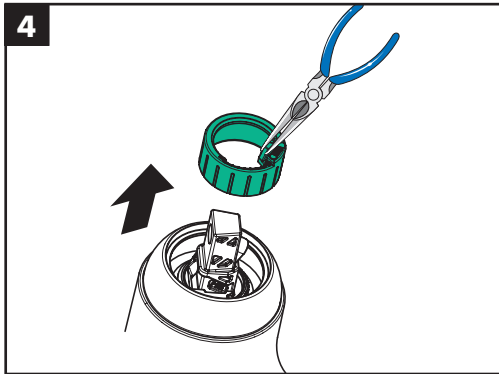
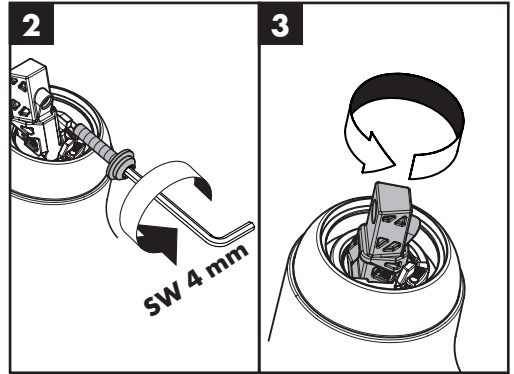
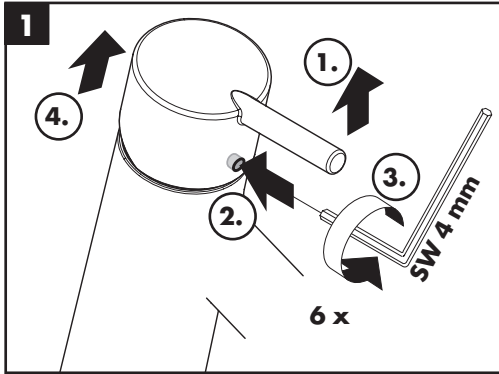



www.hansgrohe.com/cleaning-recommendation

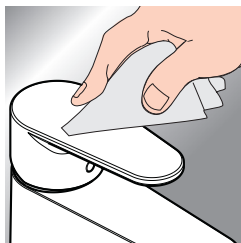

- DE** Reinigungsempfehlung / Garantie / Kontakt
- FR** Recommendation pour le nettoyage / Garanties / Contact
- EN** Cleaning recommendation / Warranty / Contact
- IT** Raccomandazione di pulizia / Garanzia / Contatto
- ES** Recomendaciones para la limpieza / Garantía / Contacto
- NL** Aanbevelingen inzake reiniging / Garantie / Contact
- DK** Rengøringsvejledning / Garanti / Kontakt
- PT** Recomendações de limpeza / Garantia / Contacto
- PL** Zalecenie dotyczące pielęgnacji / Gwarancja / Kontakt
- CS** Doporučení k čištění / Záruka / Kontakt
- SK** Odporúčania pre čistenie / Záruka / Kontakt
- ZH** 清洁指南 / 担保 / 接触
- RU** Рекомендации по очистке / Гарантия / Контакты
- FI** Puhdistussuositus / Takuu / Kosketus

- SV** Rengöringsrekommendationer / Garanti / Contacto
- LT** Valymo rekomendacijos / Garantija / Kontaktai
- HR** Preporuke za čišćenje / Garancija / Kontakt
- RO** Recomandări pentru curățare / Garanție / Contact
- EL** Σύσταση καθαρισμού / Εγγύηση / επαφή
- SL** Priporočilo za čiščenje / Garancija / Kontakt
- ET** Puhastussoovitused / Garantii / Kontakt
- LV** Tīrīšanas ieteikumi / Garantija / Kontakti
- SR** Preporuke za čišćenje / Garancija / Kontakt
- NO** Anbefaling for rengjøring / Garanti / Kontakt
- BG** Препоръка за почистване / Гаранция / Контакт
- JP** お手入れの方法 / 保証について / ご連絡先
- SQ** Këshilla rreth pastrimit / Garancia / Kontakt
- AR** توصيات التنظيف / الضمان / اتصال
- TR** Temizleme önerisi / Garanti / Temas
- HU** Tisztítási tanácsok / Garancia / érintkezés
- HE** המלצות לניקוי / אחריות / איש קשר



Metris 31685000
Focus 31965000
Metris 31456000
PuraVida 15665XXX
Metropol Classic 31365XXX
Talis S/Talis 32675XXX
Talis S 72605000
Talis E 71765XXX
Vernis Blend 71667XXX
Vernis Shape 71668XXX

Logis Loop 71267000
Metris S 31665000
Talis Classic 14165000
Logis 71605000
Metropol 32565XXX
Metropol 74565000
Vivenis 75615XXX
Finoris 76615XXX
Metris 31685000

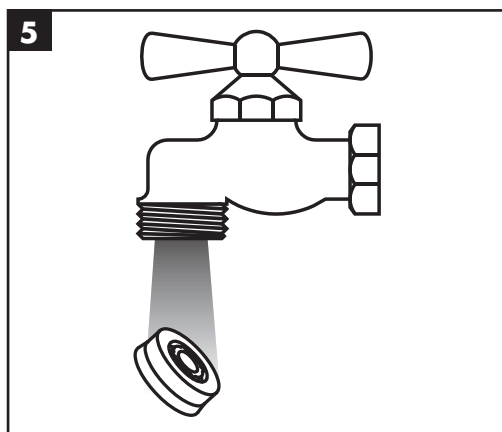
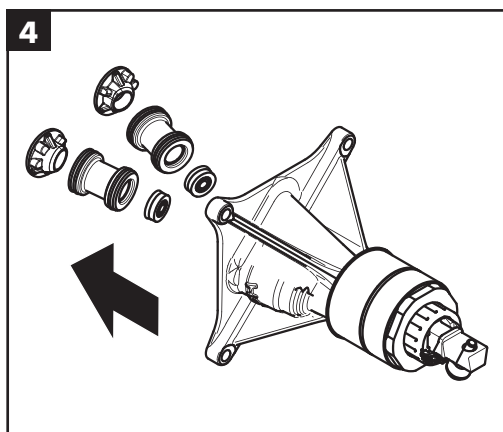
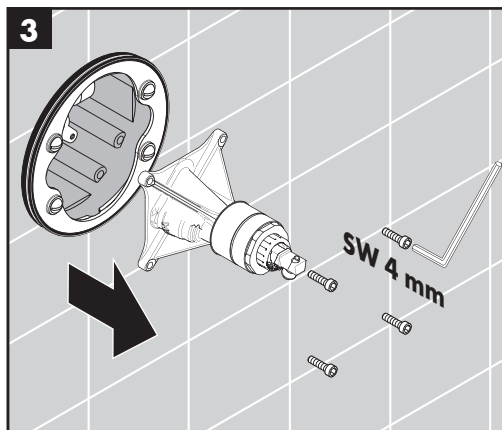
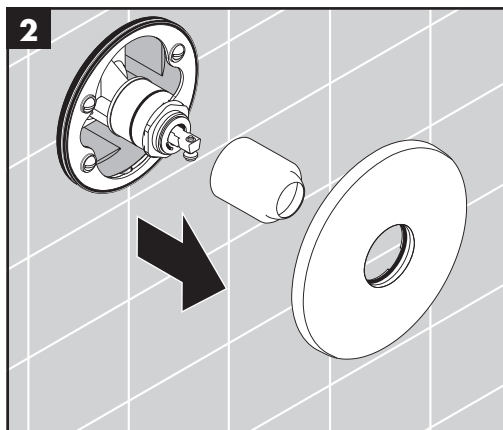
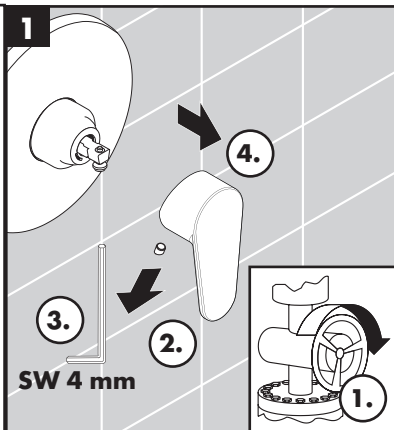

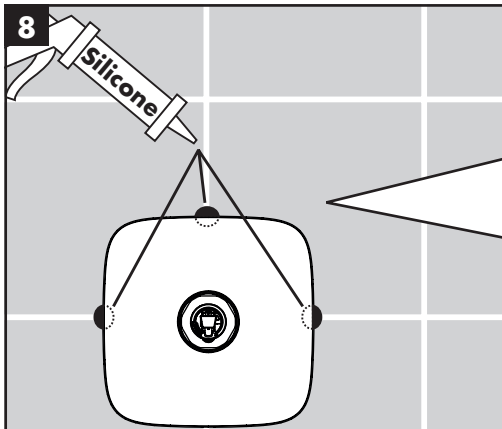
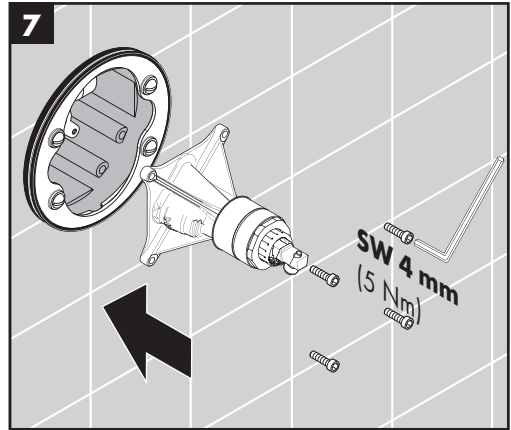
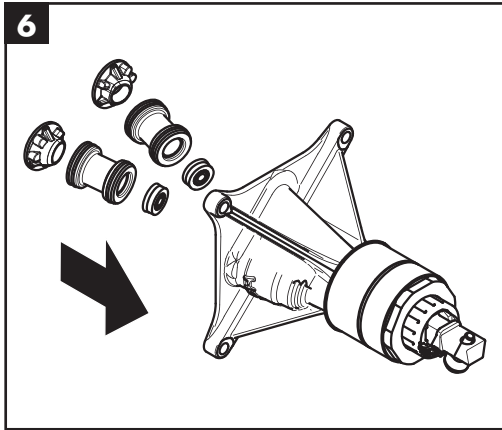

PuraVida 15665XXX
Metris 31456000
Logis 71605000
Logis Loop 71267000
Talis E 71765XXX
Vernis Shape 71668XXX
Metropol 32565XXX / 74565000
Vivenis 75615XXX
Finoris 76615XXX

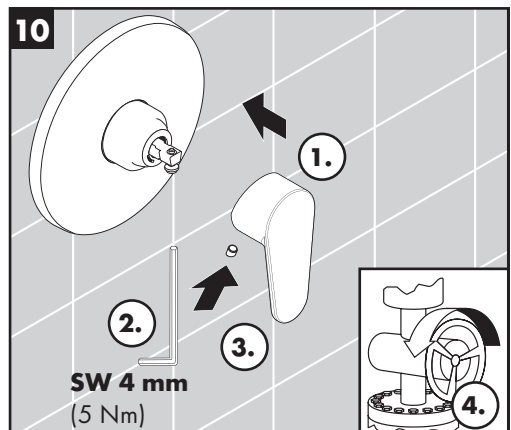
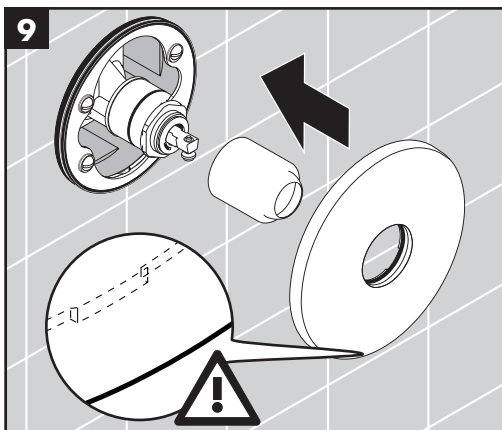

**Talis Classic**

14165000

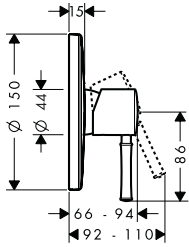
**PuraVida**

15665XXX

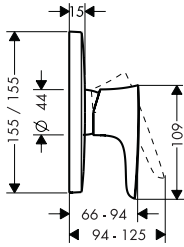
**Metropol Classic**

31365XXXX

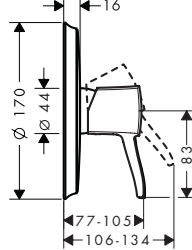
**Metris**

31456000

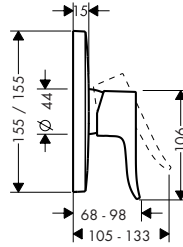
**Metris S**

31665000

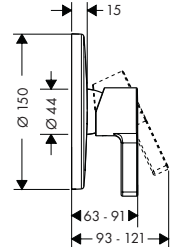
**Talis S / Talis**

32675XXX

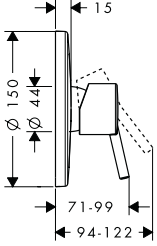
**Metris**

31685000

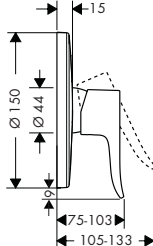
**Focus**

31965000

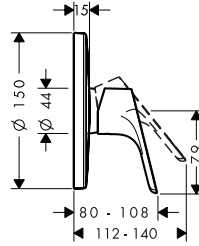
**Talis S**

72605000

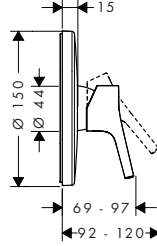
**Logis Loop**

71267000

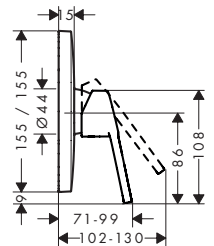
**Logis E**

71603000

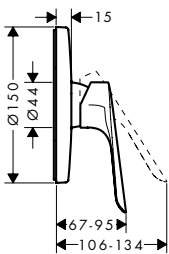
**Talis E**

71765XXX

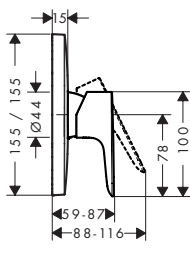
**Logis**

71605000

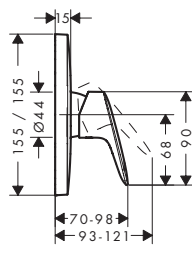
**Vernis Blend**

71667XXX

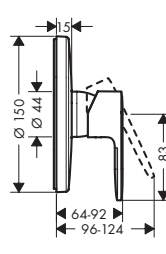
**Vernis Shape**

71668XXX

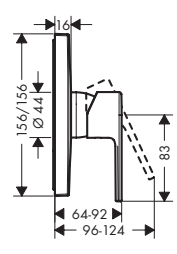
**Metropol**

32565XXX

74565000

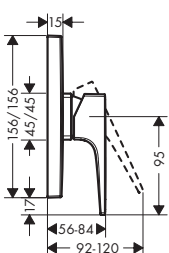
**Novus**

71065000

71065003

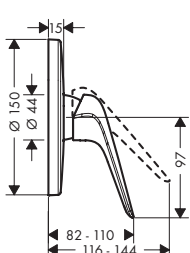
**Novus Loop**

71365000

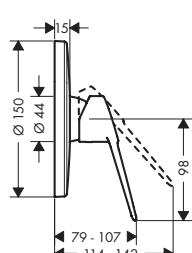
**Vivenis**

75615XXX

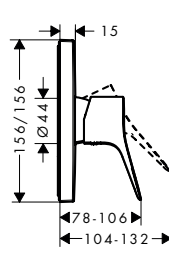
**Finoris**

76615XXX

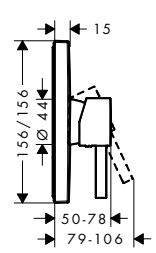



Rebris S Rebris E
72667XXX 72668XXX

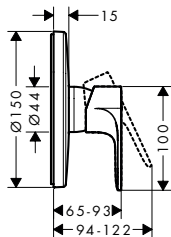

PuraVida 15665XXX
Metris 31456000
Logis 71605000
Talis E 71765XXX
Logis Loop 71267000
Talis Classic 14165000
Metris S 31665000
Focus 31965000
Talis S / Talis 32675XXX

Talis S 72605000
Metris 31685000
Metropol 32565XXX
Metropol 74565000
Metropol Classic 31365XXX
Vernis Blend 71667XXX
Vernis Shape 71668XXX
Vivenis 75615XXX
Finoris 76615XXX

Novus 71065000 / 71065003
Novus Loop 71365000
Logis E 71603000
Rebris S 72667XXX
Rebris E 72668XXX

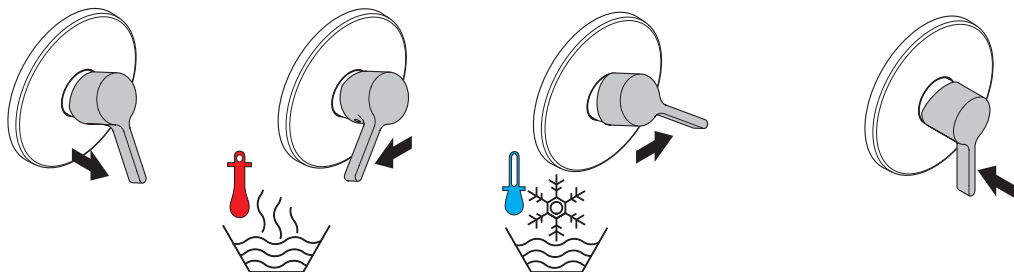
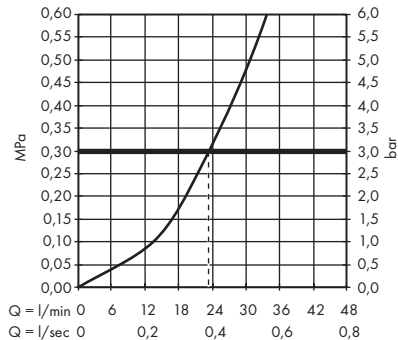
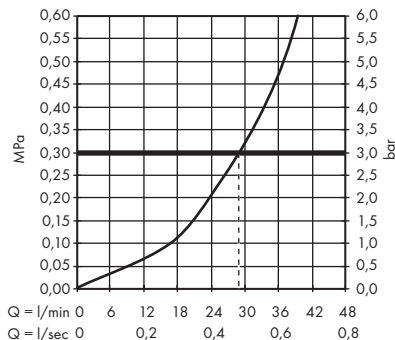



Talis Classic 14165000 / Metris S 31665000 / Focus 31965000 /

Talis S / Talis 32675XXX Talis S 72605000/ Metris 31685000 / Vernis Blend 71667XXX

XXX =Farbcodierung / Couleurs / Colors / Trattamento / Acabados / Kleuren / Overflade / Acabamentos /
Kody kolorów / Kód povrchové úpravy / Farebné označenie / 颜色代码 / Цветная кодировка / Värikoodaus /
Färgkodning / Spalvos / Boje / Renkler / Coduri de culori / Χρώματα / Barve / Värvid / Krásu kodi /
Oznake boja / Fargekode / Цветово кодиране / Kodimi me anë të ngjirave / الألوان / Színkódolás / 仕上げ色

000 =Chrome

250 =Brushed Gold-Optic

670 =Matt Black

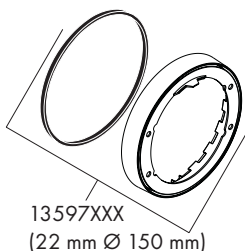
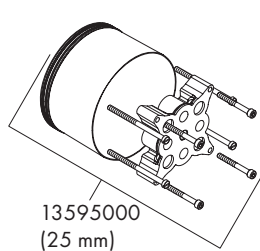
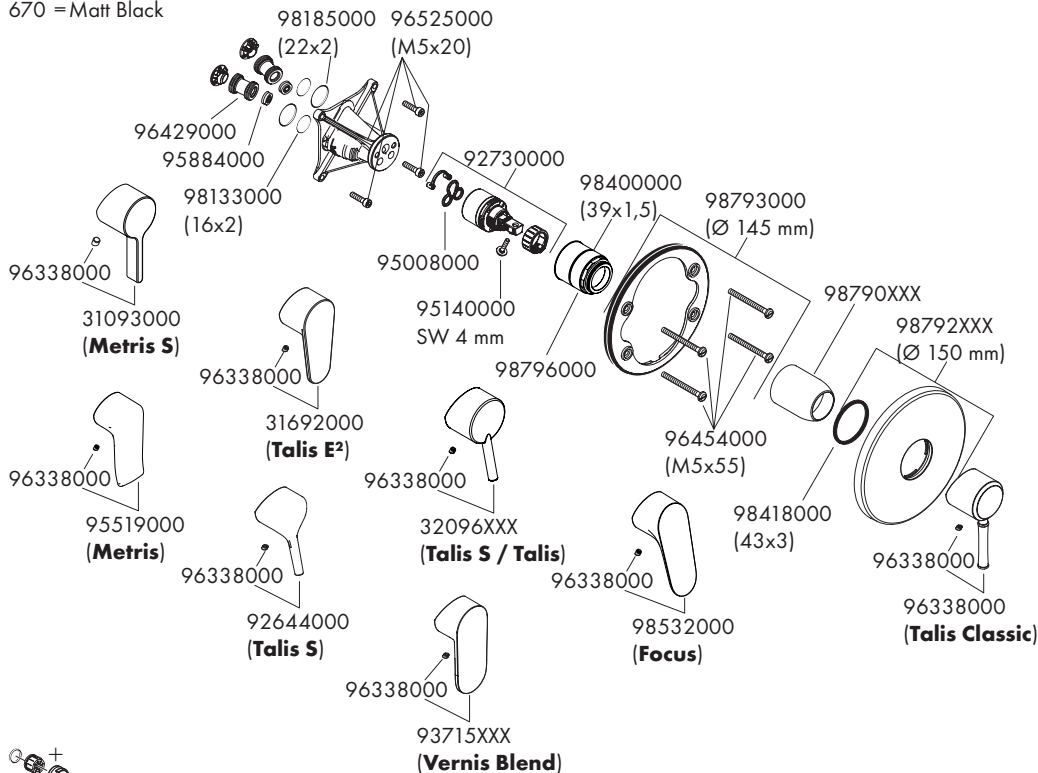



Metropol 32565XXX / Metropol 74565000

XXX =Farbcodierung / Couleurs / Colors / Trattamento / Acabados / Kleuren / Overflade / Acabamentos /
 Kody kolorów / Kód povrchové úpravy / Farebné označenie / 颜色代码 / Цветная кодировка / Värikoodaus /
 Färgkodning / Spalvos / Boje / Renkler / Coduri de culori / Χρώματα / Barve / Värvid / Krāsu kodi /
 Oznake boja / Fargekode / Цветово кодиране / Kodimi me anë të ngjyrave / الألوان / Színkódolás / 仕上げ色

- 000 = Chrome
- 140 = Brushed Bronze
- 340 = Brushed Black Chrome
- 670 = Matt Black
- 700 = Matt White
- 990 = Polished Gold-Optic

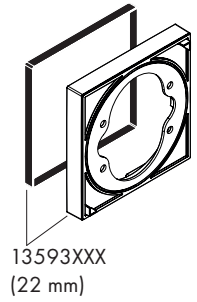
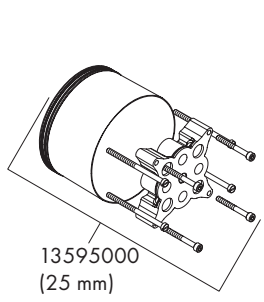
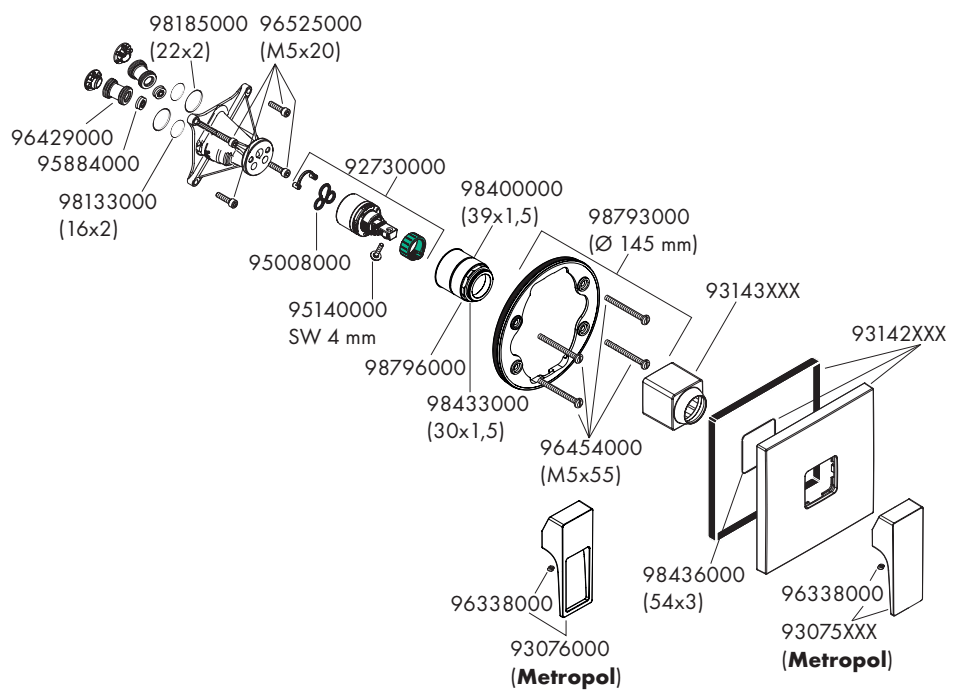



Metropol Classic 31365000

XXX =Farbcodierung / Couleurs / Colors / Trattamento / Acabados / Kleuren / Overflade / Acabamentos /
 Kody kolorów / Kód povrchové úpravy / Farebné označenie / 颜色代码 / Цветная кодировка / Värikoodaus /
 Färgkodning / Spalvos / Boje / Renkler / Coduri de culori / Χρώματα / Barve / Värvid / Krāsu kodi /
 Oznake boja / Fargekode / Цветово кодиране / Kodimi me anë të ngjyrave / الألوان / Színkódolás / 仕上げ色

000 =Chrome

090 =Chrome Plated/Gold Plated

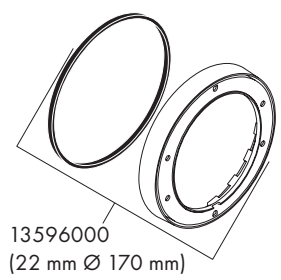
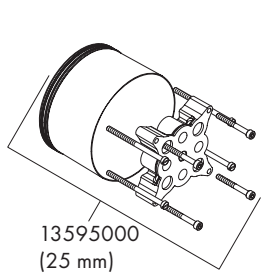
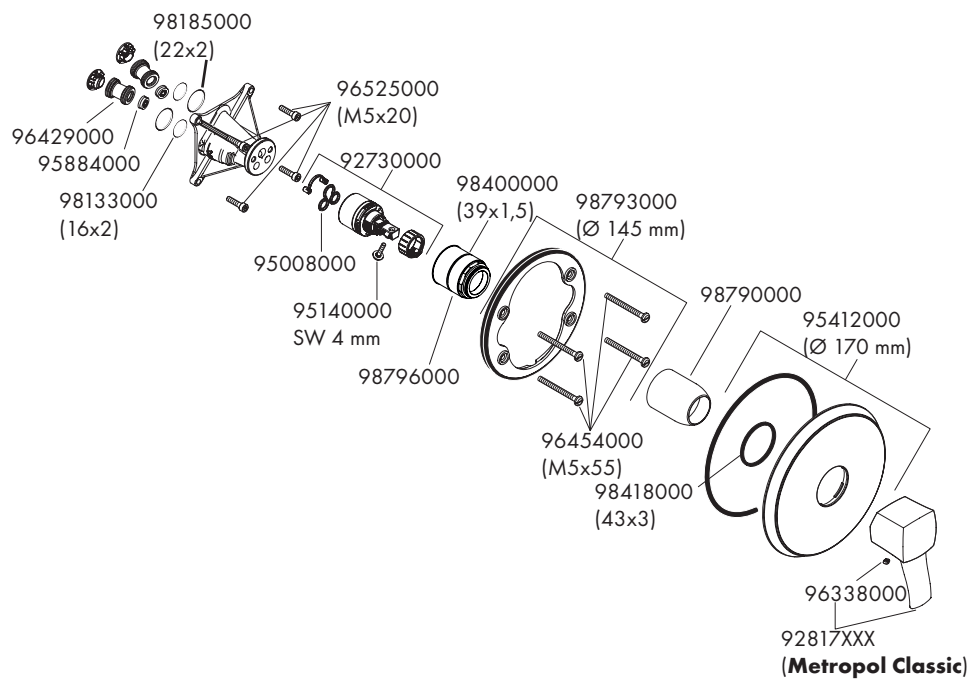



Vernis Shape 71668XXX / Vivenis 75615XXX / Finoris 76615XXX

XXX = Farbcodierung / Couleurs / Colors / Trattamento / Acabados / Kleuren / Overflade / Acabamentos /
 Kody kolorów / Kód povrchové úpravy / Farebné označenie / 颜色代码 / Цветная кодировка / Värikoodaus /
 Färgkodning / Spalvos / Boje / Renkler / Coduri de culori / Χρώματα / Barve / Värvid / Krāsū kodi /
 Oznake boja / Fargekode / Цветово кодиране / Kodimi me anë të ngjirave / الألوان / Színkódolás / 仕上げ色

000 = Chrome

670 = Matt Black

700 = Matt White

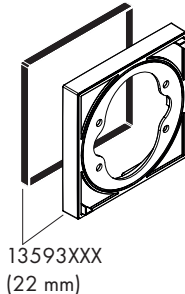
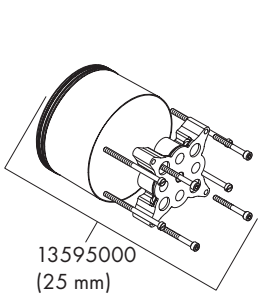
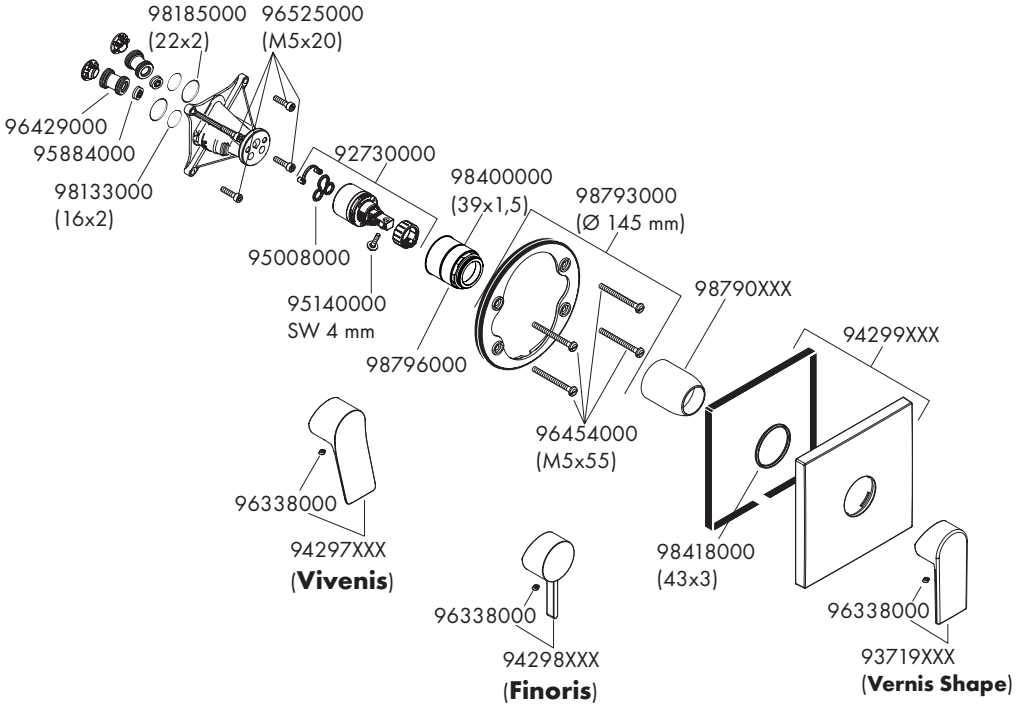



Novus 71065000 / 71065003 / Novus Loop 71365000 / Logis E 71603000 / Rebris S 72667XXX / Rebris E 72668XXX

XXX = Farbcodierung / Couleurs / Colors / Trattamento / Acabados / Kleuren / Overflade / Acabamentos / Kody kolorów / Kód povrchové úpravy / Farebné označenie / 颜色代码 / Цветная кодировка / Värikoodaus / Färgkodning / Spalvos / Boje / Renkler / Coduri de culori / Χρώματα / Barve / Värvid / Krāsu kodi / Oznake boja / Fargekode / Цветово кодиране / Kodimi me anë të ngjirave / الألوان / Színkódolás / 仕上げ色

000 = Chrome

670 = Matt Black

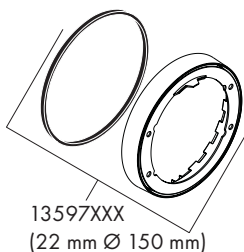
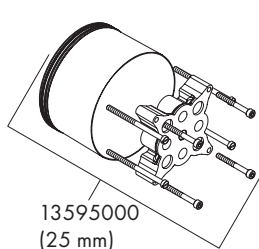
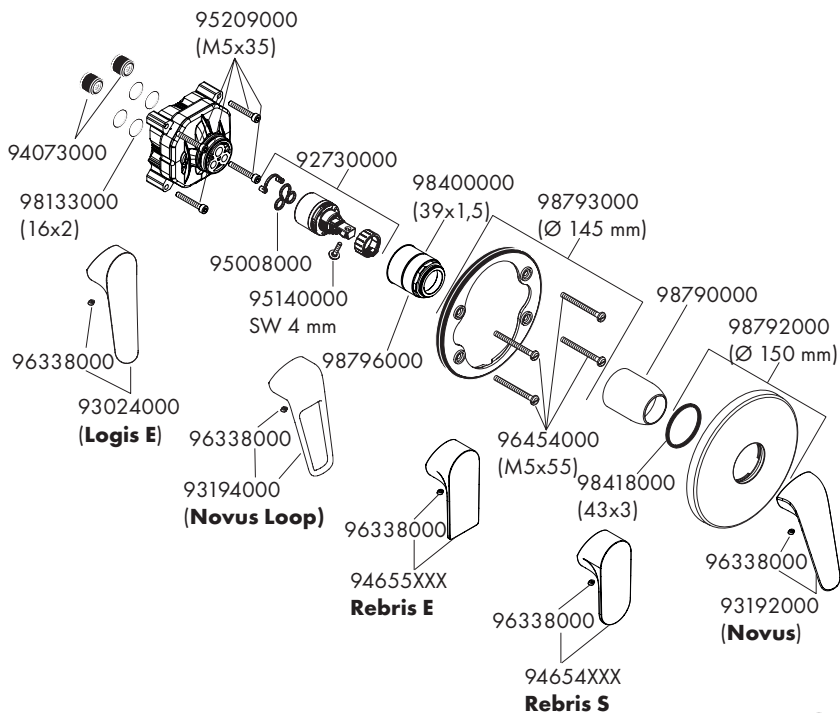



P-IX DVGW SINTEF NF STF CERTIFICATION BODY S E 44 ETA

14165000					X	X
15665XXX	PA-IX 9710/IB	CQ0125			X	X
31365XXX	PA-IX 9710/IB	CQ0125			X	X
31456000	PA-IX 9710/IB	CQ0125			X	X
31665000	PA-IX 9710/IB	CQ0125			X	X
31685000	PA-IX 9710/IB	CQ0125			X	X
31965000	PA-IX 9710/IB	CQ0125	X		X	X
32565XXX	PA-IX 9710/IB	CQ0125			X	X
32675XXX	PA-IX 9710/IB	CQ0125			X	X
71065000		CQ0125			X	
71267000	PA-IX 9710/IB	CQ0125			X	X
71365000		CQ0125			X	
71603000		CQ0125				
71605000	PA-IX 9710/IB	CQ0125	X		X	X
71667XXX	PA-IX 9710/IB					
71668XXX	PA-IX 9710/IB					
71765XXX	PA-IX 9710/IB	CQ0125			X	X
72605000	PA-IX 9710/IB	CQ0125			X	X
72667XXX	PA-IX 38261/IA	DN0343				
72668XXX	PA-IX 38261/IA	DN0343				
74565000	PA-IX 9710/IB	CQ0125			X	X
75615XXX	PA-IX 9710/IB	DM0707				
76615XXX	PA-IX 9710/IB					

Hansgrohe SE

DIN 4109-1

PA-IX 9710/IB



Hansgrohe SE

DIN 4109-1

PA-IX 38261/IA

