

User Manual

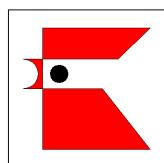

**Infrared-Rotisserie
RT-Series**



ubert®

1 Contents

1	Contents	3
2	Important References	4
2.1	Basic safety instructions.....	4
2.2	Warranty and Liability.....	5
2.3	Explanation of Symbols and notes for the user.....	5
2.4	Right of origin (Copyright)	5
2.5	Special safety notes for the user.....	6
3	Product information	8
3.1	Introduction	8
3.2	Special Features	8
3.3	Technical Data	9
4	Initial Installation Procedure.....	14
4.1	Unpacking	14
4.2	Installation	14
4.3	Installation	15
4.4	Preparation for operation	16
4.5	Re-adjustment.....	17
5	Operation.....	18
5.1	Operation elements.....	18
5.2	Use of the spits	19
6	Maintenance	22
6.1	Cleaning and care	22
6.2	Wiring Diagram	24
6.3	Spare parts.....	25
6.4	Declaration of Conformity.....	27

2 Important References

2.1 Basic safety instructions

2.1.1 Please read advices in the operation manual carefully

- It is important to have knowledge of the basic safety instructions and of your local safety regulations.
- This operation manual contains the most important advices to operate the appliance in the right safe way.
- We suggest that all operating personnel will follow both, this manual and especially these safety advices carefully.
- Please follow also the safety instructions issued by your local authorities.

2.1.2 Obligation of the owner/user

The owner/user declares, that he only allows the following personnel to operate the Wall of Flame Rotisserie:

- People being trained to operate this appliance and do know the regulations about basic safety instructions and how to prevent possible accidents.
- People who know about the safety chapter and the warnings within this operation manual. They have to confirm by signing.

These obligations are subject to be checked on a regular basis.

2.1.3 Obligation of the operating personnel

Personnel, being requested to operate this appliance, hereby confirm the following:

- That they know about the basic safety instructions and do know the regulations how to prevent possible accidents.
- That they have read the safety chapter and warnings in this operation manual and they have confirmed with their signature having understood all information.

2.1.4 How to use the Rotisseries. Possible risks.

Wall of Flame Rotisseries are built following the latest standard of technic and according to all safety regulations. However while operating in case of not following all safety instructions, they may cause severe risks for the operators and other people's life. They may also cause possible damages to the appliance. Therefore the appliance is only for the use of:

- Operation according to the designed purpose of a rotisserie.
- Being in optimal safe and technical conditions.

All malfunctions, which may affect the safety of the appliance, must be repaired immediately.

2.1.5 Operation according to the designed purpose

All Wall of Flame Rotisseries are built for the preparation of food only. Any other use of the unit is only allowed after consulting UBERT GASTROTECHNIK GMBH. Damages which result out of wrong use UBERT GASTROTECHNIK GMBH cannot be held responsible. Part of the due use is also:

- the consideration of all references of the operating manual and
- the observance of necessary maintenance and service.

2.2 Warranty and Liability

All products from the manufacturer are manufactured to the high nowadays technical standards and comply with all valid regulations. The manufacturer will grant a warranty to compensate all recognized valid claims. All other Warranty and Liability claims for people and appliances are excluded, especially if a possible damage is caused:

- In case of any improper use not according to the designed purpose.
- In case of wrong installation, incorrect setting into operation, wrong treatment and maintenance of the appliance.
- In case of operating the appliance with faulty, missing or not working safety features.
- By disregarding of the operation manual advices especially in the view of transport, storage, installation, setting into operation, operation and maintenance.
- By changing the appliance without any written permission.
- By changing the power dates without any written permission.
- In the case of non regular maintenance of any parts being subject to wear and tear.
- In case of nonprofessional service.
- In case of any force majeure.

2.3 Explanation of Symbols and notes for the user

Within this operation manual you will find the following signs and symbols:



This symbol stands for a possible danger for life and health. It also points out to a possible hazardous situation.

To disregard this symbol may cause severe hazardous effects up to severe injuries. It may also cause severe damages to your appliance!



This symbol will give important notes to the user how to treat the appliance in the right way.

To disregard this symbols may cause a possible damage to your appliance or to the environment!



This symbol will give you useful tips and advices.

They will help you in using all functions of the appliance in the best way!

2.4 Right of origin (Copyright)

The copyright on this operation manual remains strictly with the manufacturer. It is only issued for the owner and his trained personnel. This manual contains regulations and advices which either in parts or the full brochure may not be:

- duplicated
- circulated or
- used or announced for a different purpose.

Violation may cause criminal prosecution.



2.5 Special safety notes for the user

2.5.1 Safety devices

- Before setting the appliance into operation all safety devices and all removable parts have to be fitted and must operate in working order.
- Safety devices may only be removed after switching off the appliance completely. You must make sure, that the appliance cannot be switched on again during maintenance processes.
- All parts and components have to be fitted according to the regulations.

2.5.2 Special safety-notices

- The unit has to be operated only in well ventilated rooms.
- The unit corresponds to type B; this means, that all exhaust gas has to be carried off immediately. For sufficient ventilation of the room and proper carrying off of the exhaust gas pay attention to DVGW-worksheet G 634.
- The unit is intended for commercial use and has to be operated by qualified personnel only.

2.5.3 For your information (Informing safety steps)

- These operating instructions should be kept always together with the appliance.
- Supplementing to the operation instructions within this manual all local regulations for accident prevention and for the protection of the environment are to be considered.
- All stickers for safety and possible hazards on the appliance have to be in a good readable condition and in a visible position.

2.5.4 Personnel training

- Only trained and instructed personnel is allowed to operate the appliance.
- The responsibilities of the personnel are to be determined clearly for installing, start-up, operation, assembling, and servicing of the unit.
- Personnel not being trained yet are only allowed to operate the unit under supervision of a trained and experienced person.

2.5.5 Operating the controls

- Only trained personnel is allowed to operate the controls.

2.5.6 Safety check during operation

- Only operate the appliance if all safety devices are working properly.
- Before switching on, make sure that there is no danger for any person while the appliance is starting to operate.
- Check appliance at least once per day with regard to visible damages and to the function of all safety devices.

2.5.7 Possible hazards caused by electric energy

- Repair works on electrical leads and devices must be carried out by qualified electricians only.
- The connection must follow the rules of the local determinations.
- Check the electrical components of the appliance on a regular basis. Wiring being connected improper or melted cables have to be repaired immediately.
- If there is a need of repair works on life electrical components, always a second person is required to attend and to switch off the main switch in case of emergency.

2.5.8 Special areas of danger

- Spits are getting hot during regular operation. Use heat protective gloves or spit-lifts to handle the spits!
- Hood, inner walls and optional glasses are hot during regular operation!
- Drain all liquids before removing the drawer!

2.5.9 Maintenance, Trouble Shooting

- All prescribed adjustment-, maintenance- and serviceworks must be carried out by an authorized service technician on a regular basis.
- Before starting these maintenance- and service works the personnel must be clearly informed.
- Pull out the plug before maintaining, inspecting and repairing is performed.
- Make sure that all loose screw connections are fixed and secured again.
- Check all safety devices and their proper function carefully at the end of all maintenance-, service and repair works.

2.5.10 Technical amendments to the appliance

- No amendments, changings or reconstructions to the appliance are allowed to be carried out without the written permission of the manufacturer. Never weld on load-bearing parts of construction.
- All reconstructions do require a written permission of the manufacturer.
- Improper parts have to be changed immediately.
- Only use original spare parts.
- If you use spare parts of a third party, we cannot take over responsibility of their safe construction and of any proper use in our appliances. All possible damages caused by the use of improper parts will not be covered by the manufacturer.
- In case of reconstructions which impair the supply of air for combustion, the function of the unit has to be examined again.

2.5.11 Cleaning and waste disposal

All matters and materials should be used only in accordance with their purpose. Used materials, especially those for lubricating and cleaning must be disposed in accordance with the valid regulations. Only use detergents which are in accordance with the food hygienic regulations, environmental regulations and the regulations issued by your local authorities.

3 Product information

3.1 Introduction

The units are specially designed for operation in mobile sales vehicles. The Infrared-Rotisserie is suitable for Rotisserie-Shops, tents and the like. With a capacity between 2-15 spits depending on the model, the Infrared-Rotisserie fits to the highest demands. Available with one or two rows of spits, it saves energy cost. Suitable for all kinds of operation where high turn over should be generated within a small space available and where a reliable, large capacity is required. Built with a compact design, the Infrared-Rotisserie allows a capacity of up to 90 chicken or equivalent food products within 2 m². A user-friendly and flexible operation is maintained.

3.2 Special Features

- Completely made of stainless steel.
- Separately regulatable high duty infrared-burners in the back wall.
- Burners are removable without tools.
- Separat reflector sheets between the burners.
- high-performance gearbox-motor
- Inserted grease collector with large disposal to the bottom.
- Inserted deposit.
- Set-on extraction hood completely made of stainless steel with round connector.
- Spits with welden long-fork and clamp.
- available with glas-doors, lighting and grilling-baskets.

3.3 Technical Data

3.3.1 Dimensions [mm]

Shown example: RT44G

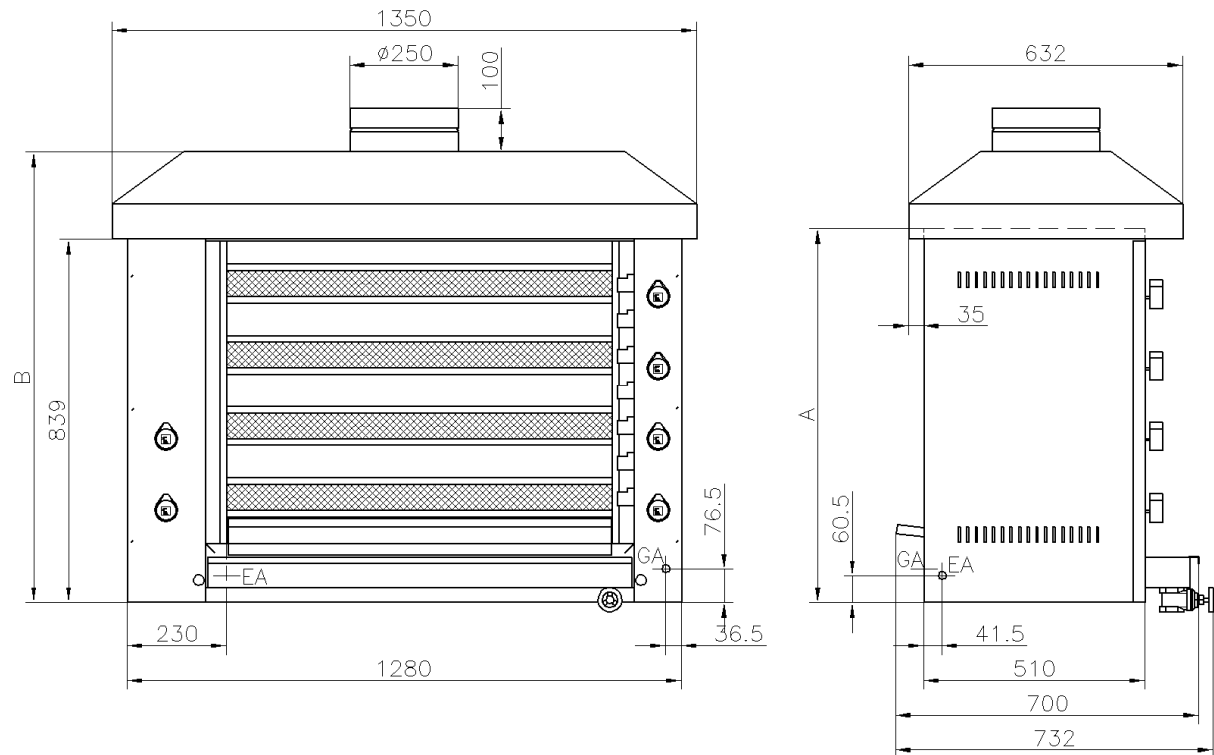

Model	Spits	Width	Depth	Height without Hood (A)	Height with Hood (B)	Hight of connector
RT2G	2	1280mm	700mm	535mm	711mm	100mm
RT22G	3	1280mm	700mm	535mm	711mm	100mm
RT3G	3	1280mm	700mm	700mm	876mm	100mm
RT33G	5	1280mm	700mm	700mm	876mm	100mm
RT4G	4	1280mm	700mm	865mm	1041mm	100mm
RT44G	7	1280mm	700mm	865mm	1041mm	100mm
RT5G	5	1280mm	700mm	1030mm	1206mm	100mm
RT55G	9	1280mm	700mm	1030mm	1206mm	100mm
RT6G	6	1280mm	700mm	1195mm	1371mm	100mm
RT66G	11	1280mm	700mm	1195mm	1371mm	100mm
RT7G	7	1280mm	700mm	1360mm	1536mm	100mm
RT77G	13	1280mm	700mm	1360mm	1536mm	100mm
RT8G	8	1280mm	700mm	1525mm	1701mm	100mm
RT88G	15	1280mm	700mm	1525mm	1701mm	100mm

3.3.2 Electrical Details, Power Consumption

Model	gassconnection	nominal gas power	el Connection
RT2G	R ¾"	10kW	230V, 1/N, 50Hz, 0.03kW
RT22G	R ¾"	10kW	230V, 1/N, 50Hz, 0.03kW
RT3G	R ¾"	15kW	230V, 1/N, 50Hz, 0.03kW
RT33G	R ¾"	15kW	230V, 1/N, 50Hz, 0.03kW
RT4G	R ¾"	20kW	230V, 1/N, 50Hz, 0.03kW
RT44G	R ¾"	20kW	230V, 1/N, 50Hz, 0.03kW
RT5G	R ¾"	25kW	230V, 1/N, 50Hz, 0.03kW
RT55G	R ¾"	25kW	230V, 1/N, 50Hz, 0.03kW
RT6G	R ¾"	30kW	230V, 1/N, 50Hz, 0.03kW
RT66G	R ¾"	30kW	230V, 1/N, 50Hz, 0.03kW
RT7G	R ¾"	35kW	230V, 1/N, 50Hz, 0.03kW
RT77G	R ¾"	35kW	230V, 1/N, 50Hz, 0.03kW
RT8G	R ¾"	40kW	230V, 1/N, 50Hz, 0.03kW
RT88G	R ¾"	40kW	230V, 1/N, 50Hz, 0.03kW

3.3.3 Weight [kg]

Model	Net weight
RT2G	app. 100
RT22G	app. 102
RT3G	app. 117
RT33G	app. 120
RT4G	app. 134
RT44G	app. 138
RT5G	app. 151
RT55G	app. 156
RT6G	app. 168
RT66G	app. 174
RT7G	app. 185
RT77G	app. 192
RT8G	app. 202
RT88G	app. 210

3.3.4 Noise Emission

Type	noise emission
all models	< 70 dB (A)

3.3.5 Nozzle table

Model	nominal gas power [kW]	minimum gas power [kW]	Gas type	No. of nozzles	Size of main nozzles [mmx100]	Size of min. nozzles [mmx100].	Opening of primary air [mm]
RT2/22G	10	7,17	Propane	2	95	95	fixed \triangle 2,5
RT2/22G	10	7,17	Natural H	2	165	open	fixed \triangle 2,5
RT2/22G	10	7,17	Natural L	2	190	open	fixed \triangle 2,5
RT3/33G	15	10,79	Propane	3	95	95	fixed \triangle 2,5
RT3/33G	15	10,79	Natural H	3	165	open	fixed \triangle 2,5
RT3/33G	15	10,79	Natural L	3	190	open	fixed \triangle 2,5
RT4/44G	20	14,3	Propane	4	95	95	fixed \triangle 2,5
RT4/44G	20	14,3	Natural H	4	165	open	fixed \triangle 2,5
RT4/44G	20	14,3	Natural L	4	190	open	fixed \triangle 2,5
RT5/55G	25	17,9	Propane	5	95	95	fixed \triangle 2,5
RT5/55G	25	17,9	Natural H	5	165	open	fixed \triangle 2,5
RT5/55G	25	17,9	Natural L	5	190	open	fixed \triangle 2,5
RT6/66G	30	21,5	Propane	6	95	95	fixed \triangle 2,5
RT6/66G	30	21,5	Natural H	6	165	open	fixed \triangle 2,5
RT6/66G	30	21,5	Natural L	6	190	open	fixed \triangle 2,5
RT7/77G	35	25,1	Propane	7	95	95	fixed \triangle 2,5
RT7/77G	35	25,1	Natural H	7	165	open	fixed \triangle 2,5
RT7/77G	35	25,1	Natural L	7	190	open	fixed \triangle 2,5
RT8/88G	40	28,67	Propane	8	95	95	fixed \triangle 2,5
RT8/88G	40	28,67	Natural H	8	165	open	fixed \triangle 2,5
RT8/88G	40	28,67	Natural L	8	190	open	fixed \triangle 2,5

3.3.6 Indication of consumption

Model	Gastype	Consumption of Propane on H _{UB} =12,87 ^{kW} /kg [m ³ /h]	Consumption of Natural H on H _{UB} =9,45 ^{kW} /kg [m ³ /h]	Consumption of Natural L on H _{UB} =8,13 ^{kW} /kg [m ³ /h]
RT2/22G	Propane	0,78	--	--
RT2/22G	Natural H	--	1,06	--
RT2/22G	Natural L	--	--	1,23
RT3/33G	Propane	1,17	--	--
RT3/33G	Natural H	--	1,59	--
RT3/33G	Natural L	--	--	1,85
RT4/44G	Propane	1,56	--	--
RT4/44G	Natural H	--	2,12	--
RT4/44G	Natural L	--	--	2,46
RT5/55G	Propane	1,94	--	--
RT5/55G	Natural H	--	2,65	--
RT5/55G	Natural L	--	--	3,08
RT6/66G	Propane	2,33	--	--
RT6/66G	Natural H	--	3,17	--
RT6/66G	Natural L	--	--	3,69
RT7/77G	Propane	2,72	--	--
RT7/77G	Natural H	--	3,70	--
RT7/77G	Natural L	--	--	4,31
RT8/88G	Propane	3,11	--	--
RT8/88G	Natural H	--	4,23	--
RT8/88G	Natural L	--	--	4,92

4 Initial Installation Procedure

Our Infrared Rotisseries are packed for safe transport, so that they can reach their destination without any damages. However we advise an examination of Infrared Rotisseries right after delivery.



Attention! Do report visible damages immediately!

4.1 Unpacking

- Open the box and take out the wrapping and filling material carefully.
- Take out all single parts and check whether these are complete (compare with enclosed dispatch documents).
- Now please remove the cardboard packaging and all wrapping and covering folios from the rotisserie.

4.2 Installation

Install the unit and set it up at the desired place. Make sure that the unit is visible to your customers to create a demand for your food offer and increase your sales.

During installation please note the following:

- Install the feet of the unit and set it up at the place as wanted.
- Set up the unit on an even, horizontal surface! Line up the unit horizontal.
- Observe that all slots for air supply and ventilation are held free and are at least 100 mm away from walls or similar things which could block the slots.
- Take care that the area around the rotisserie is free in order to load, unload, clean the unit or that maintenance works can be done smoothly.
- The unit has to be set up in a way that the surrounding area can be cleaned.



4.2.1 Place of operation

Important! The rotisserie has to be set up on an even, stable and fireproof surface in a good ventilated room and below an existing ventilation hood. Depending on the model the unit can be placed free in a room or at a temperature-resistant wall or in one line with other equipment. A minimum distance of 200 mm from walls made of inflammable material has to be observed. If these distances fall below corresponding heat protection measures have to be made, for instance tiling of walls or application of a radiation protection. Before you install the unit check the type plate, whether the unit is approved for the the local existing kind of gas. If the kind of gas indicated on the type plate does not agree with the required kind of gas, the installation of the rotisserie is not allowed until the unit has been adjusted according to the requirements.



Note! When installed in a sales vehicle, make sure that the provided converter creates a sinusoidal rotating field.



Note! It is not allowed to set up a workplace in the area of radiation heating as it is too hot there.



4.3 Installation

Before the unit can be installed it is necessary to have the comments / approval of the responsible gas supply company.

Only a installation company which is approved by the responsible gas supply company is allowed to set up the unit, install the gas connection and to start the operation. The laws, technical regulations and directions mentioned under section 4.2.3 have to be observed. Only approved companies are allowed to do maintenance work or gas adjustments and they have to observe this manual and corresponding regulations.



4.3.1 Statutory orders, technical regulations and directives

The following regulations have to be observed when the unit is set up:

- local statutory orders
- local laws valid for your countries
- technical regulations for fluid gas
- directions of the local gas supply company



Furthermore regulations of accident prevention valid for your country have to be observed.

For operating the unit outside Germany the national laws, technical regulations and directions of the specific country are valid.

4.3.2 Gas connection

Check whether the gas unit is adjusted for the existing kind of gas. Compare the indicated kind of gas on the type plate with the existing kind of gas. If this is not the case an adjustment according to the local requirements is necessary. The gas connection depends on the rotisserie model (external thread right acc. to DIN-ISO 7/1 [DIN 2999, part 1] 1 inch). The connection with the gas supply has to be made through the intermediary of a connection armature and through a thermically secured shutoff device. Technical regulations have to be observed. Only an approved technician is allowed to do this work. After the gas connection has been made all points of connection have to be tested for leaks under operation pressure by leak detecting spray or by brushing with foam forming mediums which do not cause corrosion.



4.3.3 Electrical connection

Note! Note that also after installation and electrical connection the plug must be accessible. If this is not possible due to structural reasons, or if the unit is connected permanently, the power supply needs to have an interlock switch.



Note! During any servicing, take care that the unit is disconnected from the mains! Not paying attention may result in injury!



Please learn the electrical and technical data of your unit from the nameplate.

- The unit is ready for plug-in.
- For power supply a shockproof socket is necessary.
- Make sure the supply cable is protected separately with 16 Amps.

The existing connection cable for the electrical connection is positioned at the lower

right rear wall.

Note!

After finishing any installation work, maintenance or repair, check whether the ground wires are connected properly to the casing.



4.4 Preparation for operation

Before you can operate the Infrared Rotisserie you have to clean the unit and all removable parts (eg. spits etc.) carefully with a grease solvent detergent. Afterwards you have to dry all surfaces.

Note! Do not use flammable cleaners. Do not use high pressure-, water pressure- or steam jet- cleaning machines. You will have further information about this in the section "cleaning and maintenance".



After cleaning the Infrared Rotisserie properly the smell will be minimal when using it the first time.

4.4.1 Betriebsbereitstellung

The units have to be checked on their designed nominal heat load and adjusted accordingly if required when they are installed the first time or after any maintenance work. Please learn the necessary data from the corresponding table.

4.4.2 Control of nominal heat load

Firstly, please check whether the unit is adjusted for the existing kind of gas. For this you have to check whether the indication on the type plate corresponds to the existing kind of gas. If you adjust the unit for other gas types please check the indication of the nozzles. The nominal heat load results from using the right nozzle with connection pressure of

+ 20 mbar with natural gas H and natural gas L (for France E+)

+ 50 mbar with fluid gas

by taking effect of the corresponding tuyère area.

The permission of operation with the resulting nominal heat load under dependency of the planned nozzles results from the following connection pressure bounds:

15 to 25 mbar with natural gases)

25 to 35 mbar and 42.5 to 57.5 mbar with fluid gas

Starting the operation outside these pressure bounds is not permitted.

The connection pressure is measured by a pressure gauge (indication exactness: 0.1 mbar). For this the sealing screw in the connection pressure measuring socket of the main gas supply has to be loosened and the pressure gauge has to be connected.

4.4.3 Checking of nominal heat load with liquid propane gas

Check whether the indication of used nozzles corresponds to the indications of the manufacturer. Secure that the existing low pressure regulator on site does not exceed a maximum output pressure of 50 mbar according to section 4.4.2 (control of type plate or pressure measurement).

4.4.4 Funktionskontrolle

- Set the unit into operation according to the manual.
- Check the unit for gas leaks.
- Check the correct adjustment of primary air and nozzles (main nozzles (at the burner nozzle assembly)).

4.5 Re-adjustment

Attention! Before any re-adjustment works at the unit are executed the main gas supply has to be closed and the unit has to be unplugged firstly.



All units of our production are single examined and are adjusted for the kind of gas required by the customer. If no indication has been made, the units are principally adjusted for fluid gas. If the unit is to be re-adjusted it has to be observed that this is made by an approved technician or by the Ubert service technicians. The corresponding nozzles sizes are to be find in the nozzle table. For re-adjustment the following measures have to be made:

- Replacement of main nozzles.
- Replacement of bypass nozzle
- Adjustment of primary air.
- Checking of function and indication of new gas type on the type plate at the front of the unit.

4.5.1 Replacement of main nozzle

- Close the main gas supply and unplug the unit.
- Remove reflector sheet to get access to the tie rod at the back of the burner.
- Unlock tie rod.
- Remove burner.
- Unscrew the main nozzle and exchange it corresponding to the nozzle table.
- The reassembling has to be made in reversed sequence. Afterwards, check the function.

4.5.2 Replacement of bypass- / minimum adjustment nozzle

- Close the main gas supply and unplug the unit.
- Pull the knob to remove it.
- Loosen the screws at the front panel and remove the front panel.
- The minimum adjustment nozzle is located above the valve. Adjust the minimum nozzle corresponding to the nozzle table.
- The reassembling has to be made in reversed sequence. Afterwards, check the function.

4.5.3 Adjustment of minimum position

For liquid propane gas and natural gas please learn the size of minimum adjustment nozzle from the nozzle table. For liquid propane gas the corresponding nozzles have to be turned against the stop. For natural gas the nozzle has to be unscrewed 1-2 thread revolutions

5 Operation

Following you find explanations regarding all important position and function components for the operation of the unit:

5.1 Operation elements

All operation elements are located at the front panel.

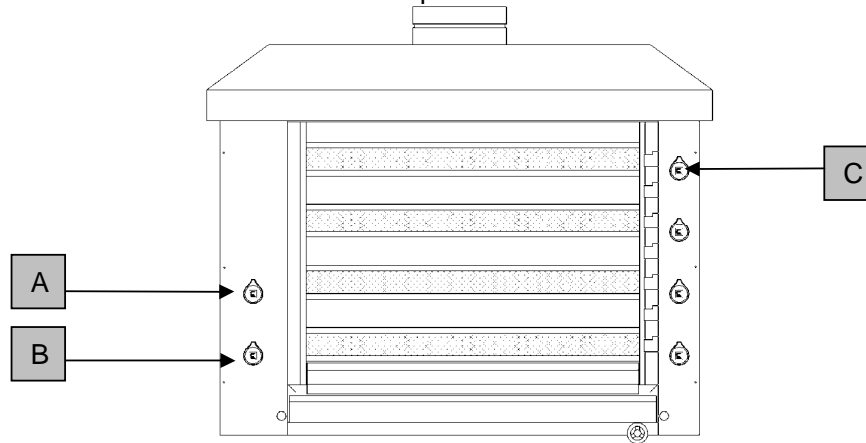

5.1.1 Commissioning

Please note the following checklist while commissioning your Infrared Rotisserie:

- Firing order is always from top to bottom.
- To ignite, quarter-turn the knob C to the left (Max. position).
- Then push the knob C to allow the gas to escape.
- Use a suitable lighter.(eg. Ubert special gas lighter P/N GAZ).
- After successful ignition, keep the knob pushed for 15-20 seconds.
- After releasing the knob, the burner is in maximum position.
- Turn the knob counterclockwise to change to minimum position.

5.1.2 Rotation of spits

Turn knob B to position I to start the gear motor. Turn knob B to position O to stop the gear motor.

5.1.3 Lighting (optional)

Turn knob A to position I to switch on lighting. Turn knob A to position O to switch off lighting.

5.1.4 Shut down

Turn knob C to position O to extinguish the burner.

5.1.5 For longer down times

For longer down times, all burners have to be extinguished and the main gas supply valve has to be locked.



5.2 Use of the spits

5.2.1 Use of double spits

Sofern die Hähnchenfüße nicht zusammen gebunden sind, binden Sie diese mit einer Schnur zusammen, damit sie sich während des Grillens nicht unkontrolliert hin und her bewegen. Stecken Sie das Hähnchen mit der Kopfseite voran auf den Grillspieß. Führen Sie den Vierkantstab des Spießes dabei durch das Loch an der Kopfseite in das Hähnchen und anschließend durch das Loch an den Füßen wieder heraus. Legen Sie die Flügel um die beiden Rundstäbe außen vorbei.



Schieben Sie das Hähnchen bis an das Ende des Spießes und stecken Sie die Flügel zwischen Rundstab und Hähnchen fest.



Stecken Sie die übrigen Hähnchen wieder mit der Kopfseite zuerst auf den Grillspieß und verfahren Sie weiter wie oben beschrieben. Stecken Sie die Flügelenden dann in das Loch am Fußende des vorherigen Hähnchens fest. Fixieren Sie die Hähnchenreihe mit der Endklammer, indem Sie diese direkt hinter dem letzten Hähnchen befestigen, um ein Verrutschen der Hähnchen entlang des Spießes zu vermeiden.

5.2.2 Use of baskets

Legen Sie die Hähnchen auf das Unterteil des Grillkorbes. Stecken Sie das Oberteil des Grillkorbes auf das Unterteil und befestigen Sie dieses mit den Splinten.

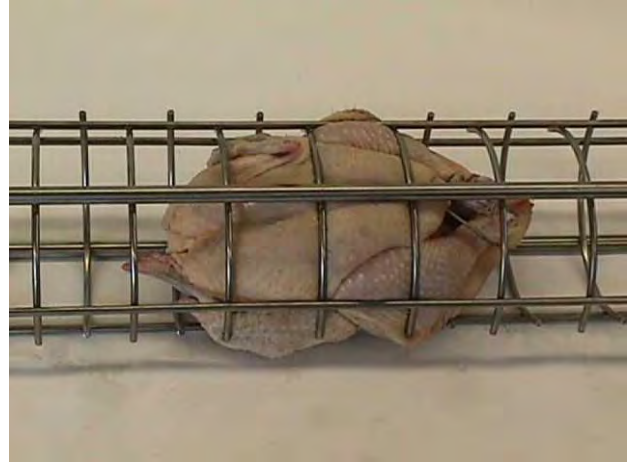

6 Maintenance

Following we give you advices for maintenance, possible trouble shooting and for service cases of your unit.

6.1 Cleaning and care

6.1.1 Safety advices

- Before you start any cleaning or maintenance work close the main gas supply and unplug the unit.
- Start the cleaning procedure only when the unit is cold.
- Never use flammable liquids, nor use any sharp or metallic utensils for cleaning your appliance. Do not use high pressure water or steam appliances! More detailed information to follow below.
- Wear acidproof gloves while cleaning the parts to prevent skin irritations.



6.1.2 General Recommendations

- The unit has to be cleaned daily.
- Only use non-poisonous cleaners (neutral or alkaline detergents) which are harmless in connection with food, even if there are plain and persistent residues.
- After cleaning with special cleaners you have to wash all parts with clear water and dry them afterwards so that there are no residues of the cleaner on these parts.
- It is absolutely necessary to watch out for some fundamental things to keep this longliving high-grade-steel-machine working:
 - always keep the high-grade-steel surface clean.
 - watch out that there is always enough fresh air on the surface
 - never contact the surface with rusty material
- Never use bleaching or chlorine cleaners.
- Observe that no residues or waste reaches the burner or thermo element during operation or cleaning, as this can cause damages to the proper function of the burner.



6.1.3 Special Recommendations

Control the grease lubrication of the bearings and the chain at least quarterly, if necessary more often. If the bearings and the chain are not greasy enough, grease them to ensure a reliable working of the bearing. For lubrication use heat-resistant grease only. Disregarding follows defect bearings and breakdown of the spit rotation! (Heat-resistant grease (P/N 412221) and grease guns (P/N 550408) are available at Ubert.)



6.1.4 Detergents

To make the cleaning fast and easy we have integrated some cleaners in our program:

- Stainless steel-cleaner
You have to spray this from a distance of app. 25 cm on the surface and wipe it off with a dry cleaning rag. If you want to clean only small parts you have to spray it di-



rectly on the cleaning rag and wipe it off this way. With this method it is possible to clean the Rotisserie Wall of Flame easily and without stripes..

6.1.5 Daily Cleaning

1. Make sure that the unit is cooled down bevor you start the cleaning procedure!
2. Unplug the unit.
3. Close the main gas supply.
4. Take out all removable Parts of the unit:
 - Open the glasdoors (optional).
 - Remove all remaining spits and/or baskets.
 - Empty the drip tray:
 - Put a suitable container below the discharge valve.
 - Open the discharge valve.
 - Discharge all liquid into the container and dispose it appropriate.
 - Remove the rest.
 - Remove the drip tray.
 - Remove the reflector sheets between the burners.
5. Clean all removable parts with a suitable detergent. Dry all parts.
6. Clean all parts of the rotisserie with a suitable detergent. Dry all parts.
7. Clean the gall doors (optional) with a soft cloth. Avoid scratching of the glas doors.



Make sure, that no water/grease residues reach the burners or temperatur probes.



6.2 Wiring Diagram

6.2.1 All Models

240V / 50-60Hz / 1/N

240V/50Hz

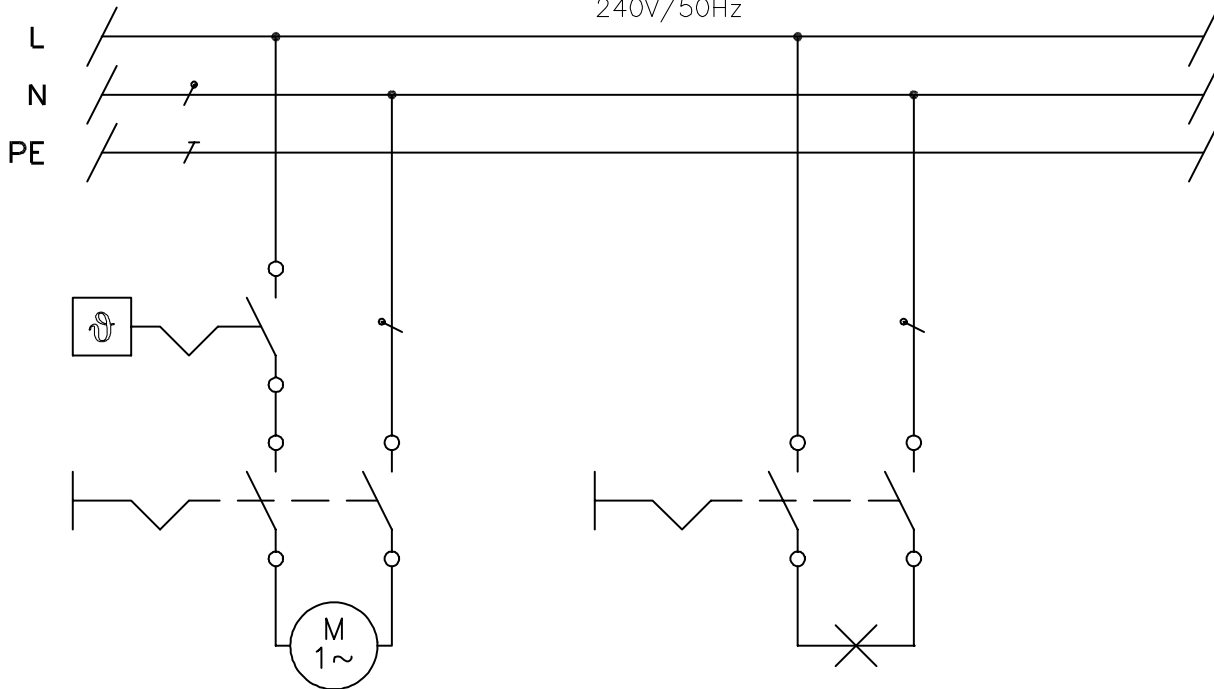











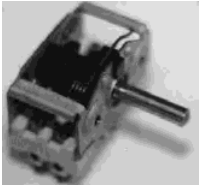
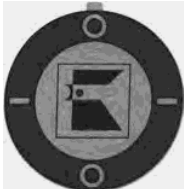
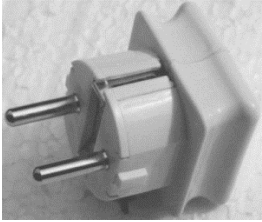

6.3 Spare parts

Replace defect or faulty parts only by using our original spare parts. Repairworks and changing of any parts must be carried out by authorized service personell. Disregarding these advices will cause a loss of any warranty claims. Also all certificates (such as: CE, UL, VDE, GS and others) will not be valid anymore!

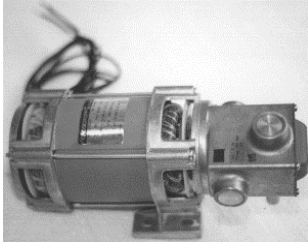

6.3.1 List of Spare Parts

<p>lamp socket 340412</p> 	<p>halogen lamp 200W 340620</p> 	<p>temperature probe 450mm 352333</p> 
<p>valve 351207</p> 	<p>knob 361310</p> 	<p>dial scale, gas 360215</p> 
<p>penstock with nozzle 352713</p> 	<p>nut for penstock 353215</p> 	<p>sprocket 18 teeth 380516</p> 
<p>sprocket 12 teeth 380509</p> 	<p>spit axis 380612</p> 	<p>chain 380505</p> 
<p>pedestal 380605</p> 	<p>sprocket assy 15 teeth. 380513</p> 	<p>chain lock 380507</p> 

<p>double nipple 355120</p> 	<p>switch 16A 341115</p> 	<p>dial scale I/O 360203</p> 
<p>shockproof plug 341301</p> 	<p>plug for motor, female 341401</p> 	<p>plug for motor, male 341302</p> 
<p>burner 190583</p> 	<p>ceramic inlay, large 350805</p> 	<p>ceramic inlay, small 350806</p> 
<p>wire mesh 190170</p> 	<p>ceramic fiber strip 190320</p> 	<p>gear motor 190698</p> 
<p>disposal valve 355303</p> 	<p>spit rest 380662</p> 	

6.4 Declaration of Conformity

UBERT GASTROTECHNIK GMBH
Gewerbegebiet Ost + Nord
D-46348 Raesfeld

Telefon: +49 (0) 28 65 / 602-0
Fax: +49 (0) 28 65 / 602-102
Internet: www.ubert.com
e-mail: info@ubert.com



CE KONFORMITÄTSERKLÄRUNG DECLARATION OF CONFORMITY CERTIFICAT DE CONFORMITÉ

Hereby we declare that the unit noted below, on the basis of its concept, design and version, meets all basic health and safety requirements of the applicable EC-directive. This declaration is no longer effective in case this machine has been modified without our approval.

Product designation:	Infrared Rotisserie
Model:	RT2/22G RT6/66G RT3/33G RT7/77G RT4/44G RT8/88G RT5/55G
CE-Number	CE-0085AP0133
EC-directives followed:	Directive for appliances burning gaseous fuels 90/396/EWG Modification directive for appliances burning gaseous fuels 93/68/EWG EC-directive for machines 2006/42/EG EC-directive for low voltage 2006/95/EG EC-directive for electromagnetic compatibility 2004/108/EG
Harmonized European Standards:	EN 203-1 Gas heated catering equipment - General safety rules EN 203-2 Gas heated catering equipment -- Specific requirements
Applied national standards and technical specifications:	BGR111 directions for safety and health protection regarding kitchen work VDE 0700 Safety of household and similar electrical appliances

This declaration does not include any assurance of characteristics.

The safety references enclosed with the product documentation have to be followed.

By internal actions it is guaranteed, that all serial units meet the demands of the corresponding EC directive and the applied standards.

The signers are entitled to compose the technical documents.

Raesfeld, 01.01.10
UBERT GASTROTECHNIK GMBH

Christoph Stephan
Vice President, R&D / Engineering

Raesfeld, 01.01.10
UBERT GASTROTECHNIK GMBH

Michael Peters
Service - Manager

Manufactured by: UBERT GASTROTECHNIK GMBH
Gewerbegebiet Ost + Nord
D-46348 Raesfeld