

DOUGH SHEETER

SF450 - SF500 - SF600



OPERATION AND MAINTENANCE MANUAL

TRANSLATION OF THE ORIGINAL INSTRUCTIONS

All rights reserved. Reproduction in whole or in part of this manual is prohibited.

FLAMIC SRL Via dell'Artigianato, 5 36035 MARANO VICENTINO (VICENZA) - Italy

Vat No. and Tax Code 03198710240 e-mail: info@flamic.it Web: www.flamic.it Tel. +39 0445 576659 Fax +39 0445 277203

Ed. 10/2016
Rev.02 10/2017

TABLE OF CONTENTS

EC DECLARATION OF CONFORMITY.....4

1 INTRODUCTION.....5

1.1 FOREWORD.....5

1.2 INSTRUCTIONS AND GENERAL PRECAUTIONS.....6

1.3 MAIN CIRCUMSTANCES IN WHICH THE COMPANY DISCLAIMS LIABILITY6

1.4 TERMINOLOGY7

1.5 VALIDITY OF THE CE MARKING AND EC DECLARATION OF CONFORMITY8

2 CHARACTERISTICS OF THE MACHINE.....9

2.1 DESCRIPTION AND INTENDED USE9

2.2 MACHINE MODELS AND VERSIONS11

2.3 CUTTING UNIT ST600 (OPTIONAL).....11

2.4 CONTROL DEVICES.....12

2.5 ROLLING THICKNESS ADJUSTMENT LEVER (HANDLE)13

2.6 MAIN TECHNICAL SPECIFICATIONS.....14

2.7 IDENTIFICATION PLATE16

3 INSTALLATION AND USE17

3.1 INSTRUCTIONS REGARDING THE PLACE OF INSTALLATION17

3.2 TRANSPORT, HANDLING AND POSITIONING17

3.3 ELECTRICAL CONNECTIONS19

3.4 INSTALLING/REMOVING THE TABLES OF A SHEETING MACHINE (MOD. SF600)20

3.4.1 INSTALLING A TABLE (MOD. SF600).....20

3.4.2 REMOVING A TABLE (MOD. SF600).....21

3.5 LIFTING AND LOWERING THE INTERLOCKED GUARDS22

3.5.1 MOD. SF450.....22

3.5.2 MOD. SF500 AND SF60022

3.6 PLACING THE BENCHES IN THE WORK POSITION OR RAISING THEM WHEN NOT IN USE23

3.6.1 MOD. SF450.....23

3.6.2 MOD. SF500.....24

3.6.3 MOD. SF600.....25

3.7 MOD. SF450B: POSITIONING AND FASTENING THE MACHINE ON THE TROLLEY (OPTIONAL)26

3.8 UNDER-TABLE AND CENTRAL DUST AND RESIDUE COLLECTION TRAY(S).....26

3.9 CATCH PANS FOR COLLECTING THE DOUGH SHEET THAT IS TOO LONG FOR THE CONVEYORS27

3.10 CUTTING UNIT (only for SF600V with bench lengths of 1400 mm or greater).....28

3.10.1 INSTALLING AND POSITIONING THE CUTTING UNIT28

3.10.2 DISABLING THE CUTTING UNIT29

3.10.3 ADJUSTING THE FORCE EXERTED ON THE BENCH BY THE CUTTING ROLLERS30

3.10.4 REMOVING / INSTALLING THE CUTTING ROLLERS30

3.10.5 REMOVING THE CUTTING UNIT.....31

3.11 OPERATION AND USE32

3.11.1 GENERAL INFORMATION FOR USE32

3.11.2 SWITCHING THE MACHINE ON AND OFF33

3.11.3 PREPARING THE MACHINE.....33

3.11.4 USING THE MACHINE AS A SHEETER33

3.11.5 USING THE MACHINE FOR PRODUCING DOUGH SHAPES FROM THE ROLLED SHEET.....33

3.12 PUTTING THE MACHINE TEMPORARILY OUT OF SERVICE AND STORING IT34

3.13 TRAINING OF PERSONNEL ASSIGNED TO THE MACHINE.....34

4 MAINTENANCE35

4.1 FOREWORD.....35

4.2 MAINTENANCE AND PERIODIC CHECKS35

4.3 DRIVE BELT TENSION ADJUSTMENT AND REPLACEMENT.....35

4.3.1 GENERAL RULES FOR CHECKING THE TENSION OF A DRIVE BELT35

4.3.2 SHEETER MOD. SF450.....36

4.3.3 SHEETER MOD. SF500 - SF600.....37

4.4 ADJUSTING THE TENSION AND CENTRING OF THE CONVEYOR BELTS.....38

4.5 REMOVING/INSTALLING THE SCRAPERS.....39

4.5.1 UPPER ROLLER SCRAPERS39

4.5.2 LOWER ROLLER SCRAPERS40

4.5.2.1 MOD. SF45040

4.5.2.2 MOD. SF50041

4.5.2.3 MOD. SF60042

4.6 REPLACING THE CONVEYOR BELTS43

4.6.1 SHEETER MOD. SF450 and sf50043

4.6.2 SHEETER MOD. SF600.....50

4.7 REPLACING A DRIVE CHAIN.....50

4.8 ELECTRICAL SYSTEM MAINTENANCE51

4.9 REPLACING THE MICRO SWITCHES OF THE INTERLOCKED GUARDS51

4.10 CLEANING.....52

4.11 POSSIBLE FAILURES AND / OR FAULTS53

4.12 SPARE PARTS.....53

4.13 PROLONGED STOP OR TAKING THE MACHINE OUT OF SERVICE.....53

All rights reserved. Reproduction in whole or in part of this manual is prohibited.

5	SAFETY.....	54
5.1	FOREWORD.....	54
5.2	HAZARDS, SAFETY DEVICES AND RESIDUAL RISKS	54
5.2.1	HAZARDS ASSOCIATED WITH THE MACHINE.....	54
5.2.2	MACHINE SAFETY DEVICES	55
5.2.3	CHECKING THE WORKING ORDER OF SAFETY EQUIPMENT	57
5.2.4	RESIDUAL RISKS	57
5.2.4.1	RESIDUAL RISKS OF A MECHANICAL NATURE.....	57
5.2.4.2	RESIDUAL RISKS DUE TO THE MACHINE TIPPING OVER.....	57
5.2.4.3	RESIDUAL RISKS ASSOCIATED WITH THE MACHINE STARTING UNEXPECTEDLY	58
5.2.4.4	RESIDUAL RISKS DUE TO INHALING DUST.....	58
5.2.4.5	RESIDUAL RISKS DUE TO POOR HYGIENE.....	58
5.2.4.6	RESIDUAL RISKS ASSOCIATED WITH ERGONOMICS.....	58
5.2.4.7	RESIDUAL RISKS OF AN ELECTRICAL ORIGIN.....	58
5.2.5	MACHINE NOISE LEVELS	59
5.3	SAFETY SIGNS.....	60
6	DISPOSAL	60

ATTACHMENTS: WIRING DIAGRAMS

INDEX TO FIGURES

Figure 1 - Main parts of the machine.....	10
Figure 2 - Support trolley for SF450B.....	11
Figure 3 - Cutting unit.....	11
Figure 4 - Control devices	12
Figure 5 - Rolling thickness adjustment.....	13
Figure 6 - Dimensions	15
Figure 7 - Identification plate and its position	16
Figure 8 - Handling the palletised machine using a forklift truck	17
Figure 9 - Lifting slings for model SF450.....	18
Figure 10 - Wheel brake levers	18
Figure 11 - Power cable plug	19
Figure 12 - Installing the benches (mod. SF600)	20
Figure 13 - Removing the benches (SF600 only).....	21
Figure 14 - Raising/lowering the interlocked guards (mod. SF450).....	22
Figure 15 - Raising/lowering the interlocked guards (mod. SF500 - SF600).....	22
Figure 16 - Raising/lowering the benches (mod. SF450)	23
Figure 17 - Raising/lowering the benches (mod. SF500)	24
Figure 18 - Raising/lowering the benches (mod. SF600)	25
Figure 19 - Fastening the sheeting machine mod. SF450 to the carriage (optional)	26
Figure 20 - Under-table and central (only SF500 and SF600) residue collection trays	26
Figure 21 - Catch pan.....	27
Figure 22 - Installing the cutting unit	28
Figure 23 - Disabling the cutting unit.....	29
Figure 24 - Adjusting the force exerted on the bench by the cutting rollers.....	30
Figure 25 - Removing/installing the cutting rollers.....	30
Figure 26 - Removing the cutting unit	31
Figure 27 - Rolling pin and relative supports.....	33
Figure 28 - Machine with benches raised.....	34
Figure 29 - Diagram showing the parameters used for tensioning a drive belt.....	35
Figure 30 - Mod. SF450: adjusting the tension of the drive belt	36
Figure 31 - Mod. SF500 and SF600: adjusting the tension of the drive belt(s).....	37
Figure 32 - Conveyor belt tensioning and centring system.....	38
Figure 33 - Removing/installing the upper roller scrapers	39
Figure 34 - Mod. SF450: removing/installing the lower roller scrapers.....	40
Figure 35 - Mod. SF500: removing/installing the lower roller scrapers.....	41
Figure 36 - Mod. SF600: removing/installing the lower roller scrapers.....	42
Figure 37 - SF450 and SF500: Removing the tables and replacing conveyor belts.....	45
Figure 38 - SF450 and SF500: installing the table support rod between the uprights	46
Figure 39 - SF450 and SF500: preparing the belt before installing the drive roller	47
Figure 40 - SF450 and SF500: installing a conveyor belt drive roller	48
Figure 41 - SF450 and SF500: installing the handle and other parts	49
Figure 42 - Replacing a drive chain.....	50
Figure 43 - Drive chains	51
Figure 44 - Safety micro switches associated with the interlocked guards in the rolling zone.....	52
Figure 45 - Hazards of a mechanical nature	54
Figure 46 - Interlocked guards in front and behind the rolling zone.....	55
Figure 47 - Guards fastened with screws or similar means.....	56
Figure 48 - Sound level measurement points.....	59

All rights reserved. Reproduction in whole or in part of this manual is prohibited.

EC DECLARATION OF CONFORMITY

The company

FLAMIC s.r.l. Via dell'Artigianato, 5 36035 Marano Vicentino (VICENZA) - Italy

(Vat No. and Tax Code 03198710240)

through its legal representative, dott. Michele Stella

HEREBY DECLARES

that the **DOUGH SHEETER** Serial No.

MODEL (see ticked item)			
<input type="checkbox"/> SF450B	<input type="checkbox"/> SF500	<input type="checkbox"/> SF600	
<input type="checkbox"/> SF450BV	<input type="checkbox"/> SF500V	<input type="checkbox"/> SF600V	
	<input type="checkbox"/> SF500B	<input type="checkbox"/> SF600V + ST600	
	<input type="checkbox"/> SF500BV		

the function of which is to roll dough by passing it repeatedly between two rollers, by reversing its direction; the distance between the rollers of which can be adjusted between one pass and another in order to obtain a sheet of the required thickness and (only for the SF600V + ST600) regularly shaped pieces of dough that will undergo further processing outside the machine in order to obtain pastry and bakery products,

complies with the relevant provisions of:

- Directive 2006/42/EC of the European Parliament and of the Council of 17 May 2006 on machinery, and amending directive 95/16/EC (and implemented by the Italian State with Legislative Decree No. 17 of 27/01/2010)
- Directive 2014/30/EU of the European Parliament and of the Council
- Regulation (EC) No 1935/2004 of the European Parliament and of the Council of 27 October 2004 on materials and articles intended to come into contact with food and repealing Directives 80/590/EEC and 89/109/EEC.

The technical file of the machine is held by dott. Michele Stella, as the legal representative.

Dott. Michele Stella
(Legal Representative)

Marano Vicentino,

1 INTRODUCTION

1.1 FOREWORD

This instructions manual is intended be used by anyone who may in any way be assigned to, in charge of or authorized the use and/or control the machine. It is also intended for the employer, managers and supervisors of the company that uses the machine. They should read it carefully and understand it in its entirety so that it can be used as a valid tool for fulfilling some of the obligations required by current laws and regulations regarding health and safety at work.

The employer, managers and supervisors of the staff that are authorized to use the machine must ensure that they receive adequate information and training, including practical training (it must be simple and understandable in relation to the perspicacity that can reasonably be expected from those involved) on its proper and safe use and on both general and specific hazards and/or duties in the workplace.

The manual consists of several sections, which can be broadly summarized as follows:

Instructions for handling, transport, assembly (SF600) and installation

This is covered in the first paragraphs of Chapter 3. It is intended for the personnel who are responsible for handling, transporting, installing and starting up the machine for the first time. Its purpose is to provide all the important information, apart from that which relates to the general level of culture of an experienced and/or professional and/or skilled technician in order for these tasks to be performed correctly.

Use and ordinary maintenance instructions

This is covered in Chapter 2 and part of Chapters 3, 4 and 5. It is intended for the employer of the machine operators, the managers and supervisors of the company that uses the machine and to the operators themselves.

As well as containing general guidelines for using the machine, it also includes instructions regarding maintenance, cleaning and inspection tasks, which, because of their ease and low risk, do not require particular experience or professional skills and can be carried out by the machine operator.

Extraordinary maintenance instructions

This is covered in the remaining part of Chapters 4 and 5. It is intended for the employer of the machine operators, the managers and supervisors of the company that uses the machine, the operators and the specialised personnel who carry out routine and/or extraordinary maintenance on the machine. It includes some important safety instructions that should be followed during maintenance, adjustment and inspections, which due to their complexity and/or dangerous nature, require specialised, experienced and professionally trained personnel who possess the technical and regulatory knowledge to carry them out safely and in a workmanlike manner.

Given the specific experience that the personnel responsible for this type of work must possess, the technical instructions that are not required for safely performing the work are not included. Neither are those which, considering their professional profile, such personnel cannot not be aware of.

Instructions for dismantling and/or disposal

This is covered in Chapter 6.

References made to specific chapters or sections shall also be intended as referring to all the relative sub-sections. Where, for example, section 3.6 is mentioned. 3.6 The reference is to be considered to refer to all sections from 3.6.1 to 3.6.3.

Before carrying out any operation on/with the machine (assembly, installation, operation, repair etc.) read both the general and specific **instructions carefully** that are contained in this manual. Fully understand their purpose and meaning in the context of correctly operating and maintaining the machine and acquire an adequate knowledge of the safety devices provided with it and any residual risks that its use involves.

Keep the manual and any enclosed publications (drawings, diagrams etc.) in a safe place that is known to the personnel authorised to use and/or maintain the machine. Store it in a dry place and protected from atmospheric agents, which over time could cause it to deteriorate (e.g. in an opaque plastic bag). It is recommended to leave a copy close to the machine so that it is available to operators for quick reference.

If the manual is lost or damaged, immediately request a replacement from Flamic s.r.l. clearly specifying all the machine identification data (year of manufacture, model, serial number, etc.).

The manual reflects the state of technology at the time the machine was put onto the market or put into operation and cannot be regarded as inappropriate simply because of later updates based on additional experience or because of new technical solutions.

The manufacturer shall not under any circumstances be held liable for the suitability of the place in which the machine is used and related utilities, even some important instructions are provided in this manual regarding its correct installation. The company reserves the right to make updates to machines and manuals, without implying any obligation to update machines and/or manuals that were previously produced.

WARNING

Once the machine(s) has/have been positioned and/or installed in its/their final location, make sure that all the devices, especially safety devices described in this manual and in any commercial documentation provided, have been fitted before authorising its use or starting it up.

This manual is an integral part of the machine and should accompany the machine if it is sold or transferred for whatever reason, even if it is given away.

The intended 2.1 use of the machine is indicated in section together with details regarding permitted and non-permitted uses.

1.2 INSTRUCTIONS AND GENERAL PRECAUTIONS

Flamic s.r.l. declines all liability for injury or damage to persons, animals or property caused by the failure to comply with instructions, directions, recommendations etc. contained in this manual, and in particular the following:

- **DO NOT tamper** with the machine's safety guards and safety devices
- **DO NOT remove** the guards and **DO NOT disable** the machine's safety devices, unless it absolutely necessary to do so, and with the machine stationary and the power disconnected and maintained in this condition until all the guards and safety devices have been properly replaced/re-enabled, and after having taken all possible measures to minimize risks that may arise
- **Replace** the guards and **re-enable** the safety devices as soon as there is no longer any reason for them to be removed/disabled
- **DO NOT use** the machine for purposes and/or loads other than those indicated by the manufacturer
- **Carry out** daily checks on the guards, safety devices and the general condition of the machine
- **Clean** the machine and its parts thoroughly every day
- **Adopt the necessary safety measures and precautions** when carrying out adjustments, cleaning, maintenance etc. to prevent the machine or its parts from being started by others, even accidentally
- **Comply with** the European Directives and the laws of the country in which the machine is used regarding the workplace. In particular (but not limited to) those relating to safety signs, food hygiene, health and safety in the workplace, personal protective equipment and environmental protection
- **Comply with the permitted limits of the operating environment and conditions:** maximum relative humidity 90%, ambient temperature min. 5°C max. 40°C, maximum altitude 1000 m a.s.l.
- **The employer must** provide employees with adequate information and training, including practical training, regarding the proper and safe use of the machine.
- **The operator should wear only tight-fitting clothing**, without loose parts. Jackets, open shirts etc. or jewellery (rings, bracelets, necklaces etc.) should never be worn. Long hair should be collected (e.g. in a cap) and work clothing must also be appropriate for the hygiene requirements of the food that is handled / processed.
- **Do not allow unauthorised persons, untrained personnel, children or anyone who is not expressly authorised to enter the room in which the machine is used or to approach the machine;**
- when the machine is connected to other equipment or incorporated in a complex assembly, the manufacturer of the assembly resulting from said connection or incorporation must carry out a risk assessment for any additional or greater risks resulting from said operation, take appropriate measures to eliminate or minimize the risk, comply with all the relevant requirements of the Law, Directives, Regulations etc. (including the Directive 2006/42/EC) and declare that the assembly is compliant with them.
- If parts of the machine need to be replaced, **use only original spare parts** by submitting a request to Flamic s.r.l. Flamic s.r.l. will not under any circumstances be held liable for any injuries or damage to people, animals or property caused by the use of non-original spare parts.
- **Any arbitrary modification** made to the machine **shall release the manufacturer from all liability for any injuries or damage to people, animals and/or property** as a result of it.

1.3 MAIN CIRCUMSTANCES IN WHICH THE COMPANY DISCLAIMS LIABILITY

Flamic s.r.l. shall not be held liable for any direct or indirect damage or injury or for the loss of production if/by:

- **the machine is used for purposes** other than its intended use or in ways different from those described
- **installation does not conform** to the manner specified in this manual
- **the machine is used by insufficiency skilled personnel** and, where necessary, not adequately trained for its safe and proper use.
- inappropriate **energy sources** are used or that are anyway **different** from those indicated in this manual and/or the enclosed documentation (e.g. wiring diagrams)
- **the lack of or poor maintenance** or if it is not carried out in the manner indicated herein
- **the failure or partial failure to comply with the instructions** provided in this manual
- the **arbitrary modification** of the original characteristics and equipment of the machine without having received a formal authorization from the manufacturer.
- **the connection/incorporation** with/of the machine with parts and/or equipment applied or otherwise to the machine that are **not supplied, intended or authorized** by Flamic s.r.l. In this case, the CE marking placed on the machine by the manufacturer, it would no longer be valid.

- **the incorporation** of the machine or its parts into a complex assembly, if this were to cause new or increased risks compared to the machine if used on its own as it was supplied.
- **failure to comply with laws and regulations** in the country in which the machine is used
- **exceptional events and force majeure** beyond the control of Flamic s.r.l.

1.4 TERMINOLOGY

In order to improve the understanding of the manual, below we have defined some of the terms and expressions used in it:

OPERATOR: person assigned to use the machine or its parts.

MACHINE, DOUGH SHEETER: the subject of this manual

USE OF THE MACHINE: every operation performed or that can be performed with/on the machine within the permissible limits and stated in this manual. The term assumes the meaning of the relevant subject that is dealt with from time to time (for example, production, maintenance, cleaning etc.).

CUSTOMER: natural or legal person who purchased the machine from Flamic s.r.l.

USER: natural or legal person that actually uses the machine, in particular for production purposes

MANUFACTURER of the machine, **FLAMIC:**

Flamic s.r.l. Via dell'Artigianato, 5 36035 Marano Vicentino (VICENZA) - Italy

PPE: personal protective equipment (e.g. gloves, shoes, glasses etc.)

INGREDIENTS: food products/substances (e.g. animal/vegetable fats, flour etc.) added to dough during the rolling process in order to obtain a new mass of sufficiently homogeneous dough.

DOUGH: homogeneous easily malleable mixture at room temperature (obtained mainly from processes external to the machine, but also in certain cases with the addition of ingredients to be incorporated in the mixture with the machine itself) to undergo progressive rolling in order to obtain a sheet of dough/pastry of the required thickness.

SHEET, DOUGH SHEET: dough sheet made using the machine during the various rolling stages by passing the dough forward / backward between two rollers, the distance between which (rolling thickness) is adjusted by the operator according to requirements.

DOUGH PIECES/SHAPES: pieces of regularly shaped dough (triangular, circular, etc.) produced by the cutting unit to be sent for subsequent processing outside the machine.

ROLLERS (THICKNESSING): powered opposing metal cylinders with a mutually opposite rotational movement which, by compressing the dough in the various forward / backward steps and from time to time by varying the gap between them, enables the sheet of the required thickness to be obtained.

ROLLING THICKNESS: the distance (gap) between the rollers.

BENCH, TABLE, SURFACE: machine element consisting essentially of a flat structure with two cylinders at each end on which a conveyor belt moves. In this manual, this term refers to the assembly consisting of the structure, cylinders, conveyor belt, residue collection tray (under-table), catch pan, table support etc.

CONVEYOR BELT, BELT: mobile component, the function of which is to receive the dough from the rollers and to forward it to the subsequent rolling stage by reversing its direction of movement.

SCRAPER: plastic plate, the edge of which is in contact with a roller, parallel to its axis and whose function is to keep the roller as free as possible from residues of dough, flour etc. by producing a "scraping" action. There are two scrapers for each roller

BASE, FRAME: metal structure that supports the other parts of the machine

CONTROLS SIDE: the side of the machine on which the rolling thickness adjustment handle is located.

RESIDUE COLLECTION TRAY: edged metal sheet located under the table for collecting dust and residues of dough

CATCH PAN: concave stainless steel sheet at the ends of the benches that supports the rolled dough that would otherwise fall on the floor during processing.

ORDINARY MAINTENANCE: operations carried out to keep the machine in good condition and in working order that do not require special training or specific skills and that can be carried out by unskilled personnel, provided that the instructions in this manual are followed.

SPECIAL / EXTRAORDINARY MAINTENANCE: work carried out to keep the machine in good condition and in working order that do require special training and/or specific skills and that can and must only be carried out by skilled personnel and (where required by the law and current regulations) professionally trained personnel who possess the technical and regulatory knowledge to carry them out safely and in a workmanlike manner.

DANGER ZONE, any zone within and/or around the machine in which the presence of an exposed person constitutes a risk to the health or safety of that person.

EXPOSED PERSON, any person wholly or partially in a danger zone.

WARNING: very important information regarding health and safety

IMPORTANT: important information regarding the use and care of the machine

1.5 VALIDITY OF THE CE MARKING AND EC DECLARATION OF CONFORMITY

In this manual, all references and/or information regarding:

- CE marking
- EC declaration(s) of conformity
- declaration(s) of incorporation of partly completed machinery
- directives and regulations issued by the institutional bodies of the European Union (Parliament, Council, Commission etc.) and related acts of transposition of the EU Member States
- harmonised European standards (EN)

are to be considered valid only for the machines intended for sale in the European Union or for which compliance with laws, directives etc. issued by the European Union has been specifically requested by the customer and formally accepted by Flamic s.r.l.

For all the machines that are not intended for use in the European Community, with the exceptions mentioned above, these references and indications should be considered to be totally meaningless and of no value.

2 CHARACTERISTICS OF THE MACHINE

2.1 DESCRIPTION AND INTENDED USE

The "Sheeter" is intended to be used to roll a batch of dough by passing it repeatedly through two opposing rollers by reversing its direction. The distance between the rollers can be adjusted between one pass and another in order to obtain a sheet of the required thickness. It is also possible (only for the SF600V + ST600) to produce regularly shaped pieces of dough that will undergo further processing outside the machine in order to obtain pastry and bakery products.

The machine has been designed for professional use only in places that are not accessible to the general public, untrained persons, children, unauthorized persons etc., unless in the case of trade fairs and/or demonstrations and, in any case, only after having taken suitable precautions to prevent the persons present from being exposed to risks.

Do not use the machine for purposes and/or products and/or in ways other than the one(s) specified

Do not use the machine before all connections have been made to the utilities at the installation site, as required in this manual.

Do not use the machine in environments in which there is:

- a risk of fire and/or explosion or anyway a risk of major accidents occurring and close to open flames
- high humidity and/or wet
- excessive steam
- excessive oil vapour
- excessive dust
- corrosive substances and/or gasses
- adverse climatic conditions

Do not use the machine in places in which there is dust (except for the dust generated by the machine itself, which is anyway a minimal amount) and/or airborne substances, especially if hazardous to human health or that could contaminate the product processed by the machine.

Do not use the machine next to open flames (e.g. burners), sources of sparks (e.g. welding machines), heat sources (e.g. heaters).

Do not use the machine in areas that are subject to vibration (other than that of the machine) or abnormal shocks

Do not use the machine outdoors or in places that are inadequately protected against atmospheric agents

Do not use the tables of the machine as work tables on which to use excessive force or anyway beyond those of the normal intended use of the machine; for example by exerting a continuous force (when resting on it) or an impulsive force (beating using rigid bodies) on masses of dough to reduce their height).

Do not leave the dough or any other product, ingredient etc. on the benches for longer than 30 minutes (even if not continuously).

Do not use the machine if it is connected to other equipment or incorporated into other machinery before the manufacturer of the assembly has declared that the final machinery is compliant with the relevant requirements of the law, directives, standards, etc.

For reasons of health, safety and for the guarantee to be valid, **do not use the machine for products and/or materials and/or in ways other than** those described in this manual, **or anyway for purposes other than its intended use. Any use other than that stated here is to be considered incorrect, improper and not intended by the manufacturer and therefore potentially dangerous for the health and safety of exposed persons, as well as for animals and/or property.**

With reference to Figure 1, the main parts that make up the machine are:

ref. 1 support structure

ref. 2 tables with conveyor belts

ref. 3 rollers

ref. 4 interlocked mobile guards to protect the infeed zone to the rollers ref. 3. The part furthest from the rollers can be raised and the guard can be rotated about a horizontal axis parallel to the rollers at the part closest to the rollers.

ref. 5 flour tray

ref. 6 rolling pin supports

ref. 7 control devices

ref. 8 table supports (only SF600 and SF500, excluding version B). Referred to as "supports" from here onwards.

Ref. 9 residue collection trays (See section 1.4). These are separate from the catch pans ref. 13 only on models SF500 and SF600, whilst on mod. SF450 it is integral with the catch pan and therefore moves with it.

ref. 10 manual start and reverse control device:

- joystick type (models SF450 and SF500)
- lever type (model SF600)

ref. 11 start and reverse control pedal (only SF600 and SF500, excluding version B)

ref. 12 lever (handle) for regulating the rolling thickness (see section 2.5).

ref. 13 catch pan (see section 1.4). On model SF450 it is integral with the residue collection tray.

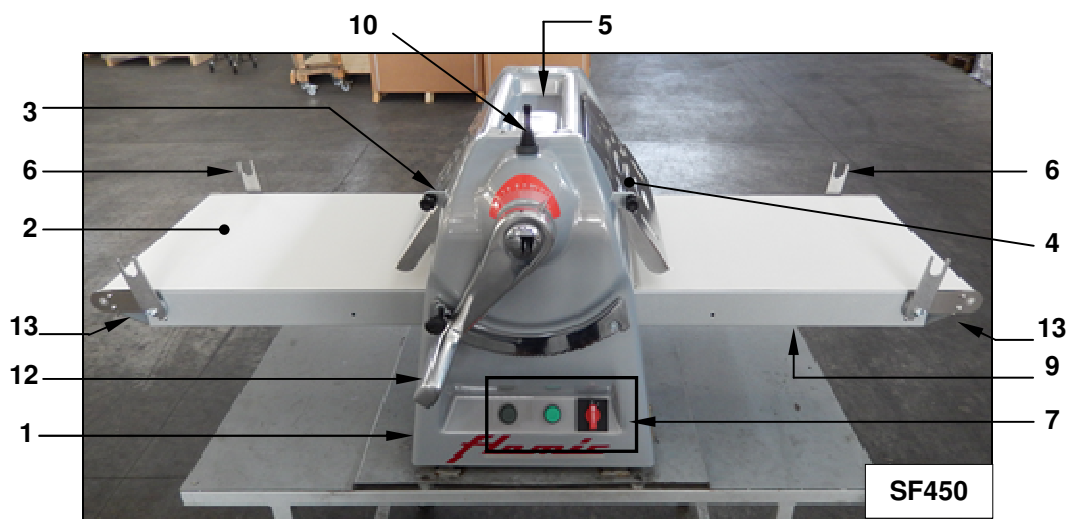
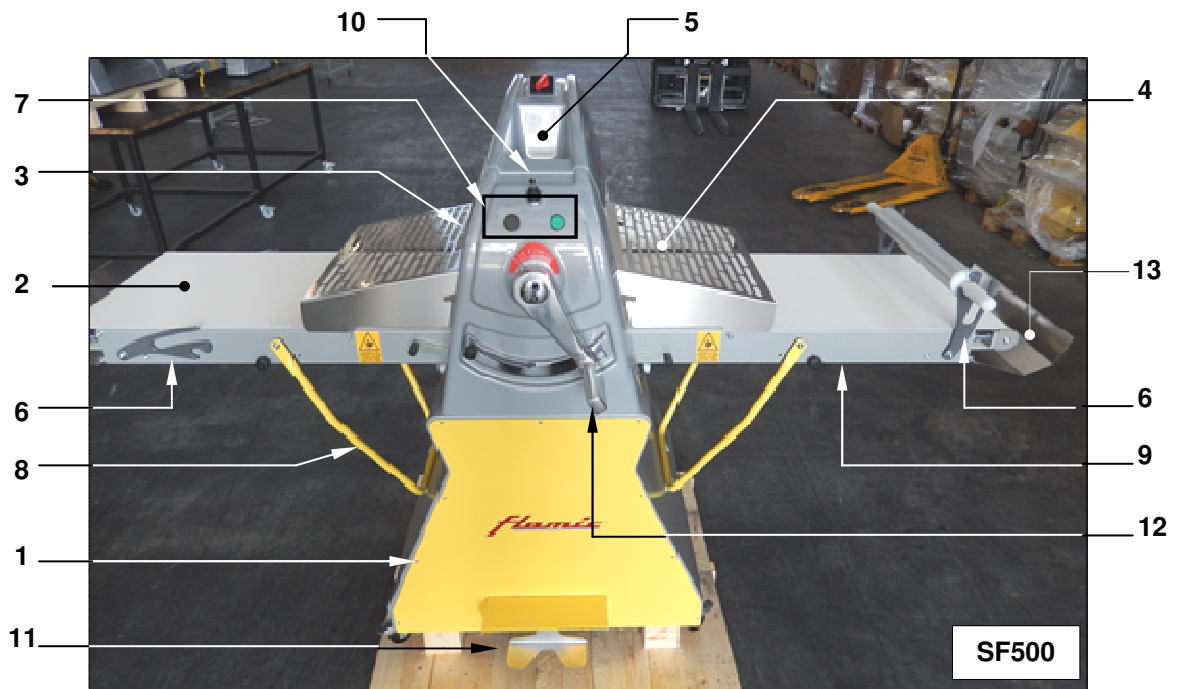
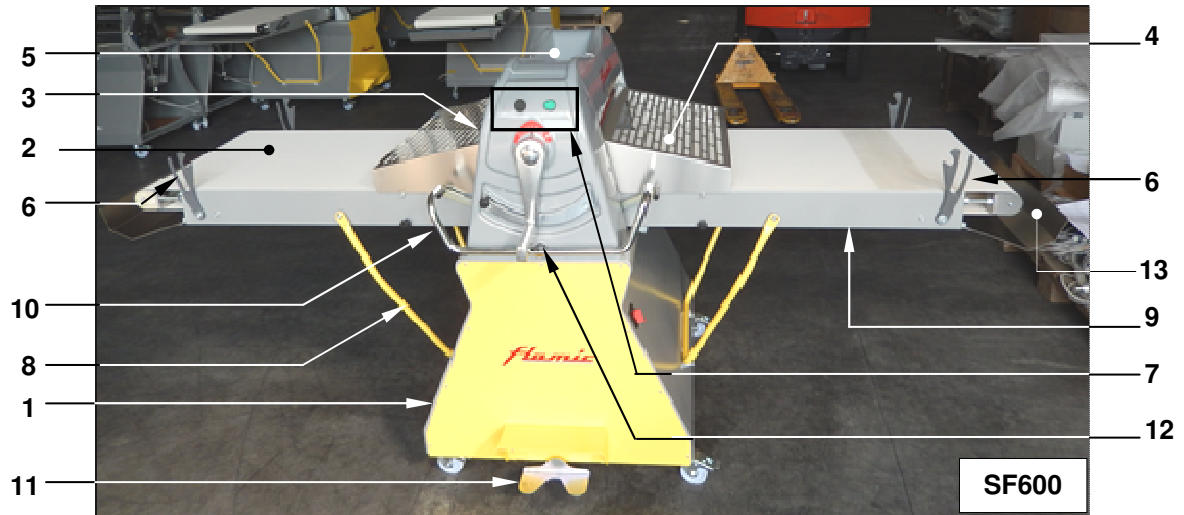

Figure 1 - Main parts of the machine

All rights reserved. Reproduction in whole or in part of this manual is prohibited.

2.2 MACHINE MODELS AND VERSIONS

There are three models of the sheeter, based mainly on the width of the conveyor belts.

SF450: belt width 450 mm

SF500: belt width 500 mm

SF600: belt width 600 mm

The letters "B" and/or "V" may be added as a suffix to the aforementioned machine identification codes. Their meanings are as follows:

B "bench" type machine that can only be used if placed on a raised surface. Its small size and in particular its height, means that it cannot be used when placed on the floor.

Model SF450 is only a "B" type machine. Upon request, Flamic can supply a trolley, shown in Figure 2, to place it on. This makes the height of the top of the tables approximately 1010 mm from the floor.

Model SF500 can be supplied as a version "B" machine.

Model SF600 is never supplied as a version "B" machine.



Figure 2 - Support trolley for SF450B

V variable speed machine (only for 230 V single-phase)

Example: mod. SF500BV = "bench type" adjustable speed sheeter with 500 mm wide conveyor belts.

2.3 CUTTING UNIT ST600 (OPTIONAL)

This device is shown in Figure 3. This unit is used to make pieces of dough from the sheet produced by rolling, that are to be subsequently processed to make specific products. The most common of these are triangular pieces that are used to make croissants.

The unit can be installed only on the SF600V machines that have been prepared specifically for it and specifically requested by the customer at the time the order was placed. It is not possible to install the cutting unit on machines that were not originally designed for it without making considerable modifications to them.

The cutting unit consists essentially of:

- ref. 1 cutting discs mounted on a single shaft in the direction in which the sheet moves
- ref. 2 cutting roller (Figure 3 shows a roller for cutting triangular shaped pieces of dough)
- ref. 3 manual device for regulating the cutting force of the discs ref. 1 against the bench.
- ref. 4 manual device for regulating the cutting force of the roller ref. 2 against the bench.
- ref. 5 disc ref. 1 and roller ref. 2 guard. This acts as a support structure for the discs ref. 1 and rollers ref. 2
- ref. 6 release lever to release the cutting unit from the bench so that it can be raised.

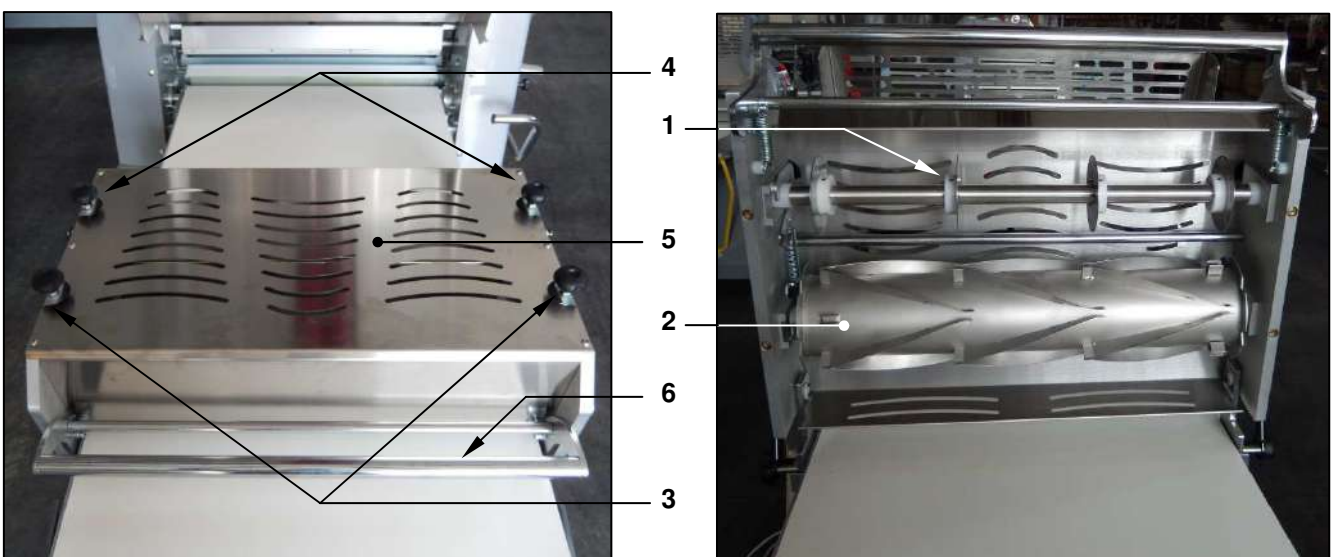

Figure 3 - Cutting unit

2.4 CONTROL DEVICES

With reference to Figure 4, the machine's control devices are as follows:

ref. 1 main switch (selector), two-position: 0 = OFF I = ON

ref. 2 main enable/**START** push-button (green): before pressing it make sure that the start and reverse device(s) ref. 5 and ref. 6 are in neutral.

ref. 3 stop button: pressing it stops the machine and disconnects power to the motor.

ref. 4 (only version "V") graduated continuous operating speed adjustment knob.

ref. 5 manual start and reverse control device (ref. 5/L lever, ref. 5/J joystick)

ref. 6 start and reverse control pedal (excluding version "B", bench top)

The conveyors move towards the side to which the lever ref. 5/L has been lowered, the joystick has been moved ref. 5/J or the pedal ref. 6 has been pressed. Bringing the lever, the joystick or control pedal to the central neutral position, or pressing the button ref. 2, stops the machine if it is moving.

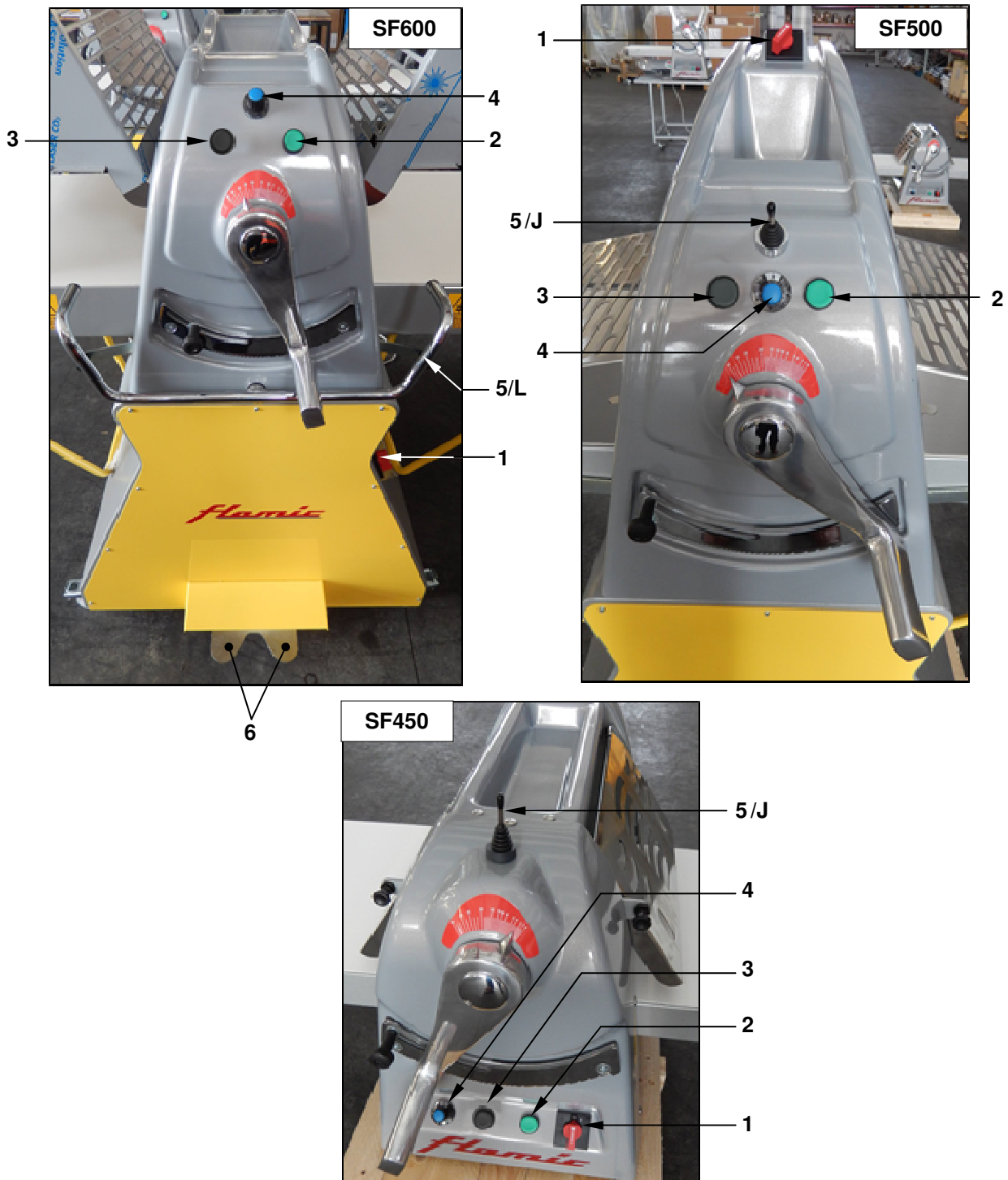

Figure 4 - Control devices

2.5 ROLLING THICKNESS ADJUSTMENT LEVER (HANDLE)

With reference to Figure 5, adjusting the position of lever ref. 1 (handle) modifies the distance between the rollers and allows the thickness of the sheet of dough to be regulated. Turning the handle clockwise decreases the rolling thickness, turning it anticlockwise increases it.

There is a graduated scale ref. 2 above the axis of rotation of the lever, the pointer of which ref. 3, provides an indication of the rolling thickness.

To move the lever ref.1 you must press and hold the locking lever ref.4 under the handle. When the locking lever is released, the tooth ref. 5, pushed by a spring, will tend to be inserted into one of the notches on the bottom of the rack ref. 6. This will allow the handle to remain in a fixed position during the rolling process and keep the rolling thickness constant. If the handle is released in an intermediate position between two adjacent notches on the rack ref. 6, the force exerted by the dough against the upper roller may cause it to move, but only until the tooth ref. 5 encounters the first notch.

The minimum required rolling thickness can be set using the limit stop ref. 7. It can be moved manually along the slot ref. 9 after loosening the knob ref. 10. Once the correct position has been found, secure it in place using the knob ref. 10. In this way, the limit stop ref. 7 will act as a mechanical stop for the handle ref. 1.

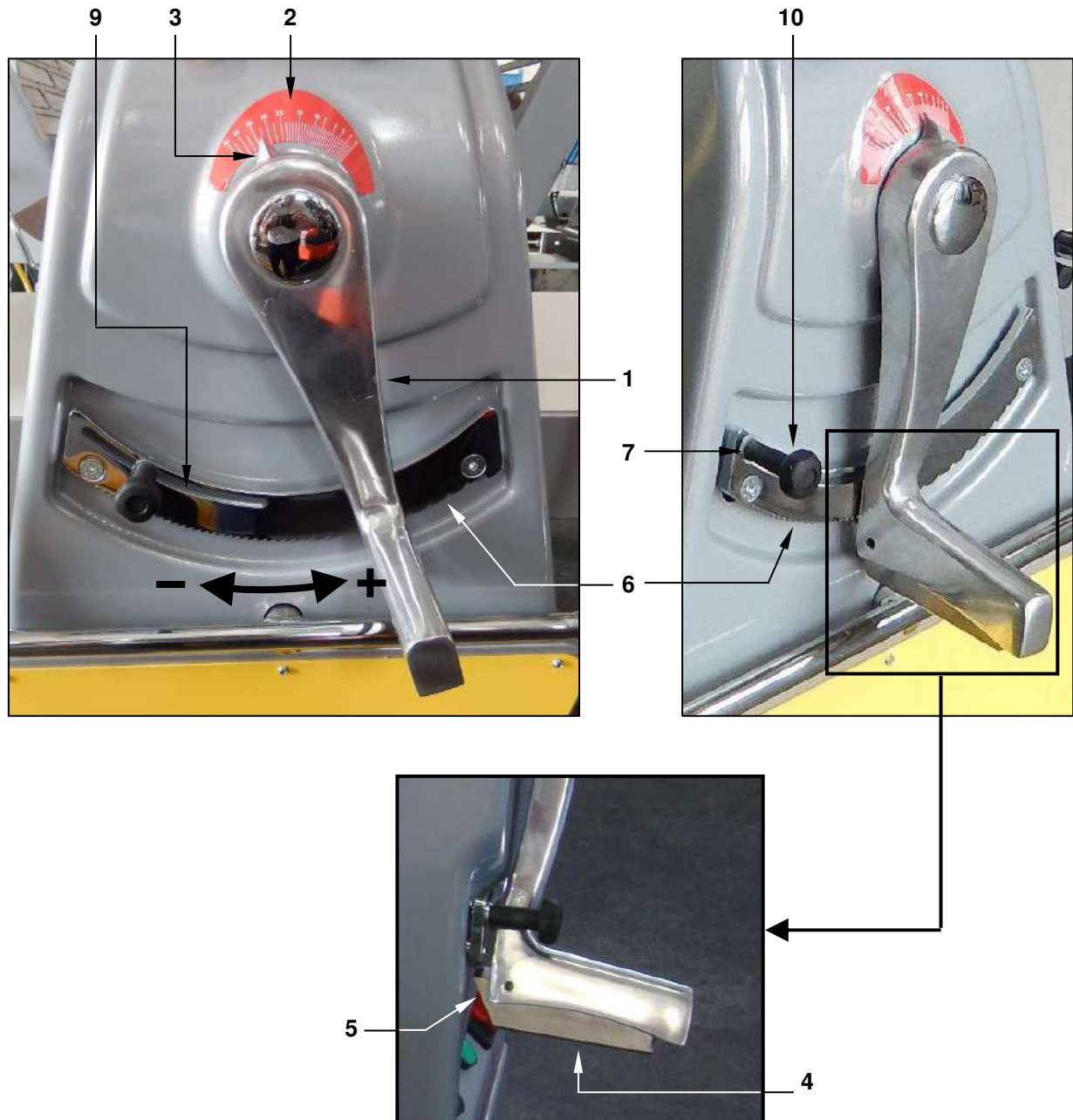

Figure 5 - Rolling thickness adjustment

2.6 MAIN TECHNICAL SPECIFICATIONS

Principal dimensions of the machines												
Model	BL	BW	A	B	C	D	E	F	G	H	L	M
SF450B	500	450	1120	1280	-	-	700	870	540	690	-	430
SF500B	850	500	1250	1860	2110	150	770	910	620	880	950	455
	1000	500	1250	2160	2410	150	770	910	620	1030	1000	455
SF500	850	500	800	1860	2110	880	770	910	1335	1620	950	-
	1000	500	800	2160	2410	880	770	910	1335	1760	1020	-
	1200	500	800	2560	2810	880	770	910	1335	1920	1180	-
SF600	850	600	800	1860	2190	900	920	1065	1225	1619	960	-
	1000	600	800	2160	2490	900	920	1065	1225	1757	1100	-
	1200	600	800	2560	2890	900	920	1065	1225	1940	1250	-
	1400	600	800	2960	3290	900	920	1065	1225	2123	1400	-
	1600	600	800	3480	3810	900	920	1065	1225	See Note		-

Note. When not in use, the BL ≤ 1400 mm tables can be folded for storage. The BL > 1400 mm tables can only be positioned horizontally.

Key

BL = conveyor belt length

BW = conveyor belt width

For all other parameters see Figure 6

Other technical specifications								
Model	Weight t ★	with packaging ★★		Roller diam.	Rolling thickness ★★★		Nominal power	Max belt speed
		Weight	Dimensions		min.	max		
	[kg]	[kg]	[cm]	[mm]	[mm]	[mm]	[kW]	[cm/s]
SF450 B	95	111	93 x 55 x 112	60	0	35	0.55	50
SF500 B	132	154	100 x 100 x 116	60	0	35	0.55	50
SF500	186	215	97 x 97 x 218	60	0	35	0.55	50
SF600	247	283	120 x 120 x 165	70	0	40	0.75	50
Cutting unit	23	30	70 x 51.5 x 23.5					
Trolley for SF450 B			70 x 50 x 74					

★ with maximum bench length

★★ thick gauge cardboard box on pallet

★★★ The minimum rolling thickness can be adjusted down to zero (in this case, the force exerted by the passage of the dough would tend to slightly “separate” the rollers because it creates a small gap for it to pass through. The minimum thickness used anyway depends on the type of dough being processed.

Maximum batch size: SF450: 3 kg

SF500: 5-6 kg

SF600: 7-8 kg

POWER SUPPLY

All machines except version “V”

3-phase + earth (L1 + L2 + L3 + PE)

Supply voltage: 230 Volt or 400 Volt

Frequency: 50 Hz, 60 Hz

Version “V” machines

Single phase + earth (L + N + PE)

Supply voltage: 230 Volt

Frequency: 50 Hz, 60 Hz

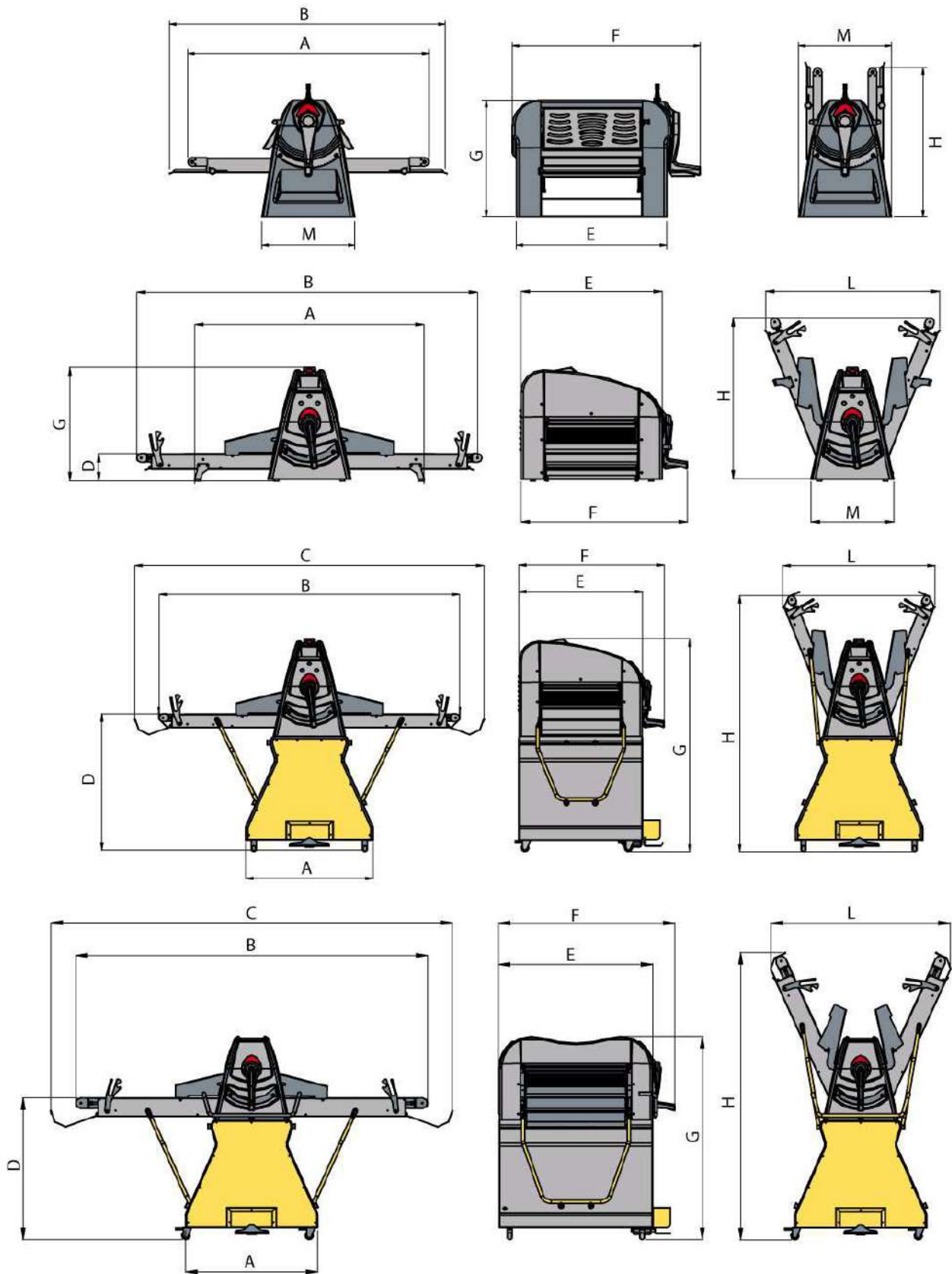

Figure 6 - Dimensions

2.7 IDENTIFICATION PLATE

The CE marking, manufacturer's data, serial number, year of construction, weight and electrical data have been indelibly marked (screen printed and punched) on the data plate, shown in Figure 7, which has been fixed permanently (via screws or rivets) to the machine in the position indicated in the same figure.

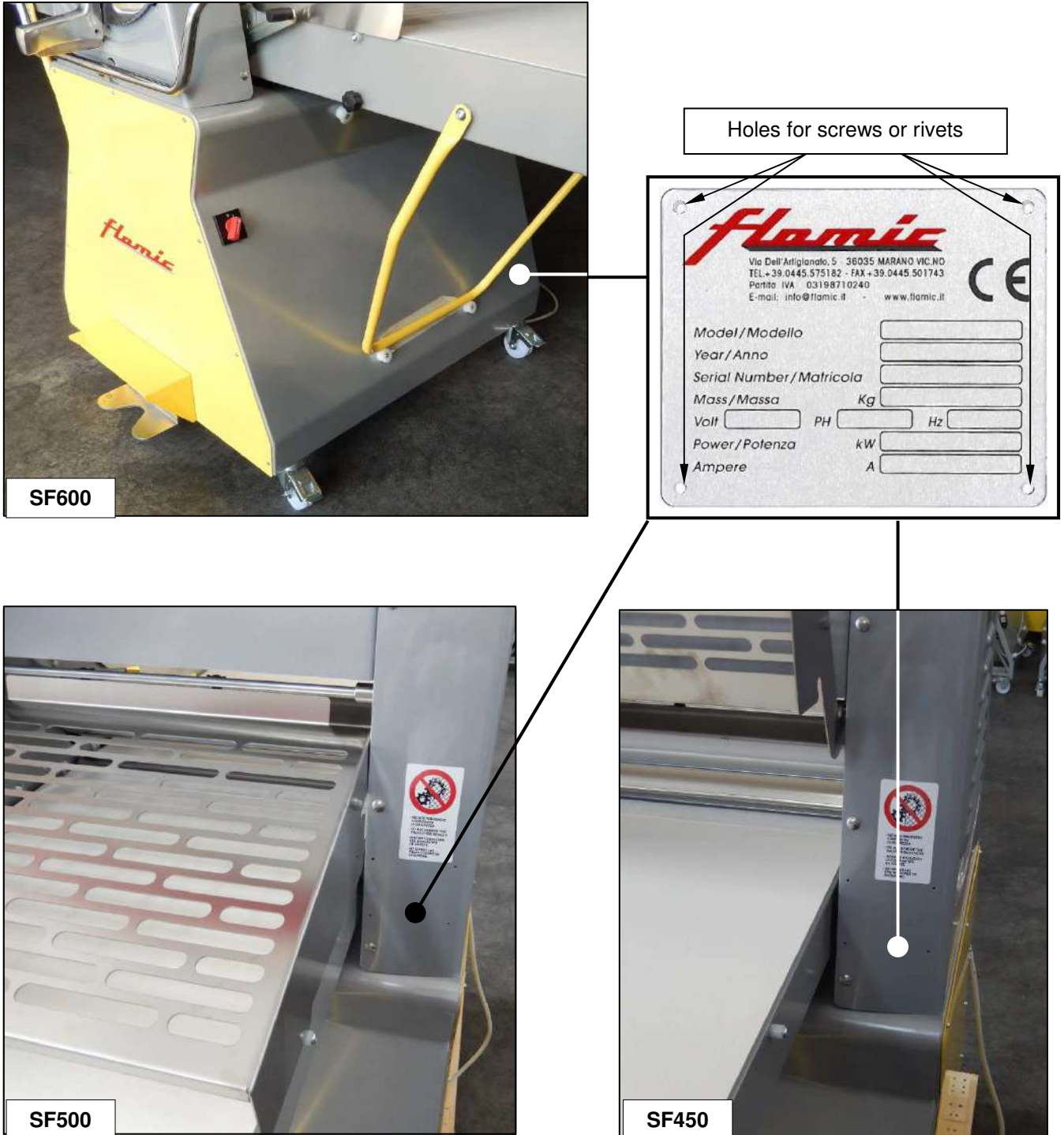

Figure 7 - Identification plate and its position

3 INSTALLATION AND USE

3.1 INSTRUCTIONS REGARDING THE PLACE OF INSTALLATION

The place in which the machine is to be kept and/or used must comply with the applicable law and provide adequate protection against impact, damage, deterioration and atmospheric agents. Access routes to the place of installation must be of a size and type to allow the machine to pass easily without the risk of causing injury to people or damage to the machine itself. The floor, supporting structures and walls must have characteristics that are compliant with laws and regulations, also in consideration of the overall load that is to be supported and relative safety coefficients. The floor and walls of the room must be easy to clean and, if it necessary, to disinfect and disinfest. The floor must be flat, not sloping, solid and free from holes and bumps. The electrical system and the equipotential protection circuit (ground) of the site must comply with current laws and regulations. They must be installed, maintained and, if required by law, inspected by authorised and professionally qualified technicians who are able to issue a declaration of conformity. Suitable safety devices must be installed on the upstream power supply panel to provide overcurrent and short circuit protection and, if necessary, against phase-phase, phase-neutral (if applicable) and phase-ground failures.

3.2 TRANSPORT, HANDLING AND POSITIONING

Depending on the destination and the contractual agreements, the machine will be shipped:

- wrapped in "bubble wrap", stretch film and fixed to a pallet (see example in Figure 8/A)
- without wrapping materials, fixed to a pallet (see example in Figure 8/B)
- only wrapped in "bubble wrap" and stretch film (without pallet)
- without wrapping materials, contained in thick gauge cardboard box fixed to a pallet
- (by sea) in a "barrier bag" and a thick gauge cardboard box fixed to a pallet.

The load should be secured to the floor of the transport vehicle using suitably positioned wooden blocks and/or lashed above 2/3 of its height to fastening points on the vehicle to prevent it from moving during transport. To handle the machine when it is on the wooden support (pallet, packaging base with carton etc.) use a forklift truck having an adequate lifting capacity for the total weight to be lifted (see section 2.6). Insert the forks inside the end stringers and as close as possible to them to avoid sideways movements (be careful not to damage parts of the machine).

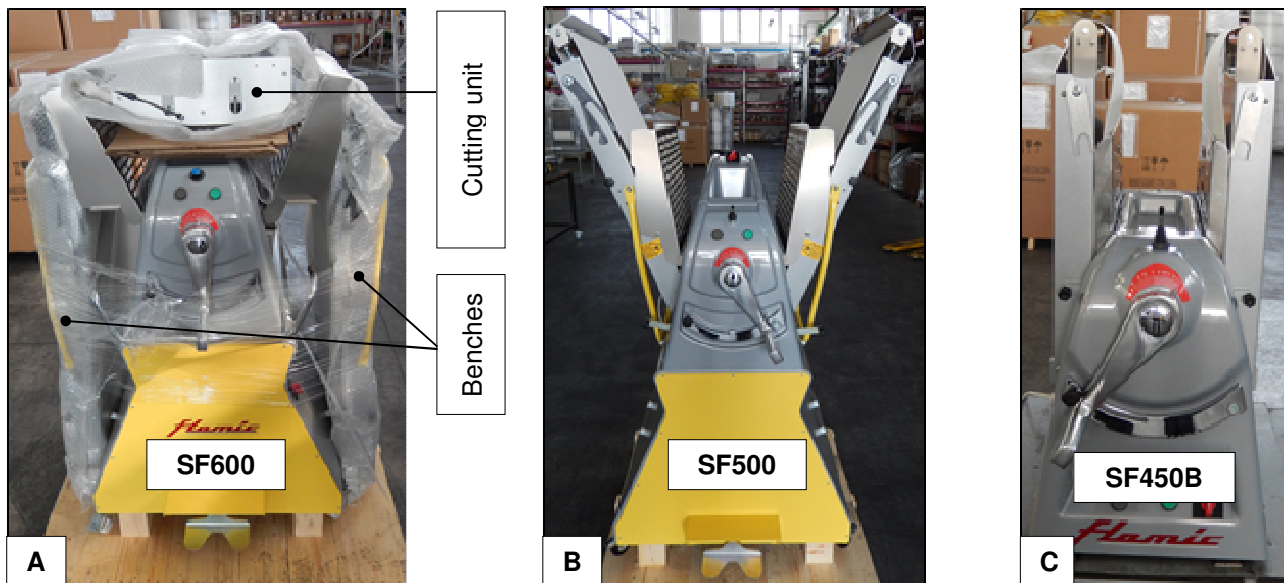

Figure 8 - Handling the palletised machine using a forklift truck

Remove the machine from its packaging, separate the materials by type (plastic, wood etc.), place them in a storage area that is only accessible to authorised personnel and arrange for disposal according to current regulations.

In Italy and other countries, especially in the European Union, waste disposal and environmental protection regulations are clearly defined by current legislation.

Check that the machine and its parts are intact. If in doubt, consult the manufacturer.

To lift the machine on its own (e.g. to move it from the pallet and place it on to the floor):

- model SF450: the benches must be in the folded position and secured (see section 3.5.1). Place two slings ref. 1 having a suitable lifting capacity (the weight of the machine is indicated in section 2.6, as well as on the plate), under the crosspieces ref. 2 (one on each side) as shown in Figure 9. Then connect them to lifting equipment with a hook, such as a crane, hoist, etc. **(do not for any reason connect them to the forks of a forklift truck).**

The distance between the crosspieces ref. 2 and the lifting hook must be at least 2000 mm. The smaller the angle formed by the slings, the lower is the pressure exerted on the raised tables (lower risk of damage) and the lower is the possibility of them approaching one another (the lower the risk of the load tipping and falling).

- models SF500, SF500B and SF600: insert the forks of the forklift truck from the side opposite the controls, inside and as close to the points at which the base rests on the floor (wheels for SF500 and SF600, feet for SF500B). The forks must protrude by at least 200 mm from the opposite side.
 Model SF600 machines are shipped with the benches dismantled and packaged together with the rest of the machine. The cutting unit, if ordered, will also be included in the same package (see Figure 8/A).
 Models SF450 and SF500 are shipped with the benches installed and folded (Figure 8/B-C).
 Accessories and optionals are usually packaged together with the machine.

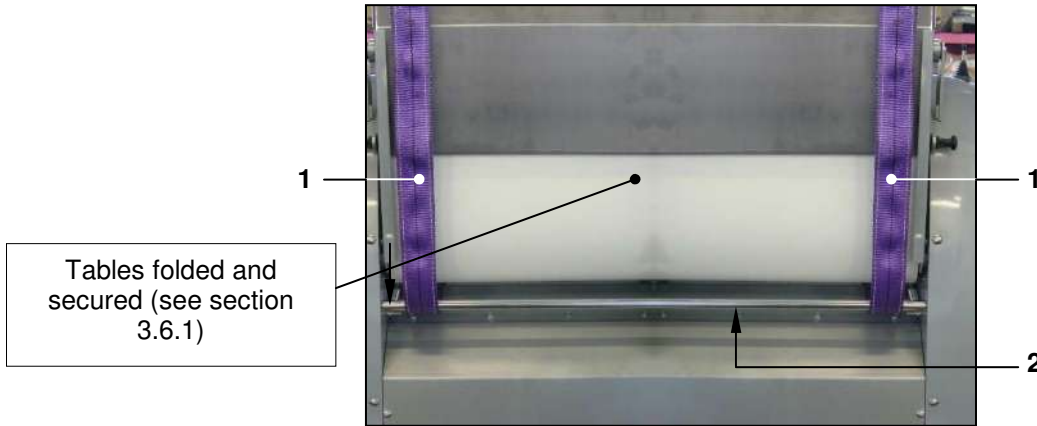

Figure 9 - Lifting slings for model SF450

WARNING

Do not use handling devices and/or systems other than those described here. The removal of packaging materials, handling and positioning should and must only be carried out by skilled personnel (mechanical technicians, handling equipment operators trained to use forklift trucks) **that are wearing safety footwear with reinforced toecaps and a puncture-resistant sole** (because of the possible presence of nails), **abrasion resistant work gloves and a hard hat.**
When handling and/or transporting the machine or its parts, take all the necessary precautions to avoid or to minimize risks to people, animals and property.

Only lift the machine as much as is strictly necessary, avoid jolting it and place it on the floor as soon as possible. The machine is fitted with 4 wheels (except for version "B") so once on the floor, it can be moved by simply pushing it.

WARNING

When moving the machine on its wheels, the tables must be in the lowered position and, if for any reason, they need to be raised (for example to save space during storage) **it should be done only at the last moment.**
Moving the machine on its wheels with the benches in the upright position may pose a tipping over and falling hazard (for example if it were to hit an obstacle on the floor or a wheel were to go into a hole in the floor) **and the impact could cause severe bruising to the exposed persons.**
 The same applies for model SF450 machines that are mounted and properly secured on the trolley (optional) supplied by Flamic (see [Figure 2](#)).

When positioning the machine, leave adequate clearance around it, not only for work related to production, but also for any other work that needs to be carried out, for example, cleaning. It is usually sufficient to leave 1000 mm of free space on each side, unless the machine is at the edge of an escape route, in which case at least 1200 mm of space should be left. All doors close to the machine must be unobstructed and easy to open. The same applies to doors of furniture, appliances, machines etc. Before using the machine, lock the wheels (if present) with the brake levers ref. 1 Figure 10

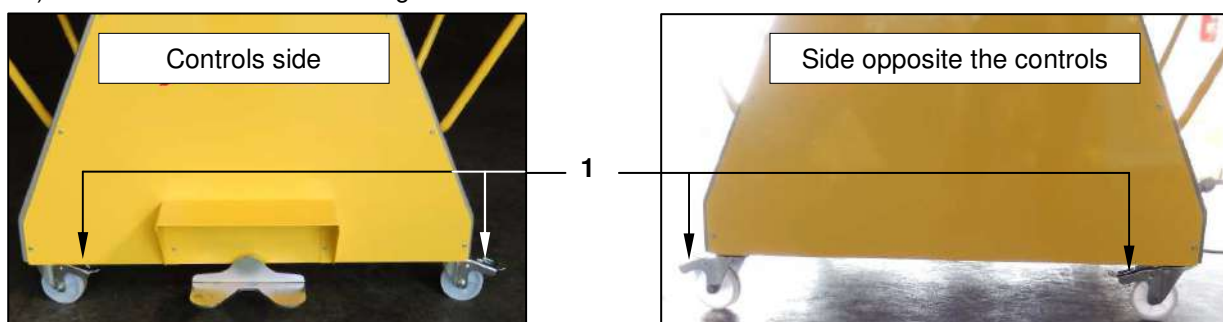

Figure 10 - Wheel brake levers

3.3 ELECTRICAL CONNECTIONS

All electrical work in connection with the machine and/or the place in which it is used, must be carried out by skilled and experienced technicians, who possess the technical and regulatory knowledge to carry it out safely, in a workmanlike manner and according to the law. If required, they must also issue a declaration of conformity provided for by law.

When the machine is delivered and anyway before connecting it to the mains power supply, **make sure that the mains voltage is the same as that indicated by the manufacturer** on the identification plate (section 2.7) and in the wiring diagrams.

The machine is supplied with a power cable and usually with a plug. If at the request of the customer, the machine is supplied without a plug, it is up to the customer to take responsibility for providing a suitable plug for the electrical outlets on site. Obviously it must also be suitable as regards polarity and current (assign this task to an experienced electrician) according to the indications and information provided on the wiring diagram and on the machine identification plate.

Use an earthing system, the working order of which must be checked periodically. Do not connect to gas or water pipes or to other generic metal parts.

Keep the power cable away from hot and/or moving parts. It should not obstruct the passage of people, animals or things.

The plug must be easily accessible and clearly visible at all times from any position in which the operator could find himself/herself, even if only a short time.

For machines using three-phase power, when the machine is first started up, check the direction of rotation of the motor: the conveyor belts must move according to the start control and reverse device as described in section 2.4. If this is not the case, invert two phase wires (**be careful not to swap a phase wire with the earth wire**, the latter can be recognized because it is yellow-green).

Some indications for doing this are shown in Figure 11:

- Separate the cap of the plug from the terminal block
- Pass the cable through the hole at the top of the cap, then connect the individual conductors to the plug terminals
- tighten the terminals and close the terminal block with the cap, as shown in Figure 11.

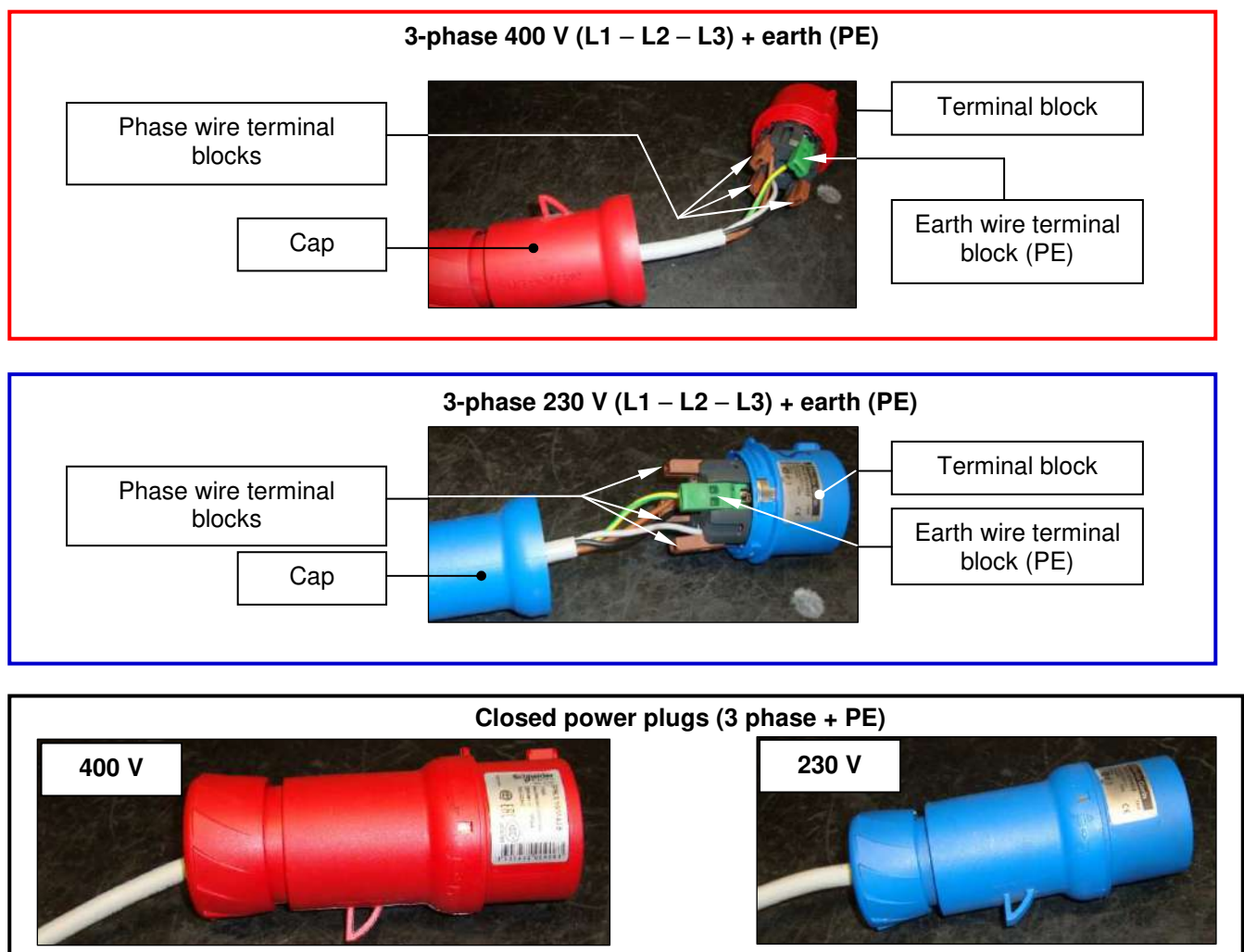

Figure 11 - Power cable plug

3.4 INSTALLING/REMOVING THE TABLES OF A SHEETING MACHINE (MOD. SF600)

The instructions 3.4.1 for installing the tables of a model SF600 sheeting machine are given in section 3.2, which, as explained in section , when supplied by Flamic, have to be installed on the machine (even if they are received in the same package. See Figure 8/A).

Instructions 3.4.2 for their removal are given in section

Models SF450 and SF500 on the other hand, are supplied with the tables already installed. Their removal and installation, which is only necessary for maintenance purposes (for example to replace the conveyor belts), involves complex tasks which must be carried out by FLAMIC technicians, or anyway by very experienced (**special/extraordinary maintenance**) mechanical technicians. The instructions are given in section 4.6.

The installation/removal of tables for model SF600 machines requires two operators at the same time to carry out the work, of which at least one has mechanical installation experience. The second operator is required to help support the table while the work is being carried out. Before starting, lock the wheels of the machine with the brake levers (see Figure 10) and **wear at least safety footwear with reinforced toecaps and abrasion resistant work gloves**.

To make the work easier, completely raise the interlocked guards in the roller infeed zone (see section 3.5.2).

3.4.1 INSTALLING A TABLE (MOD. SF600)

Wear at least the PPE indicated in section 3.4. With reference to Figure 12, raise the guard ref. 6 completely (see section 3.5.2) on the side on which the table is to be installed (photo A) and remove the scraper ref. 7 (section 4.5 and section 4.5.2.3).

The table must be kept in a horizontal position by holding it at points far enough apart so that it can be easily supported. Whilst operator **X** supports his side of the table ref. 1, operator **Y** (experienced mechanic), whilst also supporting the table, engages the end of the roller ref. 3 with the cylinder ref. 2 that protrudes from the upright. He must then push the bench in the direction indicated by the arrow F1 in order to compress the spring (not visible in the figure) that pushes the cylinder ref. 2 outwards. Immediately afterwards (almost at the same time) he must move the bench in the direction indicated by arrow F2 so that the cylinder ref. 5 is inserted in the other end of the roller ref. 4. Rest the table in a horizontal position on its support (section 3.6.3). Then install and fasten the scraper ref. 7 (see section 4.5 and section 4.5.2.3).

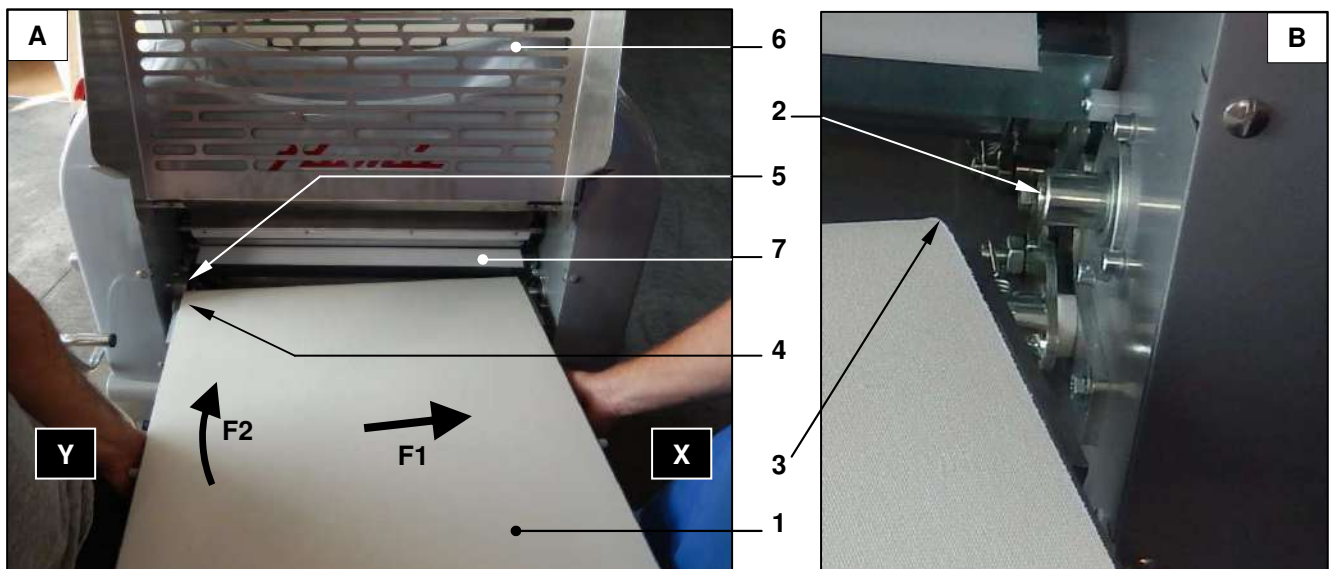

Figure 12 - Installing the benches (mod. SF600)

3.4.2 REMOVING A TABLE (MOD. SF600)

Wear at least the PPE indicated in section 3.4. The bench must be in a horizontal position.

With reference to Figure 13, raise the guard ref. 6 completely (section 3.5.2) on the side on which the table is to be removed (photo A) and remove the scraper ref. 7 (section 4.5 and section 4.5.2.3). The operators must position themselves at the side of the table and hold it at points far enough apart so that it can be easily supported once it has been released.

Lift the table slightly so that it is not resting on its support.

Whilst operator X supports his side of the table ref. 1, operator Y (experienced mechanic), whilst also supporting the table, must push it in the direction of the arrow F1 in order to compress the spring (not visible in the figure) that pushes the cylinder ref. 2 outwards. Immediately afterwards (almost at the same time) he must move the bench in the direction indicated by arrow F2 in order to disengage the other end of the roller ref. 4.

The bench ref. 1 can now be removed. Place it in a stable position and take appropriate measures to prevent it from tipping over and falling and protect it from shock, impact, damage, etc.

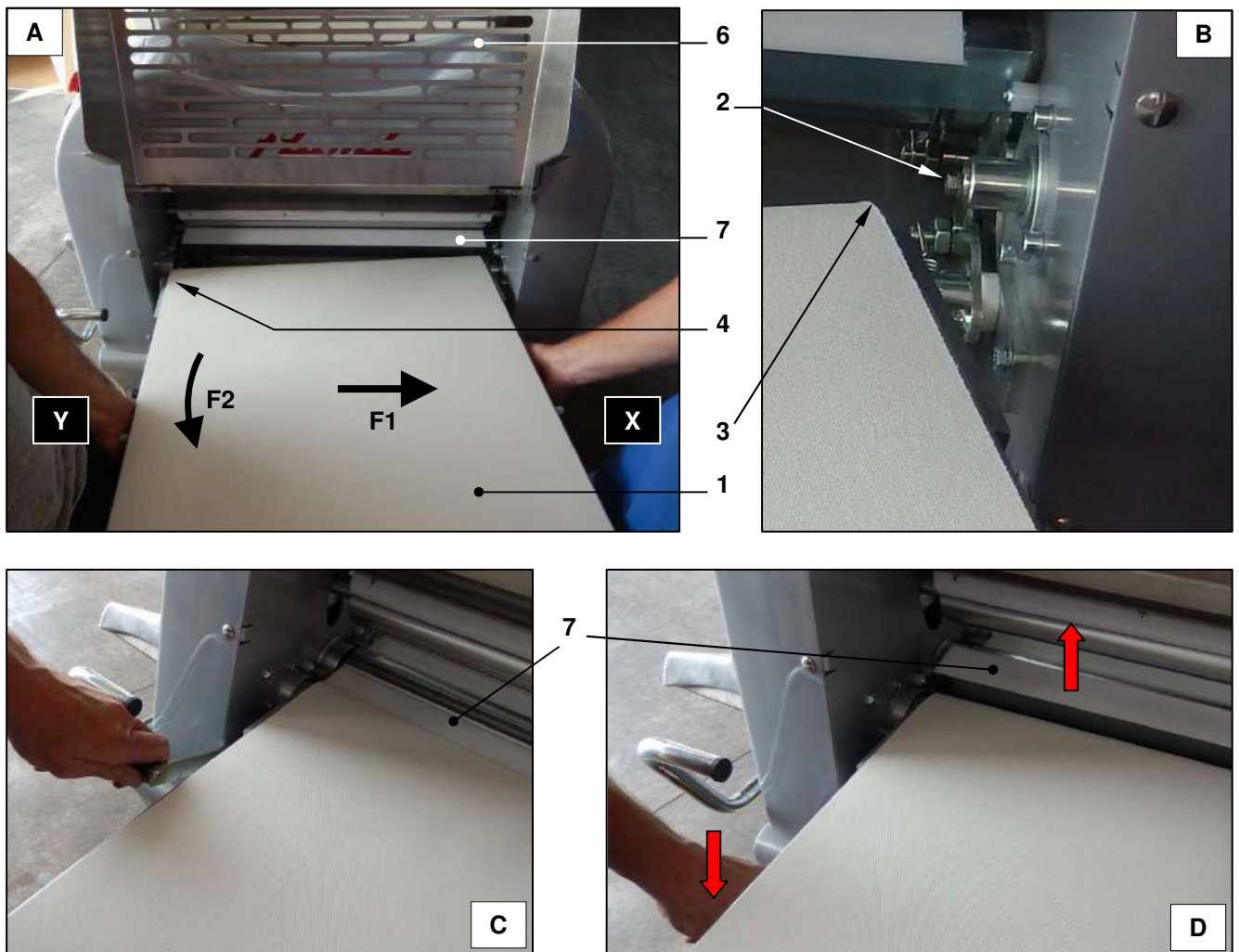

Figure 13 - Removing the benches (SF600 only)

3.5 LIFTING AND LOWERING THE INTERLOCKED GUARDS

The guards need to be opened in order to:

- clean the rollers and the innermost part of the conveyor belts (section. 4.10)
- remove and install the scrapers (section 4.5)
- place the benches in the raised position (section 3.6)
- carry out specific maintenance work, for example changing the conveyor belts (section 4.6)

When a guard is raised, the safety system stops all moving parts, or prevents any part of the machine from starting and disconnects power to the actuators (e.g. motor).

The methods for lifting and securing the guard in the raised position and to release and lower it afterwards, are different for models SF450 (section 3.5.1) and models SF 500 and SF600 (section 3.5.2).

3.5.1 MOD. SF450

With reference to Figure 14, the guards, when lowered, appear as in photo A. To lock them in the upright position:

- lift the guard approximately half way and then push it towards the controls side of the machine (photo B)
- while keeping it pushed sideways, lift the guard completely (photo C)
- while keeping it raised, stop pushing it sideways: it will remain in the raised position (photo D).

To lower a guard that is raised and locked in position, simply push it sideways towards the controls side: then keep pressing it sideways and lower it until it reaches the position shown in photo A.

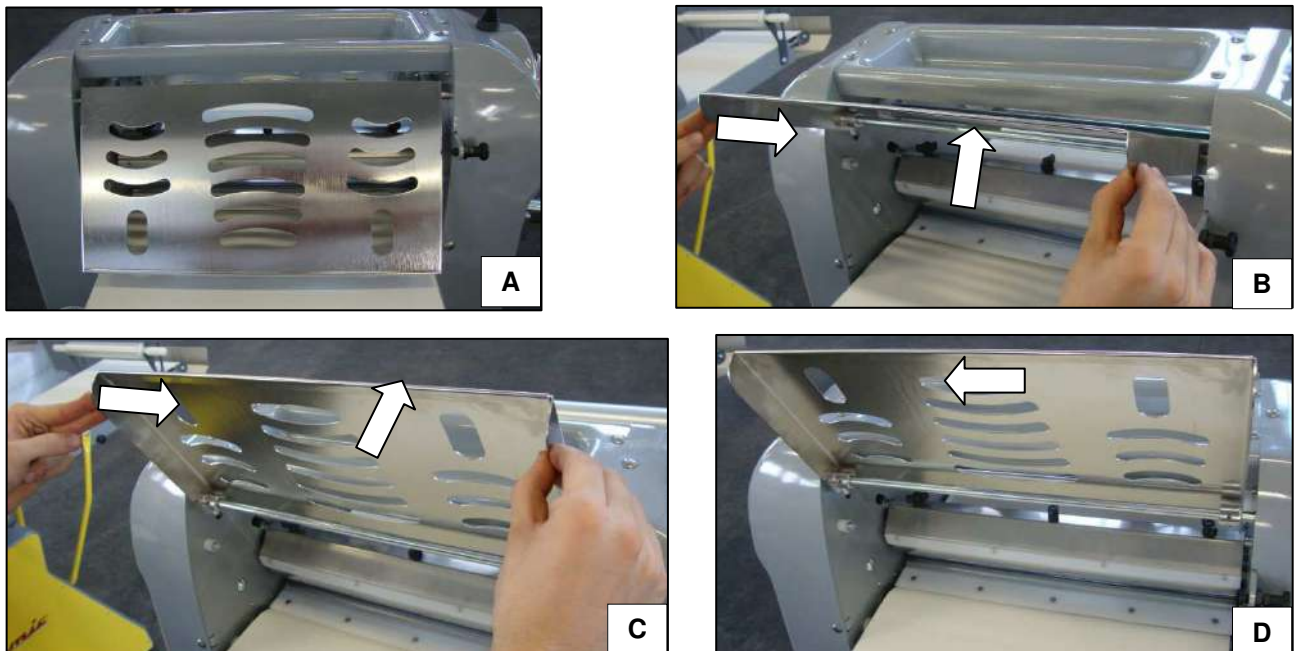

Figure 14 - Raising/lowering the interlocked guards (mod. SF450)

3.5.2 MOD. SF500 AND SF600

With reference to Figure 15, the guards, when lowered, appear as in photo A.

When raised completely, they remain locked in the raised position (photo B).

To lower them, simply push them sideways towards the side opposite the controls side and lower them (photo C) until they reach the position shown in photo A.

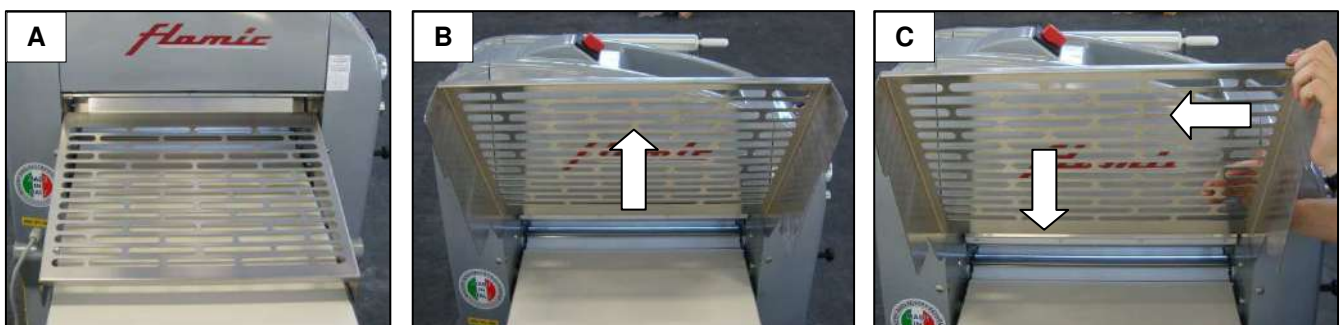

Figure 15 - Raising/lowering the interlocked guards (mod. SF500 - SF600)

3.6 PLACING THE BENCHES IN THE WORK POSITION OR RAISING THEM WHEN NOT IN USE

Wear clean work gloves and footwear with reinforced toecaps.

This can be carried out by one operator only on machines with benches of up to 850 mm long max. For other benches, two people are required in order to avoid being exposed to the risk of musculoskeletal injuries.

3.6.1 MOD. SF450

With reference to Figure 16, to move a bench ref. 1 from the position shown in photo A to the position shown in photo E:

- remove any rolling pins ref. 2 there may be and lower the relative supports ref. 3
- make sure that the catch pan is completely retracted (section 3.9)
- raise the guard ref. 4 completely (see section 3.5.1)
- raise the bench ref.1 keeping the pawl ref. 5 pulled out and move the guard ref. 4 (photo B - C) as far back as possible.
- insert the pawl ref. 5 into the corresponding hole in the side of the bench (photo D).

WARNING! Make sure that the pawl ref. 5 is properly seated in order to prevent the bench from falling unexpectedly, which could hit an exposed person and cause severe bruising.

The bench is now locked in the raised position (photo E).

In order to move a bench from the position shown in photo E into its work position shown in photo A, pull out the pawl ref. 5 and lower the bench until it is in the correct down position.

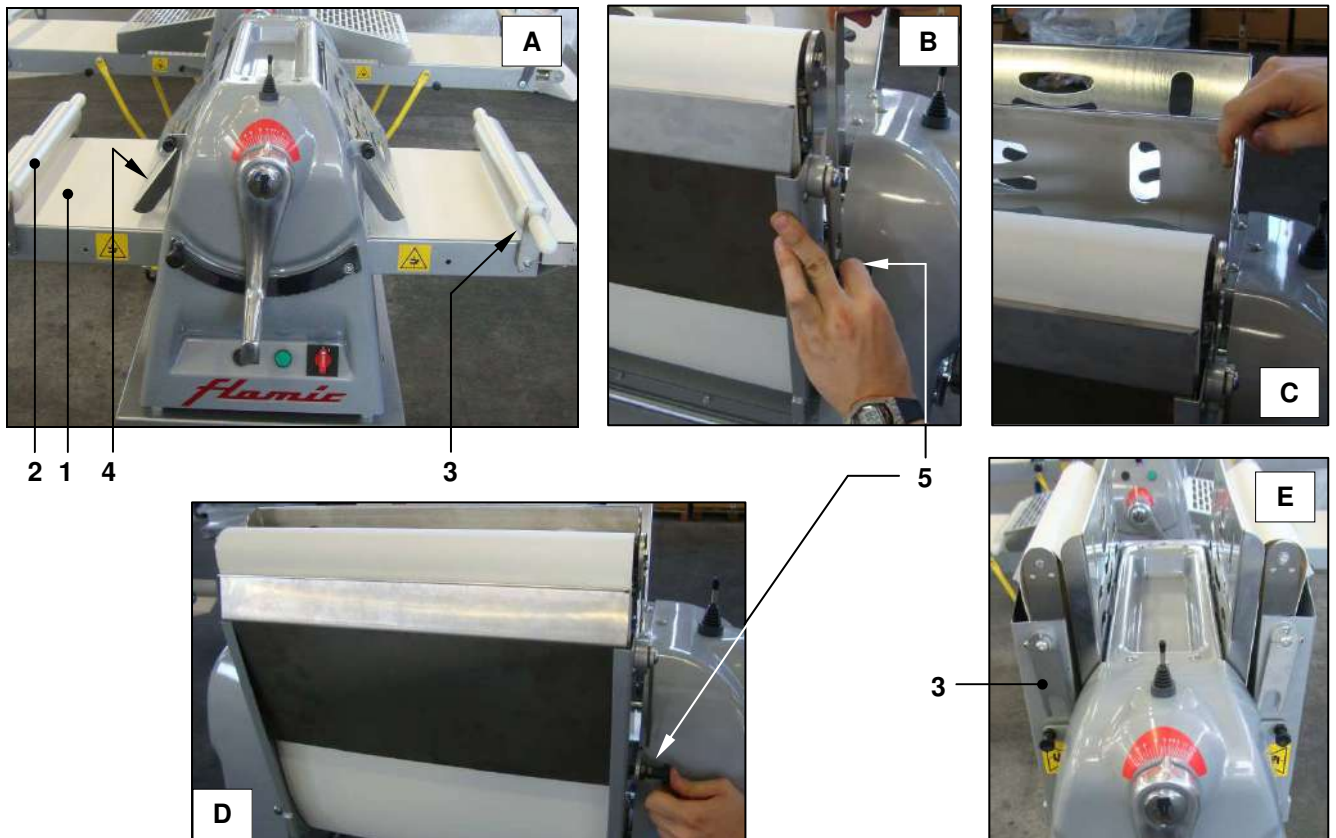

Figure 16 - Raising/lowering the benches (mod. SF450)

3.6.2 MOD. SF500

With reference to Figure 17, to move a bench ref. 1 from the position shown in photo A to the position shown in photo C or F:

- remove any rolling pins ref. 2 there may be and lower the relative supports ref. 3
- make sure that the residue collection tray is fitted and secured in place (see section 3.8) and that the catch pan is retracted (section 3.9)
- raise the guard ref. 4 completely (see section 3.5.1)
- raise the bench ref. 1 (photo B)
 - for table lengths of ≤ 850 mm: whilst keeping the table raised with one hand, with the other, place the horizontal bar of the support ref. 5 onto the blocks ref. 6 (photo C)
 - for table lengths of > 850 mm: whilst one operator keeps the table raised with both hands, the other operator should place the horizontal bar of the support ref. 5 onto the blocks ref. 6

To make the raised table more stable (strongly recommended to minimize the risk of the table falling), push the raised table further forwards (photo D) in order to engage the pawl ref. 7 in the seat ref. 8 (photo E) and make sure that it enters completely (photo F).

To move the bench ref. 1 from the position shown in photo C or D, item F, to the position shown in photo A, following the instructions provided above regarding the length of the bench, push it slightly forwards and pull the pawl ref. 7 out from its seat ref. 8 or move the support ref. 5 from the upper blocks ref. 6 and lower the table so that the bar ref. 5 of the support is resting on the lower blocks ref. 9.

In both cases, **the bar ref. 5 of the table support must be properly and well seated on the blocks ref. 6 or ref. 9 to avoid the risk of the table accidentally falling.**

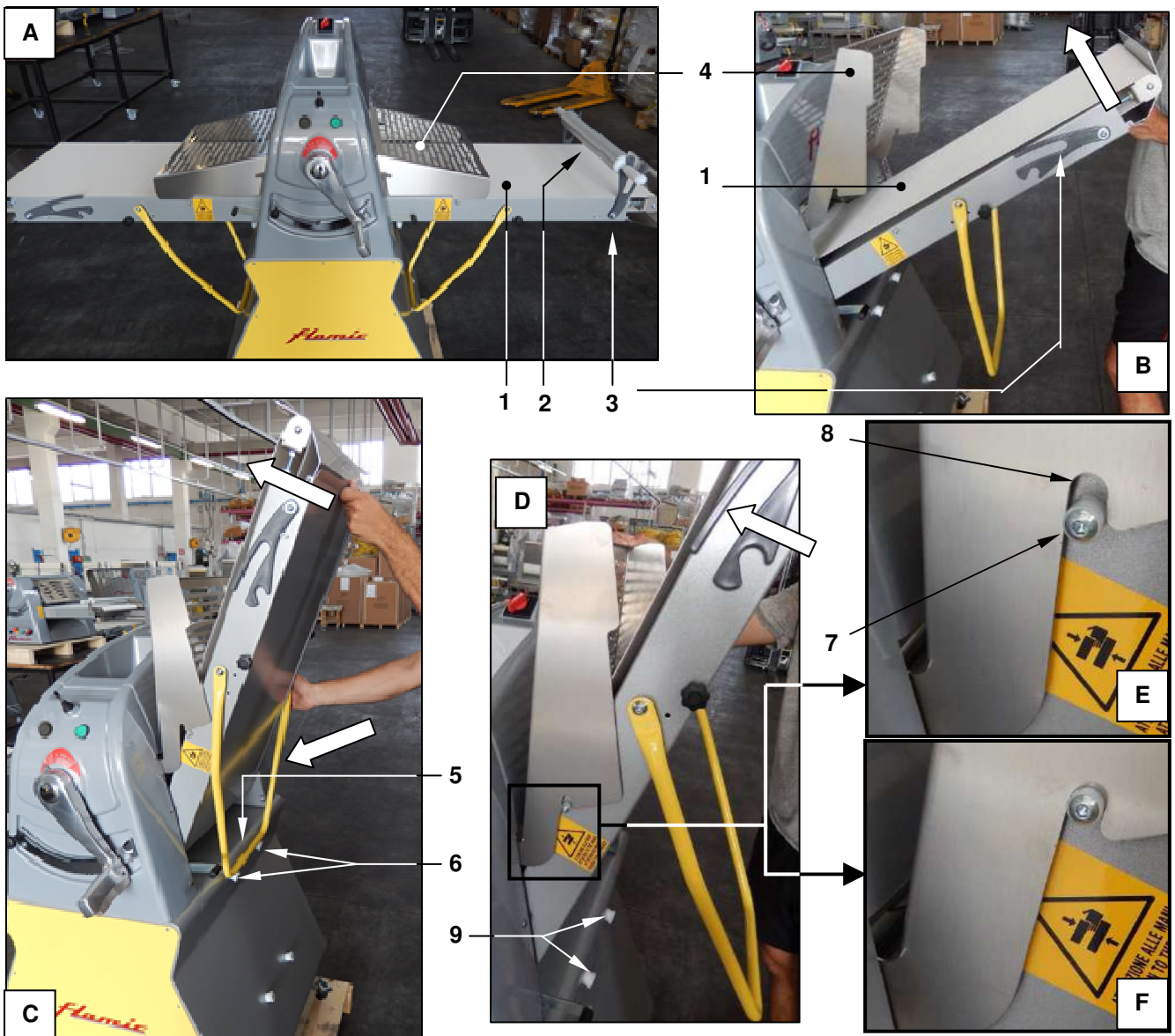

Figure 17 - Raising/lowering the benches (mod. SF500)

3.6.3 MOD. SF600

With reference to Figure 18, to move a bench ref. 1 from the position shown in photo A to the position shown in photo E:

- remove any rolling pins there may be and lower the relative supports
- make sure that the residue collection tray is fitted and secured in place (see section 3.8) and that the catch pan is retracted (section 3.9)
- raise the guard ref. 4 completely (see section 3.5.1)
- raise the table ref. 1 (photo B)
 - for table lengths of ≤ 850 mm: whilst keeping the table raised with one hand, with the other place the horizontal bar of the support ref. 5 onto the blocks ref. 3 (photos C - D - E)
 - for table lengths of > 850 mm: whilst one operator keeps the table raised with both hands, the other operator should place the horizontal bar of the support ref. 5 onto the blocks ref. 3

To move the bench ref. 1 from the position shown in photo E to the position shown in photo A, following the instructions provided above regarding the length of the bench, push it slightly forwards and move the support ref. 5 from the upper blocks ref. 3 and lower the table so that the bar ref. 5 rests on the lower blocks ref. 2.

In both cases, **the bar ref. 5 of the table support must be properly and well seated on the blocks ref. 2 or ref. 3 to avoid the risk of the table accidentally falling.**

Remember that only tables up to 1400 mm long can only be folded as in photo E. Longer tables have to remain in the work position as shown in photo A.

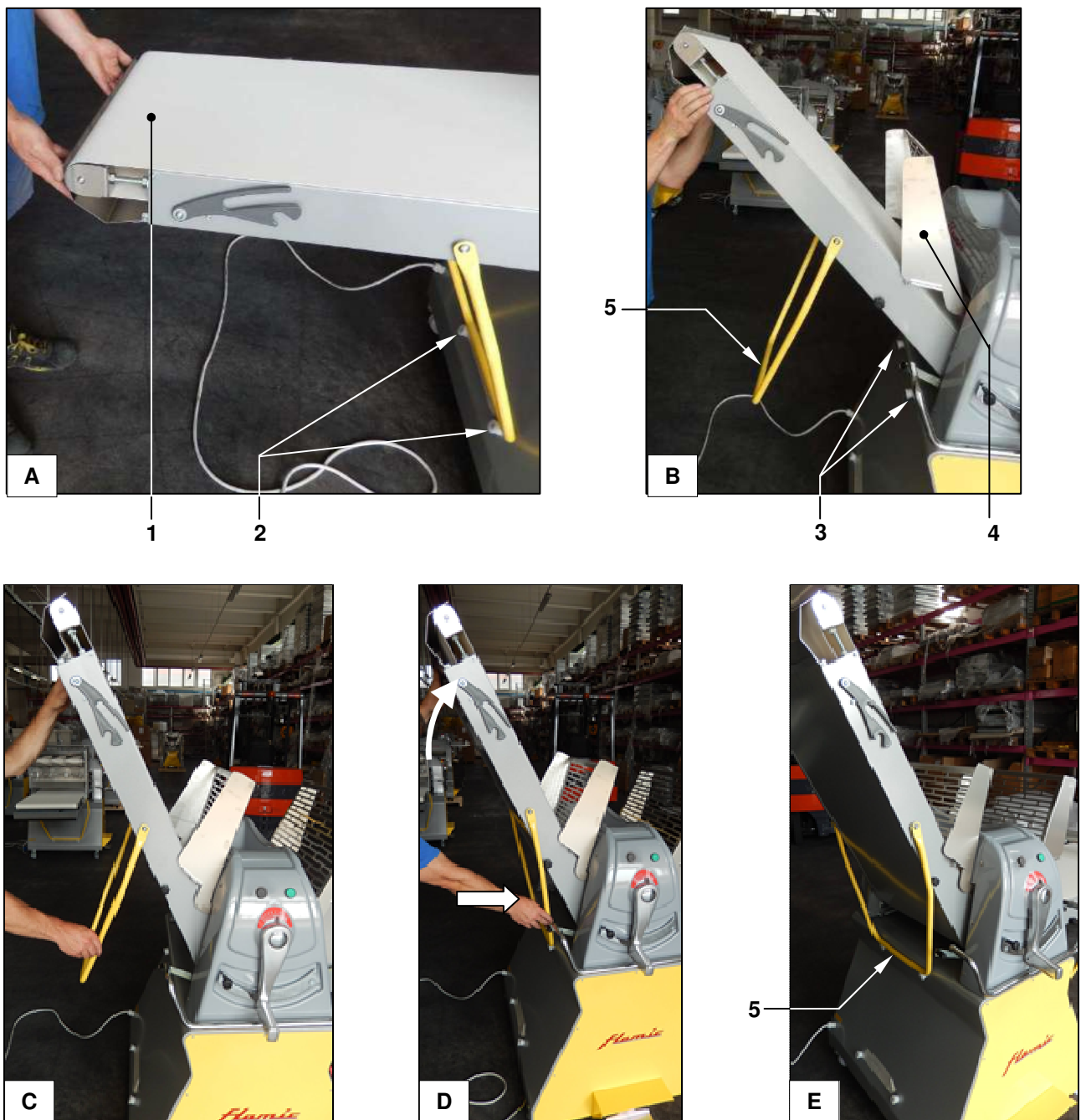

Figure 18 - Raising/lowering the benches (mod. SF600)

3.7 MOD. SF450B: POSITIONING AND FASTENING THE MACHINE ON THE TROLLEY (OPTIONAL)

Wear safety footwear with reinforced toecaps, abrasion resistant work gloves and a hard hat.

Lift the machine as described in section 3.2. Then, with reference to Figure 19:

- make sure that the wheels of the trolley have been locked using the brake levers
- position the support spacers ref. 2 onto the surface of the trolley ref. 4 (one spacer for each corner) and insert the screws ref. 3 into the central hole from underneath.
- lower the machine until you are able to screw the screws ref. 3 into the corresponding threaded holes in the base of the machine, one at a time, but without tightening them.
- once the four screws ref. 3 have been screwed in, lower the machine and rest it on the spacers ref. 2
- tighten the screws ref. 3 gradually and alternately until the machine is secured to the trolley. Then tighten the screws securely but do not over tighten them so as not to damage the parts.

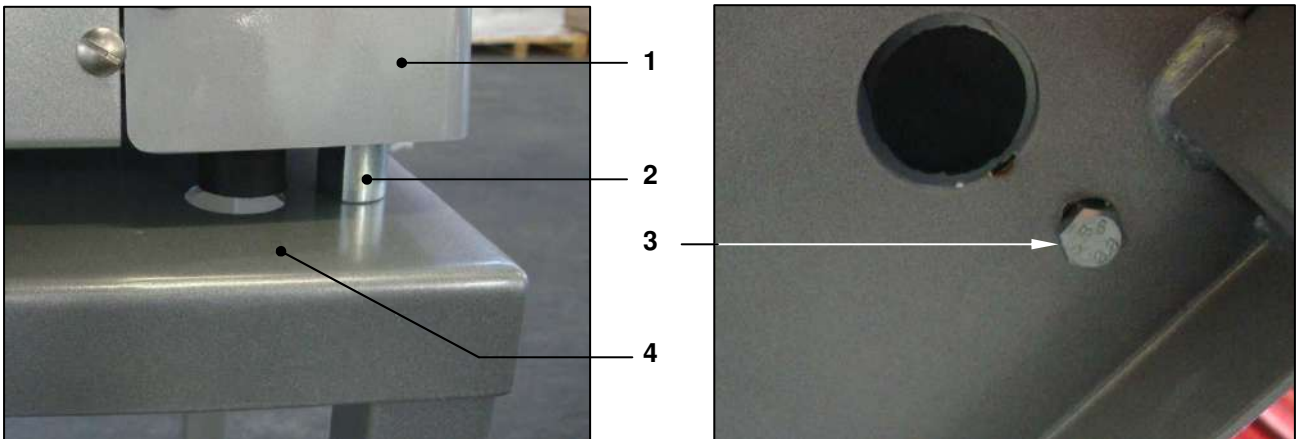

Figure 19 - Fastening the sheeting machine mod. SF450 to the carriage (optional)

3.8 UNDER-TABLE AND CENTRAL DUST AND RESIDUE COLLECTION TRAY(S)

With reference to Figure 20, there is a tray ref. 1 under each bench to collect dust and dough residues. It can be removed after having removed the threaded knobs ref. 2 (except model SF450 in which the dust and residue collection tray is integral with the catch pan), one on each side of the bench (photos A - B). When inserting the residue collection tray, fasten it in position using the threaded knobs ref. 2 (except for model SF450). For models SF500 and SF600 a tray is also provided ref. 3 to place under the rolling zone (photos C - D).

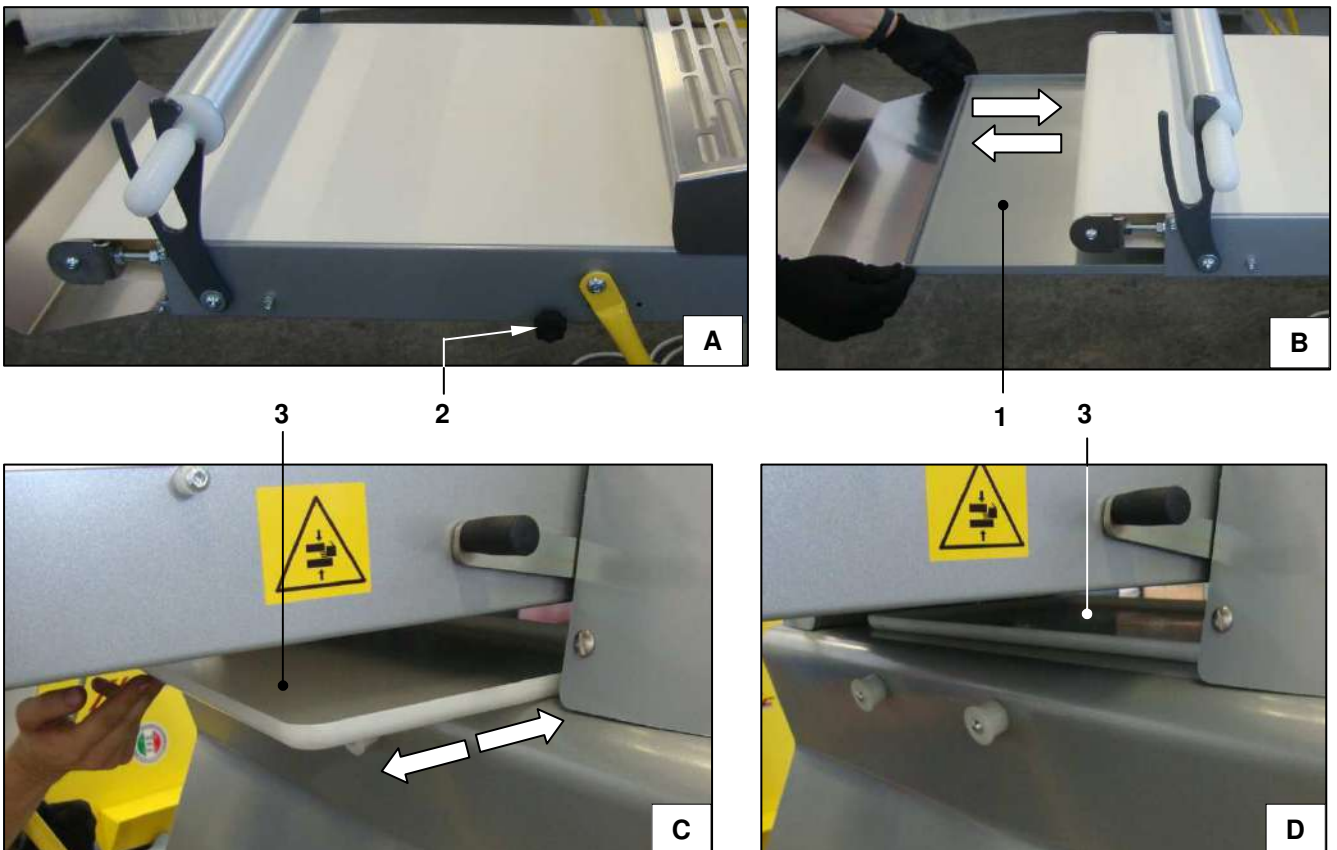

Figure 20 - Under-table and central (only SF500 and SF600) residue collection trays

3.9 CATCH PANS FOR COLLECTING THE DOUGH SHEET THAT IS TOO LONG FOR THE CONVEYORS

There is a catch pan at the end of each table to collect the rolled dough, which because of its excessive length, would otherwise fall onto the floor. It can be pulled out from under the table by simply pulling it and be retracted by pushing it.

On model SF450 the residue collection tray and the catch pan are a single unit.

Figure 21 shows a fully extended and fully retracted catch pan ref. 1 for each model of dough sheeter.

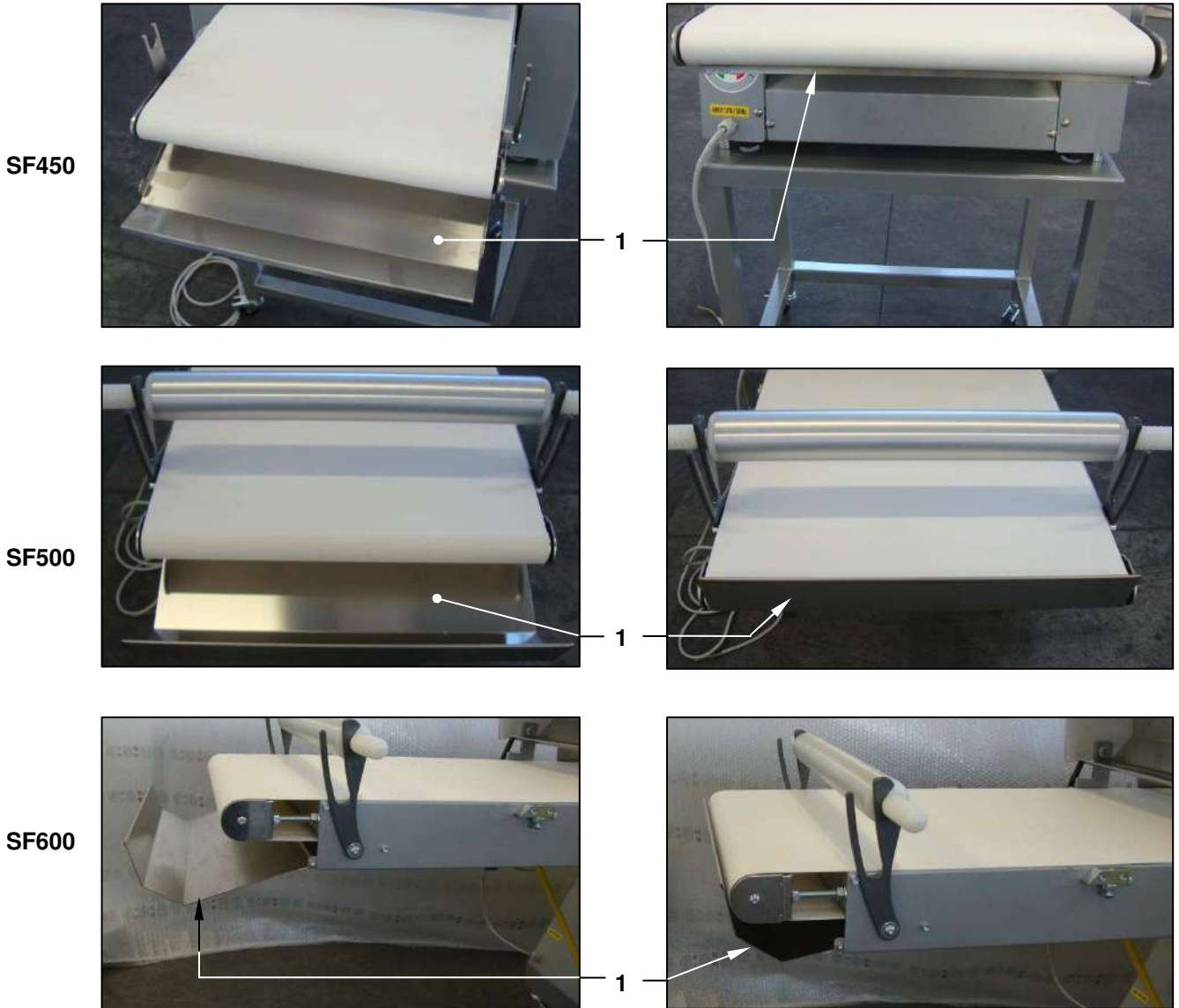

Figure 21 - Catch pan

3.10 CUTTING UNIT (only for SF600V with bench lengths of 1400 mm or greater)

With reference to Figure 22, both sides of the benches designed to be used with the cutting unit ref. 1 are fitted with the following devices (photo A - B):

- blocks ref. 7 with threaded knob ref. 2, in which to insert the side plates of the cutting unit,
- positioning plates ref.9 for engaging and holding the cutting unit against the table.

3.10.1 INSTALLING AND POSITIONING THE CUTTING UNIT

This must be carried out with the machine switched off and with the main power switch in the O - OFF position.

With reference to Figure 22, to install the cutting unit ref. 1 proceed as follows:

- **wear safety footwear with reinforced toecaps and abrasion resistant gloves**
- unscrew and completely remove the knobs with threaded studs ref. 2
- even if the weight is not particularly high (max. 23 kg), **the following must be carried out by two people in order to minimize the risk of musculoskeletal injuries** and ergonomic injuries in general. In order to reduce the weight to be lifted as much as possible, remove the cutting rollers ref. 3 and ref. 4 (the weight is reduced to approximately 15 kg). This is particularly important where it is not possible to have the assistance of a second person. Raise the unit ref. 1 and place it like a bridge over the bench as shown in photos A - C. Then insert the plates ref. 5 into the seats ref. 6 in the blocks ref. 7 at the sides of the bench and lower the unit under its own weight as far as it will go (photo C).
- after having placed the studs of the knobs into the through hole ref. 10 in the blocks ref. 7, screw the knobs ref. 2 as far as they will go into the lateral threaded holes of the plates ref. 5 (photo B), but without tightening them excessively.
- when reinstalling the rollers, remember that the cutting roller ref. 3 must be positioned on the side from which the dough arrives, i.e. usually on the side of the thickening rollers (for removing and installing the cutting rollers see section. 3.10.4).
- lower the unit onto the bench, guiding it by hand (photo D). When it stops (photo E), push it firmly downwards until you hear a loud metallic click. This indicates that the hook ref. 8 has engaged with the positioning plate ref. 9 (photo F) and that the unit is secured to the bench, as shown in photo G (make sure that it has been properly engaged on both sides).

In this configuration, the maximum thickness of the dough that can pass under the cutting unit is 7 mm.

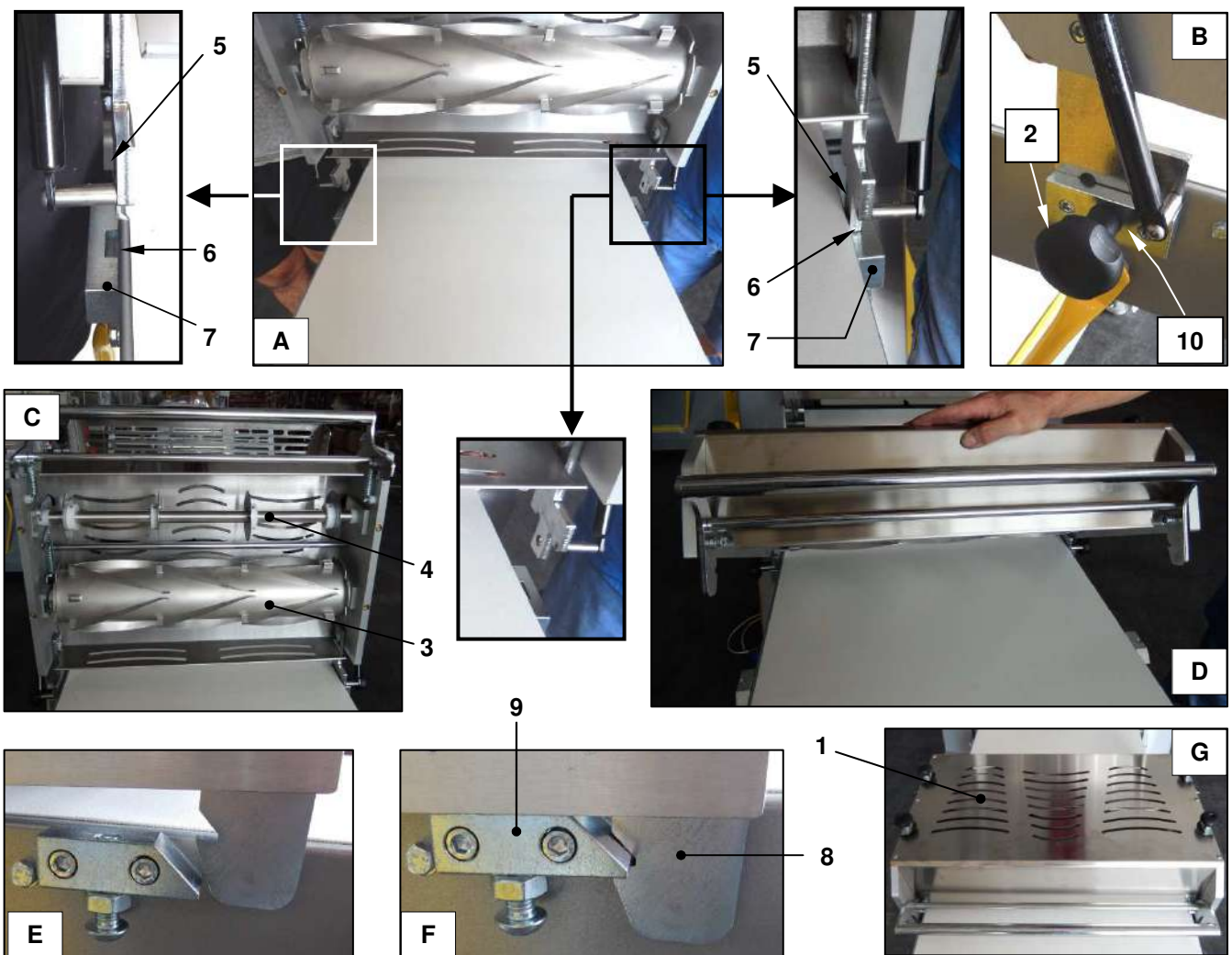

Figure 22 - Installing the cutting unit

3.10.2 DISABLING THE CUTTING UNIT

With reference to Figure 23, to use the machine as a sheeter whilst keeping the cutting unit mounted, simply release the cutting unit from the system that secures it to the table by lifting the release bar ref. 1 (to make this easier, push the unit down with one hand).

WARNING! To prevent the unit from being raised too quickly (pushed by the lateral gas springs ref. 2) **and risk being hit and bruised by it, guide it by hand as it is raised. In the event that the gas springs may be discharged, place the unit well back to prevent it from falling and subject persons to the risk of severe bruises and cuts and bruises.** If you notice that one or both gas springs no longer provide an adequate braking function, replace it/them immediately (simply remove the two screws ref. 3 at the ends). Only use original Flamic spare parts.

The maximum thickness of dough that can pass under the cutting unit is 55 mm.

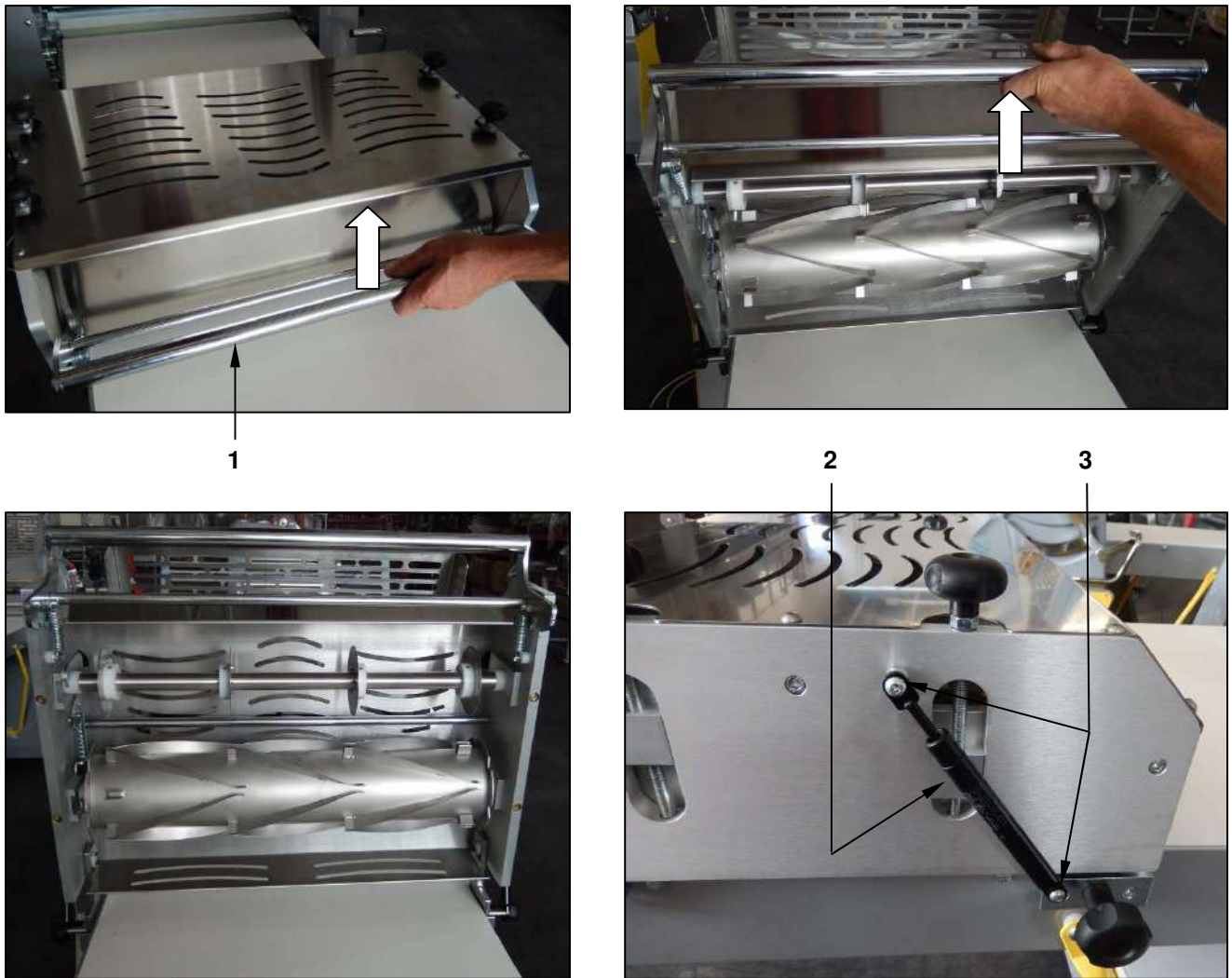

Figure 23 - Disabling the cutting unit

3.10.3 ADJUSTING THE FORCE EXERTED ON THE BENCH BY THE CUTTING ROLLERS

With reference to Figure 24, to adjust the force exerted on the table by the cutting rollers:

- turn the knobs ref. 1 to adjust the roller fitted with the longitudinal cutting discs ref. 4
- turn the knobs ref. 2 to adjust the cutting roller ref. 3

Turn the knobs clockwise (as viewed from above) to increase the force and anticlockwise to decrease it.

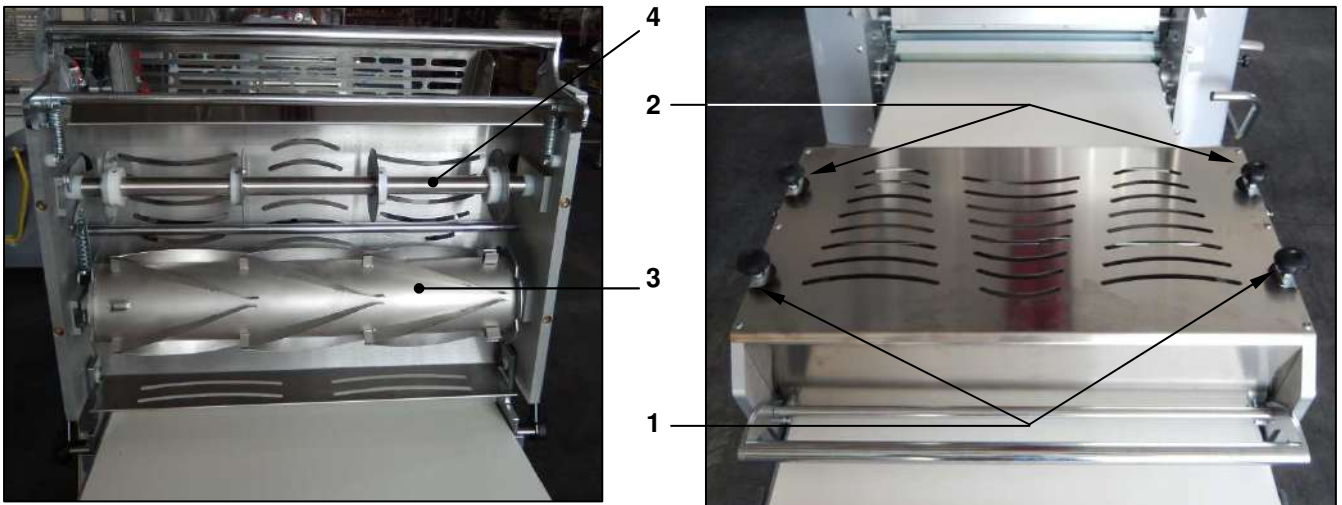

Figure 24 - Adjusting the force exerted on the bench by the cutting rollers

3.10.4 REMOVING / INSTALLING THE CUTTING ROLLERS

This must be carried out with the machine switched off and with the main power switch in the O - OFF position. Wear safety footwear with reinforced toecaps and abrasion resistant gloves.

With reference to Figure 25, place the unit in the raised position, as explained in section 3.10.2, then

- **to remove a cutting roller** ref. 1, using one hand, support it roughly in the centre and with the other hand move the lever ref. 2 to raise and open the seat ref. 3. Remove the roller from the guide ref. 4 and the seat ref. 5 on the opposite side.
- **to install a cutting roller** ref. 1, first insert the end into the seat ref. 5, then open the seat ref. 3 by moving the lever ref. 2. Insert the other end of the roller in to the guide ref. 4 and push it in as far as it will go and then release the lever ref. 2.

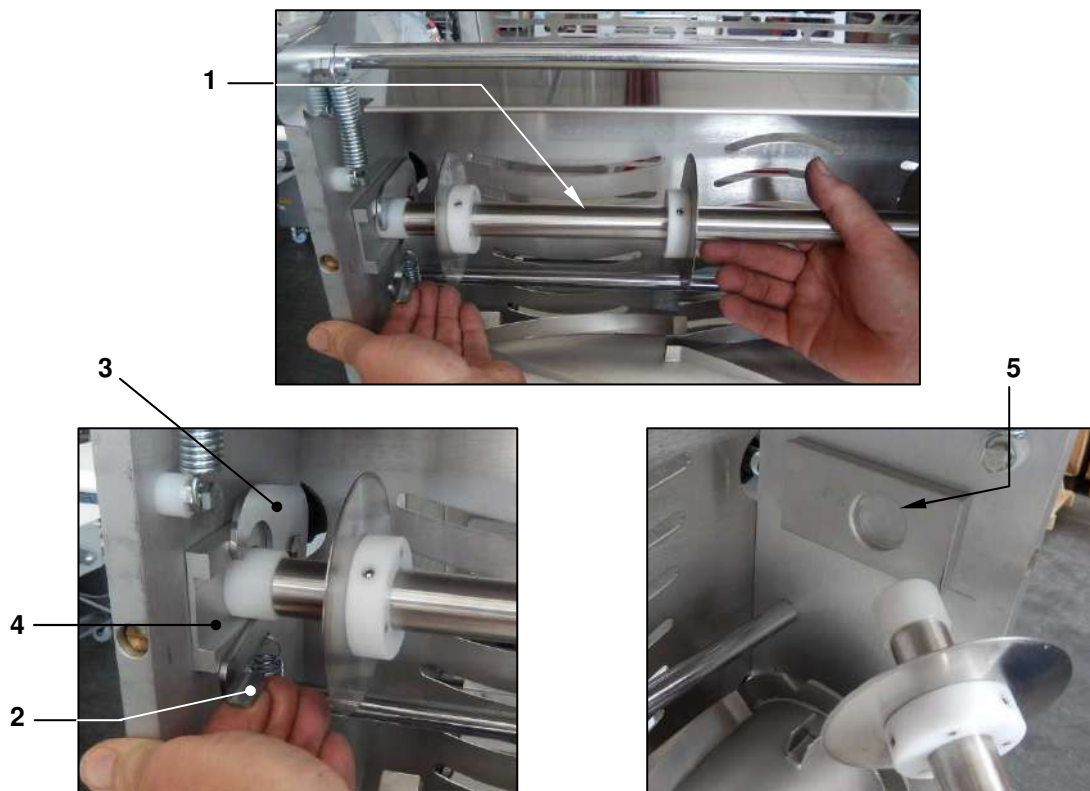

Figure 25 - Removing/installing the cutting rollers

3.10.5 REMOVING THE CUTTING UNIT

This must be carried out with the machine switched off and the main power switch in the O - OFF position.

With reference to Figure 26, to remove the cutting unit, proceed as follows:

- **wear safety footwear with reinforced toecaps and abrasion resistant gloves**
- release the cutting unit and place it into the raised position as shown in photo A (see section 3.10.2)
- unscrew and completely remove the knobs with the threaded stud ref.1 (photo B)
- even if the weight to be handled is not particularly high (max. 23 kg), **the following task must be carried out by two people** for the same reasons as indicated in section 3.10.1. Before starting, remove the cutting rollers (see section 3.10.4) in order to reduce the weight to be handled as much as possible (to about 15 kg). This is particularly important if it is not possible to be assisted by a second person.
- lift the unit, keeping it parallel to the surface of the bench until the plates ref. 2 (photo C) have been completely removed.
- place the unit in a safe place and take precautions to prevent it from tipping over, falling or being damaged.
- screw the threaded studs of the knobs ref. 1 into the relative threaded holes to avoid losing them.

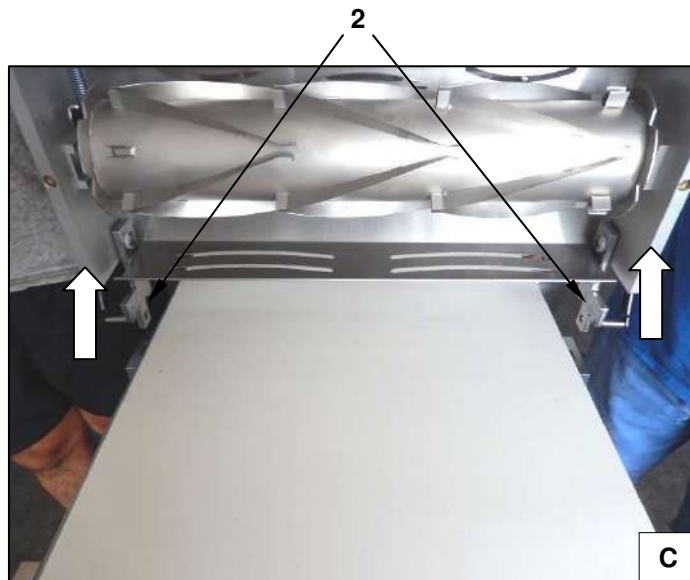
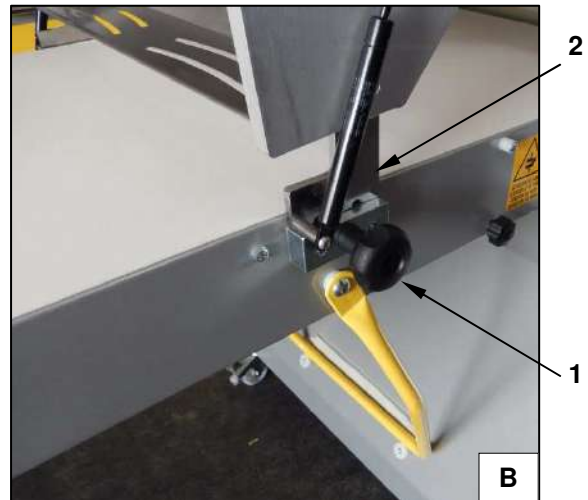

Figure 26 - Removing the cutting unit

3.11 OPERATION AND USE

The machine should only be used by authorized personnel that are experienced in the use of pastry making and/or bakery machinery and **that have been properly trained and informed about the residual risks involved and the measures that have been taken to eliminate or reduce them further.**

The machine has been designed for professional use and by one operator at a time. It is not allowed for more than one operator to work on/with the machine at the same time, unless where otherwise indicated in this manual. The instructions given in this manual are adequate and appropriate. However, upon request and with prior agreement, Flamic can provide information and training on the proper and safe use of the machine either at its own premises or at the customer's premises.

It is forbidden for anyone who does not have the specified requisites to work on/with the machine

It is the responsibility of the user to identify the personnel that are suitable to use the machine and to authorize them to do so. In accordance with current laws regarding health and safety in the workplace, the employer must provide adequate **information, training and practical training** for the personnel authorized to use the machine. He must also **implement appropriate operating procedures** in order to minimize as much as possible, exposure to residual risks associated with using the machine (see section 5.2). The manufacturer accepts no liability, direct or indirect, for injury or damage to persons, animals or property caused by the failure to comply with what is written in this manual.

3.11.1 GENERAL INFORMATION FOR USE

Before starting to work, remember:

1. To carry out the checks described in section 5.2.3 **at the start of each working day and/or shift.**
2. That the entire batch of dough to be rolled must be malleable at room temperature. **It is strictly prohibited to roll blocks of dough that are not malleable** (for example if very cold or frozen).
3. **Before rolling, the thickness of the dough must be less than 35mm for the SF450 model and 56 mm for the SF500 and SF600** so that it doesn't touch the interlocked guards. The amount of dough that can be processed must be within the limits specified in section 2.6.
4. Do not place more than the maximum permissible amount of dough that can be processed by the machine at a time (see section. 2.6)
5. **Do not use the tables as surfaces on which to work the dough by hand or with tools and/or methods not intended by Flamic.** In particular, do not place batches of dough onto the tables and beat them using rolling pins or other tools to reduce their thickness. The table and relative supports are not designed to withstand forces other than the weight of the tables, the dough to be rolled and the cutting unit, if installed. In the event of a mechanical failure, **there is a risk of causing serious damage to the machine and injury to persons.**
6. **Avoid handling heavy or large quantities of dough by hand to avoid ergonomic hazards** and possible musculoskeletal injuries.
7. If you have to dust the dough with flour, **do not throw it onto the dough**, but simply let it fall on several areas of the dough so as to limit the dispersion of dust into the air.
8. No particular PPE is required when using the machine under normal circumstances except for particular or specific situations that might arise from the health and safety risk assessment that must be carried out by the employer (this is a legal requirement in the EU). For example, if the operator were to disregard what is written above and spread the flour quickly and briskly by hand, it would create a large amount of dust that could cause health risks if inhaled (rhinitis, asthma etc.). In this case, it is the responsibility of the employer to take the appropriate measures to eliminate or minimize the risks of dispersed dust (for example, before spreading the flour, to make sure that no one is nearby, to wear a dust mask with a filtering capacity that is appropriate for the particle size of the flour, indicated in the data sheet if available, or to be measured by the employer).
It is the responsibility of the employer to identify any other PPE that should be worn (e.g. food hygiene PPE, or that which is indicated in the safety data sheets for specific products used).
9. Set the rolling thickness to slightly less than the thickness of the dough to be rolled, in order to prevent the dough from "tearing". This becomes more important the thinner the dough to be rolled.
10. With the cutting unit installed and ready for use (lowered and locked in position) the maximum thickness of the dough sheet that can pass underneath it is 7 mm. With the unit raised the gap is 55 mm.
11. Do not recover the flour that has been deposited on parts of the machine. It may be contaminated and affect the purity and hygiene of the dough and cause a risk to consumers.
12. **Do not try to reach the rollers from under the guards or from under the tables.** There is no reason to do so and you would be unnecessarily exposed to serious safety risks (section 5.2.4.1). To remove residues from between the scrapers and rollers or to clean the rollers in safety, stop the machine and raise the guards.
13. Under normal circumstances **do not raise the guards to stop the machine** so as not to expose yourself to unnecessary risks (the rollers and belts continue to move for a maximum of one second before stopping, see section 5.2.4.1) or cause excessive wear on the safety system. You should use STOP button ref. 3 Figure 4.

3.11.2 SWITCHING THE MACHINE ON AND OFF

To switch on the machine, place the power plug into a suitable electrical outlet and turn the main switch ref. 1 Figure 4 to **I – ON**. To switch it off, turn the main power switch ref. 1 Figure 4 to **O – OFF**.

3.11.3 PREPARING THE MACHINE

- Check that the wheels (if present) are locked by the brake levers (see section 3.2).
- Place the benches in the horizontal work position (see section 3.6).
- Lower the guards completely (see section 3.5).
- Fill the tray ref. 5 Figure 1 with the amount of flour that is strictly necessary.
- Check that the residue collection trays have been installed and fixed in place and (only for models SF500 and SF600) that the central residue collection tray has been properly positioned under the rolling zone (see section 3.8)
- If necessary, remove the catch pan (see section 3.9)
- Switch on the machine (see section 3.11.2)
- Keep the rolling pin ready to wind the dough that is produced or to unwind the dough from which to obtain the dough shapes.

3.11.4 USING THE MACHINE AS A SHEETER

1. Place the batch of dough on one of the tables. The thickness and quantity must be within the limits indicated in this manual (section 2.6 and section 3.11.1, point 3). Do not work the dough on the tables, either with bare hands or by other means (e.g. beating it with a rolling pin): the benches are not designed to withstand excessive forces and/or shocks.

The temperature of the dough to be rolled must be approximately the same as that of the working environment. The entire batch of dough must be easily malleable. **It is strictly prohibited to roll blocks of dough that are not malleable**, for example if very cold or frozen.

The manufacturer will not under any circumstances be held liable for damage caused by the failure to comply with the instructions provided in this manual.

2. Switch on the machine (see section 3.11.2) and press the enable/start push-button ref. 2 Figure 4
3. Pass the dough between the rollers in alternate directions (section 2.4) adjusting the rolling thickness (section 2.5).
4. If you need to sprinkle flour onto the dough, take the precautions referred to in section 3.11.1, point 7 and, if applicable, point 8.
5. **Avoid handling heavy or large quantities of dough by hand that are difficult to support to avoid ergonomic hazards and possible musculoskeletal injuries** (the lower the weight to be lifted and/or the easier it is to support, the lower the risk).
6. If a guard is raised, the machine stops. To resume processing, lower the guard, press the enable button ref. 2 Figure 4. Then activate the start and reverse controls described in section 2.4.
7. If the STOP button, ref. 3 Figure 4 is pressed, the machine stops. To resume processing, press the enable button ref. 2 Figure 4 and then activate the start and reverse controls described in section 2.4.
8. With reference to Figure 27, before the last pass between the rollers, raise the supports ref. 1 (photo B) of the rolling pin ref. 2. Place a rolling pin in the deepest slot (photo C) and wrap a small section of rolled dough around it. The rolling pin will continue to turn because of friction against the belt and wind the entire sheet of dough.
9. Once the entire sheet of dough has been wound, move the rolling pin to the upper slot (photo D) or remove it from the machine.
10. Before restarting to roll dough, remove the rolling pins (which are either empty or full) from the machine and lower the supports ref. 1 (photo A).

When you have finished using the machine, switch it off (turn the switch ref. 1 Figure 4 to **O – OFF** and clean it (section 4.10).

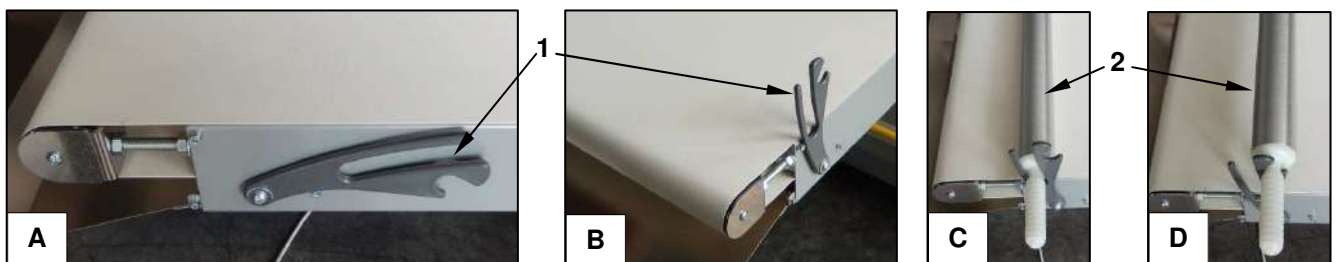

Figure 27 - Rolling pin and relative supports

3.11.5 USING THE MACHINE FOR PRODUCING DOUGH SHAPES FROM THE ROLLED SHEET

1. Install the cutting unit on the machine (section 3.10.1)
 2. Install the cutting rollers required for the product you wish to obtain, if necessary (section 3.10.4)
 3. Place the cutting unit in its working position (section 3.10.1) and adjust the thickening rollers so that the gap between them is greater than the thickness of the sheet of dough. The sheet of dough should not be more than 7 mm thick.
 4. Place the rolling pin with the dough wrapped around it in the lowest slot of the support on the opposite bench (section 3.11.4)
 5. Unroll a small amount of dough by hand
 6. Start the machine so that the dough unrolls underneath the rolling pin, passes through the rollers and reaches the cutting unit (you should obviously not reverse the direction of the belts)
 7. If necessary, adjust the force that the cutting rolls exert on the bench (3.10.3)
 8. Collect the pieces that are output from the cutting unit and separate them from the waste, which unless it is contaminated can be reused to make another sheet of dough of the same type.
- When you have finished using the cutting unit, remove it from the machine (section 3.10.5) and clean it (section 4.10).

3.12 PUTTING THE MACHINE TEMPORARILY OUT OF SERVICE AND STORING IT

When you do not expect to use the machine for a long time:

- clean it thoroughly (section 4.10)
- take it (**leaving the tables lowered**) to the position in which you wish to store it
- for the machines in which the tables are designed to be folded (Belt length ≤ 1400 mm), and only if necessary to do so, fold the tables into a secure upright position as shown in Figure 28, by following the instructions in section 3.6.



Figure 28 - Machine with benches raised

3.13 TRAINING OF PERSONNEL ASSIGNED TO THE MACHINE

As already stated several times in this manual, the employer must provide employees with adequate information and training, including practical training, regarding the proper and safe use of the machine (it must be simple and understandable according to the perspicacity that can reasonably be expected from those involved).

The following table provides a minimum list of topics that must be covered in terms of information, training and practical training. For greater clarity we have provided the following definitions:

- information:** the transfer of information, knowledge etc. without verifying that it has been learnt
- training:** the transfer of information, knowledge etc. on specific topics and verifying that the topics covered were understood but without practical tests
- practical training:** the transfer of information, knowledge etc. with a practical demonstration of the application of the topics and specific subjects and verifying that the topics covered were understood through their practical application.

Subject	Information	Training	Practical training	Chapter / Section
Machine hazards and relative risks	X			5.2
Limitations to use and the intended use of the machine. Permitted and non-permitted uses	X			2.1, 2.6, 3.11
Handling the machine	X		X	3.2
Assembly and installation		X	X	3 - 4
Using the controls		X	X	2.4, 2.5, 3.11
Possible faults and relative solutions.	X			4.11
How to load the dough			X	3.11.1
Cleaning and maintenance	X	X	X	4
The use of PPE		X	X	3, 4, 5.2
Residual risks and measures to be taken to limit them	X	X		3.11, 5.2.4
Machine noise level	X			5.2.5
Risks related to ergonomics	X			3.4, 3.6, 3.10 3.11, 4, 5.2.4
Risks related to flour dust	X			3.11, 5.2.4
Safety devices check			X	5.2.3
Safety signs	X	X		5.3

All rights reserved. Reproduction in whole or in part of this manual is prohibited.

4 MAINTENANCE

4.1 FOREWORD

Unless otherwise specified, all work covered in this section can be considered ordinary maintenance. Any other type of maintenance however, is considered special/extraordinary maintenance (for definitions of ordinary and special/extraordinary maintenance see section 1.4). In case of doubt, contact Flamic s.r.l.

WARNING!

All maintenance and cleaning should only be carried out after having:

- **pressed the stop button** ref. 3 Figure 4
- **turned the main switch to O - OFF** ref. 1 Figure 4.
- **remove the power plug from the power outlet** (the disconnected plug must remain clearly visible so that anyone can check that power has been disconnected)

in order to prevent the machine or its part(s) being started and by other people.

- and (for version "V") after having waited a sufficient amount of time for the residual voltages in the inverter to have discharged (for further details see section 4.8 and section 5.2.4.7).

Whenever it is necessary to remove a guard or disable a safety device, take all the necessary precautions to prevent other people being exposed to the consequent risks (for example, delimit the work area with white-red chains and display work in progress warning signs). **All guards should be replaced and secured with all the fastenings provided and every safety device should be re-enabled** as soon as there is no longer any reason for it/them to be removed/disabled.

Anyone who fails to comply with these instructions and/or uses the machine improperly or inappropriately and causes, directly or indirectly, injury to people, animals or damage to property will have to accept full responsibility thereof.

4.2 MAINTENANCE AND PERIODIC CHECKS

Before starting, implement the safety measures set out in section 4.1.

- At the end of a shift or working day, thoroughly **clean the machine** (section 4.10)
- At the start of each working day or shift, **check the working efficiency of the guards and safety devices** by carrying out the checks described in section 5.2.3.

4.3 DRIVE BELT TENSION ADJUSTMENT AND REPLACEMENT

Before starting, implement the safety measures set out in section 4.1 and wear work gloves.

These operations are considered **extraordinary maintenance**.

Check the tension of the drive belts frequently during the first 24-48 hours of operation (running in) and afterwards, every two weeks. If you notice an uneven movement of the rollers and conveyor belts or you hear any unusual noises or "fluttering" (a sign that the belts are slipping), check and adjust if necessary.

4.3.1 GENERAL RULES FOR CHECKING THE TENSION OF A DRIVE BELT

With reference to Figure 29, in general, to check the tension of a drive belt, proceed as follows:

- a) Measure the length of the free section **D** [mm] between the pulleys P1 and P2
- b) At the centre of and perpendicular to section **D**, apply the force **T** that is required to deflect the belt by a value **A** (mm) use a millimetre scale to measure the deflection.
- c) The tension of the drive belt is correct if the force **T** applied to obtain the deflection **A** corresponds to the value that varies according to the type of belt and that is specified in the following paragraphs on a case by case basis.

Use a dynamometer or tension meter to measure the force (the latter usually also allows you to obtain the measurement of **A**), both of which are readily available commercially.

IMPORTANT! A drive belt that is too tight will wear quickly. On the other hand, if it is too slack it will not work and will not transmit motion.

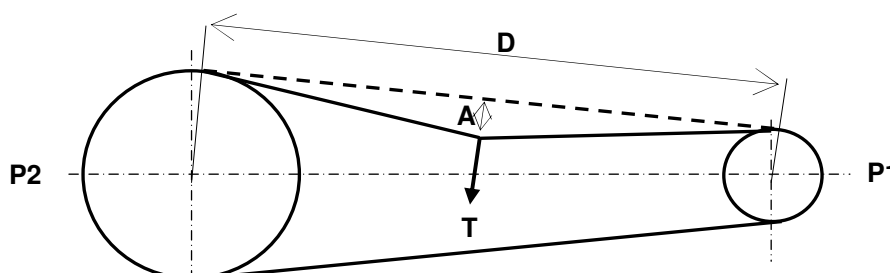

Figure 29 - Diagram showing the parameters used for tensioning a drive belt

4.3.2 SHEETER MOD. SF450

With reference to Figure 30, to adjust the tension of the drive belt ref. 5:

- remove the guard ref. 1 on the side opposite the controls. To do this you must remove the five screws ref. 2 and loosen the two screws ref. 3 just enough to remove the guard. Place the guard in safe place and in a stable position.
- using an open end spanner, turn the screw ref. 4 until the tension of the belt ref. 5 is correct. In this case consider: A = 2,1 mm T = 26,4 N (60 Hz) T=26,5 (50 Hz) (for T see section 4.3.1)
- when finished, replace the guard ref. 1 making sure that its upper edge is placed under the heads of the screws ref. 3 and then insert and tighten the screws ref. 2. Lastly, tighten the screws ref. 3 so that their heads compress the edge of the guard ref. 1.

Replacing the drive belt:

- turn the nut ref. 4 to slacken the belt ref. 5 just enough so that it can be slipped off from the pulleys P1 and P2
- install a new belt. The ridges of its inner profile must fit into the grooves on the pulley wheels P1 and P2
- adjust the tension of the drive belts(s) ref. 5 as described above. However, in this case, because the belt is new, you should consider: A = 2,1 mm T = 39 N (60 Hz) T=39,2 (50 Hz)

When done, replace the guard ref. 1 and fasten it using the screws ref. 2 and ref. 3 as described above. Use only original Flamic belts: flat belt Poly-V type, Flamic code: C114072328512

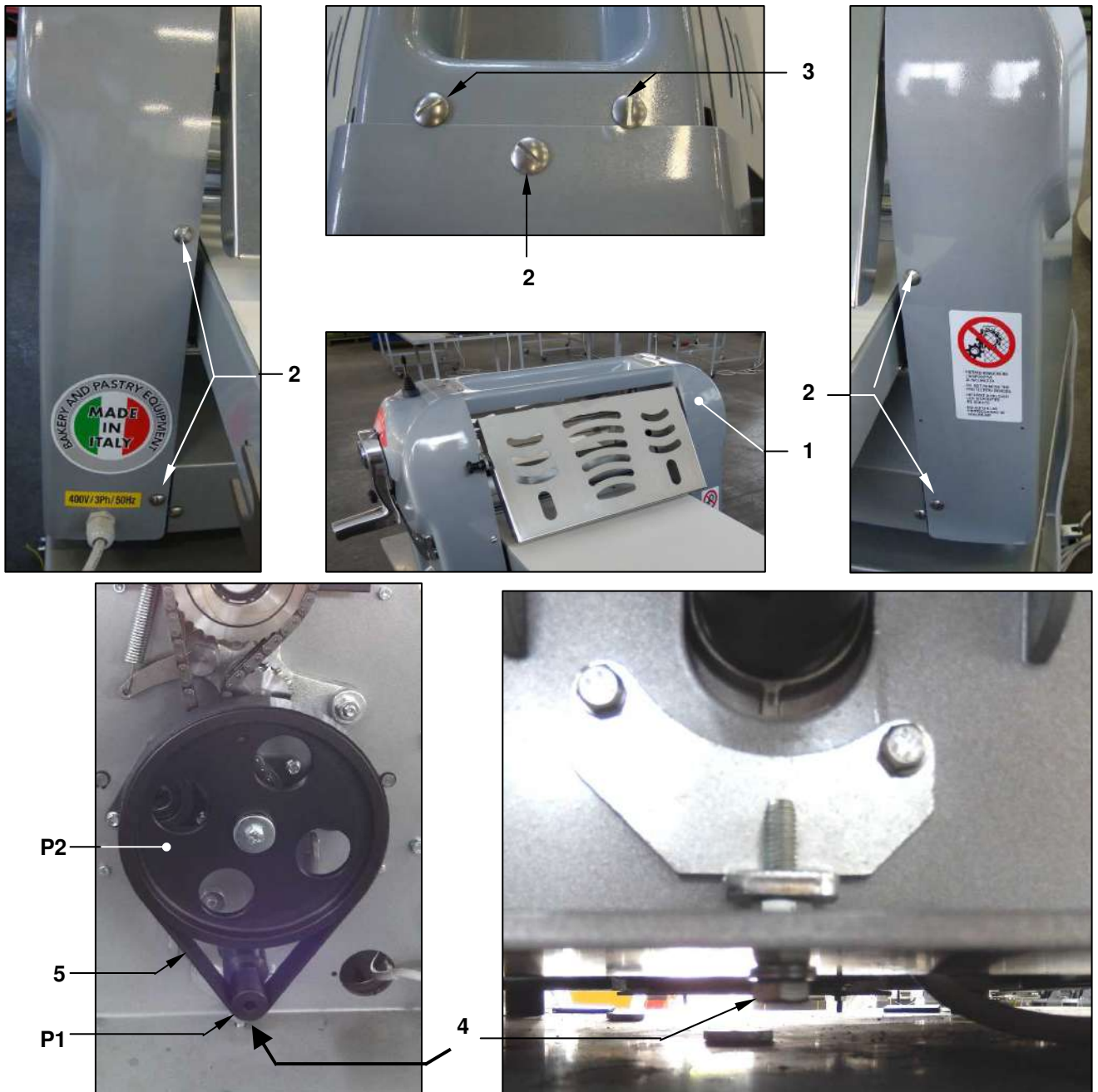

Figure 30 - Mod. SF450: adjusting the tension of the drive belt

4.3.3 SHEETER MOD. SF500 - SF600

Model SF500 uses a single belt, model SF600 uses a pair of V-belts.

With reference to Figure 31, to adjust the tension of the drive belt(s):

- remove the guard ref. 1 on the side opposite the controls. In order to do this, remove the fixing screws ref. 2 (three per side). Place the guard in a safe place and in a stable position.
- loosen the four screws ref. 3 and then loosen the nut ref. 4
- turn the head ref. 6 of the screw ref. 7 until the tension of the belt(s) ref. 5 is correct. The following values for T should be used (for the meaning of T refer to section 4.3.1):
for SF500 A = 4,8 mm T = 22,3 N (60 Hz) T= 22,4 N (50 Hz); for SF600 A = 3,72 mm T = from 14,7 to 32,3 N
- once it has been adjusted, tighten the nut ref. 4 and then tighten the four screws ref. 3 immediately afterwards.
- replace the guard ref. 1 on the upright and secure it using all the screws ref. 2

To replace the drive belt(s)

- turn the nut ref. 4 to slacken the belt(s) ref. 5 just enough so that it/they can be slipped off the pulleys P1 and P2
 - install the new belt(s) so that it is/they are properly seated on the pulleys P1 and P2
 - adjust the tension of the belt(s) ref. 5 as described above, but in this case, because the belt(s) is/are new the following should be used: for SF500 A = 4,8 mm T = 32,6 N (60 Hz) T= 32,7 N (50 Hz); for SF600 A = 3,72 mm T = from 14,7 to 32,3 N
- When the adjustment is complete, reinstall the guard ref. 1 and secure it using the screws ref. 2 as described above.

Use only original belts supplied by Flamic:

SF500: flat belt Poly-V type, Flamic code: C114101640012

SF600: V-belt type XPZ, Flamic code: C111000001237

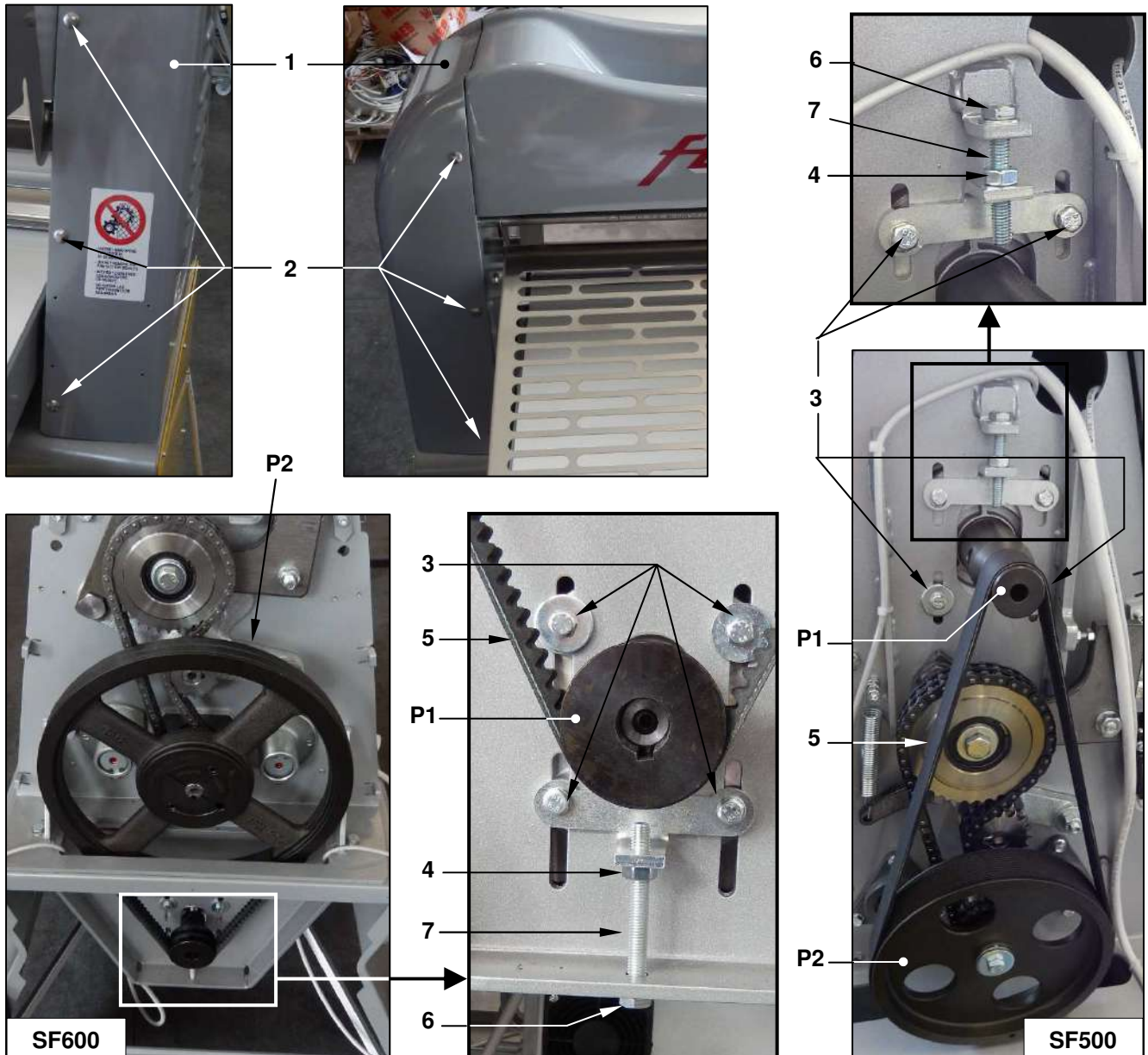

Figure 31 - Mod. SF500 and SF600: adjusting the tension of the drive belt(s)

4.4 ADJUSTING THE TENSION AND CENTRING OF THE CONVEYOR BELTS

To ensure the best performance and results, the tension of both conveyor belts must be properly regulated so that the dough moves smoothly and uniformly as it passes through the various rolling stages. Even small variations in the speed of one or both belts during the rolling process can subject the dough to abnormal stress and cause it to tear. This decreases the quality of the dough sheet or can even make it impossible to produce it. The thinner the sheet, the more evident this problem is.

The tension of the conveyor belts should be checked and adjusted whenever you notice that they move unevenly.

With reference to Figure 32, using an open-end spanner, turn the nuts ref. 1 on each side of the bench in order to move the roller ref. 2 forwards/backwards via the threaded rods ref. 3. Tension the conveyor belts as much as necessary (or slightly more) so that their speed is uniform both when empty and unloaded. Excessive tension would not provide any advantage but could cause rapid and abnormal wear.

Depending on the destination or the contractual agreements, the machine may be fitted with plates ref. 4 fastened with screws ref. 5. These have to be removed in order to carry out adjustments.

Once adjustments have been completed, replace the plates ref. 4 on both sides and fasten them using the screws ref. 5.

The same devices are also used to adjust the centring of the belt on the bench. With respect to this, it should be remembered that when in motion, a conveyor belt tends to move towards the side that is less taut. It is therefore very important that the tension is the same on both sides of the belt.

The tension and/or centring of the belts has to be carried out while the machine is in operation. Only in this way is it possible to see the effect of any adjustments.

WARNING! Do not place your hands in the zone in which the roller and belt converge to avoid the risk of trapping and dragging. Also, hold the open-end spanner firmly. If it were to fall onto the belt while it is in motion, it could cause serious damage to the machine.

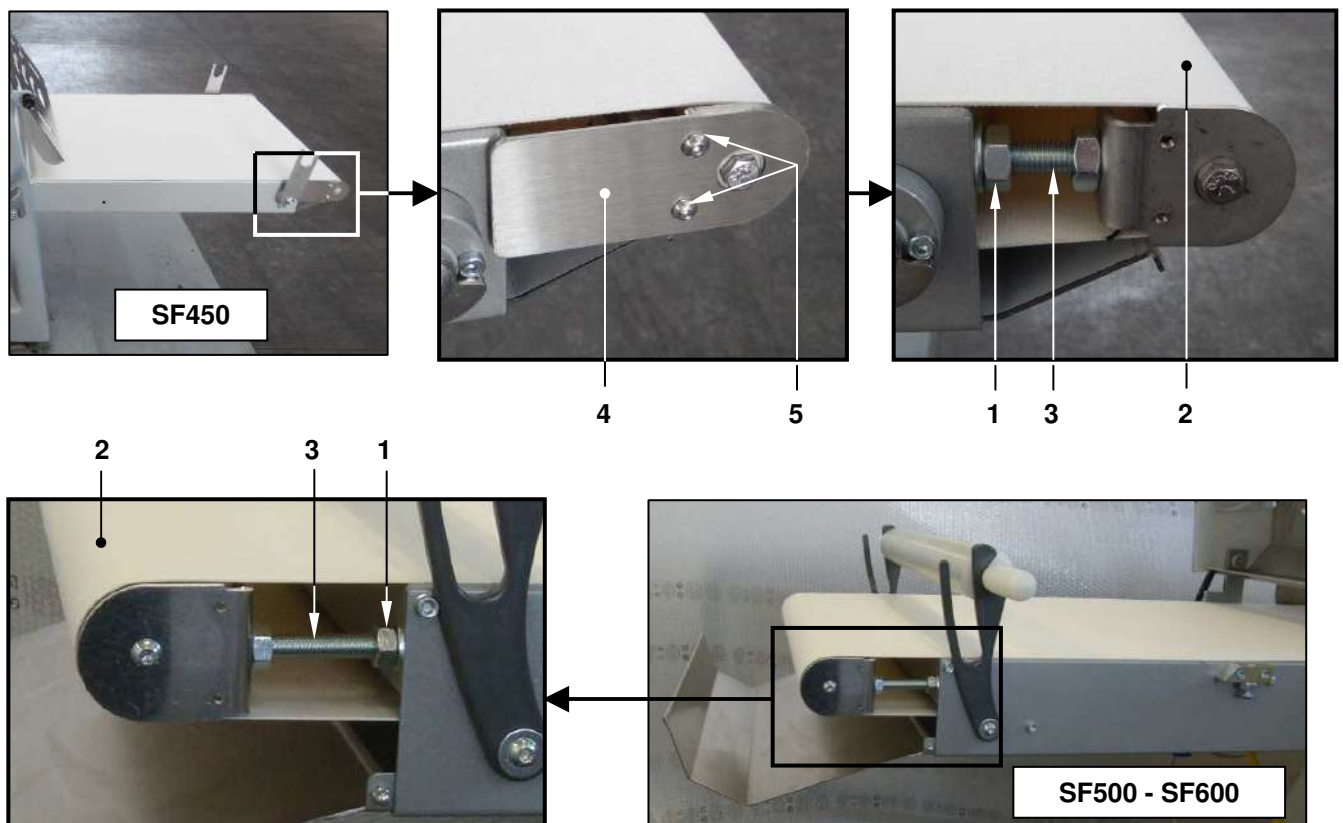

Figure 32 - Conveyor belt tensioning and centring system

4.5 REMOVING/INSTALLING THE SCRAPERS

The scrapers must be removed when the machine has to be cleaned.

They should be replaced when they are so worn and/or deformed that they no longer have an adequate scraping and cleaning effect on the rollers. To remove/install the scrapers, place the tables in the down position (working). Use only scrapers supplied by Flamic or by authorised dealers.

Before starting, implement the safety measures set out in section 4.1 and wear at least safety footwear with reinforced toecaps and abrasion resistant gloves.

4.5.1 UPPER ROLLER SCRAPERS

With reference to Figure 33 (the one shown is for mod. SF450, but the procedure is the same for other models), there are two scrapers ref. 1 installed on a single support ref. 2 that straddle the upper roller ref. 3.

To remove the scraper unit of the upper roller, simply unscrew and remove the butterfly screws ref. 4 on the top of the support ref. 2 (photos A - B - C) and remove the support upwards (photo D).

To install the scraper unit, place it astride the upper roller ref. 3 (photo C), align the through holes ref. 5 (photo E) with the threaded holes ref. 6 on the support rod ref. 7 (photo F) and tighten the butterfly screws ref. 4 (photo A).

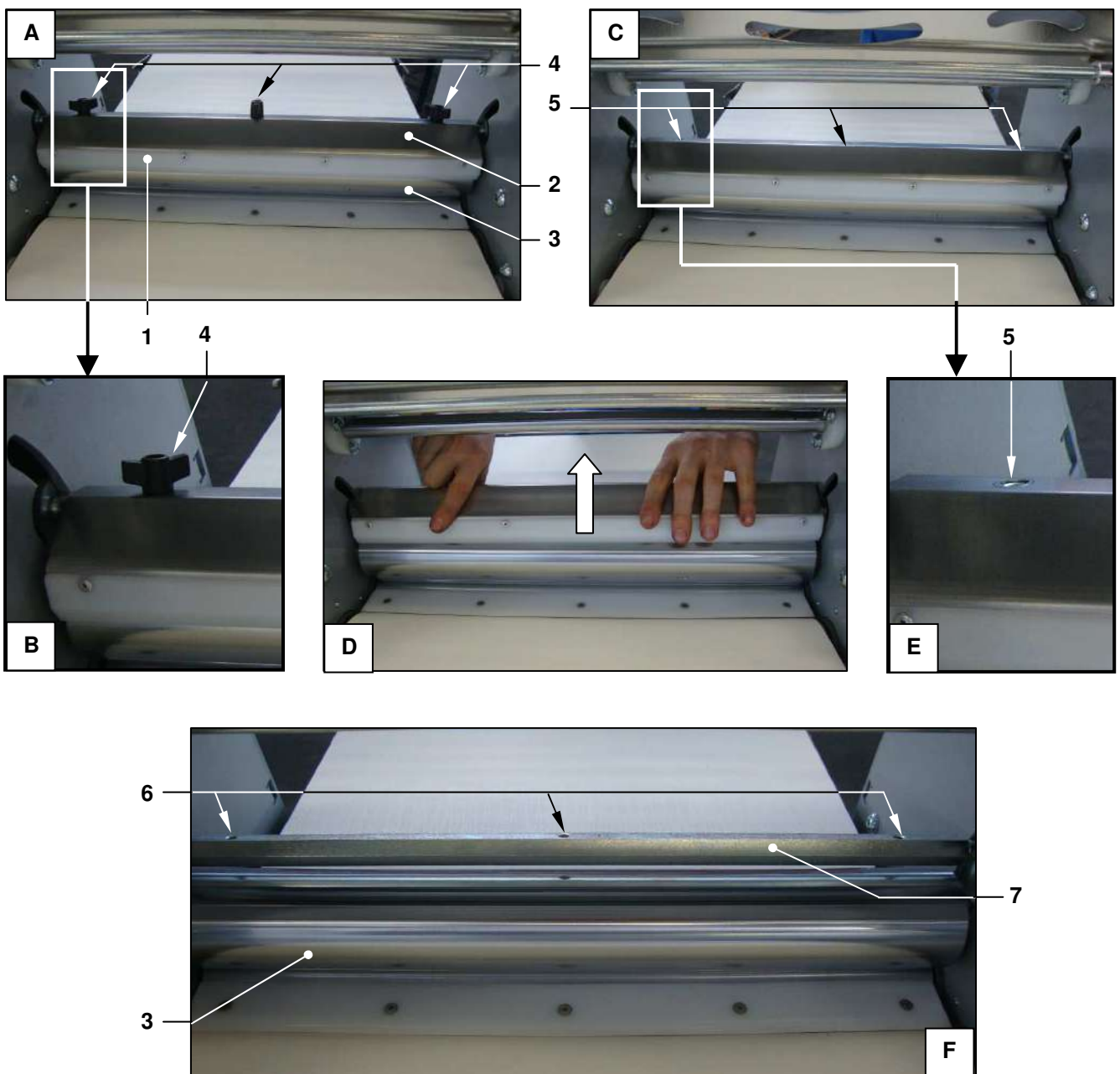

Figure 33 - Removing/installing the upper roller scrapers

4.5.2 LOWER ROLLER SCRAPERS

The two lower roller scrapers are independent and flush with the relative belts.

4.5.2.1 MOD. SF450

IMPORTANT! In order to remove the scraper to the left of the roller (looking at it from the controls side), the upper roller scraper unit has to be removed (see section 4.5.1).

With reference to Figure 34, **to remove a scraper** ref. 1 with the relative support and springs:

- unhook both springs ref. 2 from the pins ref. 3 (photos A - B)
- using one hand, push the scraper upwards from under the table (photo C) and with the other, remove it from above (photos D - E)

To install a scraper ref. 1:

- lower the scraper unit ref. 4 into the space ref. 5 between the conveyor belt ref. 6 and the roller ref. 7. The notch ref. 8 must be facing the side opposite the roller ref. 7 (photo F). The plates ref. 9, to which the springs are hooked ref. 2, must descend easily and smoothly (the springs ref. 2 must not stop against other parts)
- bring the scraper ref. 1 to rest in its lowest position (photo G)
- hook the springs ref. 2 onto their respective pins ref. 3 (photos B - A)

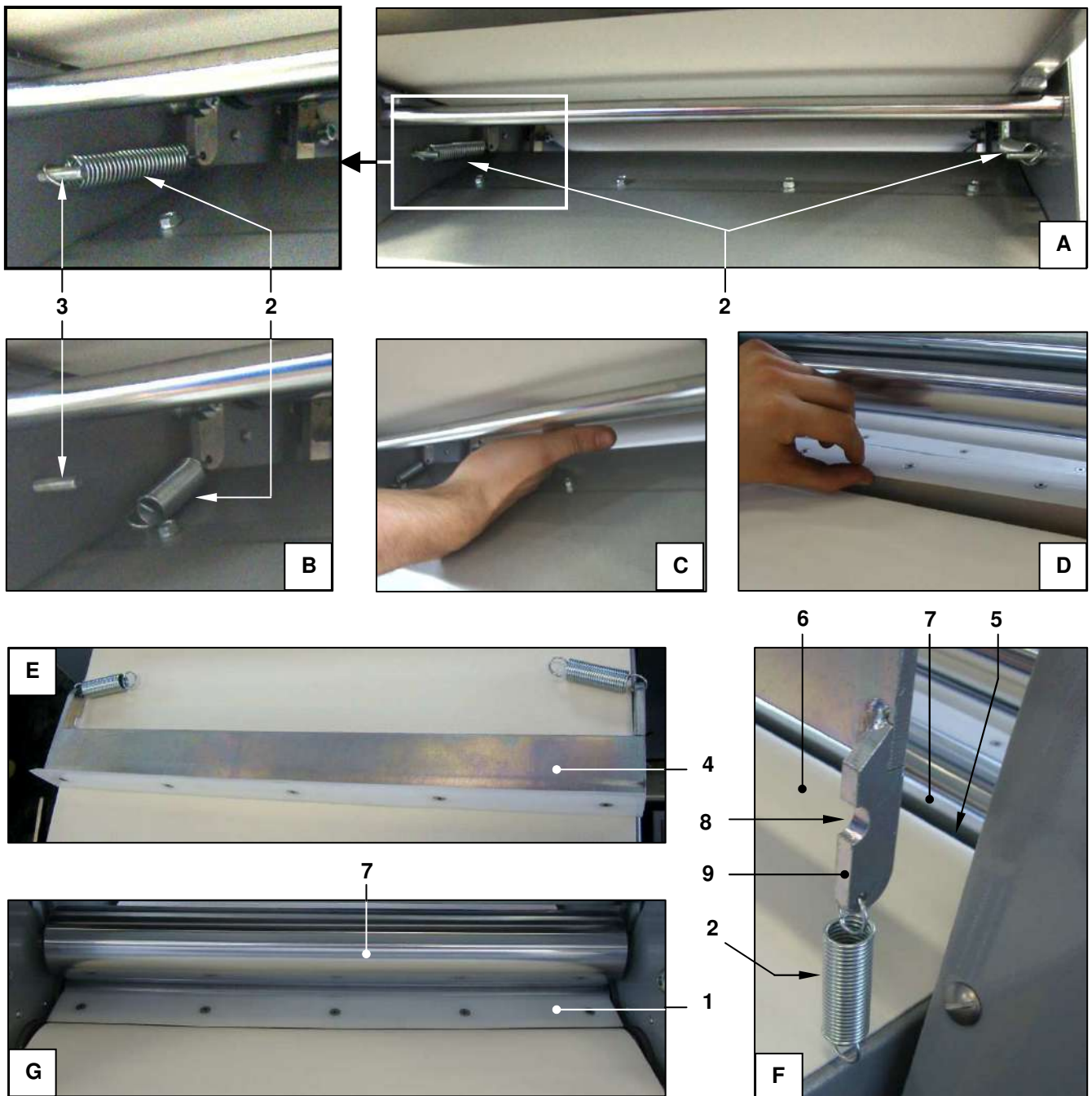

Figure 34 - Mod. SF450: removing/installing the lower roller scrapers

4.5.2.2 MOD. SF500

IMPORTANT! In order to remove the scraper to the left of the roller (looking at it from the controls side), the upper roller scraper unit has to be removed (see section 4.5.1).

With reference to Figure 35, **to remove a scraper** ref. 1, lower the lever ref. 2 completely (photos A - B). The scraper will move away from the belt and the thickening roller and can then be removed by pulling it upwards (photo C - D).

To install a scraper ref. 1:

- lower the scraper unit ref. 4 into the space ref. 5 between the belt ref. 6 and the roller ref. 7. The notch ref. 8 of the plates ref. 9 must be facing the side opposite the roller ref. 7 (photo E).
- bring the scraper ref. 1 to rest in its lowest position (photo F), then lift the lever ref. 2 until you hear a click (photo F). If the lever is accidentally raised too far beyond the position of the first click, lower it again until you hear the first click again (photo F).

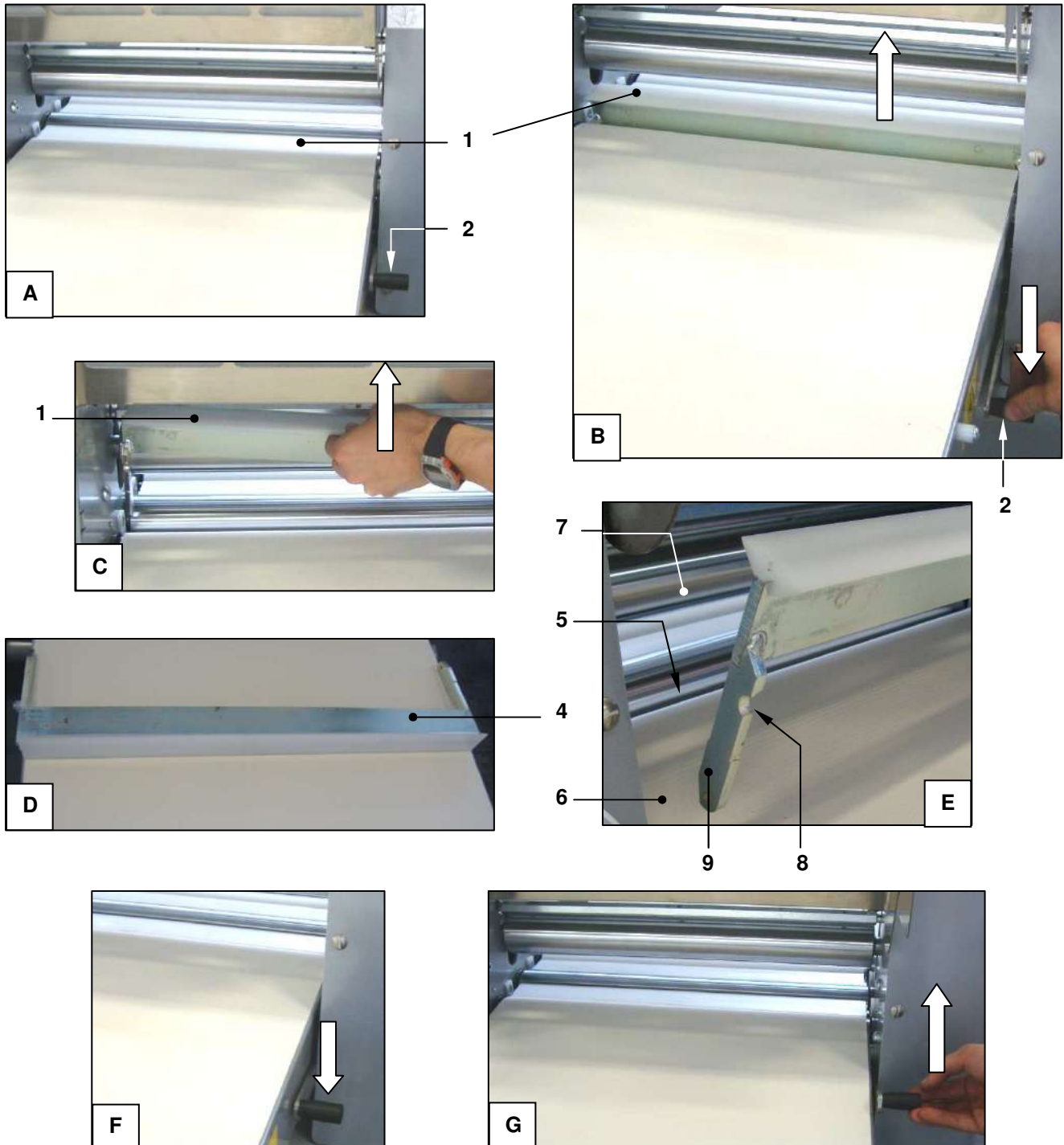

Figure 35 - Mod. SF500: removing/installing the lower roller scrapers

4.5.2.3 MOD. SF600

With reference to Figure 36, **to remove a scraper** ref. 1 lower the lever completely ref. 2. The scraper will move away from the conveyor belt and the thickening roller (photo B) and can then be removed by pulling it upwards.

To install a scraper ref. 1:

- lower the scraper unit ref. 4 into the space ref. 5 between the belt ref. 6 and the thickening roller ref. 7. The bevelled part ref. 8 of the plate ref. 9 must be facing towards the roller ref. 7 (photo D).
- allow the scraper ref. 1 to rest against its lower limit stop (photo F), then lift the lever ref. 2 completely (photo E).

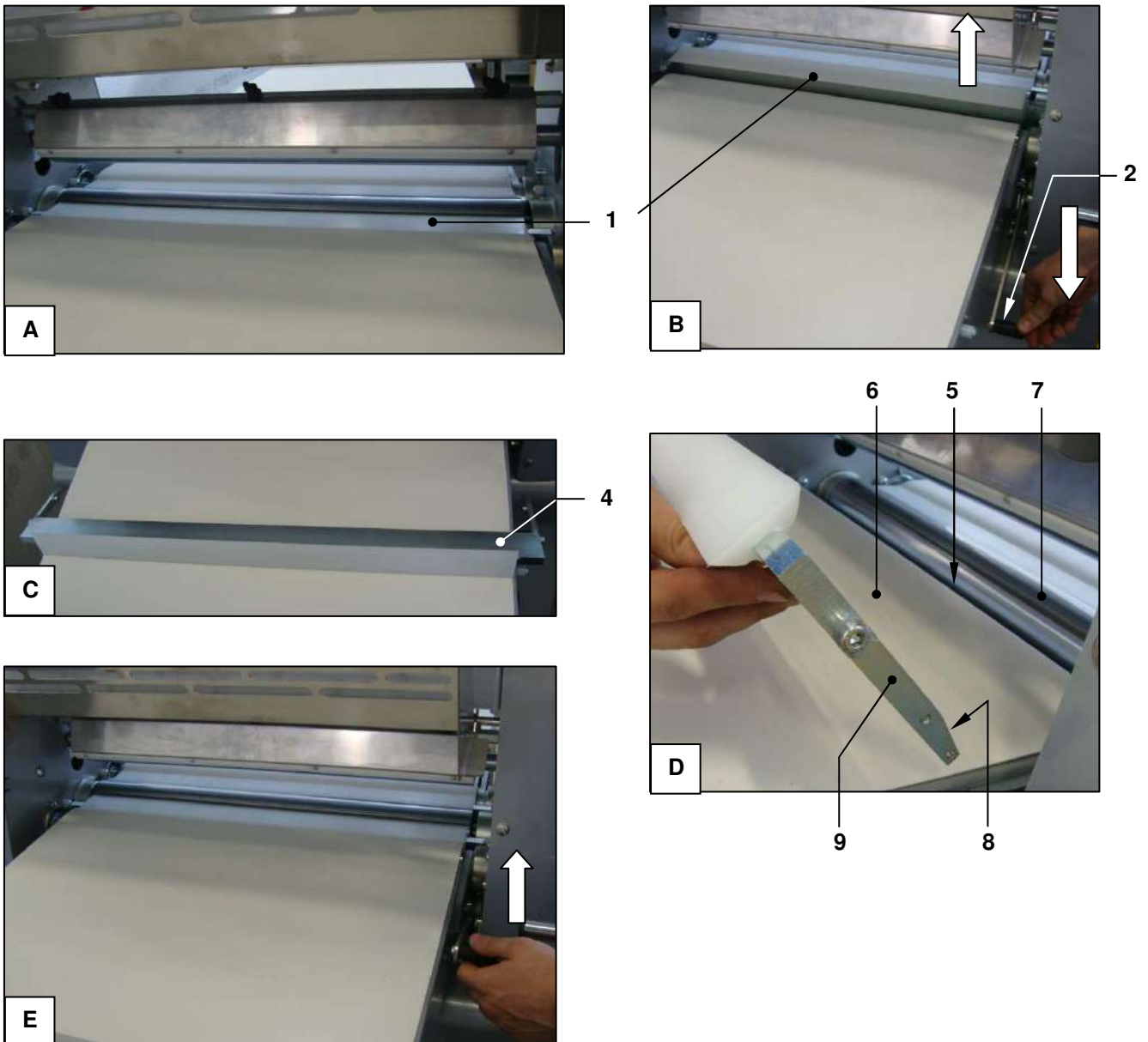

Figure 36 - Mod. SF600: removing/installing the lower roller scrapers

4.6 REPLACING THE CONVEYOR BELTS

The conveyor belts should be replaced when they are so worn and/or deformed and/or contaminated that they are no longer sufficiently reliable and/or provide an insufficient level of safety in terms of hygiene.

Use only belts supplied by Flamic or by authorised dealers.

For machines fitted with wheels, the work should only be carried out after they have all been locked with the brake levers (see section 3.2 and Figure 10).

Wear at least safety footwear with reinforced toecaps and abrasion resistant gloves.

Two operators are required for replacing a conveyor belt of which at least one has mechanical installation experience and the second is only required to support the table when necessary.

4.6.1 SHEETER MOD. SF450 AND SF500

Raise the interlocked guards completely (see section 3.5) and place the rollers as far apart as possible.

With reference to Figure 37, which shows mod. SF500 (for mod. SF450 the procedure is the same):

1. using a flat head screwdriver, prise up and remove the boss ref. 1 (photo A - B)
2. using a hex wrench (Allen key), loosen all the screws ref. 2. Then unscrew three of them completely and screw them as far as they will go into the threaded holes ref. 3.
3. alternately tighten the screws that were placed in the holes ref. 3 a bit at a time. This will remove the locking assembly ref. 4 from the central pin ref. 5 and make it possible to remove the thickness adjustment handle ref. 6 (photo C)
4. unscrew and remove the two screws ref. 7 and remove the rack ref. 8 (photo D)
5. after removing the side screws that are still securing it, remove the guard (casing) ref. 9
6. using a screwdriver, separate the internal terminal blocks from the control device actuators by releasing the tab (photos E - F).

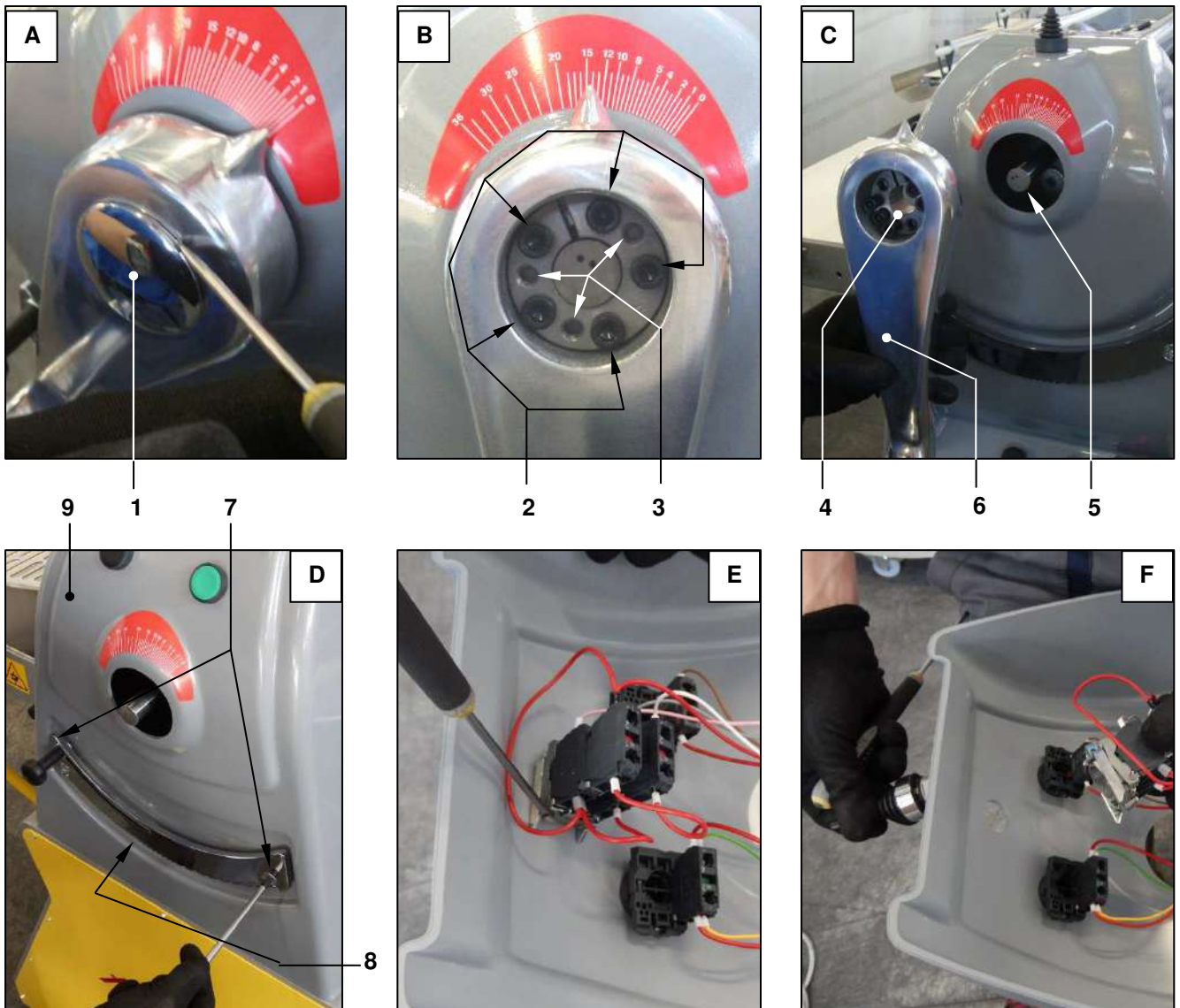

Start Figure 37 - SF450 and SF500: Removing the tables and replacing conveyor belts

7. remove the scraper from the roller on the side of the conveyor belt involved (section 4.5 and section 4.5.2).
8. remove the chain that moves the conveyor belt drive roller via the gears ref. 10 (see section. 4.7)
9. remove the tube ref. 11 by simply removing the screw ref. 12 from the back of the upright on the controls side (photo G)
10. remove the casing on the opposite side and remove the drive belt (see section 4.3.2 or 4.3.3)
11. unscrew and remove the screw ref. 13 and remove the pulley ref. 14 from the shaft ref. 15 (photos H - I)
12. remove the screws ref. 16 from the support ref. 17 (photo I) and the screws ref. 18 from the support ref. 19 on the opposite side (photo J).
13. position an aluminium alloy or steel point ref. 20 with a plastic end (head diameter 19 mm) against the end of the drive roller shaft ref. 21 taking care not to damage the ring of the bearing. Using a strong hammer, hit the head of the point until the shaft ref. 21 is removed from the support bearing ref. 17. Hold the support to prevent it from falling and keep it in a safe place (photos K - L)
14. loosen the conveyor belt completely (see section 4.4)
15. remove the drive roller ref. 22 from the controls side and place it in a safe place (photos M - N)

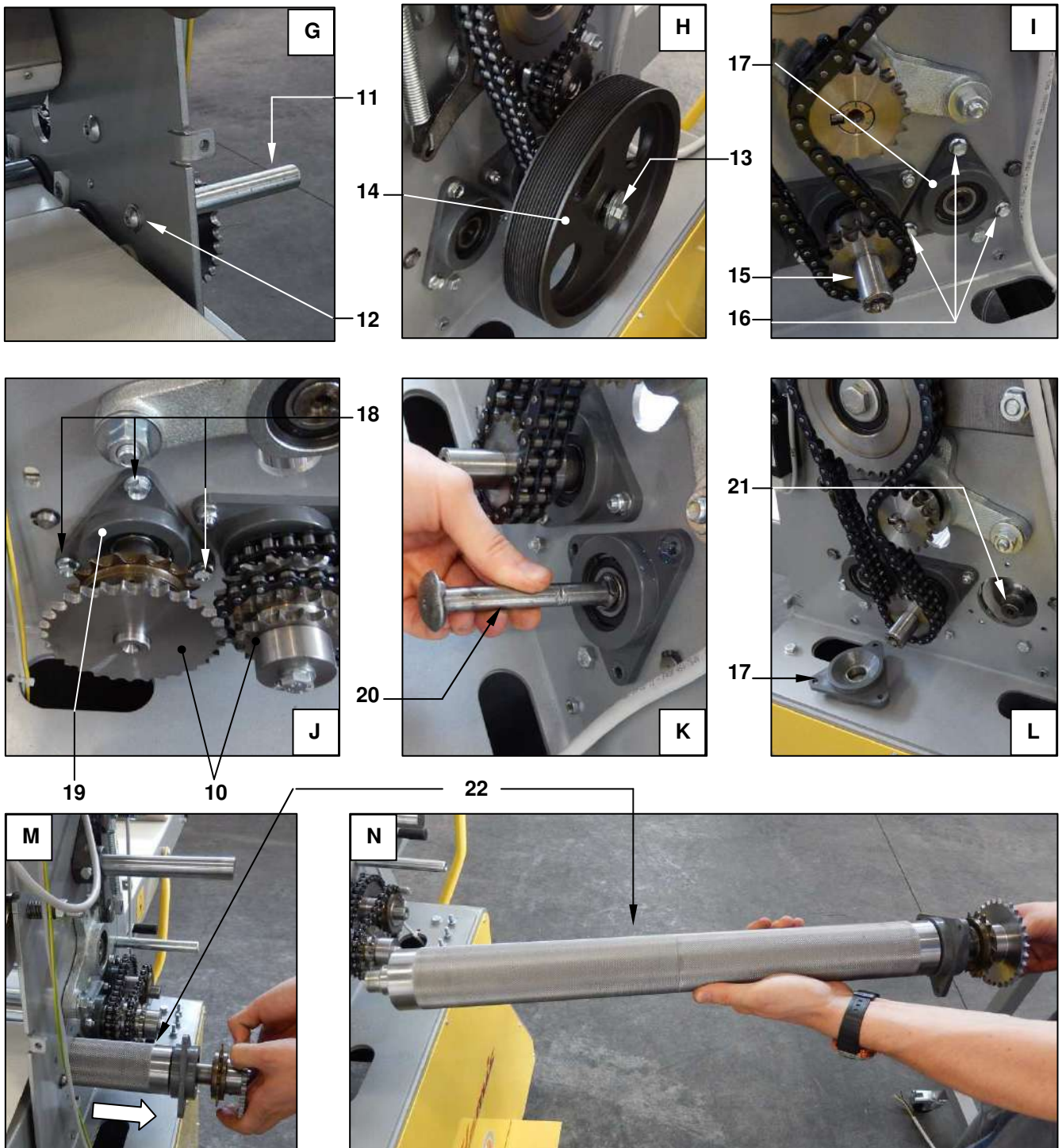

Continued Figure 37 - SF450 and SF500: Removing the tables and replacing conveyor belts

16. While one person supports the bench in a central position, so that it doesn't fall as soon as it is released, the first operator (skilled), using needle nose snap ring pliers, removes the snap ring ref. 23 (photo O). He then pushes the rod ref. 24 inwards (photo P), removes it from the other side (photo Q) and puts it and the spacers ref. 33 and ref. 37 Figure 38 to one side.
17. remove the table and place it on a sufficiently large surface as shown in photo R
18. remove the residue collection tray ref. 25 (see section 3.8)
19. unscrew the two side screws ref. 26 and relative nuts ref. 27 and remove the table support ref. 28 (photos R - S). Make a note of the position of the washers and spacers ref. 30 and 31 (photo T), because they have to be reinstalled in the same position.
20. rest the table on its side, as shown in photo U (hold it tightly to prevent it falling and causing injury or severe bruising). Remove the conveyor belt ref. 29 and replace it with a new one.

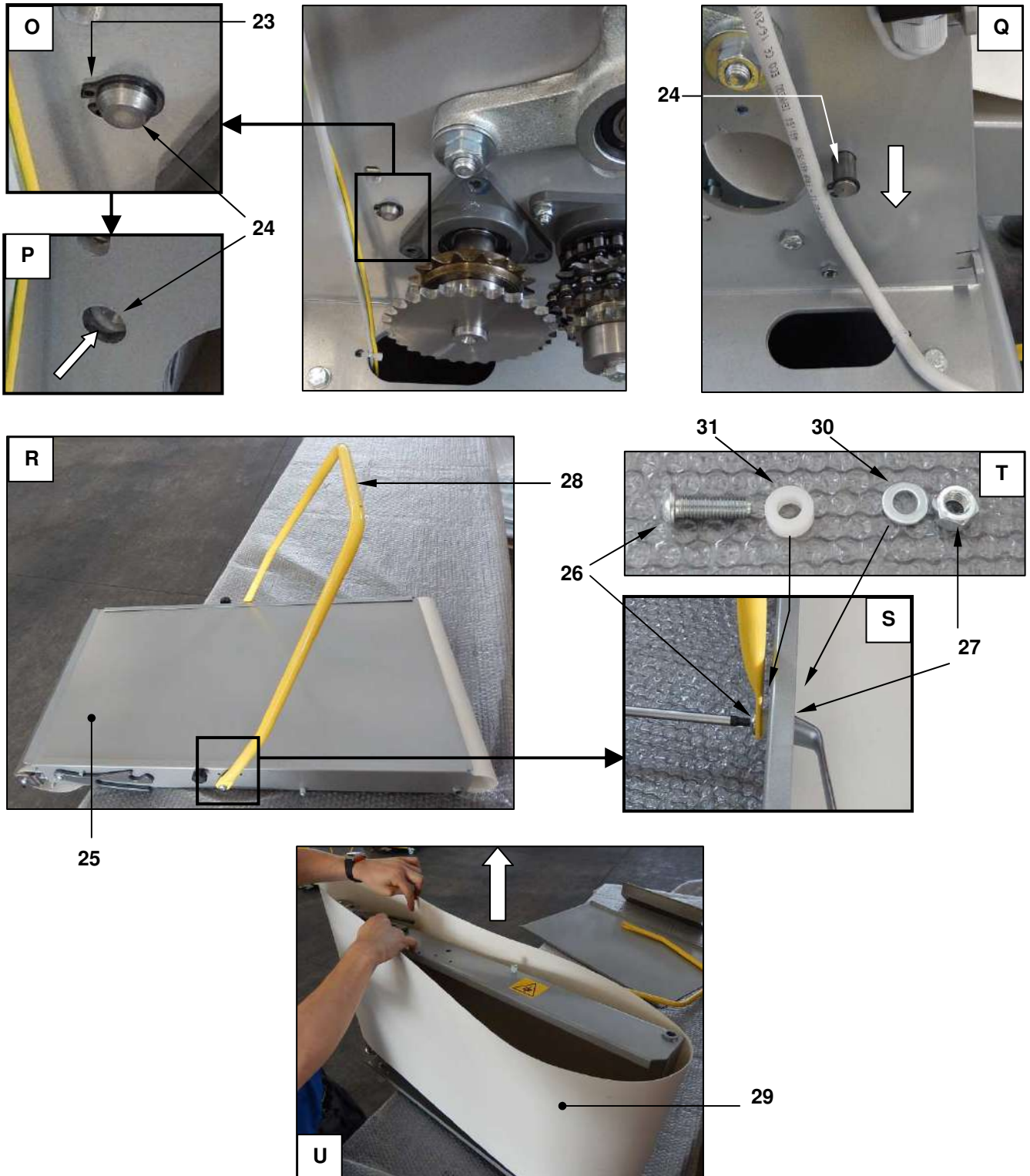

Figure 37 - SF450 and SF500: Removing the tables and replacing conveyor belts

To replace a table:

21. Install the table support ref. 28 and secure it using the screws and nuts ref. 26 and ref. 27. The washer ref. 30 should be used with the nut ref. 27 inside the table whilst the spacer ref. 31 should be placed outside, between the support and the bench (photo S). Do not install the residue collection tray ref. 25 and leave the conveyor belt ref. 29 very slack

With reference to Figure 38:

22. one person should insert the rod ref. 24, so that it just protrudes from the side of the upright ref. 32 (the side opposite the controls) and places the plastic spacer ref. 33 on the part that protrudes inside the upright. The other person should hold the table between the uprights, so that the hole ref. 34 at the end of the side is lined up with the rod ref. 24.

23. push the rod ref. 24 into the hole ref. 34 and from underneath, guide it into the hole ref. 35 on the opposite side, but make sure that it doesn't go into the hole ref. 36 of the upright ref. 38 on the controls side.

24. place the spacer ref. 37 onto the end of the rod ref. 24. Insert the rod into the hole ref. 36 of the upright ref. 38 on the controls side and using needle nose snap ring pliers, install the snap ring ref. 23 in the groove at the end of the rod ref. 24.

25. rest the support ref. 28 onto the lower rests ref. 39. You can now let go of the table that will be firmly supported by the rod ref. 24 and the support ref. 28.

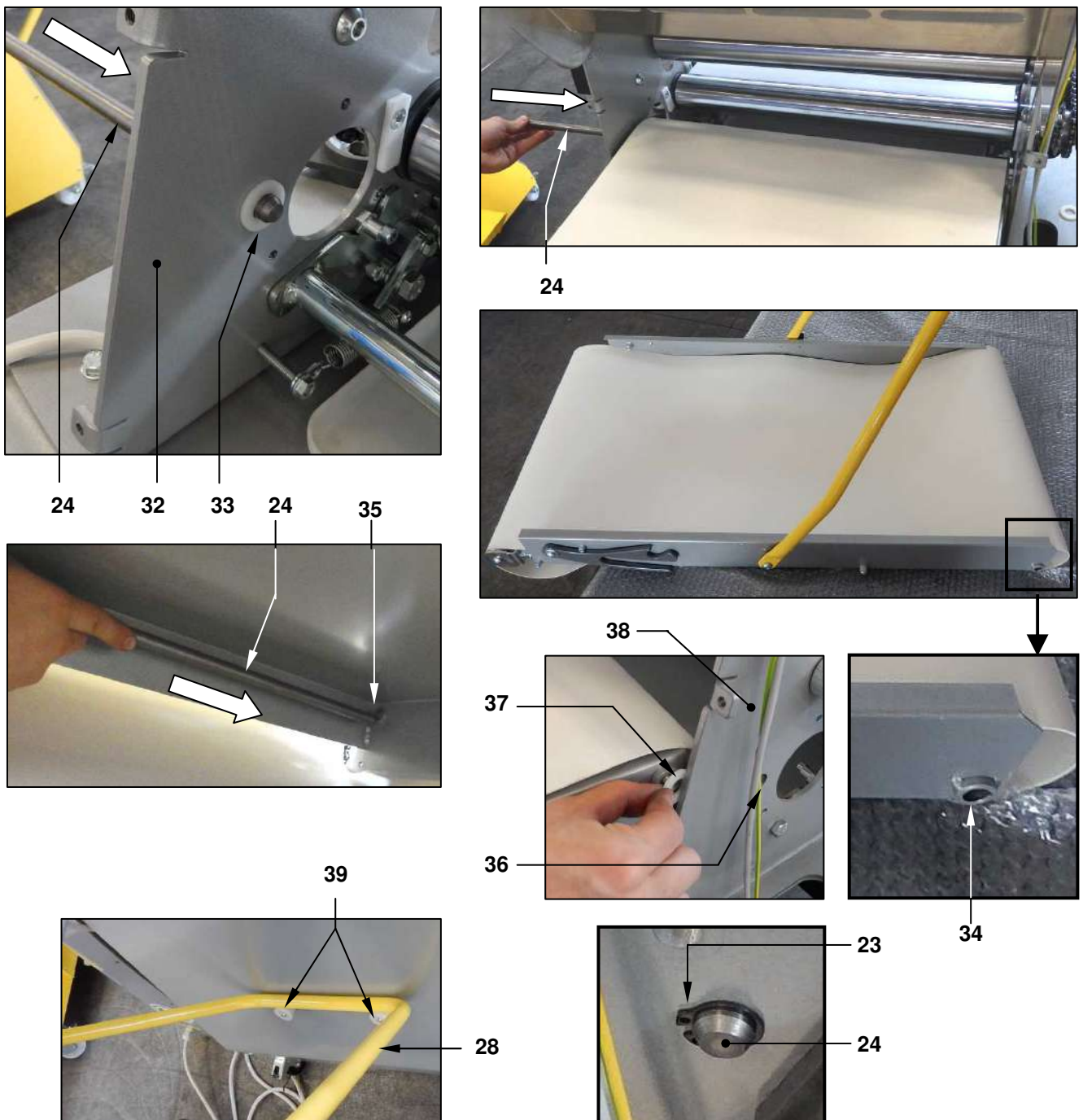

Figure 38 - SF450 and SF500: installing the table support rod between the uprights

26. with reference to Figure 39, bring the conveyor belt ref. 29 from the condition shown in photo A to the condition shown in photo B, in which both sides are above the edges ref. 40 of the table.

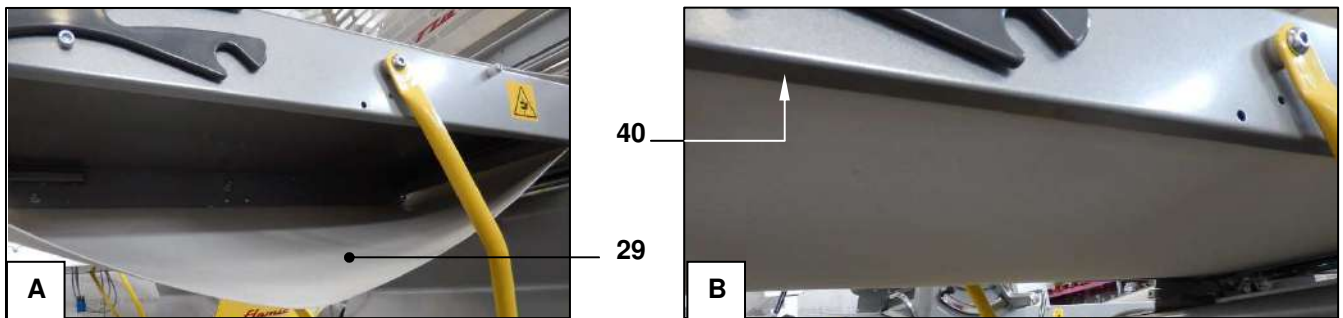
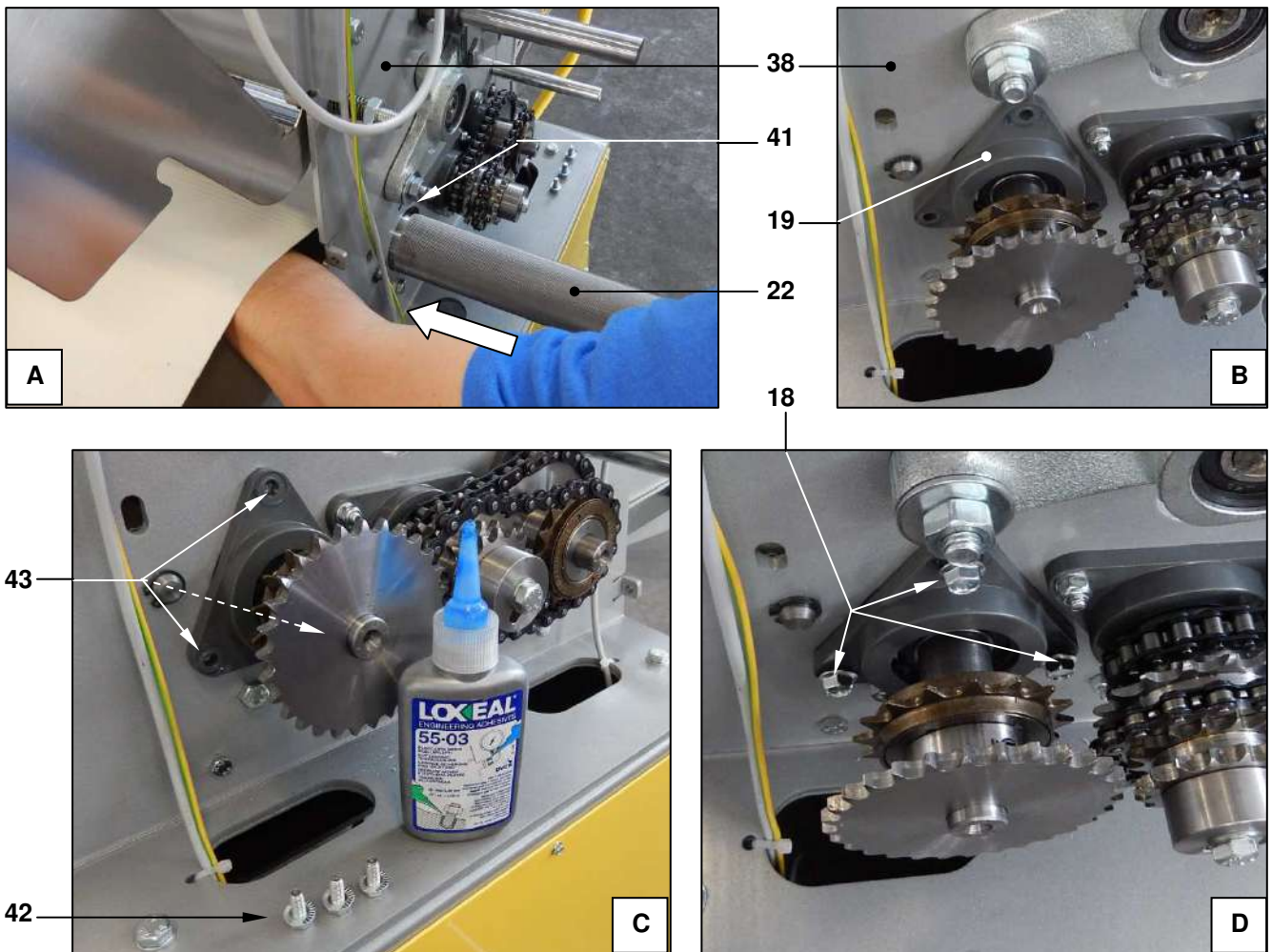
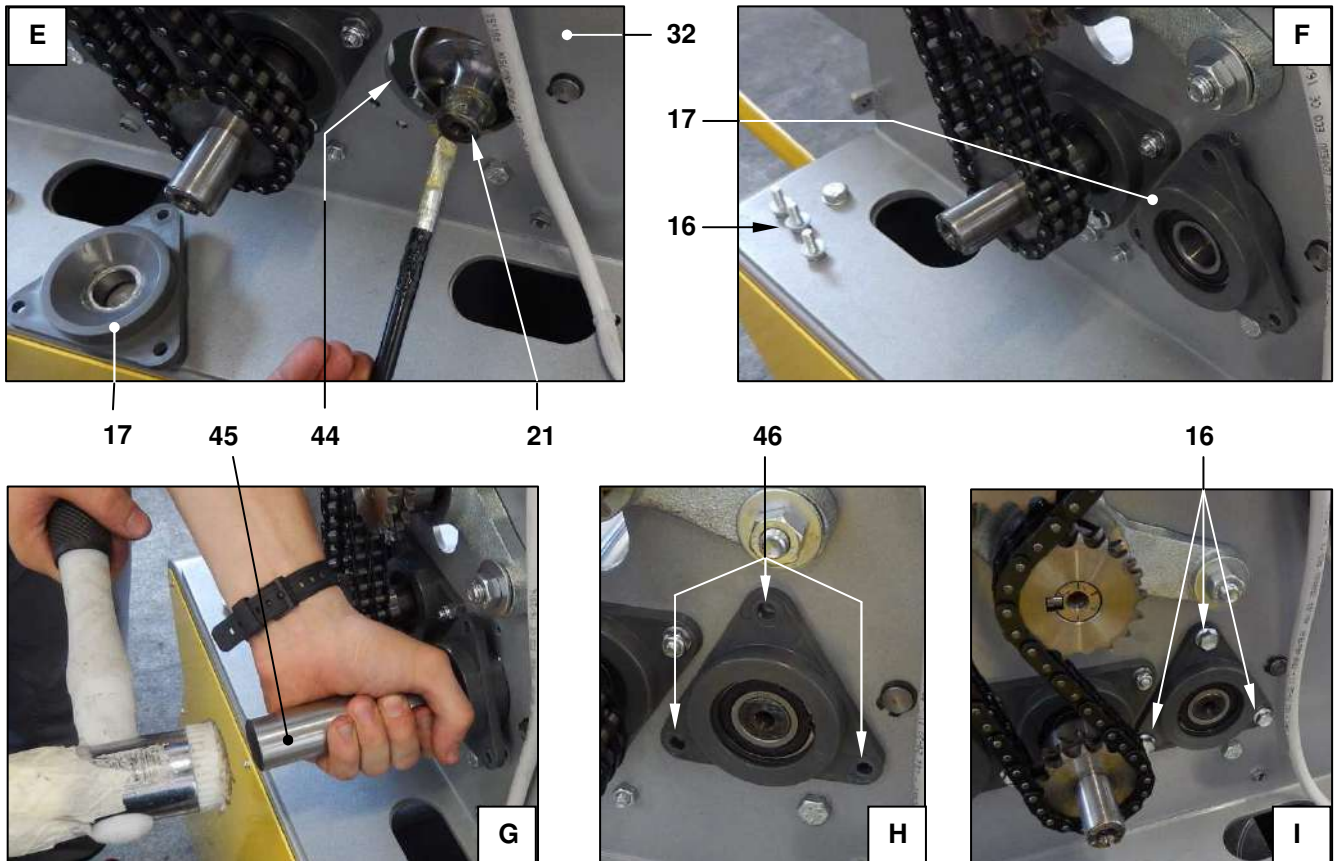

Figure 39 - SF450 and SF500: preparing the belt before installing the drive roller

27. with reference to Figure 40, make the necessary space with one hand and with the other insert the roller ref. 22 into the hole ref. 41 of the upright on the controls side ref. 38, passing it inside the belt ref. 29 (photo A) until the support ref. 19 is in contact with the upright ref. 38 (photo B). After having put some thread locking compound on the threads (use LOXEAL 55-03 or equivalent), place the screws ref. 18 into the holes ref. 43 and screw them into the corresponding threaded holes in the upright ref. 38 until the support is fixed into place ref. 19 (photos C - D).
28. using a brush, grease the pin ref. 21 with mechanical assembly grease (**wear oil resistant gloves, read the product safety data sheet and follow the instructions**). Then insert the support ref. 17 as far as it will go onto the pin ref. 21 and at the same time place it in the seat ref. 44 on the upright (photos E - F).
29. place a \varnothing 30 flat ended steel rod ref. 45 against the inner ring of the bearing and hit it using a strong plastic hammer until the support ref. 17 is flush with the upright ref. 32 (photo G).
30. after having smeared them with the thread locking compound described above, insert the screws ref. 16 into the holes ref. 46 and tighten them gradually and alternately into the corresponding holes ref. 32 on the upright until the support ref. 17 is locked securely against the upright ref. 32 (photos H - I).



Start Figure 40 - SF450 and SF500: installing a conveyor belt drive roller



End Figure 40 - SF450 and SF500: installing a conveyor belt drive roller

With reference to Figure 41

31. place the pulley ref. 14 onto the shaft ref. 15 and secure it using the screw ref. 13 (photos A - B)
32. install the drive belt and adjust its tension (see section 4.3)
33. hold the tube ref. 11 on the outside of the upright ref. 38 on the controls side and fasten it with the screw ref. 12 (photo C)
34. install the chain ref. 46 (photo F) (see section 4.7) that drives the conveyor belt drive roller ref. 22 Figure 40

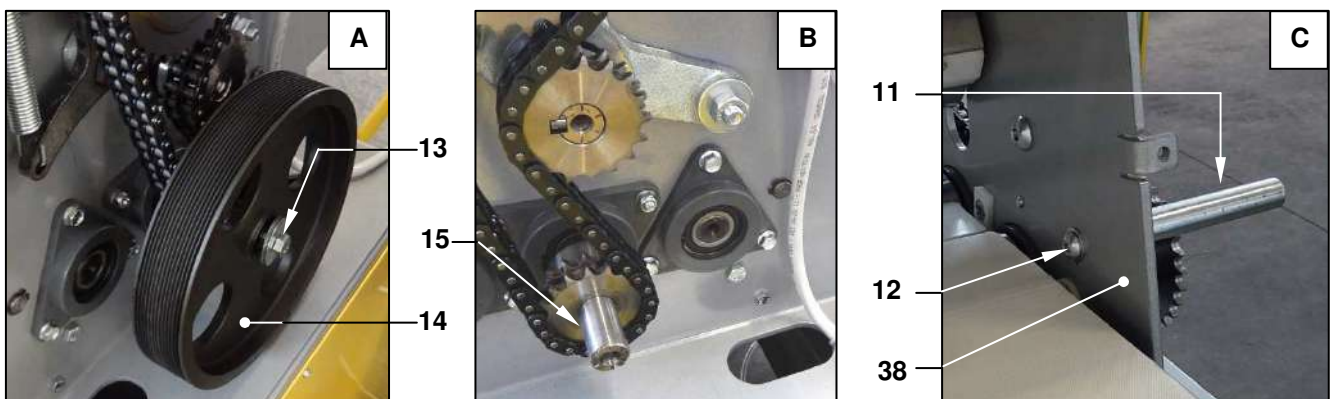

Start Figure 41 - SF450 and SF500: installing the handle and other parts

35. place two normal sheets of paper, 80g/ m² ref. 47 between the two rollers
36. using a locking adjustable wrench ref. 48, rotate the shaft ref. 49 and lower the upper roller assembly completely (photos D - E)
37. insert two M12 hexagonal head bolts or larger, between the bar ref. 50 (if necessary, remove the upper scrapers, see section 4.5) and the shaft ref. 49 that have a total length of 70 mm for the SF450 and SF500 models and 60 mm for the SF 600 model, with their nuts screwed on but without the ends of the screws protruding. Turn the nuts until the screws+nuts are locked against the bars. Check that the sheets of paper are gripped between the rollers (photo E shows the assembly tools used by Flamic instead of the nuts and bolts, but the principle is the same).
38. reinstall the control devices in their original positions on the casing ref. 9. Press the actuators ref. 51 and the terminal blocks together ref. 52 through the holes ref. 53 (photo G)
39. install the casing ref. 9 on the controls side and secure it using all the screws provided.

40. install the rack ref. 7 and secure it using the two screws ref. 8 (photo H)
41. replace the screws ref. 2 of the handle ref. 6 locking assembly ref. 4 into their original position. Place the handle ref. 6 on the shaft ref. 5 (photo I) and position it 2-3 mm from the rack ref. 7 (the pin ref. 7 protrudes a few mm with respect to the locking assembly). Then gradually tighten the screws ref. 2 in a crosswise pattern (see tightening sequence example V1 to V5 in photo K). Stop when the screws start to become tight.
42. keep the plate ref. 54 under the hand grip of the handle ref. 6 pressed so that the tooth ref. 55 is disengaged from the rack. Then move the handle through the length of its stroke and check (also by using a thickness sample) that the distance between the tooth ref. 55 and lower profile of the plate ref. 7 is 2-3 mm in every position (photo J) and that in every position between handle and the internal face of the rack there is a gap of approximately 2 mm.
43. check that the sheets of paper ref. 47 are pressed between the rollers (it must not be possible to remove them by pulling)
44. check that the tooth ref. 55 engages properly at several points of the plate ref. 7
45. engage the handle in the fourth notch of the rack starting from the lowest rolling thickness and using a torque wrench set to 7 Nm (no greater in order not to damage the locking assembly), gradually tighten the screws ref. 2 in a crosswise pattern (see tightening sequence example V1 to V5 in photo K).
46. insert the boss ref. 1 Figure 37/A in its seat on the locking assembly

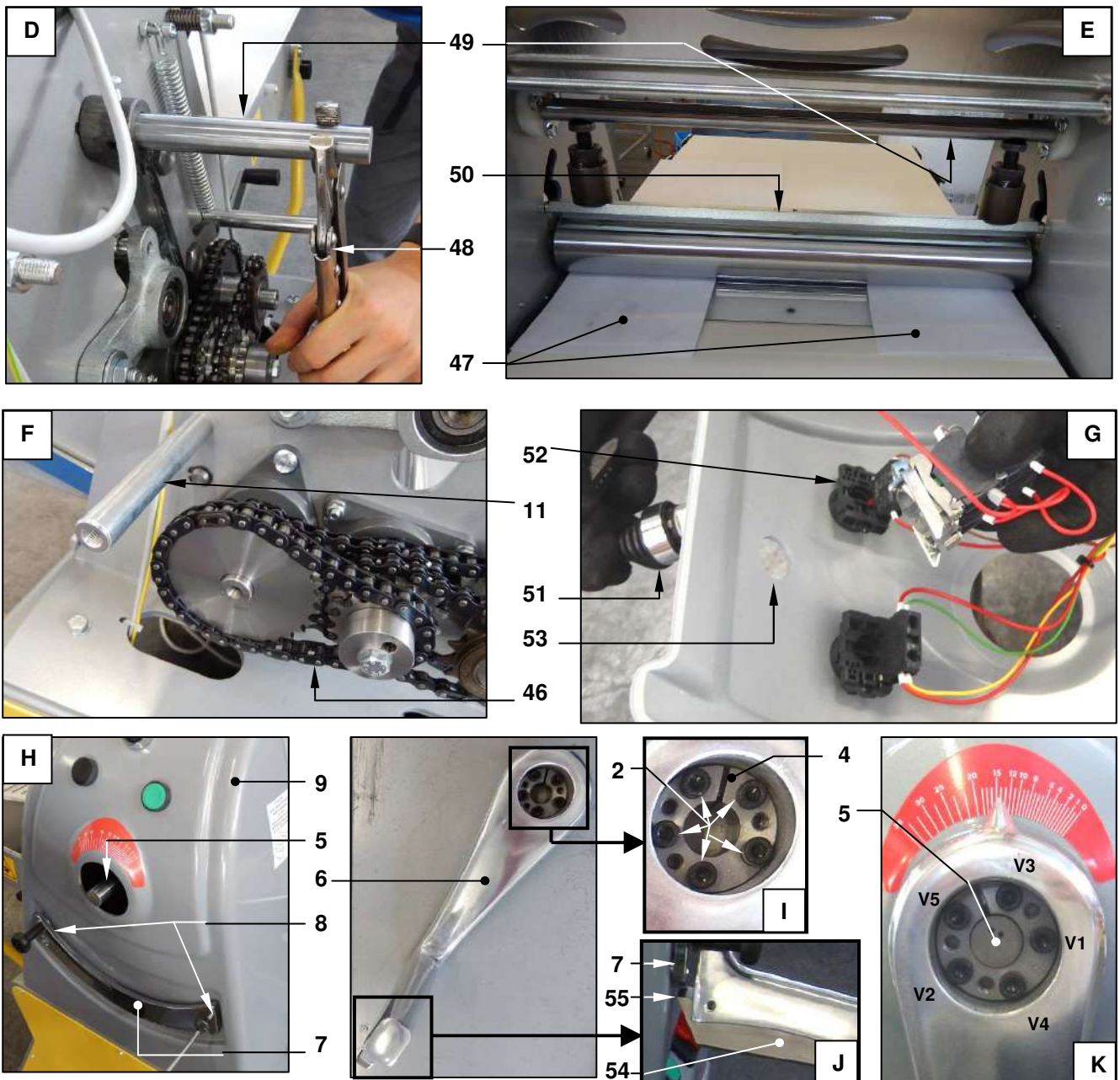

End Figure 41 - SF450 and SF500: installing the handle and other parts

47. Install the casing on the side opposite the controls (see section 4.3)
48. Install the lower scraper and, if appropriate, the upper scraper unit (see section 4.5)
49. adjust the tension of the conveyor belt (see section 4.4)
50. insert and (for SF500) secure the residue collection tray in position (see section 3.8).

4.6.2 SHEETER MOD. SF600

The instructions for installing and removing a table are given in section 3.4. Once the table has been removed, the procedure for replacing the conveyor belt is the same as described for models SF450 and SF500 in section 4.6.1, from point 17 to point 21.

4.7 REPLACING A DRIVE CHAIN

Before starting, implement the safety measures set out in section 4.1 and wear work gloves.

This operation is considered **special/extraordinary maintenance**.

With reference to Figure 42, to remove, for example, the chain ref. 1:

1. Remove the casing of the side on which the chain is to be replaced; for the controls side casing, follow the instructions in section 4.6.1 from point 1 to point 6 (these are also valid for model SF600). For the casing on the opposite side, follow the instructions in section 4.3.2 for model SF450 or section 4.3.3 for models SF500 and SF600
2. Using a pair of needle nosed pliers ref. 2, remove the joint ref. 3 (photo B). Then remove the link plate ref. 4 and remove the pair of pins ref. 5 (photo C). The chain ref. 1 can now be removed (photos D - E)

To install a new chain:

3. Wrap it around the gears (ref. 6 and ref. 7 in the example shown in Figure 42). Then join its ends so that after you have positioned the plate ref. 4, you can insert the pair of pins ref. 5 in the holes of the external link plate (use new plates and pins. The joint ref. 3 should also be new).
4. Lastly, fasten the link with the spring clip ref. 3 using the long-nose pliers ref. 2.
5. Once finished, replace the casing that had been previously removed and secure it using all the screws and in the manner indicated.

The chain is properly tensioned when it does not appear to be rigid (otherwise there is the risk of it breaking) when pressed in the middle of a free section with your thumb, but it gives a little and then springs back to its original position. The links of the chain should be just free enough to rotate on the pins, but at the same time not slack (otherwise they could slip off the gear). If you are unsure about how to correctly adjust the tension of the chain, do not use the machine and contact Flamic as soon as possible who will provide you with the necessary information. The tension of the chain should be checked, as described above, at least every two weeks.

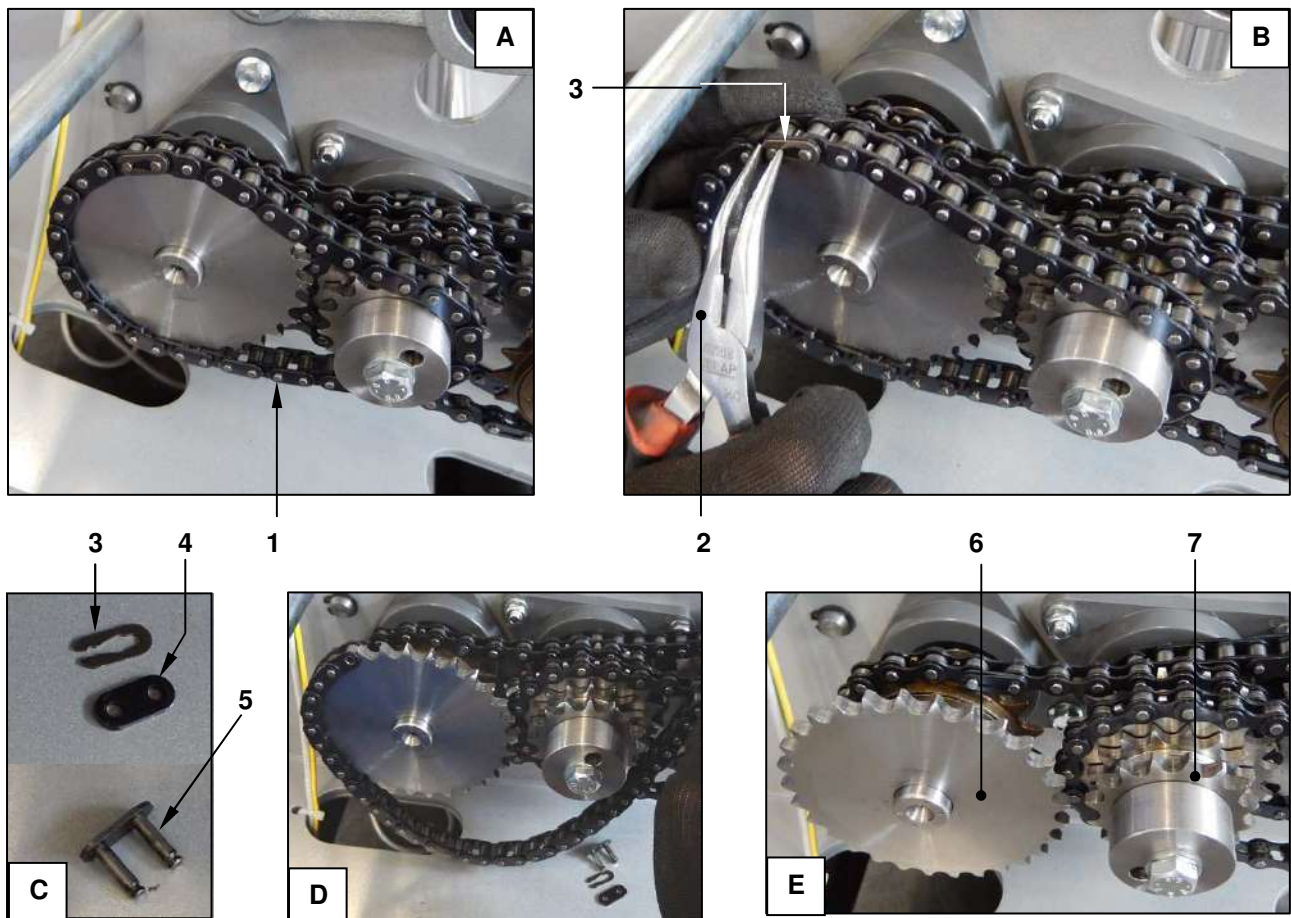

Figure 42 - Replacing a drive chain

In the table below, with reference to Figure 43, the length (in number of pitches) and the part number for ordering it from Flamic is indicated for each chain for each model of dough sheeter. The chains are provided with all the accessories necessary for connecting their ends (joints, connecting links etc.)

Mod.	Controls side (single chain)				Opposite side (double chain)	
	C1		C2		C3	
	Type and No. of pitches	Code	Type and No. of pitches	Code	Type and No. of pitches	Code
SF450 SF500	06-B1 3/8 x 7/32" 36 pitches	109010030	081-1 1/2 x 1/8" 27 pitches	109010031	06-B2 3/8 x 7/32" 69 pitches	109010027
SF600	083-1 1/2 x 3/16" 30 pitches	126010022	083-1 1/2 x 3/16" 28 pitches	126010023	06-B2 3/8 x 7/32" 73 pitches	126010025

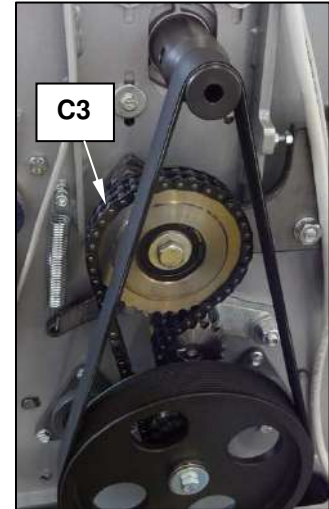
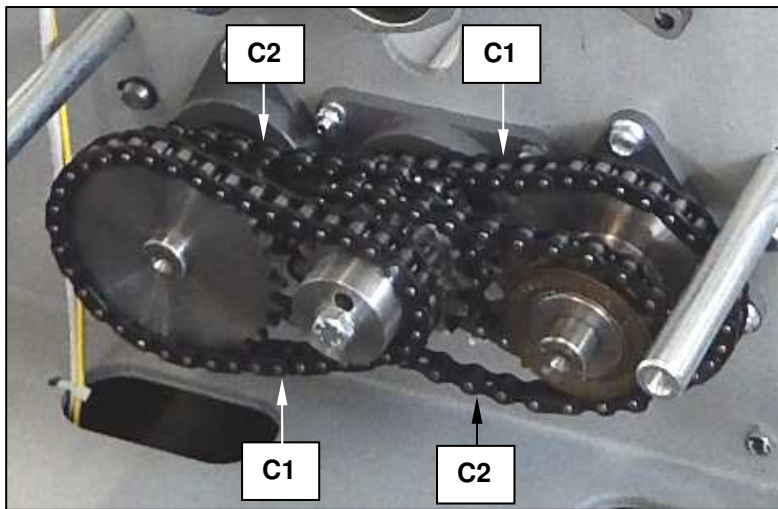

Figure 43 - Drive chains

4.8 ELECTRICAL SYSTEM MAINTENANCE

Given the high risk and the severity of harm that may be caused in the event of an accident, **all work**, even if simple (e.g. replacing a fuse), that is related directly or indirectly to the electrical equipment of the machine **must be carried out by authorised experienced technicians (special/extraordinary maintenance)** who possess the technical and regulatory knowledge to carry them out safely and in a workmanlike manner. They must first read and understand the contents of this manual.

The same applies for the replacement of the safety micro switches, described in detail in section 4.9. Because of the nature of the checks and any adjustments that need to be carried out this work also requires mechanical skills and knowledge.

WARNING FOR MACHINES FITTED WITH AN INVERTER

After having switched off and isolated the power supply, a residual voltage in the inverter could pose a serious safety hazard for persons that come into contact with parts still powered by this voltage. Section 5.2.4.7 provides further details on the subject and information regarding the precautions to take to avoid exposure to hazards of an electrical nature.

4.9 REPLACING THE MICRO SWITCHES OF THE INTERLOCKED GUARDS

Bearing in mind what was written in section 4.8, **before starting, follow the procedure indicated in section 4.1.**

With reference to Figure 44, to access the micro switches ref. 1 of the interlocked guards ref. 2

- mod. SF 450: remove the rolling thickness adjustment handle, the rack and the casing from the upright on the controls side (photo A) by following the instructions in section 4.6.1 from point 1 to point 6.
- mod. SF500 and SF600: remove the casing from the side opposite the controls by following the instructions in section 4.3.3.

The micro switches ref. 1 of model SF 450 are shown in photo A and those of models SF 500 and SF600 in photo B. To replace a micro switch, proceed as follows:

1. using a hex wrench (Allen key), remove the screws ref. 3 (photo C)
2. using a cross-head screwdriver, remove the screw ref. 4 and then remove the cover to access the contacts ref. 5 (photo D)
3. loosen the screws ref. 6 of the terminals (photo E) and unscrew the cable gland ref. 7. Remove the cables ref. 8 from the micro switch, noting the position of the white and brown wires with respect to the terminals.
4. Insert the wires ref. 8 into the new micro switch and connect them to the terminals according to the positions noted above. Tighten the screws ref. 6 and then tighten the cable gland ref. 7.
5. Replace the cover ref. 5 and fasten it using the screws ref. 4.

6. put some medium thread locking compound (4 LOXEAL 55-03 or equivalent) on the threads of the screws ref. 3 and, keeping the through holes ref. 9 of the micro switch aligned with the corresponding threaded holes in the upright, insert the screws ref. 3 and tighten them until the micro switch ref. 1 is fixed in place. The physical characteristics and performance of the new micro switch must be the same or better than the one that was removed (same dimensions and same centre distance between the screw holes, stable closure of contacts with guard lowered etc.). With the guard lowered completely the head ref. 10 of the micro switch must enter the recess ref. 11 of the cam ref. 12 and must not be pressed.
7. Check that the micro switch is triggered (you hear a slight click) when the distance between the guard and the conveyor belt is less than the maximum D_L value indicated in section 5.2.2, part 1. If it doesn't, loosen the screws ref. 2 and move the micro switch (the screw holes ref. 2 allow slight adjustments to be made) until it does.
8. (mod. SF450) Install the casing of the upright on the side opposite the controls, the thickness adjustment handle and the rack, following the instructions in section 4.6.1, from point 35 to point 46.
(mod. SF500 and SF600). Install the casing of the upright on the side opposite the controls following the instructions in section 4.3.3
9. Repeat the check that was referred to in the previous point 7

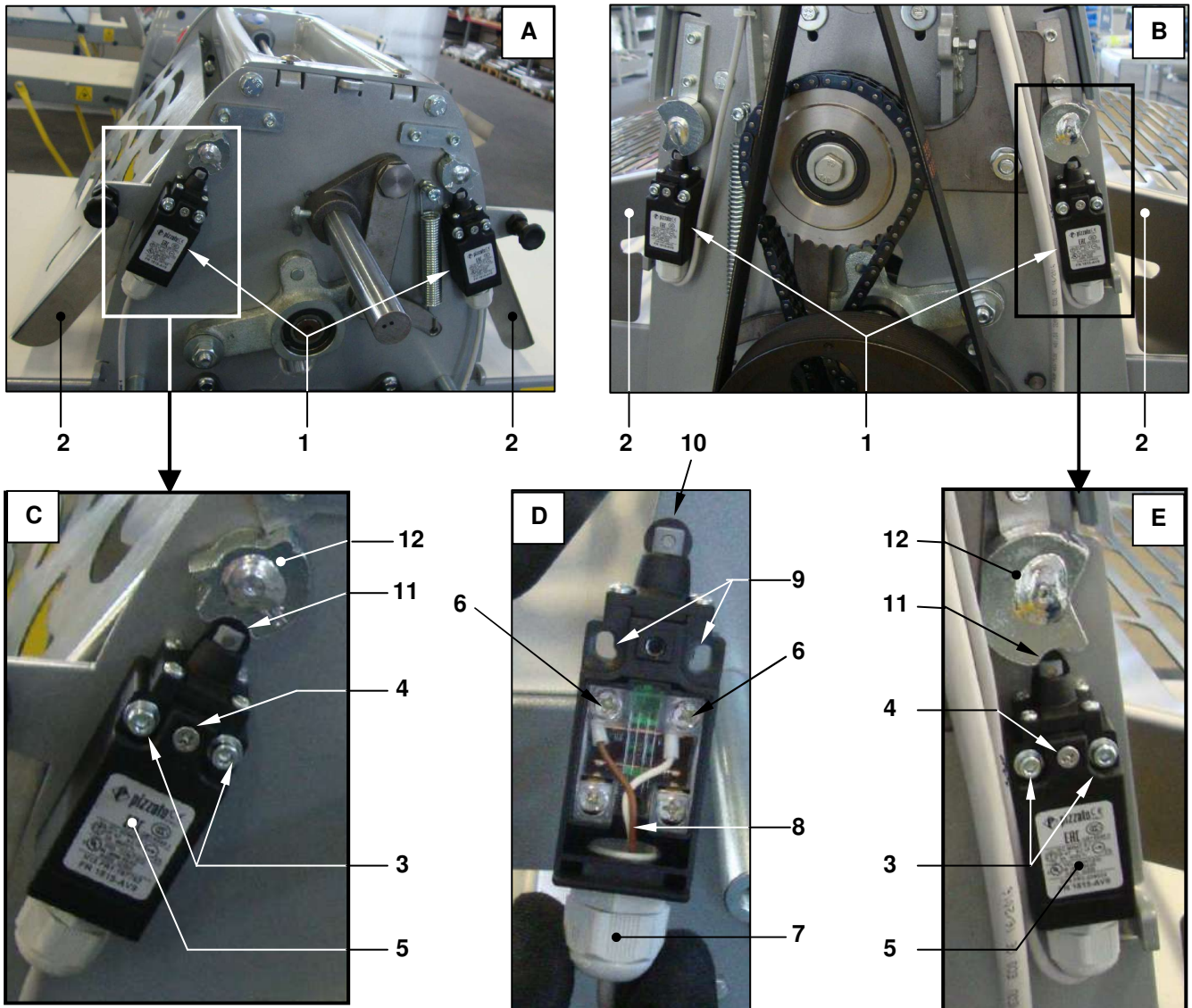

Figure 44 - Safety micro switches associated with the interlocked guards in the rolling zone

4.10 CLEANING

Before starting, take the safety precautions described in section 4.1

To ensure that the machine is hygienic: clean it at the end of each day and/or each shift.

The machine should be thoroughly cleaned **whenever you do not intend to use it for more than ten hours to avoid biological hazards** due to mould, bacteria etc. as well as to prevent the formation of deposits that are difficult to remove. Cleaning should be carried out as follows:

- make sure that nobody is in the vicinity of the machine
- raise interlocked guards completely (see section 3.5)

if necessary, remove the cutting unit and the relative rollers, which can be washed separately with warm water and a neutral dishwashing detergent, as long as they are well rinsed and thoroughly dried before they are reinstalled on the machine.

- remove the upper and lower scrapers (section 4.5). The scraper units can be washed separately in the same way and with the same precautions described in the previous point for the cutting unit and rollers.
- **wear safety footwear with reinforced toecaps, a dust mask** (which has a filtering capacity that is appropriate for the particle size of the flour. See section 3.11.1, part 8), **safety eyewear with side shields and waterproof gloves. Ventilate the room during and for at least 15 minutes after cleaning has been completed.** If possible, clean in an open or well-ventilated area.
- remove the under-table and central residue collection trays (section 3.8) and after removing any residues that have been collected, clean it with a damp cloth moistened with clean water.
- using a vacuum cleaner fitted with a narrow nozzle, removed deposits of flour and residues of dough from all parts of the machine. If necessary, remove the most stubborn residues using a plastic spatula and a brush with medium-hard synthetic bristles. Before using the vacuum cleaner, and **only when absolutely necessary**, use short blasts of compressed air to loosen residues from parts that are difficult to reach.
- using a brush with medium-hard synthetic bristles, remove or loosen any residues from the conveyor belts (if necessary and taking the safety precautions indicated above, using short blasts of compressed air), then use the vacuum cleaner to remove the residues.
- using damp cloths moistened with clean water, but not soaking, clean any surface that is in contact with or that can come in contact with foodstuffs. In particular the rollers, interlocked guards and internal uprights
- again, using clean cloths moistened with clean water (but not soaking), clean the other surfaces, including parts of the base under the conveyor belts, after having moved the latter into the upright position (section 3.6). Lastly, dry the surfaces well using clean cloths. **Be careful not to wet the control devices.**

Do not use metal objects to avoid damaging the parts. Do not use water jets/spray water.

Make sure that the machine is completely dry before using it. If it is not, deposits and encrustations may form, which in time may become difficult to remove.

4.11 POSSIBLE FAILURES AND / OR FAULTS

Here we indicate some possible failures and/or faults that may occur. Any action taken must be carried out in compliance with the instructions, if any, and in any case **only after having taken the safety precautions referred to in section 4.1.**

Failure and/or fault	Possible causes	Solutions
The machine does not turn on	<ul style="list-style-type: none"> • No power • Electrical protection device tripped (e.g. thermal switch) 	<ul style="list-style-type: none"> - Check that the plug is properly inserted, that the main power switch is in the I (ON) position and that the safety devices of the premises power supply have not tripped. Reset if necessary - Reset the safety device that has tripped (special/extraordinary maintenance)
The machine doesn't start	<ul style="list-style-type: none"> • An interlocked guard is not completely lowered • A micro switch associated with one of the guards is faulty 	<ul style="list-style-type: none"> - Lower the guard completely - Have it replaced (special/extraordinary maintenance). See section 4.9
There are folds and/or tears in the sheet of dough	<ul style="list-style-type: none"> • Conveyor speeds are not uniform • Rollers dirty 	<ul style="list-style-type: none"> - Check and if necessary, adjust the tension of the belt(s) - Clean the rollers and if necessary, clean or replace the scrapers. See section 4.10

4.12 SPARE PARTS

To order replacement parts, contact the manufacturer or the dealer from whom the machine was purchased. Provide a brief description of the part and/or its use and always specify serial number of the machine. For transmission belts and chains see section 4.3 and section 4.7 respectively.

4.13 PROLONGED STOP OR TAKING THE MACHINE OUT OF SERVICE

If the machine is not to be used for a long time or is to be taken out of service, disconnect it from the mains power supply.

Take it to a suitable place and clean it completely (see section 4.10). If necessary, place the tables in the upright position (see section 3.6) and cover the entire machine with waterproof sheets to protect it from atmospheric agents, dust, insects, rodents etc. Make sure that it is protected from impact and that it cannot be tampered with or damaged in any way etc.

When it is put back into service it should be inspected carefully to make sure that it is integral and you should proceed as if it was the first time it was put into service.

5 SAFETY

5.1 FOREWORD

The considerations referred to in this chapter are based on the assumption that:

- the customer/user and every operator assigned to the machine is/are fully aware of the conditions of use and the intended use of the machine that are envisaged and specified in this manual.
- the operators have been adequately informed and trained regarding risks in the workplace in compliance with, among other things, the law in force in the European Community
- access to the workplace is prohibited to unauthorized persons, untrained persons and children

5.2 HAZARDS, SAFETY DEVICES AND RESIDUAL RISKS

5.2.1 HAZARDS ASSOCIATED WITH THE MACHINE

With reference to Figure 45, the following hazards and relative risks are associated with the machine.

hazards of a mechanical nature:

- A. Trapping, dragging, crushing:** between the thickening rollers as well as between the thickening rollers and adjacent parts (uprights, scrapers), between the conveyor belt drive cylinders closest to the rolling zone and scrapers
- B. Trapping and dragging, entrapment, cutting, crushing:** between the drive components on both sides of the machine base
- C. Trapping and dragging, crushing:** in the zones where the conveyors and the drive cylinders/guide meet
- D. Crushing, cutting:** between the rollers of the cutting unit and the bench.

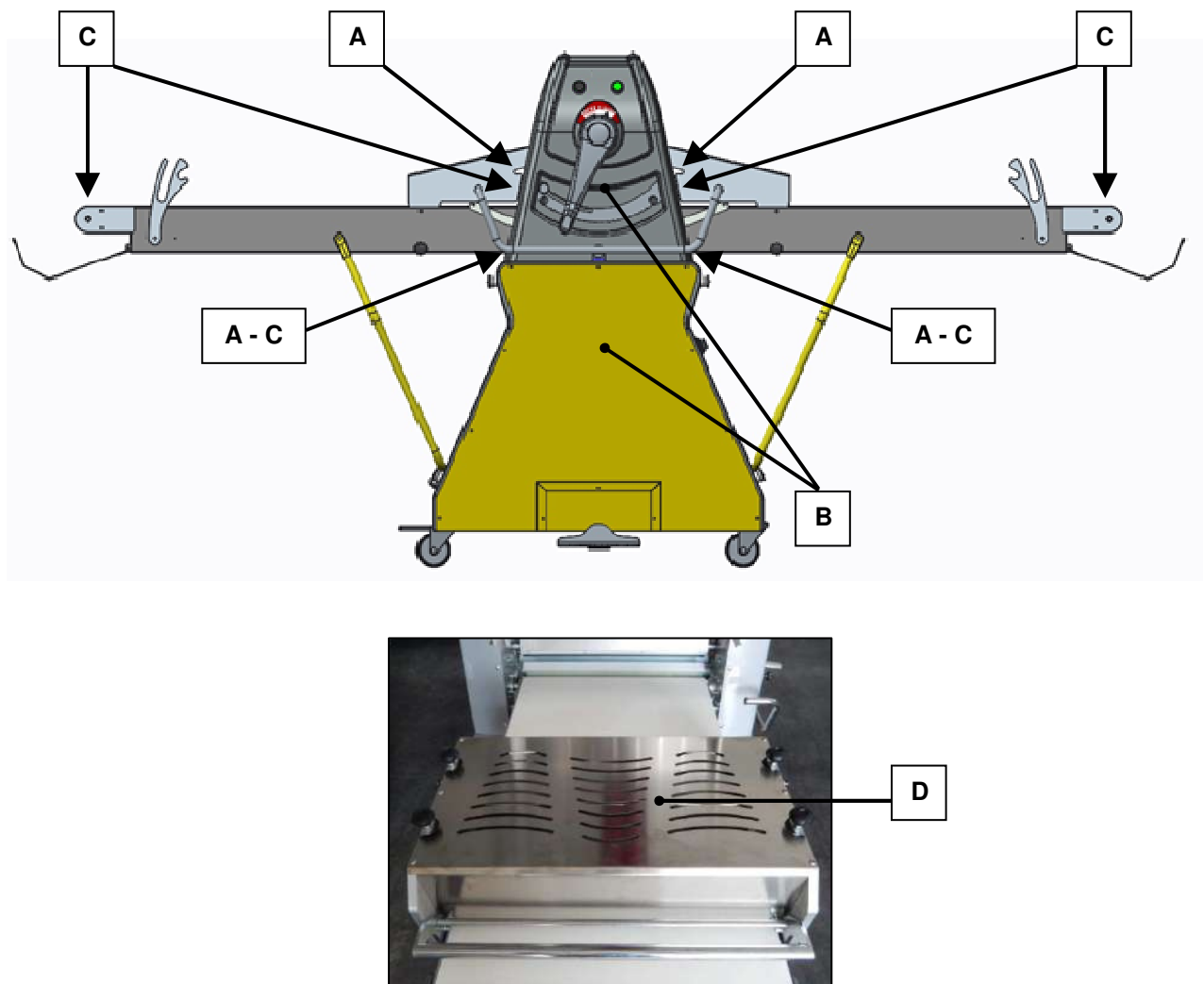

Figure 45 - Hazards of a mechanical nature

The following hazards and relative risks are also associated with the machine:

hazards of an electrical nature:

E. electrocution: by contact with live parts (for example, inside the electrical enclosure)

hazards associated with instability

F. tipping hazard (e.g. if moved with the tables fully raised)

associated with the machine being started accidentally

G. loss of balance and falling in the event that, with the machine already enabled for operation, a person were to lean on a conveyor belt and another person were to inadvertently press a start or reverse control (lever, joystick, pedal)

associated with hygiene

H. damage to people's health by contact with mould, perishable substances etc. due to the presence of insects rodents etc.

I. unacceptable alterations to the food product (for example contamination by micro-organisms or from foreign substances/matter)

associated with the failure to comply with ergonomic principles

J. bodily injury / harm as a result of incorrect posture and/or movement(s).

K. lifting and handling of heavy loads (manual handling of large quantities of dough, installation/removal/handling of tables and cutting unit etc.)

associated with inhaling dust

L. possible damage to the respiratory tract (rhinitis, lachrymation, asthma etc.), if the operator, when sprinkling the dough with flour fails to take the precautions outlined in this manual and causes large amounts of dust to be dispersed into the air.

The related risks have been eliminated or minimized as much as possible by adopting the safety measures and devices described in section 5.2.2, 5.2.3 and 5.3 and/or can be further reduced if the user takes the precautions indicated in section 5.2.3, 5.2.4 and 5.3.

5.2.2 MACHINE SAFETY DEVICES

- Interlocked mobile guards, each associated with a safety micro switch**, positioned in order to protect the rolling zones and, in general, the zones subject to the hazards indicated with the letter A in section 5.2.1. They can be lifted from one end as they are able to rotate about a horizontal pin. They consist of a steel plate in which slits have been made in to order to make the rolling area visible. If a guard is raised, the associated micro switch, which has normally closed contacts, if forced open (positive) causes all parts of the machine to stop. The micro-switch trips when a guard is lifted and the distance D between the edge of the guard and the conveyor belt (see Figure 46) exceeds a limit value **D_{max}**, which must not, under any circumstances be greater than:
 - 70 mm for models SF500 and SF600
 - 40 mm for model SF450
 The machine must stop within a second of the micro switch tripping. This requirement is verified by Flamic on the new machine before it is shipped. In order to restart the moving parts after the machine was stopped, first lower the guard and then press the enable button ref. 2 Figure 4.

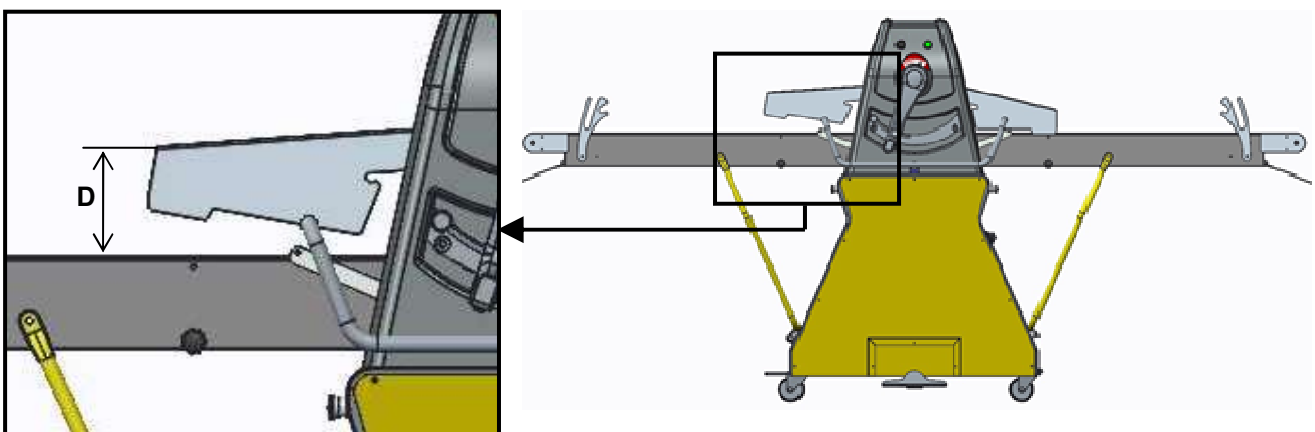

Figure 46 - Interlocked guards in front and behind the rolling zone

2. **Fixed guards:** These are guards that are secured by fastening devices which can only be removed by using tools. If properly installed and fixed to the support structure, they make it impossible to access, in particular (but not only), the drive mechanisms of the dough thickening rollers and the conveyor belt drive rollers. The main fixed guards of the machine are those indicated in ref. 1, ref. 2 (analogous guards are located in a similar position on the opposite side of the machine) and those in ref. 3 Figure 47. The C profiles ref. 7 Figure 47 that cover the whole length of the conveyor belt rollers (only those at the outer ends of the tables) are also considered to be fixed guards as well as any plates ref. 4 Figure 32. Their maximum distance from the conveyor belt and the roller, must not be greater than 4 mm. The base ref. 4 also prevents access to the transmission components and the uprights and guards ref. 5 act as fixed guards to prevent access to the thickening rollers from the sides and from above. Note also the importance of the cover ref. 6 of the cutting unit. Even if it is not actually a fixed guard (it doesn't need tools to remove it), it is as if it were because when the unit is locked in its working position and the working parts are moving, it is impossible to access them (in this condition the gap through which the sheet of dough passes is such as to prevent the hazardous components from being reached). As soon as the unit is released and raised, the rollers stop due to the lack of friction required to make them move.

WARNING!

Do not remove the guards and/or disable safety devices, unless it absolutely necessary to do so and after having adopted all possible measures to minimize the associated risks and only and exclusively with authorization of the employer, manager, person responsible etc.

Replace the guards and secure them with all the fastenings provided and **re-enable the safety devices** as soon as there is no longer any reason for them to be removed/disabled. Anyone who does not comply with the above will be held liable for any damage or injury, direct or indirect that may be caused to persons, animals or property.

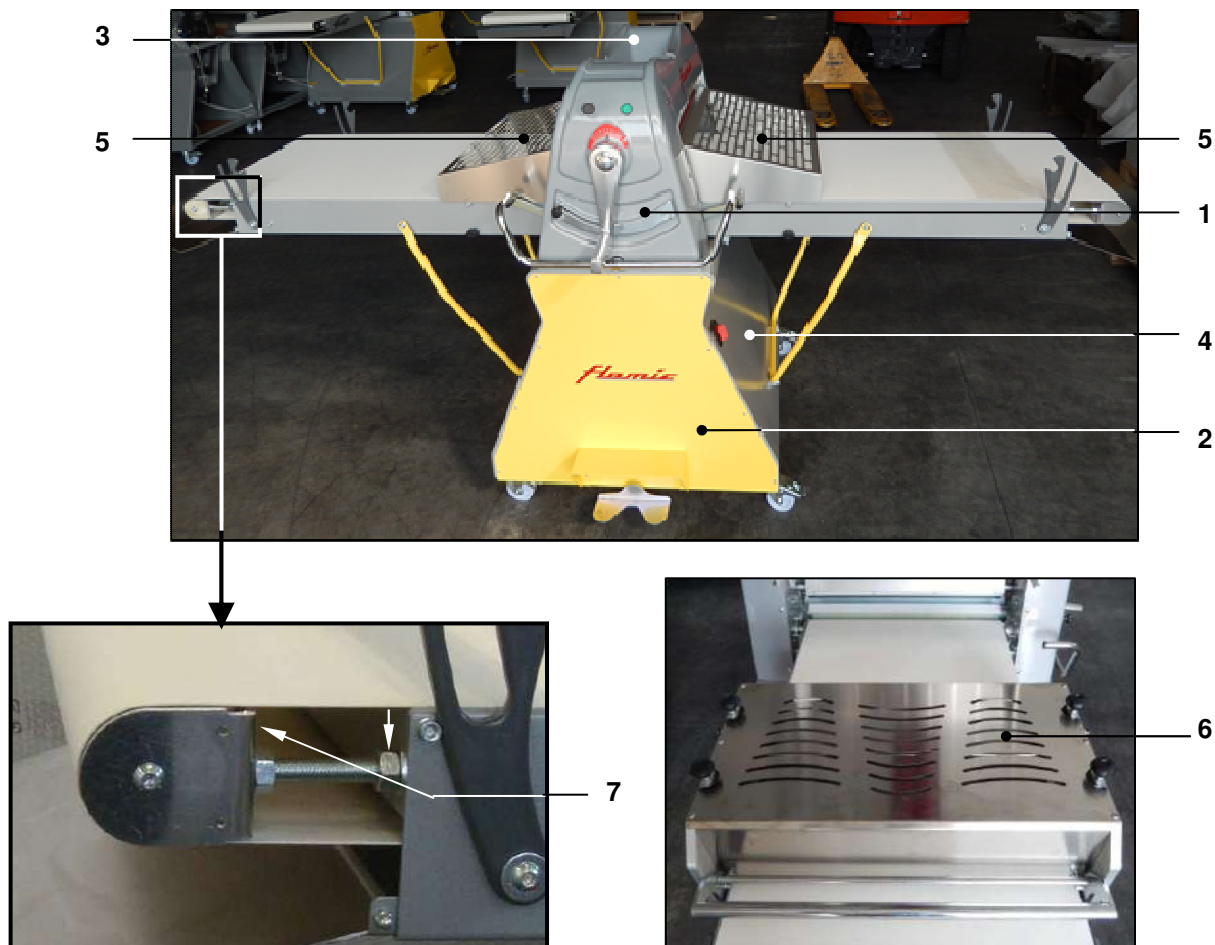

Figure 47 - Guards fastened with screws or similar means

5.2.3 CHECKING THE WORKING ORDER OF SAFETY EQUIPMENT

At the beginning of the working day and/or shift, test the working order and integrity of the safety equipment referred to in section 5.2.2:

1 Checking the interlocked mobile guards and relative safety micro switches.

Make sure that each guard is in perfect condition and that it is not dented or deformed.

Start the machine empty. When the machine is running, slowly lift one of the guards and stop as soon as you hear the click of the micro switch and the machine stops. Make sure that:

- the micro switch trips and stops all moving parts of the machine when the distance **D** between the edge of the guard and the conveyor belt underneath it (see Figure 46) does not exceed the D_{max} value indicated in section 5.2.2, point 1.
- every part stops within a second of hearing the click of the micro switch (use a stopwatch; in case of doubt the check should be carried out by a qualified electrician using suitable instruments, for example an oscilloscope).
- check that it is not possible to use the start controls if the micro switch has been tripped.

This test must be carried out separately for each guard.

In the event that the machine does not pass this test, do not use it and request the assistance of a specialized technician with experience in machine electrical systems. If necessary, contact the manufacturer.

2 Fixed guards

Visually check that they are all present and correctly positioned, in good condition (no deep dents, cracks etc.) and that they are secured with all the fixing devices provided.

In the event that the machine does not pass these tests, do not use it and request the assistance of a specialized mechanical technician experienced in machine assembly. If necessary, contact the manufacturer.

5.2.4 RESIDUAL RISKS

It is the responsibility of the employer to provide the operators with adequate information regarding the residual risks associated with the use of the machine, as well as training regarding its safe use, on precautions to be taken and on what not to do.

5.2.4.1 RESIDUAL RISKS OF A MECHANICAL NATURE

Risk of trapping, dragging and crushing between the parts mentioned in section 5.2.1, item A, and in particular between the thickening rollers. There is a possibility (even if very remote) that a person may be able to reach the danger zones concerned through the gap between guard and the conveyor belt before its safety micro switch trips and stops the machine.

Avoid any temptation to access the rollers through this gap. There is no reasonably foreseeable reason to do so and one would be exposed unnecessarily to serious risks to his/her safety.

There would be a similar risk if you were to raise a guard and with a quick movement of the arm attempt to reach the dangerous components (in particular the thickening rollers). The maximum permitted stopping time is one second and as already mentioned, this requirement is verified by Flamic on the new machine before it is shipped. However, this time limit does not totally rule out the possibility that the dangerous parts cannot be reached before they come to a stop.

For this reason, **it is strictly prohibited and without exception even to attempt to reach the hazardous moving parts**, even whilst they are stopping.

Risk of trapping, dragging and crushing between the lower roller and lower scrapers, in the event that someone were to attempt to reach them from underneath the benches. The risk is very low because there is no reasonably foreseeable reason why anyone would want to place their hands in the danger zone from underneath the tables. If, however, for any reason it is necessary to do so, the machine must be switched off beforehand (turn main power switch to O - OFF) and remove the plug from the power outlet (leave it in a clearly visible position, as already mentioned several times).

Risk of trapping, dragging and crushing between the parts mentioned in section 5.2.1, item C. A minimal residual risk remains due to the fact that the conveyor belt is not rigid and it is anyway possible to insert your fingers into the danger zone. To reduce the risk further, **avoid placing your hands close to the sides** of the conveyor rollers. In addition, **wear only tight-fitting clothes**, without loose parts. Never wear jackets, open shirts etc. or jewellery (rings, bracelets, necklaces, etc.) to avoid them becoming trapped between the roller and the conveyor belt. Long hair should be collected (e.g. in a cap).

5.2.4.2 RESIDUAL RISKS DUE TO THE MACHINE TIPPING OVER

Risk of crushing and severe bruising if the machine were to tip over.

Although the machine has successfully passed the required stability tests, a residual tipping risk remains whilst it is being moved on its wheels. To further reduce this risk, one must make sure that there are no obstacles along the route that the machine will take that could cause the machine to become unstable, tip and fall over. This applies especially when the benches are in the raised position because the centre of gravity is significantly higher than when the benches are in the working position.

We remind you that you should not move the machine on its wheels with the tables folded.

5.2.4.3 RESIDUAL RISKS ASSOCIATED WITH THE MACHINE STARTING UNEXPECTEDLY

Risk of loss of balance and falling if the machine is accidentally started.

This is a very remote risk, but nevertheless it exists and as such deserves appropriate attention.

It could happen only if the following conditions were to occur at the same time:

- machine enabled (after pressing button ref. 2 Figure 4)
- a person is next to the control devices
- a second person is leaning on one of the tables

If the person next to the controls were to inadvertently actuate a start or reverse movement control ref. 10 or ref. 11 Figure 1 (lever, joystick, pedals), the person leaning on the table would tend to move with the conveyor belt, become unstable, lose his/her balance and could fall over. In order to reduce or even eliminate the risk, never leave the machine unattended for any reason when it is enabled and ready to start and do not enable it if there are other people close by. If other people get close to the machine when it is in operation, immediately press the button ref. 3 Figure 4

5.2.4.4 RESIDUAL RISKS DUE TO INHALING DUST

Refer to what was written regarding this in sections 3.11.1 points 7 - 8 and section 4.10

5.2.4.5 RESIDUAL RISKS DUE TO POOR HYGIENE

This risk can exist only if the daily cleaning of the machine is not carried out correctly in accordance with the instructions provided in this manual, especially in section 4.10.

The poorer the hygiene, the higher the risk

If necessary, replace those parts of the machine intended to come into contact with food products. It is very important that these parts be supplied by Flamic s.r.l, or authorised dealers.

5.2.4.6 RESIDUAL RISKS ASSOCIATED WITH ERGONOMICS

Risk of musculoskeletal injuries. Refer to what was written regarding this in sections 3.4 - 3.6 - 3.10 - 3.11.1, point 6 - 3.11.4 and in chapter 4 (particularly in section 4.6).

5.2.4.7 RESIDUAL RISKS OF AN ELECTRICAL ORIGIN

Appropriate hazard warning signs have been placed on the cover of the electrical enclosure and any other enclosure containing live parts having a voltage of ≥ 24 V (see section 5.3). The risk is mainly associated with the accidental contact (impossible under normal conditions) with live parts during maintenance work. As stated several times, **it is mandatory to turn off the main power switch**, by turning it to O - OFF, and **to remove the plug from the power socket before carrying out any work.**

The plug must remain clearly visible so that anyone can check to make sure that the machine is not powered.

WARNING FOR MODEL "V" MACHINES FITTED WITH AN INVERTER

After having switched off and isolated the power supply, there is a residual voltage in the inverter that could pose a serious safety hazard for persons that come into contact with parts still powered by this voltage. Section The display and the LEDs on the inverter will remain on until the voltage of the DC BUS (and therefore the relative capacitors) drops below 60 Vdc, after which they will switch off to indicate that the residual voltage should have decreased to non hazardous levels.

WARNING!

In any case, once the power supply has been switched off and isolated, before touching or working on parts of the inverter or its electrical terminations or parts connected to them, it is mandatory to:

- **wait at least 10 minutes after the inverter display and LEDs have turned off**
- **using suitable instruments, check that there is no voltage on the terminals of the motor.**

We repeat that **all work of an electrical nature must only be carried out by experienced and professionally trained personnel**, who are able to carry out the work in a workmanlike manner and who possess the technical and regulatory knowledge to carry out the work properly and safely.

5.2.5 MACHINE NOISE LEVELS

Noise levels were measured on a model SF600 + ST600 machine, with the cutting unit installed and functioning. Test conditions (in accordance with the provisions of harmonized standard EN 1674:2015, Annex B):

- machine running empty at maximum speed, with the reversal of conveyor belts at approximately regular intervals to simulate actual operating conditions, but without a pause between one reversal and another (i.e. under more severe conditions than those that might occur during normal use)
- microphone positioned at 1.6 m from the floor
- distance of the microphone from the external surface of the parallelepiped envelope of the machine:
 - 1000 mm ± 20 mm for points 1 - 2 - 3 - 4
 - 200 mm ± 20 mm for point 5 (position in front of the controls)
- background noise of LAeq = 39.2 dB[A]
- duration of each measurement: approximately 30 seconds (not less)

The measurements were taken with a Class 1 integrating sound level meter

The following table shows the LAeq values (A-weighted sound pressure level) that were measured. Figure 48 shows the position of the points at which the measurements were taken.

The maximum error of the measurements is estimated to be in the order of 2 dB[A].

In the light of the values measured on the machine specified above and considering the great similarity between the different versions of the machine, the A-weighted sound pressure level, LAeq, can reasonably be considered to be less than 70 dB[A] for all the dough sheeters mentioned in this manual.

Measurement point	LAeq (dBA)
1	66.3
2	63.2
3	64.8
4	63.3
5	68.9

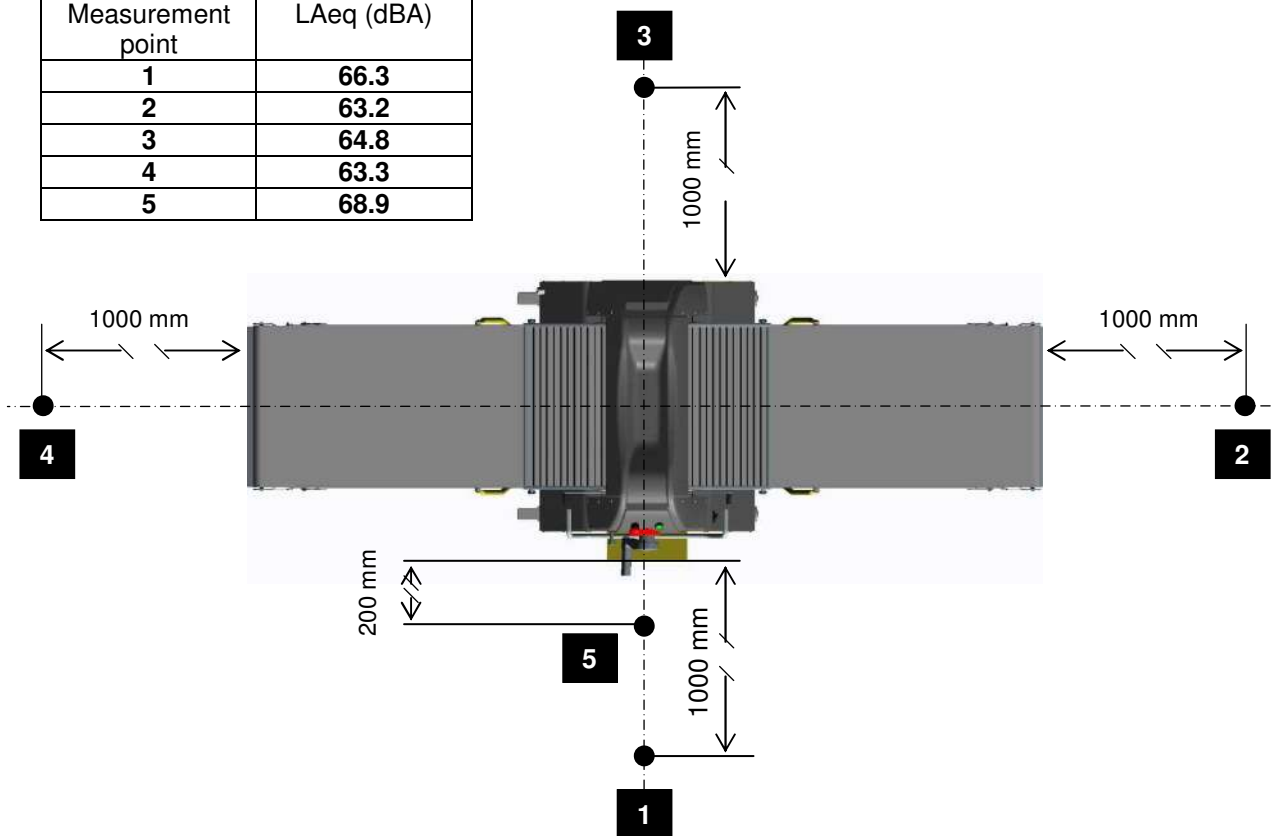





Figure 48 - Sound level measurement points

5.3 SAFETY SIGNS

The following safety signs are fixed to the machine:

Check the condition of the images and the colours of the signs. Replace them as soon as they begin to show the slightest sign of deterioration.

	Electrocution hazard (electric shock) <i>on the outside of each enclosure containing live electrical components > 24 V</i>
	WARNING! Trapping, dragging and crushing of hands hazard <i>(on both edges of the tables next to the danger zones A and C. See section 5.2.1)</i>
	Do not remove the safety guards and/or disable the safety devices <i>(on the upper part of the fixed side guards on the uprights)</i>
	Do not clean, lubricate etc. moving parts of the machine when in motion <i>(on the upper part of the fixed side guards on the uprights)</i>

6 DISPOSAL

If you wish to scrap the machine, separate the various components according to the type of material they are made of and then dispose of them in compliance with current laws and regulations. The most important items are listed below:

Stainless steel:	catch pan, interlocked guards
Steel:	pinions, crown gears, chains
Painted steel:	support structure, table frames, residue collection trays (apart from SF450), lower casing of the base.
Chrome steel:	rollers
Burnished steel:	drive pulley
Aluminium alloy:	rolling pin rolls
Cast iron:	levers, pulleys other than the drive pulley, bushes
Plastic:	casing on the sides of the uprights and above the rolling zone, conveyor belts, the scraper blade, spacers, rolling pin hand grips, buttons, electrical enclosure
Rubber:	drive belts
Various materials:	motor (copper windings), cables (copper conductor, electrical and electronic components)

The parts contaminated with lubricants (e.g. gears, chains, bearings) should be disposed of separately. Use companies specialized in waste disposal in conformity with applicable laws.