

# MAR 109

## Modular Ice Machine 648 kg

Item #:
Project:
Quantity:



### FEATURES

- Scale ice machine, in split system" version; built-in unit. Storage bin not supplied, to be purchased separately.
- To be connected to condensing unit or central cooling system (low temperature).
- AISI304 Stainless steel evaporator and ice scraper blade. Redesigned evaporator compartment end-walls.
- Foodgrade ABS plastic water sump tray, easy remove for cleaning and sanitising.
- Electromechanical control panel. Electrical protections, rotation speed & reverse phase controls.
- Low- water sensor protection. Storage bin thermostatic ice level sensor. Drive motor / gear reducer with V-Belt drive.
- Stainless steel panels in scotch-brite finish, with rounded corners, easy to remove for maintenance.
- Supplied w/ electronic expansion valve, pressure regulating valve (KVR), liquid line safety valve 60bar, suction line safety valve 30bar.



MAR 109  
Scale ice  
Residual water content 2%  
Thickness 2 mm

### CONDENSING SYSTEM

SPLIT





### REFRIGERANT GAS

R744



### VOLTAGE V/Hz/ph

400/50/3N

### RECOMMENDED BINS

Head	Bins		kg
MAR 109		<b>UBH1100</b>	553
		<b>UBH1600</b>	812
		<b>UBH2250</b>	1068
		<b>SIS700</b>	318 + 73
		<b>SIS1350</b>	613 + 73 + 73

#### LEGEND:

-  : Perfect combination between ice maker and bin
-  : Ice chute cut-out performed upon installation
- CBTxxxxxxxx : need additional bin top

### CERTIFICATIONS



### OPERATING REQUIREMENTS

	Minimum	Maximum
Air temperature	10	43
Water temperature	5	38
Water pressure	1 bar (14 psi)	5 bar (70 psi)
Electrical voltage	-10	+10

**IMPORTANT NOTICE:**  
Models and specifications are subject to change without notice.  
This spec sheet is meant for commercial purpose only.  
For technical documentation please refer to our service manuals.

Download our free **App Scotsman Ice**  
Apple store  
Google play  
Windows store



[www.scotsman-ice.it](http://www.scotsman-ice.it)  
[www.scotsman-ice.com](http://www.scotsman-ice.com)

Modular Ice Machine 648 kg

# MAR 109 **EcoX**

## Modular Ice Machine 648 kg

Item #:
Project:
Quantity:

Modular Ice Machine 648 kg

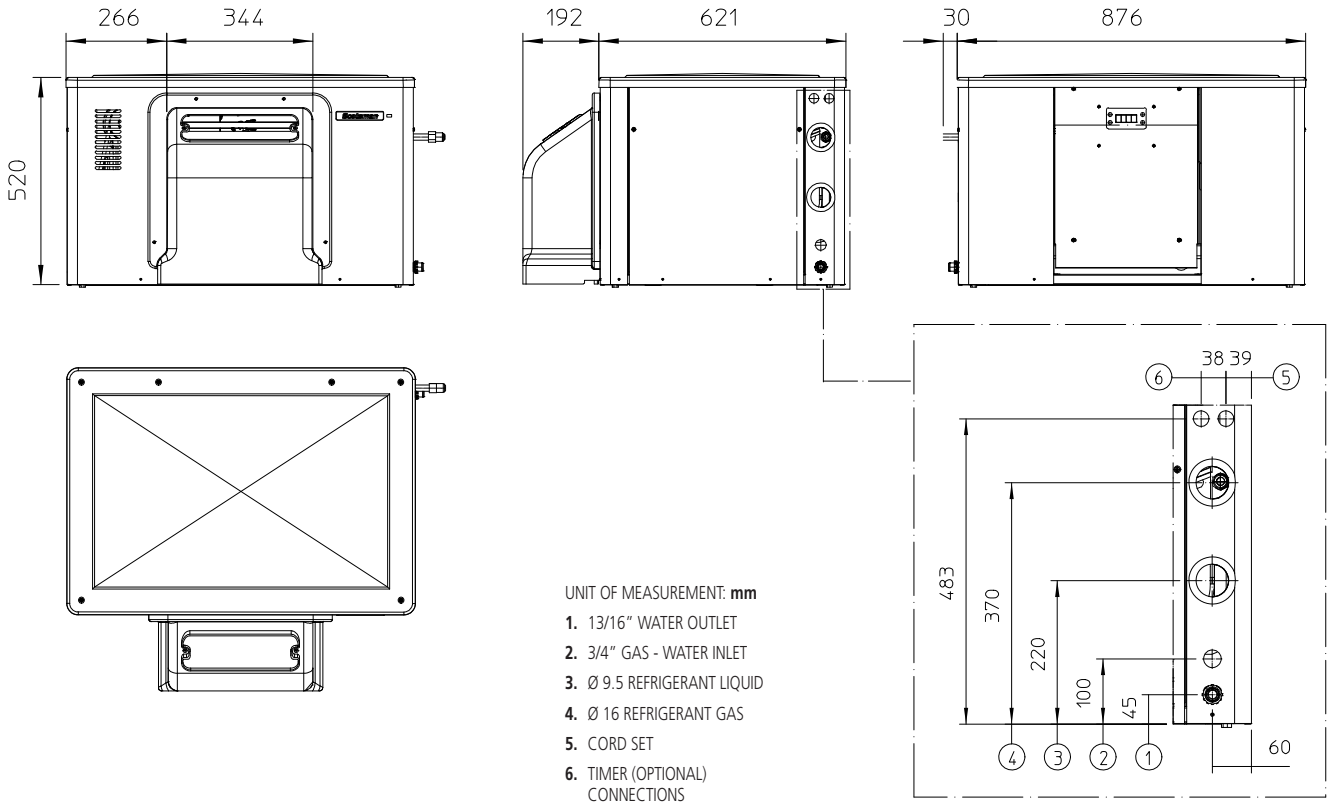

UNIT DATA		SHIPPING DATA									
Size (W x D x H)	906 x 813 x 520 mm	Carton (W x D x H)	980 x 740 x 680 mm								
Net weight	95 kg	Weight	112 kg								
		24 h ice production kg °C Amb. / °C Water			Energy consumption (*)		Water usage (*)	Instant power	Compressor	Circuit wires	Max. fuse size
Version	Voltage	10°C/10°C	21°C/10°C	32°C/21°C	kWh/100 kg	kWh/24h	l/h	W	W	No. x Ømm²	A
MAR 109 SPLIT	400/50/3N	648	648	504	0.8	4.2	23.3	190	4000	5 x 1.5	10
Compressor:	(Te -25.0°C; Tc +10.0°C)										

(\*) Data refer to 32°C Amb. / 21°C Water temperature conditions