



VEGETABLE DRYING MACHINE (ELECTRICAL – INDUSTRIAL TYPE)

USER'S MANUAL



AUTHORIZED DEALER
SERVICE STICKER WILL
BE ATTACHED HERE.



PRODUCTION YEAR:

SERIAL NO :



TSEK



MANUFACTURER : ÖZTİRYAKİLER MADENİ EŞYA SAN. VE TİC A.Ş.

PRODUCTION SITE : Beylikdüzü Eski Hadımköy Yolu 1.Km Büyükçekmece İstanbul/TÜRKİYE
Phone : 0090 212 886 78 00 (8 Hat-Lines) Fax : 0090 212 886 66 29

Our website: www.oztiryakiler.com

e-mail: export@oztiryakiler.com.tr

TABLE OF CONTENTS

PAGE NR.	TOPICS
1	COVER PAGE
2	TABLE OF CONTENTS
3	INTRODUCTION
4	TECHNICAL DATA
5	ELECTRICAL CIRCUIT DIAGRAM,CONTROL BOARDS
6 - 7	MAIN DIMENSIONS AND WARNING SIGNS
8	SAFETY DETAILS
9	TRANSPORTING AND MOVING
10	INSTALLATION OF THE APPLIANCE
11-12	OPERATION OF THE APPLIANCE
13	CLEAN-UP AND MAINTENANCE
14	TERMS OF WARRANTY



CAUTION

The power network of the building, facility or any similar site, where this device will be connected to power supply, should comply with “INDOOR ELECTRICAL INSTALLATION” regulation all necessary action should be taken in order to maintain personal and material safety when connecting this device to power supply. OTHERWISE OUR COMPANY WILL NOT BE RESPONSIBLE FOR THE CONSEQUENCES.

INTRODUCTION

Dear User,

Thank you for purchasing our appliance and for your reliance upon our company. Our appliances are used in professional kitchens in 100 countries. Our appliances are produced in compliance with international standards. Important notice: Please read and ensure that the users read this user's manual in order to achieve the desired performance in line with your expectations and to use your appliance for long years. Please take the warnings mentioned above into consideration before calling for service...

 Please read and ensure that your operation personnel also reads this user's manual carefully before installing and using the appliance. If the appliance is operated without reading the user's manual, the appliance will not be covered by the warranty.

 The manual containing information about installation, usage and maintenance of our product you purchased should be read carefully. Please ensure that power supply connections to the appliance are already installed by qualified personnel according to local legislation, before our authorized service personnel arrives for the installation of the appliance.

 If you are confused or you don't have enough information please get in touch with authorized service by phone.

 Please keep in mind that, if the service personnel is delayed at your site, related expenses and delay costs will be charged to you on hourly basis.



 We hope that you will get the best performance from our product...

TECHNICAL DATA

YOUR PRODUCT'S TYPE	SKM 4035
MAIN DIMENSIONS (mm)	510x750x1100
TOTAL ELECTRICAL INPUT (kW)	0,55
POWER SUPPLY VOLTAGE	400 V
OPERATIONAL CAPACITY (KG/BATCH)	40
WORKING FREQUENCY (Hz)	50-60
NOMINAL CURRENT (A)	1,6
SUPPLY CABLE	3X2,5
MAXIMUM NOISE (dBA)	73
MAXIMUM SLOPE	5°
PROTECTION CLASS	1
CLASS	IP54
WATER OUTLET (inch)	1 1/2"
NET WEIGHT (Kg)	57

ELECTRICAL CIRCUIT DIAGRAM

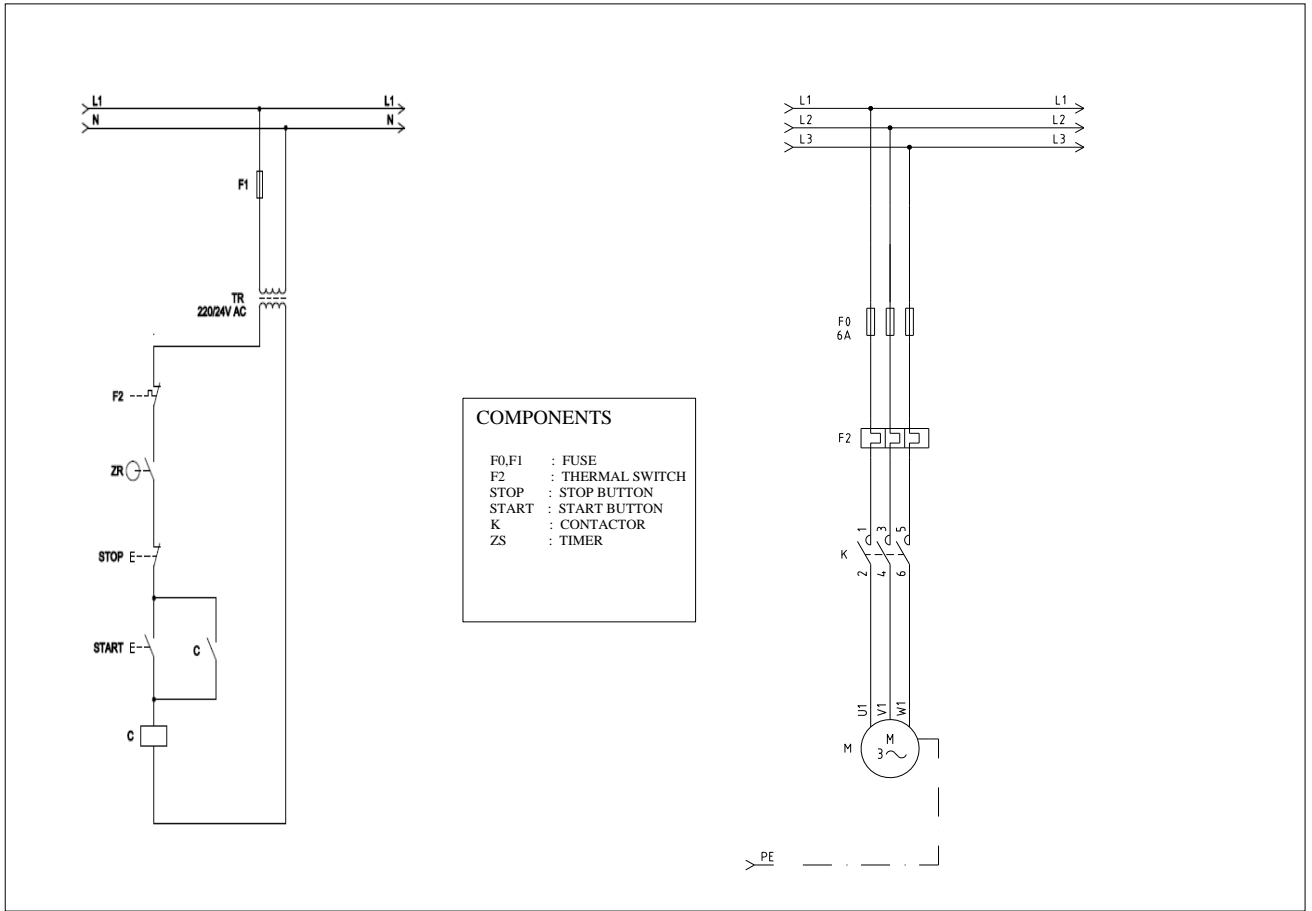

NOTE: Valid for every model.

CONTROL BOARDS

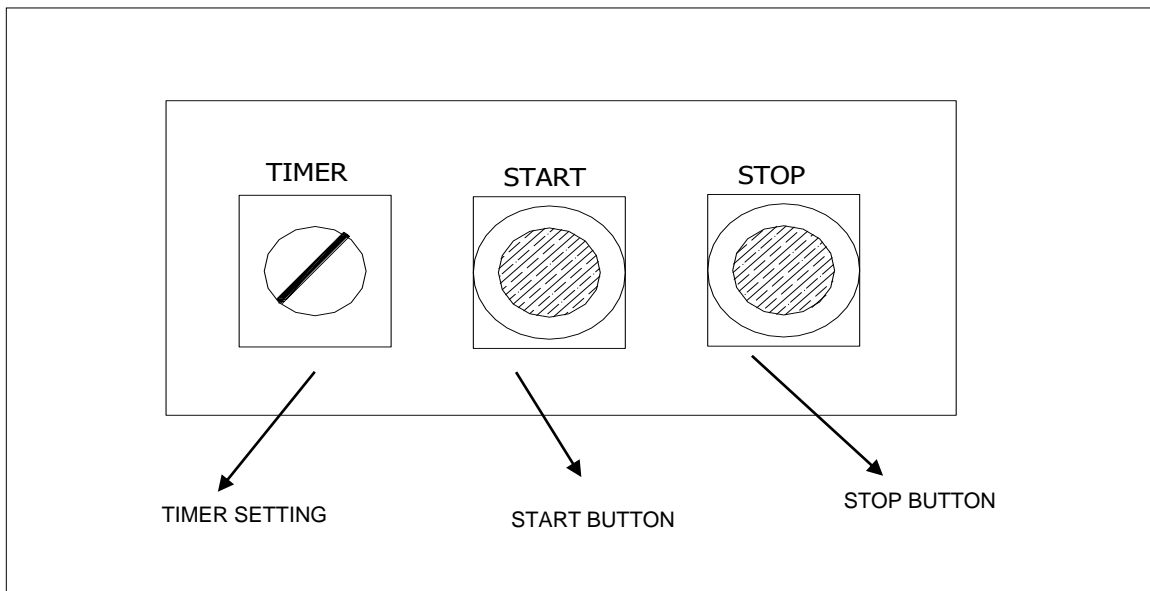

MAIN DIMENSIONS



DIMENSIONS: 510x750x1100 mm.

WARNING SIGNS



POWER NETWORK GROUNDING



PE

GROUNDING



POWER

<p>POWER SUPPLY CONNECTIONS 220-240 V NPE / 50/60 Hz VOLTAGE : 220-240 V</p>
<p>SUPPLY CONNECTION: MONOPHASE</p>
<p>400 V 3 NPE / 50/60 Hz VOLTAGE : 400 V SUPPLY CONNECTION: TRIPHASE GROUNDED FREQUENCY : 50/60 Hz</p>

SAFETY DETAILS

☞ Do not clean up the device with pressure water

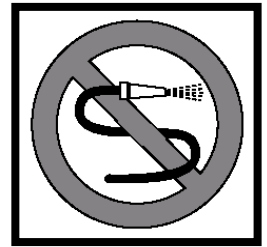

☞ This device should be installed in line with effective regulations and only be operated in well ventilated places. Please refer to the instructions before installing and operating the device.



☞ This device is designed for industrial use and should only be operated by personnel trained on the device.



☞ The device should not be handled by unauthorized persons except for the manufacturer or authorized service.



☞ In case of fire or flame in the area where the device is operated, act without panic, close gas valves (if any) , turn off the power switches and use a fire extinguisher. Never use water to extinguish the fire.



TRANSPORTING AND MOVING



CHANGING THE LOCATION;
Machines installed by an authorized service
**CANNOT BE MOVED ELSEWHERE, ITS POWER SUPPLY
CABLES CANNOT BE EXTENDED OR REPLACED** except
by an authorized service.

- ☞ Disconnect from power supply before moving
- ☞ The vehicle can be moved with supplementary vehicles like fork lift.
- ☞ The device should be placed on a palette by manpower.
- ☞ If the transported distance is far, the machine should be moved slowly and the device should be fixed on palette or supported in order to prevent jolt.
- ☞ Do not hit or drop the device when moving.

INSTALLATION OF THE APPLIANCE



Installation of the device should be carried out by authorized service personnel.

- ☞ Power supply connection of the device should be checked by an eligible electrician, and it should be connected to a fuse at a maximum height of 170 cm.
- ☞ Fix the three feet of the machine to the floor with three metallic fastening screws (M10x150).
- ☞ Power supply connection should be made using a 30 mA current leakage fuse as a protection against current leakage danger.
- ☞ Power installation to be used should be grounded by connecting it to a grounding bar at the nearest panel. Relevant fuse values to be used according to device power are given in Technical Data section (Page 4).

OPERATION OF THE APPLIANCE

PURPOSE OF USE AND USAGE

This product is used only in tourism facilities, industrial kitchens, catering companies for drying vegetables.

DRYING VEGETABLES AND FRUITS:

- 1- After placing the device packed into the location where it will be operated, take the device carefully out of its package.
- 2-Before first use, entire outer surface and inner kettle of the device must be cleaned up with liquid detergent and than rinsed with plenty of water.
- 3- Put washed vegetables and fruits into the drying basket and close the cover.
- 4-Select drying time.(5-10 second is enough)
- 5- Push the start button.Machine will start to dry the vegetables.After drying time finish the machine will stop automatically.
- 6-Open the cover of the machine and take out the drying basket. Emty the vegetables.
- 7-By intensive use, the device should be paused for a half hour, after 3 hours operation.



CAUTION !
**NEVER OPERATE YOUR DEVICE
WITHOUT GROUND CONNECTION.**

NOTE: Do not use except purpose of use. The device should be operated by qualified personnel knowing safety terms and technical specifications and who has read the instruction manual.



It is recommended to operate the device between temperatures of -5°C $+40^{\circ}\text{C}$ and in ambient humidity of maximum 65%.

OPERATION OF THE APPLIANCE



CAUTION! : The device should be installed and operated as described in this user's manual. If any failure is encountered please contact our nearest authorized service dealer.

WHEN THE DEVICE HAS A FAILURE ONLY AUTHORIZED
..... SERVICE DEALERS ARE ALLOWED TO HANDLE
THE DEVICE. IF ANY PERSON OTHER THAN ONLY
AUTHORIZED SERVICE DEALERS HANDLE THE DEVICE,
IT WILL NOT BE COVERED BY THE WARRANTY.

NEVER ALLOW PEOPLE WHO ARE NOT AUTHORIZED TO
HANDLE THE DEVICE. OTHERWISE PRODUCER
COMPANY WILL NOT BE RESPONSIBLE FOR THE
CONSEQUENCES. DURING MAINTENANCE SERVICE OUR
AUTHORIZED SERVICE DEALERS SHOULD NOT BE
PROPOSED TO USE NON-ORIGINAL SPARE PARTS FOR
WHATSOEVER. INSTALLING ANY NON-ORIGINAL SPARE
PART TO THE DEVICE LEAVES THE DEVICE
OUT OF WARRANTY COVERAGE.



CLEAN-UP AND MAINTENANCE

1. CLEAN-UP:

Turn the device off after daily use. Wipe the outer surface of the mixing apparatus and container with a sponge and liquid detergent. Top hood may be opened, to remove the peeler disc and to discharge rests left inside the vessel with help of water.

After clean-up with sponge and liquid detergent mixing apparatus and container should be rinsed thoroughly with plenty of water.

Do not use **CHEMICAL CLEANING AGENTS** like hydrochloric acid and abrasive materials during cleaning.

2. CLEAN-UP:

Periodic maintenance should be carried out by a technician. It is recommended to carry out maintenance at least every 6 months, depending on the frequency of use. Periodic maintenance conducted by authorized service personnel of ours is charged, even the guarantee period has not expired.

LIFE OF USE

Devices life of use is 10 year if it is used under recommended conditions.

TERMS OF WARRANTY

- 1- Documents without sales date, factory and sales company approval on, are not valid. In order to benefit from the warranty, warranty document should be presented.
- 2- If the appliance is installed and operated following the instructions in the installation, maintenance and user's manual, it is warranted for failures sourcing from materials and workmanship .
- 3- The failures within the scope of warranty, how and where these will be eliminated, and the way and place of maintenance is determined by
- 4- The warranty is only valid provided that the warranty terms and the instructions in the installation, maintenance and user's manual are fully complied with. The warranty is only valid for the warranted appliance, and no other right or compensation for some other thing may be claimed.
- 5- If the information about the kind and the type of the appliance, serial numbers printed on the warranty document are scraped, rubbed or changed, then the warranty is not valid.
- 6- The warranty covers only maintenance and repairing of material or workmanship failure within the valid warranty period. Failures and parts within the scope of the warranty are repaired and replaced without any charge. Replaced parts belong to
- 7- The failures occurring in the appliance may only be handled by service personnel authorized by If people who are not authorized handle the appliance, it will not be covered by the warranty.
- 8- Installation should be carried out by authorized service personnel and the service should be informed about the location change of the appliance.
- 9- When any failure occurs during operation, authorized service dealer should be contacted.
- 10- Warranty does not cover failures and damages resulting from loading, unloading and shipping, which are outside the responsibility of Similarly, failures and damages resulting from external factors are not covered.