

SANTOS SAS:

140-150 AVENUE ROGER SALENGRO
69120 VAULX-EN-VELIN (LYON) - FRANCE
TEL. 33 (0) 472 37 35 29 - FAX 33 (0) 478 26 58 21
Email:santos@santos.fr www.santos.fr



“KAWA” COFFEE GRINDER NO. 76

OPERATING & SERVICING MANUAL



IMPORTANT: documents contained in this manual and to be kept:

- "EC" DECLARATION OF CONFORMITY
- WARRANTY CERTIFICATE

ENGLISH VERSION



Coffee grinders - Fruit presses - Mixers - Blenders - Drinks dispensers - Mixer-blenders - Dough mixers - Cheese graters - Ice crushers - Meat mincers - Vegetable cutters

INTERNATIONALLY PATENTED MODELS

CONTENTS

"EC/EU" DECLARATION OF CONFORMITY 3

SAFETY RULES 4

INSTALLATION - HANDLING 4

RESTRICTIONS: 4

ELECTRICAL CONNECTION: 5

1st USE 5

END-OF-LIFE PRODUCT RECYCLING 6

YOUR COFFEE GRINDER NO. 76..... 6

USING THE APPLIANCE 6

FIRST USE: 6

USE: 6

 Grind setting: 7

CLEANING: 7

SERVICING 7

 Spare parts: 7

 Replacing burrs: 8

TROUBLESHOOTING ASSISTANCE 9

 The appliance does not start: 9

 The appliance stops because the motor has overheated: (the motor unit is hot) 9

 The appliance stops following an overload: 9

 The appliance runs without filling the portafilter 10

TECHNICAL SPECIFICATIONS OF THE APPLIANCE 10

TECHNICAL SPECIFICATIONS 10

Electrical diagram 110-120V 50/60Hz and 220-240V 50/60Hz 11

Correlation table 12

WARRANTY CERTIFICATE..... 14

APPLIANCE MANUFACTURER’S PLATE..... 14



"EC/EU" DECLARATION OF CONFORMITY

THE MANUFACTURER:

SANTOS SAS - 140-150, Av. Roger SALENGRO 69120 VAULX-EN-VELIN (LYON) FRANCE

Declares that the appliance to be launched on the professional market, hereinafter:

Designation: **"Kawa" coffee grinder**
Type Number: **76**

is in compliance:

- with the regulations defined by appendix 1 of the EU "Machinery" Directive **No. 2006/42/EC** and with national implementing legislation.
- with the regulatory provisions of the following European directives and regulations:
 - No. 2014/35/EU (Low Voltage Directive)
 - No. 2014/30/EU (EMC Directive)
 - No. 2014/65/EU (RoHS Directive)
 - No. 2012/19/EU (WEEE Directive)
 - No. 1935/2004/EC (Regulation) concerning materials and articles intended to come into contact with foodstuffs
 - No. 10/2011/EU (Regulation) concerning plastics intended for contact with foodstuffs

Harmonised European standards used to give presumption of conformity with the essential requirements of the directives mentioned above:

- NF EN ISO 12100:2010, Machine safety - General design principles
- NF EN 60204-1:2018, Machine safety – Electrical equipment of machines – General requirements
- NF EN 1672-2:2020, Food products machinery - Fundamental concepts - Hygiene requirements.
- NF EN 60335-1:2013, Safety of household electrical appliances and similar appliances
- NF EN 60335-2-64:2004, Particular requirements for commercial electric kitchen machines

Issued in VAULX-EN-VELIN on: **01/06/2024**

Title of signatory: **PRESIDENT AND CHIEF EXECUTIVE OFFICER**

Name of signatory: **Aurélien FOUQUET**

Signature:



SAFETY RULES

When using, servicing or disposing of the appliance, always observe the following basic precautions.

Read the complete user manual

Note: To facilitate the understanding of the following paragraphs, refer to the diagrams at the end of this manual.

INSTALLATION - HANDLING

Only one person is required for handling the appliance. For ease of use, we recommend placing the appliance on a table or work surface, so as to have the control panel in front of you (recommended height: 90 cm, to be adapted depending on the user).

RESTRICTIONS:



1. The appliance is not intended for continuous operation (maximum range of use: 5 seconds on and 90 seconds off).
2. Do not use this appliance to grind anything other than roasted coffee beans.
3. Never let the appliance run without coffee beans in the coffee bean hopper.
4. Remove all foreign bodies from the coffee beans (metal clips, stones, etc.) that can destroy the burrs.
5. To protect against the risk of electrocution, do not immerse the base in water or any other liquid.
6. The appliance must not be cleaned with a water jet, water under pressure or steam.
7. Never touch the moving parts.
8. It is prohibited to operate the appliance on a work surface with a slope greater than 10° to the horizontal plane. The 4 feet of the machine must always be supported on this surface.
9. Unplug the appliance before any intervention on it: cleaning, maintenance or servicing.
10. Do not use the appliance with a damaged power cord. It must be replaced by a SANTOS authorized dealer or the SANTOS company, or similarly qualified persons, to avoid danger.
11. Use only original SANTOS-certified spare parts.
12. Switch the switch (11) to "OFF" when the appliance is not in operation.
13. Do not connect multiple appliances to the same power outlet.
14. Do not use the appliance outdoors.
15. Do not place the appliance near, or on, a heat source.
16. This appliance is a professional appliance intended for professional use only. It is not intended for household use.
17. This appliance is not intended to be used by persons (including children less than 8 years old) with reduced physical, sensory or mental capabilities, or lack of experience or knowledge, unless they are overseen by a person

responsible for their safety, monitoring or prior instruction regarding the use of the appliance.

Children should be supervised to ensure that they do not play with the appliance.

18. This appliance is intended for collective use, e.g. in restaurant kitchens, canteens, hospitals and small commercial businesses such as bakeries, butchers, etc., but not for the continuous mass production of food.

ELECTRICAL CONNECTION:

The appliance is available for 2 single-phase voltage supplies:

- 110-120V 50/60Hz: model 76V1
- 220-240V 50/60Hz: model 76

Line protection: the appliance must be connected to a standard 2-pole + earth socket. The installation must be equipped with an RCD and a fuse rated at 16A. **The appliance must be earthed.** (fig. B)

CAUTION:



- Before connecting the appliance, check that the mains voltage matches the voltage of your appliance. Its value is indicated:
 - either on the manufacturer's plate (15) under the appliance.
 - or on the manufacturer's plate on the last page of this manual.
- If the power cable (10) is damaged, it must be replaced by a SANTOS authorized dealer or the SANTOS company, or similarly qualified persons, to avoid danger.

CAUTION!



Check that the switch (11) is in the "OFF" position (fig. A) before you connect the power cord plug (10) to your AC power outlet.

1st USE

Correctly clean the parts in contact with the coffee (fig. A).

- Remove the cover (1), the bean hopper (2), the grounds collector (19) and wash them with a standard household washing up liquid.

END-OF-LIFE PRODUCT RECYCLING

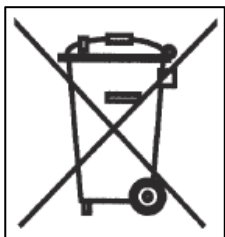

This appliance is marked with the symbol for the selective sorting of waste electrical and electronic equipment. This means that the product must be taken in hand by a selective collection system in accordance with Directive 2012/19/EU (WEEE) – Business appliances part – to be recycled or dismantled in order to reduce environmental impact.

For more information, please contact your dealer or the SANTOS company.

For disposal or recycling of the components of the appliance, please contact a specialised company or the SANTOS company

Electronic products that have not been selectively sorted are potentially hazardous to the environment.

Packaging materials must be disposed of or recycled in accordance with the regulations in force.

YOUR COFFEE GRINDER NO. 76

- The coffee grinder No. 76 is intended for bars, cafés, hotels, restaurants. It adapts to all espresso coffee machines.
- The appliance consists of a grinding unit and a base made of aluminium, a bean hopper made of transparent plastic.
- The appliance allows roasted coffee to be ground and dispensed instantaneously.
- The grind setting can be adjusted (from Filter, Fine, to Espresso),
- The appliance is intended exclusively for professional use.

USING THE APPLIANCE

FIRST USE:

1. **Place the grounds collector (19)** in front of the base **(4)**.
2. **Adjust the height of the portafilter fork (18)** using the screws so that it corresponds to your portafilter
3. **Pour the roasted coffee beans** into the bean hopper **(2)** and place the cover on the bean hopper.
4. Open the shutter of the bean hopper **(3)**.

USE:

1. Place the portafilter or recipient under the coffee outlet **(17)** using the portafilter fork **(18)** or not.
2. Turn the appliance on by turning the switch **(11)** to the **"On" position** or by holding the switch in the **"Pulse" position** (the motor turns on).
 - **"On" position** the appliance delivers a dose continuously.
 - **"Pulse" position** the appliance delivers a customised dose.



CAUTION!

The appliance is not intended for continuous operation Follow the intermittent cycle of 5 seconds on and 90 seconds off

3. The coffee beans are then ground by the burrs and the grind exists from the grinding body to fill the portafilter.
4. Switch off the appliance by setting the switch (11) to "Off"
5. Remove the portafilter and tamp the coffee.

Grind setting:

Note: Never operate the appliance with the two burrs in contact. Putting the burrs in contact can cause the grind to jam in the grinding body and premature wear of the burrs.

The appliance is factory set so that the "0" mark on the graduated plate (12) of the adjustment nut (6) corresponds to the finest grind without the burrs touching each other.

The appliance is delivered with the grind set to the espresso type: **mark 12** on the adjustment nut (6) (fig. C).

1. Hold the adjustment nut (6) with one hand and use your other hand to press on the indexing pin (7)
2. Tighten the adjustment nut clockwise (right-handed thread) one or two notches for finer grinding.
3. Loosen the adjustment nut anticlockwise (right-handed thread) one or two notches for coarser grinding.
4. Release the indexing lever (7) to lock the adjustment nut (6).
5. Deliver a few doses of coffee to check the grind setting.

The appliance can obtain a very fine grind. You must however make sure, according to the type of coffee used, that the burrs do not come into contact. This would cause the flow to drop substantially and would distort the aroma of the coffee.

CLEANING:



IMPORTANT:

- In all cases, turn off the appliance and unplug the appliance power cord (10).
- The appliance must not be cleaned with a water jet, water under pressure or steam cleaner
- Clean the coffee outlet area regularly, but make sure nothing gets into the conduit (17)

SERVICING

Before working on the appliance, it is essential to disconnect it from the mains.

Spare parts:

This machine does not require any particular maintenance. The bearings are lubricated for life.

If it is necessary to replace wear parts such as burrs, electrical components or other parts, refer to the parts list (see exploded view at the end of this manual).

When **ordering spare parts** (for part numbers see the exploded view at the end of this manual), specify:

- the type,
- the serial number of the appliance and
- the electrical specifications (15) marked on the bottom of the appliance.

Prolonged non-use:

This appliance has no restrictions to prolonged inactivity. We simply recommend cleaning it before use and checking the condition of the components of the appliance (e.g. power cord, seals and other spare parts). If the appliance will not be used for more than 1 month, it is recommended to vacuum out any coffee residue in the grinding body in order to prevent the risk of fouling by clumping and hardening.

Replacing burrs:



IMPORTANT: always replace the 2 burrs (9) at the same time.
Use SANTOS burrs:
Refer to the table of the appliance's specifications to order the reference for the burrs set that corresponds to your appliance.

The 2 burrs are identical and can be mounted on the burr support plate (8) (movable burr) or on the adjustment nut (6) (fixed burr) (fig. F).

1. Close the shutter of the bean hopper (3) (fig. G).
2. Turn on the appliance until the coffee beans in the grinding body have passed.
3. Turn off the appliance and disconnect the power cord (10) (fig. B).
4. Unscrew the pressure screw from the bean hopper (20) and remove the bean hopper (2) (fig. G).
5. Unscrew the 2 screws (21) then remove the removable adjustment nut assembly (fig. G).

Caution! When it is completely removed, handle this assembly carefully so as to avoid damaging its geometry and its operation. (fig. J)

6. Unscrew the 3 screws from each burr (fig. F).
To lock the rotation of the burr support plate (8) when unscrewing or screwing the fastening screws of the movable burr, remove the anti-static tab (22), place a non-aggressive screwdriver between the outlet of the grinding body and one of the fins of the plate.
7. Perfectly clean the entire grinding body and in particular the burrs supports.
8. Place each burr on its support, making sure that there is no coffee dust between the burr and its support.



CAUTION! The slightest small coffee particle placed under the burr can interfere with the proper operation of the appliance. We recommend cleaning the grinding body assembly with a compressed air jet or a dry brush.

CAUTION! do not unscrew the burr support plate (8) in order to avoid damaging the geometry of the whole (fig. H).

9. Once the 2 burrs are replaced, put the anti-static tab back in place (22) put the removable adjustment nut assembly (fig. J) back into its housing.
10. Screw the 2 screws (21) on the removable adjustment nut assembly (fig. G)
11. Place the bean hopper (2) on the nut (6) then screw the pressure screw of the hopper (21)

TROUBLESHOOTING ASSISTANCE

It is necessary to identify what has caused the appliance to stop working. In any case, if the problem persists, switch off (unplug the power cord (10)) and call in maintenance service or contact an approved SANTOS dealer. If necessary, remember to close the shutter of the bean hopper (3) before removing the hopper.

The appliance does not start:

- Check that the overcurrent protector (13) has not been triggered after an overload. (see the paragraph "The appliance stops following a motor overload ")
- Check: the mains supply, the condition of the power cord (10).
- Check that the burrs (9) are not in contact and prevent the motor from starting.
- Check that there are no foreign objects caught between the burrs.
- Inside the appliance: check the condition of the electrical wires and the connections,
- Check the electrical components by replacing them one after the other.

The appliance stops because the motor has overheated: (the motor unit is hot)

The motor is protected by a built-in thermal protector. The appliance stops if the motor overheats.

- Check that there are still coffee beans in the bean hopper (2).
- Move the switch (11) to the "OFF" position, unplug the mains plug.
- Wait for the motor to cool down (20 to 45 minutes), then press the button (11). ("On" or "Pulse" position).

The appliance stops following an overload:

Motor overload can be caused by a foreign body between the burrs, the burrs in contact, an excessively fine grind.

In these conditions, either the thermal protector or the overcurrent protector can be activated and stop appliance operation.

If the appliance is hot, then see the "The appliance stops because the motor has overheated" part.

Otherwise:

- Turn off the appliance (unplug the mains plug (10))
- Flip the on/off switch (11) to the "OFF" position.
- Under the appliance (fig. D), push the button (13) to reset the overcurrent protector. If the button does not remain in the "reset" position, allow the appliance to cool before renewing the operation.

If the problem persists, switch off the power (unplug the mains plug (10)) and call in maintenance service or contact a Santos authorised dealer.

The appliance runs without filling the portafilter

- Check that there are coffee beans in the bean hopper.
- Check that the bean hopper shutter (3) is in the open position.
- Try to set a coarser grind
- Replace the burrs (9).

TECHNICAL SPECIFICATIONS OF THE APPLIANCE**TECHNICAL SPECIFICATIONS**

Model 76		76	76V1
Power voltage	(V)	220-240	100-120
Frequency	(Hz)	50/60	50/60
Single-phase Motor: Power			
Absorbed power	(W)	800	700
Speed	(rpm)	3000 at 50Hz / 3600 at 60Hz	
Diameter of the burrs	(mm)	54	54
SANTOS burrs reference		00076	00076
Bean hopper capacity	(kg)	0.4	
Average flow	(kg/h)	18	
Dose setting (approx.)	(g)	From 5.5 to 50	
The appliance is not intended for continuous operation		5 seconds on and 90 seconds off	
Dimensions: Height	(mm)	400	
Width	(mm)	180	
Depth	(mm)	270	
Weight: Net weight	(kg)	7.5	
Shipping weight	(kg)	9.0	
Noise level: (2)	(dBA)	64	

(1) These values are given for information only. The exact electrical characteristics of your appliance are noted on its manufacturer's plate.

(2) Noise level measured at sound pressure with appliance under load at 1 m from its axis according to EN 31201.

Electrical diagram 110-120V 50/60Hz and 220-240V 50/60Hz

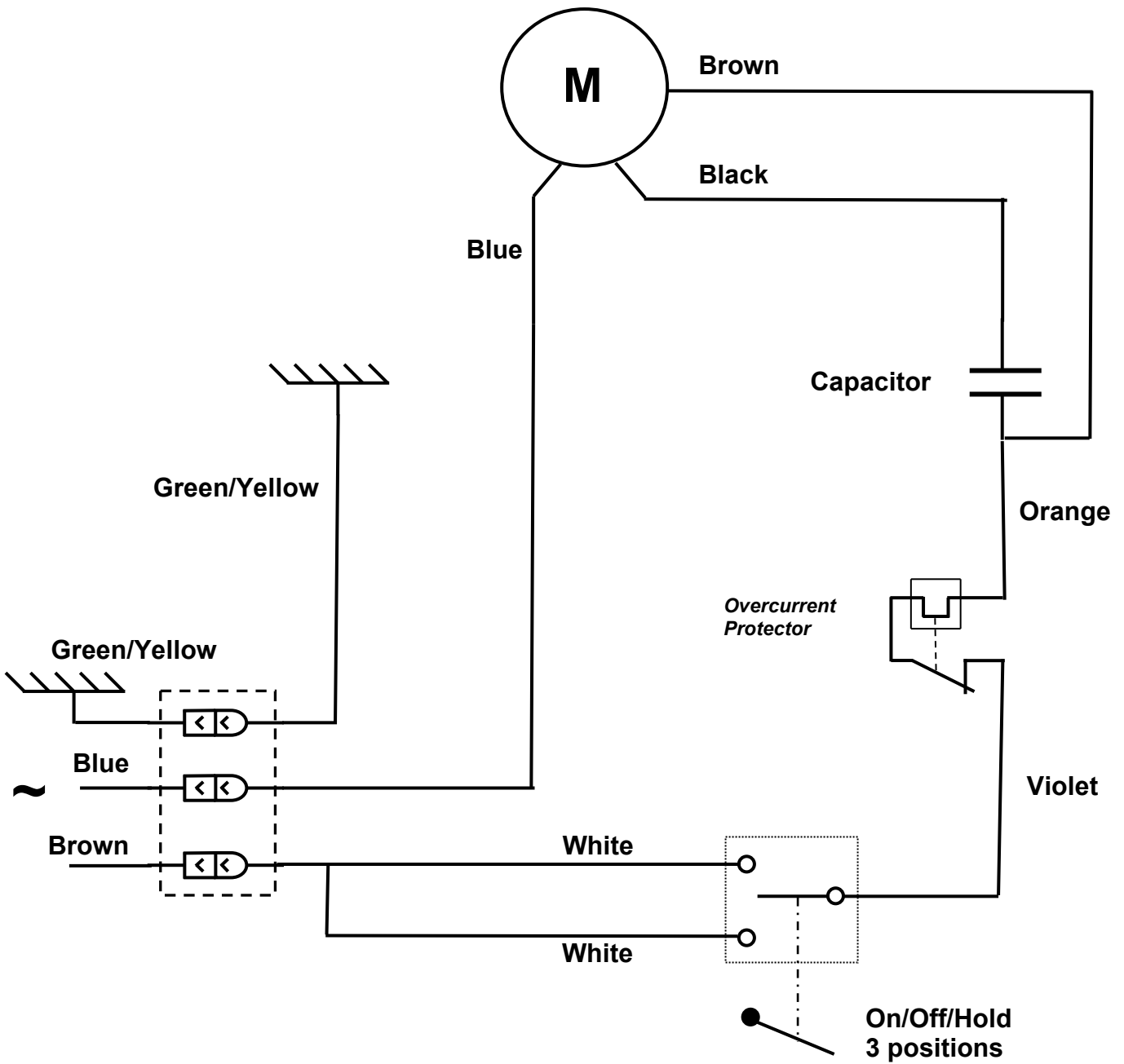

Correlation table

ITEM	Designation
1	Bean hopper cover
2	Bean hopper
3	Bean hopper shutter
4	Base plate
5	Grinding body
6	Adjustment nut
7	Indexing metal plate
8	Burr support plate
9	Burr
10	Power cord plug.
11	On/off/pulse switch
12	Graduated plate
13	Overcurrent protector
14	Capacitor
15	Manufacturer's plate
16	Grinding wheel plate hexagon
17	Ground coffee outlet conduit
18	Portafilter fork
19	Grounds collector
20	Bean hopper pressure screw
21	Removable bolt nut
22	Anti-static tab

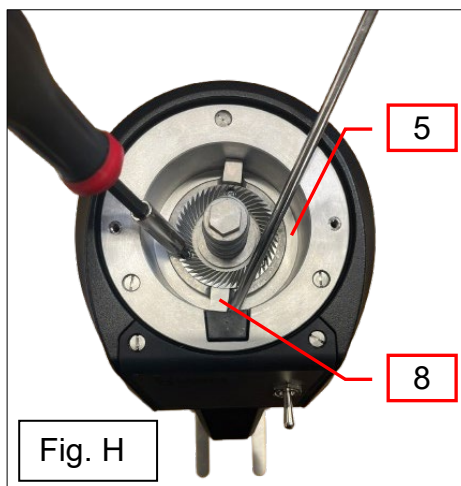
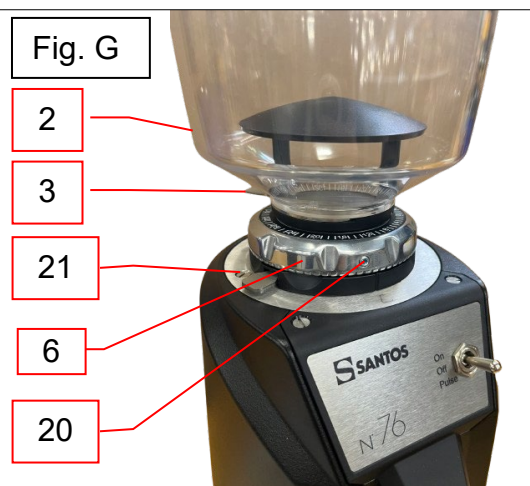
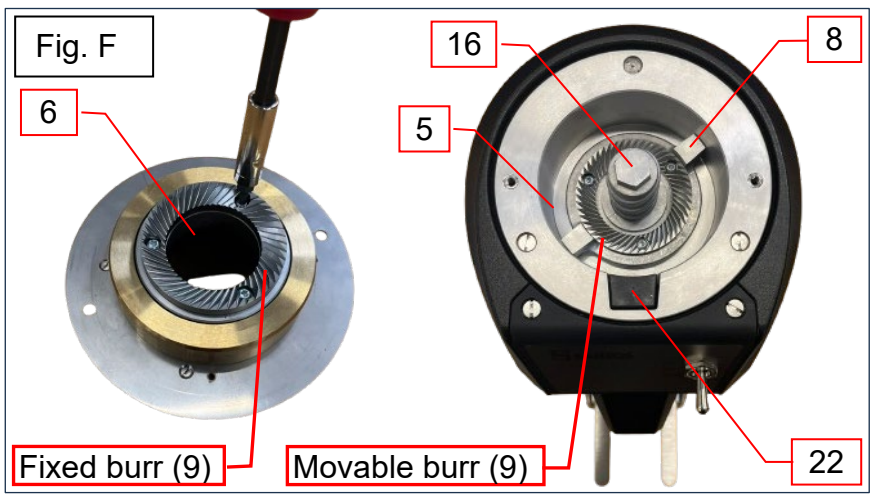
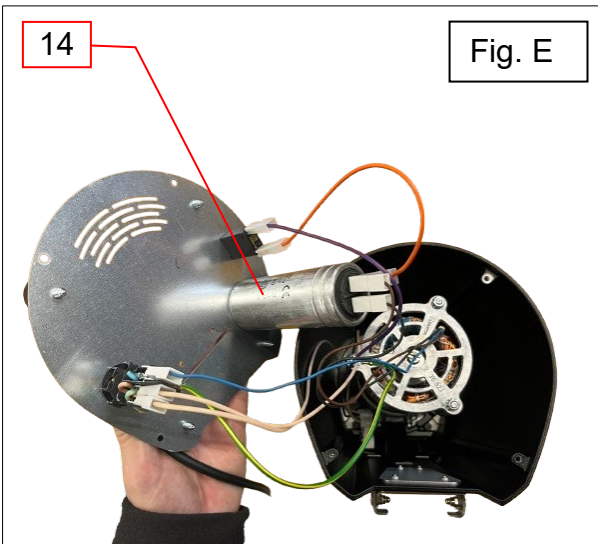
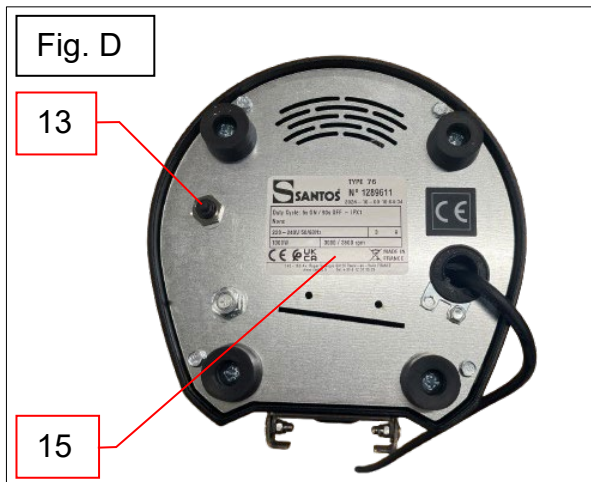
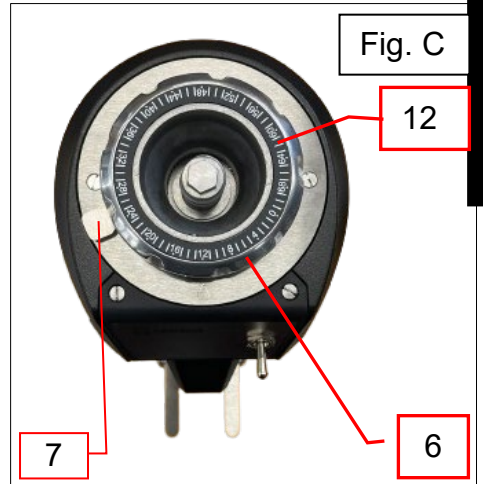
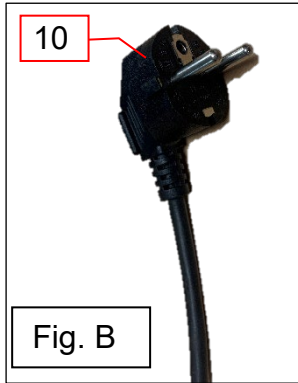

WARRANTY CERTIFICATE

WARRANTY

Since 01.01.95, all our appliances are **CE-compliant** and **CE-marked**. Our warranty is **twenty-four months** from the date of manufacture indicated on the manufacturer's plate, except for asynchronous motors (composed of a rotor and stator) which are warranted for a period of 5 years from the date of manufacture. The warranty is strictly limited to the free replacement of any genuine part recognized by us which is defective as a result of a defect or defect in construction and identified as belonging to the appliance in question. It does not apply to damage resulting from installation or use that does not comply with the instructions accompanying each appliance (user manual) or in the event of an obvious lack of maintenance or failure to observe basic electrical safety rules. The guarantee does not apply in case of natural wear. Any warranty part replacement is performed after the defective part is returned postage prepaid to our workshops, along with a **copy of the Declaration of conformity** which shows the serial number of the unit. Every appliance is fitted with **a CE-compliant manufacturer's plate**, a double of which appears in the Declaration of conformity (serial no., date of manufacture, electrical characteristics, etc.). In the event of a serious damage which is only found to be repairable in our workshops, and **after prior agreement of our services**, any appliance under warranty is shipped postage prepaid by the distributor. In the event of repair or reconditioning of an out-of-warranty appliance, the return transportation is the responsibility of the distributor. Parts and labour are charged at the current rates (spare parts – hourly – labour). A pre-quote may be provided.

Coffee grinders not equipped with original SANTOS grinders are not taken under warranty. The conditions of guarantee, repair, reconditioning, of the espresso coffee grinders are the subject of a specific notice. Our warranty does not extend to the payment of penalties, to the repair of direct or indirect damages, and in particular to any loss of profits resulting from the non-conformity or defect of the products, SANTOS's overall liability being limited to the selling price of the delivered product and the possible repair of defective products.

In the event of a defect being disclosed during the warranty period, the distributor shall, unless otherwise agreed in writing by SANTOS, instruct the customer, to cease all use of the defective product. Such use would release SANTOS from all responsibility.

APPLIANCE MANUFACTURER'S PLATE

EXAMPLE
**For all documents not delivered
with the appliance.**

Printed, faxed or downloaded