

#### MMU-AP0094MH-E Compact 4-way Cassette

- Equipped with draft prevention and clean ceiling functions
- Low noise: low fan speed down to 28dB(A)
- Auxiliary Fresh air intake
- Lift pump up to 850mm lift
- Removable corner "Pockets" for easy installation

Model Reference	MMU-AP0094MH-E
Nominal Cooling (kW)	2.8
Nominal Heating (kW)	3.2
Capacity Code	1.0
Power Input (Cool/Heat) (kW)	0.036
UK Cooling (kW)	2.64
UK Sensible Cooling (kW)	2.02
UK Heating (kW)	2.59
Starting Current (A)	0.52
Running Current (A)	0.30
Suggested Fuse Size (A)	3
Power Supply (V-ph-Hz)	220/240-1-50
Interconnecting Cable	2 Core Screened 1.5mm
Sound Power H-M-L (dB(A))	50-46-41
Sound Pressure H-L (dB(A))	37-28
Air Flow H-L (m <sup>3</sup> /h)	570-378
Air Flow H-L (l/s)	158-105
Dimensions (HxWxD) mm	268 x 575 x 575
Unit Weight (kg)	17
Panel Reference	RBC-UM11 PG (W) -E
Panel Dimensions (HxWxD) mm	27 x 700 x 700

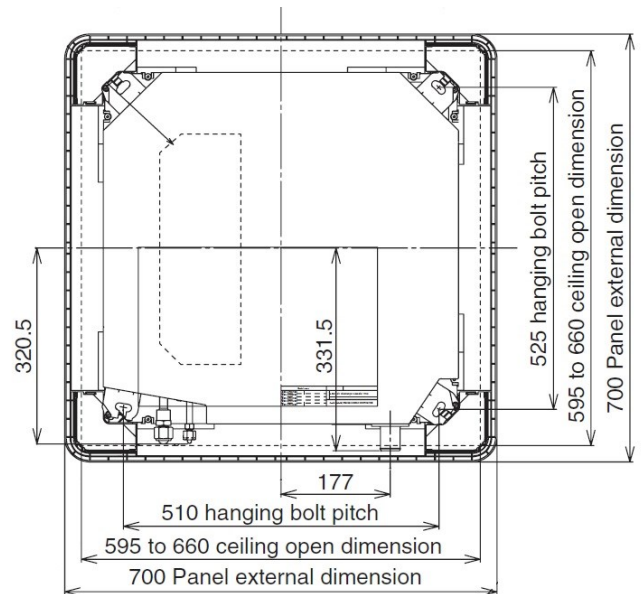
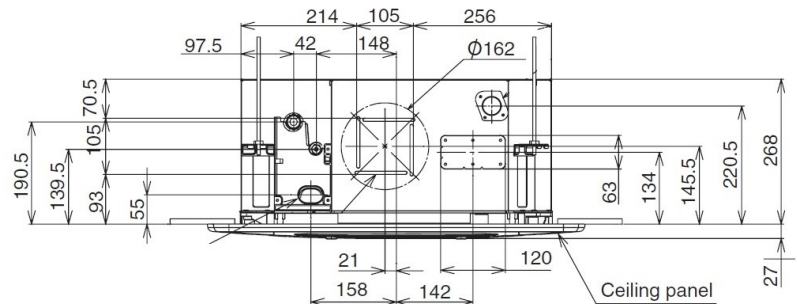

## Cool Designs Ltd

Raising the Standards in Air Conditioning Distribution

[www.cooldesignsltd.co.uk](http://www.cooldesignsltd.co.uk)



All UK duties are based on Cooling Indoor air temperature 22°C DB/16°C WB Outdoor air temperature 28°C DB 50% RH, high fan speed, 5m pipe run.  
Heating Indoor air temperature 21°C DB Outdoor air temperature -4°C DB 100% RH, high fan speed, 5m pipe run. Values are based on the maximum compressor output.  
Data obtained from Toshiba Air Conditioning Web Data July 2013.