

TOSHIBA

FILE NO. A10-034-1

SERVICE MANUAL

AIR-CONDITIONER MULT TYPE

<High Wall Types>

MMK-AP0074MH-E

MMK-AP0094MH-E

MMK-AP0124MH-E

MMK-AP0074MH-TR

MMK-AP0094MH-TR

MMK-AP0124MH-TR

- This Service Manual describes contents of the new High Wall indoor unit.
For the outdoor unit, refer to the Manual with FILE NO. **A10-005, A05-004-1, A05-015.**
- **The service parts will be supplied by TCTC.**



CONTENTS

PRECAUTION FOR SAFETY	6
NEW REFRIGERANT (R410A)	12
1. CONSTRUCTION VIEWS (EXTERNAL VIEWS)	14
2. WIRING DIAGRAM	15
3. PARTS RATING	16
4. REFRIGERANTING CYCLE DIAGRAM	17
5. CONTROL OUTLINE	18
6. CONFIGURATION OF CONTROL CIRCUIT	24
7. APPLIED CONTROL	31
8. TROUBLESHOOTING	44
9. INSTALLATION MANUAL	68
10. HOW TO REPLACE MAIN PARTS	89
11. REPLACEMENT OF SERVICE INDOOR P.C. BOARD	94
12. EXPLODED VIEWS AND PARTS LIST	99

Original instruction

Please read carefully through these instructions that contain important information which complies with the “Machinery” Directive (Directive 2006/42/EC), and ensure that you understand them.

Generic Denomination: Air Conditioner

Definition of Qualified Installer or Qualified Service Person

The air conditioner must be installed, maintained, repaired and removed by a qualified installer or qualified service person.

When any of these jobs is to be done, ask a qualified installer or qualified service person to do them for you.

A qualified installer or qualified service person is an agent who has the qualifications and knowledge described in the table below.

Agent	Qualifications and knowledge which the agent must have
Qualified installer	<ul style="list-style-type: none"> • The qualified installer is a person who installs, maintains, relocates and removes the air conditioners made by Toshiba Carrier Corporation. He or she has been trained to install, maintain, relocate and remove the air conditioners made by Toshiba Carrier Corporation or, alternatively, he or she has been instructed in such operations by an individual or individuals who have been trained and is thus thoroughly acquainted with the knowledge related to these operations. • The qualified installer who is allowed to do the electrical work involved in installation, relocation and removal has the qualifications pertaining to this electrical work as stipulated by the local laws and regulations, and he or she is a person who has been trained in matters relating to electrical work on the air conditioners made by Toshiba Carrier Corporation or, alternatively, he or she has been instructed in such matters by an individual or individuals who have been trained and is thus thoroughly acquainted with the knowledge related to this work. • The qualified installer who is allowed to do the refrigerant handling and piping work involved in installation, relocation and removal has the qualifications pertaining to this refrigerant handling and piping work as stipulated by the local laws and regulations, and he or she is a person who has been trained in matters relating to refrigerant handling and piping work on the air conditioners made by Toshiba Carrier Corporation or, alternatively, he or she has been instructed in such matters by an individual or individuals who have been trained and is thus thoroughly acquainted with the knowledge related to this work. • The qualified installer who is allowed to work at heights has been trained in matters relating to working at heights with the air conditioners made by Toshiba Carrier Corporation or, alternatively, he or she has been instructed in such matters by an individual or individuals who have been trained and is thus thoroughly acquainted with the knowledge related to this work.
Qualified service person	<ul style="list-style-type: none"> • The qualified service person is a person who installs, repairs, maintains, relocates and removes the air conditioners made by Toshiba Carrier Corporation. He or she has been trained to install, repair, maintain, relocate and remove the air conditioners made by Toshiba Carrier Corporation or, alternatively, he or she has been instructed in such operations by an individual or individuals who have been trained and is thus thoroughly acquainted with the knowledge related to these operations. • The qualified service person who is allowed to do the electrical work involved in installation, repair, relocation and removal has the qualifications pertaining to this electrical work as stipulated by the local laws and regulations, and he or she is a person who has been trained in matters relating to electrical work on the air conditioners made by Toshiba Carrier Corporation or, alternatively, he or she has been instructed in such matters by an individual or individuals who have been trained and is thus thoroughly acquainted with the knowledge related to this work. • The qualified service person who is allowed to do the refrigerant handling and piping work involved in installation, repair, relocation and removal has the qualifications pertaining to this refrigerant handling and piping work as stipulated by the local laws and regulations, and he or she is a person who has been trained in matters relating to refrigerant handling and piping work on the air conditioners made by Toshiba Carrier Corporation or, alternatively, he or she has been instructed in such matters by an individual or individuals who have been trained and is thus thoroughly acquainted with the knowledge related to this work. • The qualified service person who is allowed to work at heights has been trained in matters relating to working at heights with the air conditioners made by Toshiba Carrier Corporation or, alternatively, he or she has been instructed in such matters by an individual or individuals who have been trained and is thus thoroughly acquainted with the knowledge related to this work.

Definition of Protective Gear

When the air conditioner is to be transported, installed, maintained, repaired or removed, wear protective gloves and 'safety' work clothing.



In addition to such normal protective gear, wear the protective gear described below when undertaking the special work detailed in the table below.

Failure to wear the proper protective gear is dangerous because you will be more susceptible to injury, burns, electric shocks and other injuries.

Work undertaken	Protective gear worn
All types of work	Protective gloves 'Safety' working clothing
Electrical-related work	Gloves to provide protection for electricians and from heat Insulating shoes Clothing to provide protection from electric shock
Work done at heights (50 cm or more)	Helmets for use in industry
Transportation of heavy objects	Shoes with additional protective toe cap
Repair of outdoor unit	Gloves to provide protection for electricians and from heat



The important contents concerned to the safety are described on the product itself and on this Service Manual. Please read this Service Manual after understanding the described items thoroughly in the following contents (Indications/Illustrated marks), and keep them.

[Explanation of indications]

Indication	Explanation
 DANGER	Indicates contents assumed that an imminent danger causing a death or serious injury of the repair engineers and the third parties when an incorrect work has been executed.
 WARNING	Indicates possibilities assumed that a danger causing a death or serious injury of the repair engineers, the third parties, and the users due to troubles of the product after work when an incorrect work has been executed.
 CAUTION	Indicates contents assumed that an injury or property damage (*) may be caused on the repair engineers, the third parties, and the users due to troubles of the product after work when an incorrect work has been executed.

* Property damage: Enlarged damage concerned to property, furniture, and domestic animal/pet







[Explanation of illustrated marks]

Mark	Explanation
	Indicates prohibited items (Forbidden items to do) The sentences near an illustrated mark describe the concrete prohibited contents.
	Indicates mandatory items (Compulsory items to do) The sentences near an illustrated mark describe the concrete mandatory contents.
	Indicates cautions (Including danger/warning) The sentences or illustration near or in an illustrated mark describe the concrete cautious contents.

Warning Indications on the Air Conditioner Unit

[Confirmation of warning label on the main unit]





Confirm that labels are indicated on the specified positions
 If removing the label during parts replace, stick it as the original.

Warning indication	Description		
 <table border="1" data-bbox="309 461 852 658"> <tr> <td data-bbox="309 461 852 524" style="text-align: center;">WARNING</td> </tr> <tr> <td data-bbox="309 524 852 658"> <p style="text-align: center;">ELECTRICAL SHOCK HAZARD</p> <p>Disconnect all remote electric power supplies before servicing.</p> </td> </tr> </table>	WARNING	<p style="text-align: center;">ELECTRICAL SHOCK HAZARD</p> <p>Disconnect all remote electric power supplies before servicing.</p>	<p>WARNING</p> <p>ELECTRICAL SHOCK HAZARD Disconnect all remote electric power supplies before servicing.</p>
WARNING			
<p style="text-align: center;">ELECTRICAL SHOCK HAZARD</p> <p>Disconnect all remote electric power supplies before servicing.</p>			
 <table border="1" data-bbox="309 736 852 934"> <tr> <td data-bbox="309 736 852 799" style="text-align: center;">WARNING</td> </tr> <tr> <td data-bbox="309 799 852 934"> <p>Moving parts. Do not operate unit with grille removed. Stop the unit before the servicing.</p> </td> </tr> </table>	WARNING	<p>Moving parts. Do not operate unit with grille removed. Stop the unit before the servicing.</p>	<p>WARNING</p> <p>Moving parts. Do not operate unit with grille removed. Stop the unit before the servicing.</p>
WARNING			
<p>Moving parts. Do not operate unit with grille removed. Stop the unit before the servicing.</p>			
 <table border="1" data-bbox="309 1014 852 1211"> <tr> <td data-bbox="309 1014 852 1077" style="text-align: center;">CAUTION</td> </tr> <tr> <td data-bbox="309 1077 852 1211"> <p>High temperature parts. You might get burned when removing this panel.</p> </td> </tr> </table>	CAUTION	<p>High temperature parts. You might get burned when removing this panel.</p>	<p>CAUTION</p> <p>High temperature parts. You might get burned when removing this panel.</p>
CAUTION			
<p>High temperature parts. You might get burned when removing this panel.</p>			
 <table border="1" data-bbox="309 1292 852 1489"> <tr> <td data-bbox="309 1292 852 1355" style="text-align: center;">CAUTION</td> </tr> <tr> <td data-bbox="309 1355 852 1489"> <p>Do not touch the aluminum fins of the unit. Doing so may result in injury.</p> </td> </tr> </table>	CAUTION	<p>Do not touch the aluminum fins of the unit. Doing so may result in injury.</p>	<p>CAUTION</p> <p>Do not touch the aluminum fins of the unit. Doing so may result in injury.</p>
CAUTION			
<p>Do not touch the aluminum fins of the unit. Doing so may result in injury.</p>			
 <table border="1" data-bbox="309 1570 852 1767"> <tr> <td data-bbox="309 1570 852 1632" style="text-align: center;">CAUTION</td> </tr> <tr> <td data-bbox="309 1632 852 1767"> <p style="text-align: center;">BURST HAZARD</p> <p>Open the service valves before the operation, otherwise there might be the burst.</p> </td> </tr> </table>	CAUTION	<p style="text-align: center;">BURST HAZARD</p> <p>Open the service valves before the operation, otherwise there might be the burst.</p>	<p>CAUTION</p> <p>BURST HAZARD Open the service valves before the operation, otherwise there might be the burst.</p>
CAUTION			
<p style="text-align: center;">BURST HAZARD</p> <p>Open the service valves before the operation, otherwise there might be the burst.</p>			
 <table border="1" data-bbox="309 1848 852 2045"> <tr> <td data-bbox="309 1848 852 1910" style="text-align: center;">CAUTION</td> </tr> <tr> <td data-bbox="309 1910 852 2045"> <p>Do not climb onto the fan guard. Doing so may result in injury.</p> </td> </tr> </table>	CAUTION	<p>Do not climb onto the fan guard. Doing so may result in injury.</p>	<p>CAUTION</p> <p>Do not climb onto the fan guard. Doing so may result in injury.</p>
CAUTION			
<p>Do not climb onto the fan guard. Doing so may result in injury.</p>			



Precautions for Safety







The manufacturer shall not assume any liability for the damage caused by not observing the description of this manual.







DANGER

 Turn off breaker.	<p>Before carrying out the installation, maintenance, repair or removal work, be sure to set the circuit breaker for both the indoor and outdoor units to the OFF position. Otherwise, electric shocks may result.</p>
	<p>Before opening the intake grille of the indoor unit or service panel of the outdoor unit, set the circuit breaker to the OFF position. Failure to set the circuit breaker to the OFF position may result in electric shocks through contact with the interior parts. Only a qualified installer (*1) or qualified service person (*1) is allowed to remove the intake grille of the indoor unit or service panel of the outdoor unit and do the work required.</p>
	<p>Before starting to repair the outdoor unit fan or fan guard, be absolutely sure to set the circuit breaker to the OFF position, and place a "Work in progress" sign on the circuit breaker.</p>
	<p>When cleaning the filter or other parts of the indoor unit, set the circuit breaker to OFF without fail, and place a "Work in progress" sign near the circuit breaker before proceeding with the work.</p>
	<p>When you have noticed that some kind of trouble (such as when an error display has appeared, there is a smell of burning, abnormal sounds are heard, the air conditioner fails to cool or heat or water is leaking) has occurred in the air conditioner, do not touch the air conditioner yourself but set the circuit breaker to the OFF position, and contact a qualified service person. Take steps to ensure that the power will not be turned on (by marking "out of service" near the circuit breaker, for instance) until qualified service person arrives.</p> <p>Continuing to use the air conditioner in the trouble status may cause mechanical problems to escalate or result in electric shocks or other failure.</p>
 Electric shock hazard.	<p>When you access inside of the service panel to repair electric parts, wait for about five minutes after turning off the breaker. Do not start repairing immediately. Otherwise you may get electric shock by touching terminals of high-voltage capacitors. Natural discharge of the capacitor takes about five minutes.</p>
 Prohibition	<p>Place a "Work in progress" sign near the circuit breaker while the installation, maintenance, repair or removal work is being carried out. There is a danger of electric shocks if the circuit breaker is set to ON by mistake.</p> <p>Before operating the air conditioner after having completed the work, check that the electrical parts box cover of the indoor unit and service panel of the outdoor unit are closed, and set the circuit breaker to the ON position. You may receive an electric shock if the power is turned on without first conducting these checks.</p>
 Stay on protection.	<p>If, in the course of carrying out repairs, it becomes absolutely necessary to check out the electrical parts with the electrical parts box cover of one or more of the indoor units and the service panel of the outdoor unit removed in order to find out exactly where the trouble lies, wear insulated heat-resistant gloves, insulated boots and insulated work overalls, and take care to avoid touching any live parts. You may receive an electric shock if you fail to heed this warning. Only qualified service person (*1) is allowed to do this kind of work.</p>

 **WARNING**

 General.	<p>Before starting to repair the air conditioner, read carefully through the Service Manual, and repair the air conditioner by following its instructions.</p>
	<p>Only qualified service person (*1) is allowed to repair the air conditioner. Repair of the air conditioner by unqualified person may give rise to a fire, electric shocks, injury, water leaks and/or other problems.</p>
	<p>Do not use any refrigerant different from the one specified for complement or replacement. Other wise, abnormally high pressure may be generated in the refrigeration cycle, which may result in a failure or explosion of the product or an injury to your body.</p>
	<p>Only a qualified installer (*1) or qualified service person (*1) is allowed to carry out the electrical work of the air conditioner. Under no circumstances must this work be done by an unqualified individual since failure to carry out the work properly may result in electric shocks and/or electrical leaks.</p>
	<p>When transporting the air conditioner, wear shoes with protective toe caps, protective gloves and other protective clothing.</p>
	<p>When connecting the electrical wires, repairing the electrical parts or undertaking other electrical jobs, wear gloves to provide protection for electricians and from heat, insulating shoes and clothing to provide protection from electric shocks. Failure to wear this protective gear may result in electric shocks.</p>
	<p>Electrical wiring work shall be conducted according to law and regulation in the community and installation manual. Failure to do so may result in electrocution or short circuit.</p>
	<p>Only a qualified installer (*1) or qualified service person (*1) is allowed to undertake work at heights using a stand of 50 cm or more or to remove the intake grille of the indoor unit to undertake work.</p>
	<p>When working at heights, use a ladder which complies with the ISO 14122 standard, and follow the procedure in the ladder's instructions. Also wear a helmet for use in industry as protective gear to undertake the work.</p>
	<p>When working at heights, put a sign in place so that no-one will approach the work location, before proceeding with the work. Parts and other objects may fall from above, possibly injuring a person below.</p>
	<p>When executing address setting, test run, or troubleshooting through the checking window on the electric parts box, put on insulated gloves to provide protection from electric shock. Otherwise you may receive an electric shock.</p>
	<p>Do not touch the aluminum fin of the outdoor unit. You may injure yourself if you do so. If the fin must be touched for some reason, first put on protective gloves and safety work clothing, and then proceed.</p>
	<p>Do not climb onto or place objects on top of the outdoor unit. You may fall or the objects may fall off of the outdoor unit and result in injury.</p>
	<p>When transporting the air conditioner, wear shoes with additional protective toe caps.</p>
	<p>When transporting the air conditioner, do not take hold of the bands around the packing carton. You may injure yourself if the bands should break.</p>
<p>Be sure that a heavy unit (10kg or heavier) such as a compressor is carried by two persons.</p>	
<p>This air conditioner has passed the pressure test as specified in IEC 60335-2-40 Annex EE.</p>	
 Check earth wires.	<p>Before troubleshooting or repair work, check the earth wire is connected to the earth terminals of the main unit, otherwise an electric shock is caused when a leak occurs. If the earth wire is not correctly connected, contact an electric engineer for rework.</p>
	<p>After completing the repair or relocation work, check that the ground wires are connected properly.</p>
	<p>Be sure to connect earth wire. (Grounding work) Incomplete grounding causes an electric shock. Do not connect ground wires to gas pipes, water pipes, and lightning rods or ground wires for telephone wires.</p>
 Prohibition of modification.	<p>Do not modify the products. Do not also disassemble or modify the parts. It may cause a fire, electric shock or injury.</p>

 Use specified parts.	When any of the electrical parts are to be replaced, ensure that the replacement parts satisfy the specifications given in the Service Manual (or use the parts contained on the parts list in the Service Manual). Use of any parts which do not satisfy the required specifications may give rise to electric shocks, smoking and/ or a fire.
 Do not bring a child close to the equipment.	Refrigerantlf, in the course of carrying out repairs, it becomes absolutely necessary to check out the electrical parts with the electrical parts box cover of one or more of the indoor units and the service panel of the outdoor unit removed in order to find out exactly where the trouble lies, put a sign in place so that no-one will approach the work location before proceeding with the work. Third-party individuals may enter the work site and receive electric shocks if this warning is not heeded.
 Insulating measures	Connect the cut-off lead wires with crimp contact, etc., put the closed end side upward and then apply a watercut method, otherwise a leak or production of fire is caused at the users' side.
 No fire	When performing repairs using a gas burner, replace the refrigerant with nitrogen gas because the oil that coats the pipes may otherwise burn. When repairing the refrigerating cycle, take the following measures. 1) Be attentive to fire around the cycle. When using a gas stove, etc., be sure to put out fire before work; otherwise the oil mixed with refrigerant gas may catch fire. 2) Do not use a welder in the closed room. When using it without ventilation, carbon monoxide poisoning may be caused. 3) Do not bring inflammables close to the refrigerant cycle, otherwise fire of the welder may catch the inflammables.
 Refrigerant	The refrigerant used by this air conditioner is the R410A. Check the used refrigerant name and use tools and materials of the parts which match with it. For the products which use R410A refrigerant, the refrigerant name is indicated at a position on the outdoor unit where is easy to see. To prevent miss-charging, the route of the service port is changed from one of the former R22. For an air conditioner which uses R410A, never use other refrigerant than R410A. For an air conditioner which uses other refrigerant (R22, etc.), never use R410A. If different types of refrigerant are mixed, abnormal high pressure generates in the refrigerating cycle and an injury due to breakage may be caused. When the air conditioner has been installed or relocated, follow the instructions in the Installation Manual and purge the air completely so that no gases other than the refrigerant will be mixed in the refrigerating cycle. Failure to purge the air completely may cause the air conditioner to malfunction. Do not charge refrigerant additionally. If charging refrigerant additionally when refrigerant gas leaks, the refrigerant composition in the refrigerating cycle changes resulted in change of air conditioner characteristics or refrigerant over the specified standard amount is charged and an abnormal high pressure is applied to the inside of the refrigerating cycle resulted in cause of breakage or injury. Therefore if the refrigerant gas leaks, recover the refrigerant in the air conditioner, execute vacuuming, and then newly recharge the specified amount of liquid refrigerant. In this time, never charge the refrigerant over the specified amount. When recharging the refrigerant in the refrigerating cycle, do not mix the refrigerant or air other than R410A into the specified refrigerant. If air or others is mixed with the refrigerant, abnormal high pressure generates in the refrigerating cycle resulted in cause of injury due to breakage. After installation work, check the refrigerant gas does not leak. If the refrigerant gas leaks in the room, poisonous gas generates when gas touches to fire such as fan heater, stove or cooking stove though the refrigerant gas itself is innocuous. Never recover the refrigerant into the outdoor unit. When the equipment is moved or repaired, be sure to recover the refrigerant with recovering device. The refrigerant cannot be recovered in the outdoor unit; otherwise a serious accident such as breakage or injuryis caused.
 Assembly/ Wiring	After repair work, surely assemble the disassembled parts, and connect and lead the removed wires as before. Perform the work so that the cabinet or panel does not catch the inner wires. If incorrect assembly or incorrect wire connection was done, a disaster such as a leak or fire is caused at user's side.
 Insulator check	After the work has finished, be sure to use an insulation tester set (500V Megger) to check the resistance is 1MΩ or more between the charge section and the non-charge metal section (Earth position). If the resistance value is low, a disaster such as a leak or electric shock is caused at user's side.

 Ventilation	<p>When the refrigerant gas leaks during work, execute ventilation. If the refrigerant gas touches to a fire, poisonous gas generates. A case of leakage of the refrigerant and the closed room full with gas is dangerous because a shortage of oxygen occurs. Be sure to execute ventilation.</p>
 Compulsion	<p>When the refrigerant gas leaks, find up the leaked position and repair it surely. If the leaked position cannot be found up and the repair work is interrupted, pump-down and tighten the service valve, otherwise the refrigerant gas may leak into the room. The poisonous gas generates when gas touches to fire such as fan heater, stove or cooking stove though the refrigerant gas itself is innocuous. When installing equipment which includes a large amount of charged refrigerant such as a multi air conditioner in a sub-room, it is necessary that the density does not the limit even if the refrigerant leaks. If the refrigerant leaks and exceeds the limit density, an accident of shortage of oxygen is caused.</p> <p>Tighten the flare nut with a torque wrench in the specified manner. Excessive tighten of the flare nut may cause a crack in the flare nut after a long period, which may result in refrigerant leakage.</p> <p>Nitrogen gas must be used for the airtight test.</p> <p>The charge hose must be connected in such a way that it is not slack.</p> <p>For the installation/moving/reinstallation work, follow to the Installation Manual. If an incorrect installation is done, a trouble of the refrigerating cycle, water leak, electric shock or fire is caused.</p>
 Check after repair	<p>Once the repair work has been completed, check for refrigerant leaks, and check the insulation resistance and water drainage. Then perform a trial run to check that the air conditioner is running properly.</p> <p>After repair work has finished, check there is no trouble. If check is not executed, a fire, electric shock or injury may be caused. For a check, turn off the power breaker.</p> <p>After repair work (installation of front panel and cabinet) has finished, execute a test run to check there is no generation of smoke or abnormal sound. If check is not executed, a fire or an electric shock is caused. Before test run, install the front panel and cabinet.</p> <p>Be sure to fix the screws back which have been removed for installation or other purposes.</p>
 Do not operate the unit with the valve closed.	<p>Check the following matters before a test run after repairing piping.</p> <ul style="list-style-type: none"> • Connect the pipes surely and there is no leak of refrigerant. • The valve is opened. <p>Running the compressor under condition that the valve closes causes an abnormal high pressure resulted in damage of the parts of the compressor and etc. and moreover if there is leak of refrigerant at connecting section of pipes, the air is sucked and causes further abnormal high pressure resulted in burst or injury.</p>
 Check after reinstallation	<p>Only a qualified installer (*1) or qualified service person (*1) is allowed to relocate the air conditioner. It is dangerous for the air conditioner to be relocated by an unqualified individual since a fire, electric shocks, injury, water leakage, noise and/or vibration may result.</p> <p>Check the following items after reinstallation.</p> <ol style="list-style-type: none"> 1) The earth wire is correctly connected. 2) The power cord is not caught in the product. 3) There is no inclination or unsteadiness and the installation is stable. <p>If check is not executed, a fire, an electric shock or an injury is caused.</p> <p>When carrying out the pump-down work shut down the compressor before disconnecting the refrigerant pipe. Disconnecting the refrigerant pipe with the service valve left open and the compressor still operating will cause air, etc. to be sucked in, raising the pressure inside the refrigeration cycle to an abnormally high level, and possibly resulting in reputing, injury, etc.</p>
 Cooling check	<p>When the service panel of the outdoor unit is to be opened in order for the compressor or the area around this part to be repaired immediately after the air conditioner has been shut down, set the circuit breaker to the OFF position, and then wait at least 10 minutes before opening the service panel. If you fail to heed this warning, you will run the risk of burning yourself because the compressor pipes and other parts will be very hot to the touch. In addition, before proceeding with the repair work, wear the kind of insulated heat-resistant gloves designed to protect electricians.</p> <p>Take care not to get burned by compressor pipes or other parts when checking the cooling cycle while running the unit as they get heated while running. Be sure to put on gloves providing protection for electric shock and heat.</p> <p>When the service panel of the outdoor unit is to be opened in order for the fan motor, reactor, inverter or the areas around these parts to be repaired immediately after the air conditioner has been shut down, set the circuit breaker to the OFF position, and then wait at least 10 minutes before opening the service panel. If you fail to heed this warning, you will run the risk of burning yourself because the fan motor, reactor, inverter heat sink and other parts will be very hot to the touch. In addition, before proceeding with the repair work, wear the kind of insulated heat-resistant gloves designed to protect electricians.</p>

 Installation	<p>Only a qualified installer (*1) or qualified service person (*1) is allowed to install the air conditioner. If the air conditioner is installed by an unqualified individual, a fire, electric shocks, injury, water leakage, noise and/or vibration may result.</p>
	<p>Before starting to install the air conditioner, read carefully through the Installation Manual, and follow its instructions to install the air conditioner.</p>
	<p>Be sure to use the company-specified products for the separately purchased parts. Use of non-specified products may result in fire, electric shock, water leakage or other failure. Have the installation performed by a qualified installer.</p>
	<p>Do not supply power from the power terminal block equipped on the outdoor unit to another outdoor unit. Capacity overflow may occur on the terminal block and may result in fire.</p>
	<p>Do not install the air conditioner in a location that may be subject to a risk of exposure to a combustible gas. If a combustible gas leaks and becomes concentrated around the unit, a fire may occur.</p>
	<p>Install the indoor unit at least 2.5 m above the floor level since otherwise the users may injure themselves or receive electric shocks if they poke their fingers or other objects into the indoor unit while the air conditioner is running.</p>
	<p>Install a circuit breaker that meets the specifications in the installation manual and the stipulations in the local regulations and laws.</p>
	<p>Install the circuit breaker where it can be easily accessed by the qualified service person (*1).</p>
	<p>If you install the unit in a small room, take appropriate measures to prevent the refrigerant from exceeding the limit concentration even if it leaks. Consult the dealer from whom you purchased the air conditioner when you implement the measures. Accumulation of highly concentrated refrigerant may cause an oxygen deficiency accident.</p>
<p>Do not place any combustion appliance in a place where it is directly exposed to the wind of air conditioner, otherwise it may cause imperfect combustion.</p>	

Explanations given to user

- If you have discovered that the fan grille is damaged, do not approach the outdoor unit but set the circuit breaker to the OFF position, and contact a qualified service person to have the repairs done.
Do not set the circuit breaker to the ON position until the repairs are completed.

Relocation

- Only a qualified installer (*1) or qualified service person (*1) is allowed to relocate the air conditioner.
It is dangerous for the air conditioner to be relocated by an unqualified individual since a fire, electric shocks, injury, water leakage, noise and/or vibration may result.
- When carrying out the pump-down work shut down the compressor before disconnecting the refrigerant pipe. Disconnecting the refrigerant pipe with the service valve left open and the compressor still operating will cause air, etc. to be sucked in, raising the pressure inside the refrigeration cycle to an abnormally high level, and possibly resulting in reputing, injury, etc.

(*1) Refer to the “Definition of Qualified Installer or Qualified Service Person.”

SPECIFICATIONS

Model	Sound power level (dBA)		Weight (kg) Main unit (Ceiling panel)
	Cooling	Heating	
MMK-AP0074MH-E	*	*	11
MMK-AP0094MH-E	*	*	11
MMK-AP0124MH-E	*	*	11
MMK-AP0074MH-TR	*	*	11
MMK-AP0094MH-TR	*	*	11
MMK-AP0124MH-TR	*	*	11

* Under 70 dBA

DECLARATION OF CONFORMITY

Manufacturer: Toshiba Carrier (Thailand) Co., Ltd.
144/9 Moo5, Bangkadi Industrial Park, Tivanon Road, Tambol Bangkadi,
Amphur Muang, Pathumthani 12000 Thailand

Authorized Representative/
TCF holder: Nick Ball
Toshiba EMEA Engineering Director
Toshiba Carrier UK Ltd.
Porsham Close, Belliver Industrial Estate,
PLYMOUTH, Devon, PL6 7DB.
United Kingdom

Hereby declares that the machinery described below:

Generic Denomination: Air Conditioner

Model/type: Indoor unit
MMK-AP0074MH-E, MMK-AP0094MH-E, MMK-AP0124MH-E
MMK-AP0074MH-TR, MMK-AP0094MH-TR, MMK-AP0124MH-TR

Commercial name: Super Modular Multi System Air Conditioner
Super Heat Recovery Multi System Air Conditioner
MiNi-Super Modular Multi System Air Conditioner (MiNi-SMMS)

Complies with the provisions of the "Machinery" Directive (Directive 2006/42/EC) and the regulations transposing into national law

Complies with the provisions of the following harmonized standard:
EN 378-2: 2008+A1:2009

NOTE

This declaration becomes invalid if technical or operational modifications are introduced without the manufacturer's consent.

• New Refrigerant (R410A)

This air conditioner adopts a new HFC type refrigerant (R410A) which does not deplete the ozone layer.

1. Safety Caution Concerned to New Refrigerant

The pressure of R410A is high 1.6 times of that of the former refrigerant (R22). Accompanied with change of refrigerant, the refrigerating oil has been also changed. Therefore, be sure that water, dust, the former refrigerant or the former refrigerating oil is not mixed into the refrigerating cycle of the air conditioner with new refrigerant during installation work or service work. If an incorrect work or incorrect service is performed, there is a possibility to cause a serious accident. Use the tools and materials exclusive to R410A to purpose a safe work.

2. Cautions on Installation/Service

- (1) Do not mix the other refrigerant or refrigerating oil.

For the tools exclusive to R410A, shapes of all the joints including the service port differ from those of the former refrigerant in order to prevent mixture of them.

- (2) As the use pressure of the new refrigerant is high, use material thickness of the pipe and tools which are specified for R410A.
- (3) In the installation time, use clean pipe materials and work with great attention so that water and others do not mix in because pipes are affected by impurities such as water, oxide scales, oil, etc. Use the clean pipes.
Be sure to brazing with flowing nitrogen gas. (Never use gas other than nitrogen gas.)
- (4) For the earth protection, use a vacuum pump for air purge.
- (5) R410A refrigerant is azeotropic mixture type refrigerant. Therefore use liquid type to charge the refrigerant. (If using gas for charging, composition of the refrigerant changes and then characteristics of the air conditioner change.)

3. Pipe Materials

For the refrigerant pipes, copper pipe and joints are mainly used. It is necessary to select the most appropriate pipes to conform to the standard. Use clean material in which impurities adhere inside of pipe or joint to a minimum.

- (1) Copper pipe

<Piping>

The pipe thickness, flare finishing size, flare nut and others differ according to a refrigerant type.

When using a long copper pipe for R410A, it is recommended to select "Copper or copper-base pipe without seam" and one with bonded oil amount 40mg/10m or less. Also do not use crushed, deformed, discolored (especially inside) pipes. (Impurities cause clogging of expansion valves and capillary tubes.)

<Flare nut>

Use the flare nuts which are attached to the air conditioner unit.

- (2) Joint

The flare joint and socket joint are used for joints of the copper pipe.

The joints are rarely used for installation of the air conditioner. However clear impurities when using them.

4. Tools

(1) Required Tools for R410A

Mixing of different types of oil may cause a trouble such as generation of sludge, clogging of capillary, etc. Accordingly, the tools to be used are classified into the following three types.

- 1) Tools exclusive for R410A (Those which cannot be used for conventional refrigerant (R22))
- 2) Tools exclusive for R410A, but can be also used for conventional refrigerant (R22)
- 3) Tools commonly used for R410A and for conventional refrigerant (R22)

The table below shows the tools exclusive for R410A and their interchangeability.

Tools exclusive for R410A (The following tools for R410A are required.)

Tools whose specifications are changed for R410A and their interchangeability

No.	Used tool	Usage	R410A air conditioner installation		Conventional air conditioner installation
			Existence of new equipment for R410A	Whether conven- tional equipment can be used	Whether new equipment can be used with conventional refrigerant
①	Flare tool	Pipe flaring	Yes	*(Note 1)	Yes
②	Copper pipe gauge for adjusting projection margin	Flaring by conventional flare tool	Yes	*(Note 1)	*(Note 1)
③	Torque wrench	Connection of flare nut	Yes	No	No
④	Gauge manifold	Evacuating, refrigerant charge, run check, etc.	Yesa	No	No
⑤	Charge hose				
⑥	Vacuum pump adapter	Vacuum evacuating	Yes	No	Yes
⑦	Electronic balance for refrigerant charging	Refrigerant charge	Yes	Yes	Yes
⑧	Refrigerant cylinder	Refrigerant charge	Yes	No	No
⑨	Leakage detector	Gas leakage check	Yes	No	Yes
⑩	Charging cylinder	Refrigerant charge	(Note 2)	No	No

(Note 1) When flaring is carried out for R410A using the conventional flare tools, adjustment of projection margin is necessary. For this adjustment, a copper pipe gauge, etc. are necessary.

(Note 2) Charging cylinder for R410A is being currently developed.

General tools (Conventional tools can be used.)

In addition to the above exclusive tools, the following equipments which serve also for R22 are necessary as the general tools.

- | | |
|---|---|
| (1) Vacuum pump
Use vacuum pump by
attaching vacuum pump adapter. | (7) Screwdriver (+, -) |
| (2) Torque wrench | (8) Spanner or Monkey wrench |
| (3) Pipe cutter | (9) Hole core drill |
| (4) Reamer | (10) Hexagon wrench (Opposite side 4mm) |
| (5) Pipe bender | (11) Tape measure |
| (6) Level vial | (12) Metal saw |

Also prepare the following equipments for other installation method and run check.

- | | |
|-----------------|----------------------------------|
| (1) Clamp meter | (3) Insulation resistance tester |
| (2) Thermometer | (4) Electroscope |

1. CONSTRUCTION VIEWS (EXTERNAL VIEWS)

Model: MMK-AP0074MH*, AP0094MH*, AP0124MH*

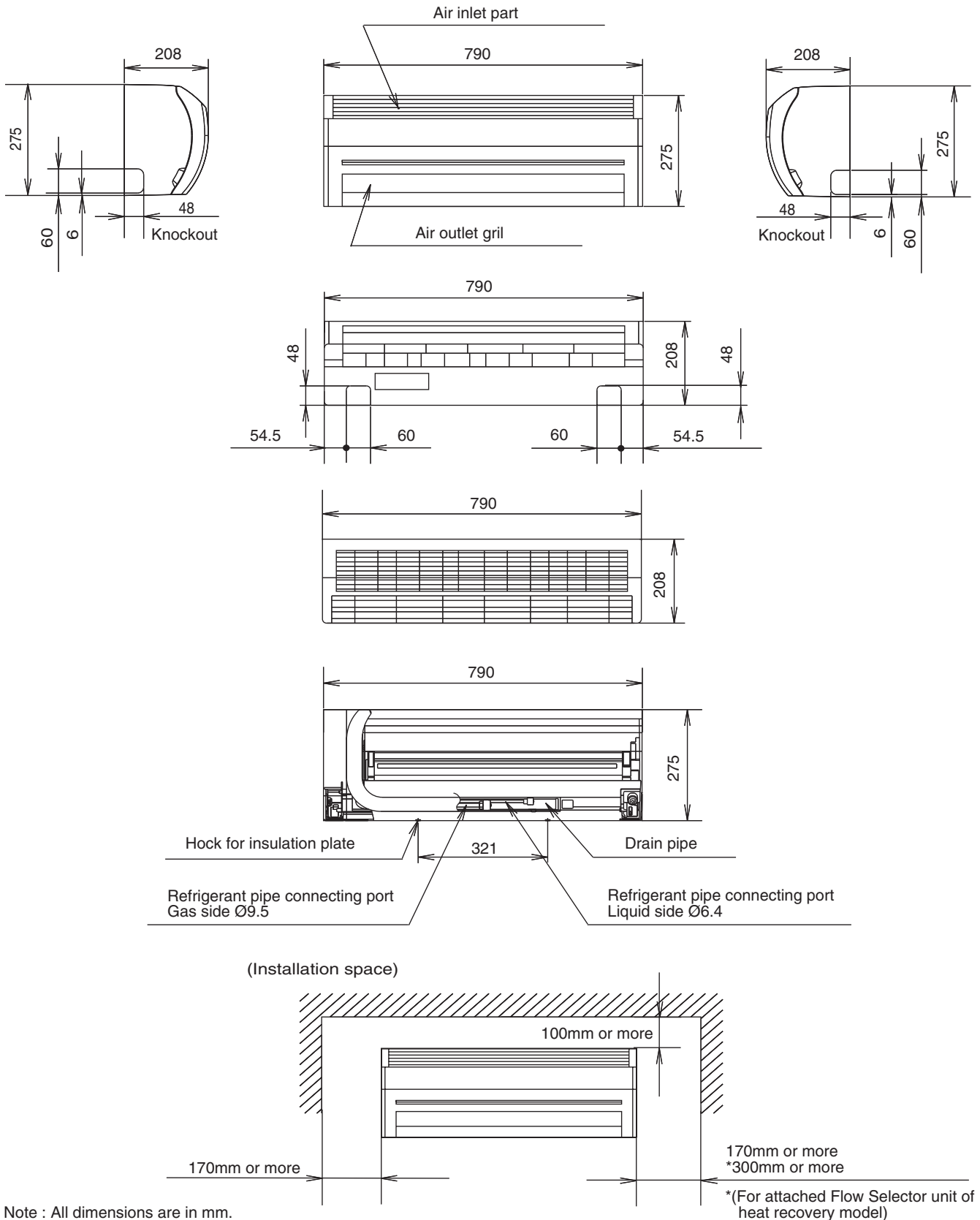

Note : All dimensions are in mm.

3. PARTS RATING

3-1. Parts Rating

No.	Parts Name	Type	Specifications
1	Fan motor (for indoor)	ICF-340-30 MF-340-30	Output (Rated) 30W, 280-340V DC
2	Grille motor	MP24Z	
3	Thermo. Sensor (TA sensor)	318mm	10kΩ at 25°C
4	Heat exchanger sensor (TC1 sensor)	Ø4, 600mm	10kΩ at 25°C
5	Heat exchanger sensor (TC2 sensor)	Ø6, 800mm	10kΩ at 25°C
6	Heat exchanger sensor (TCJ sensor)	Ø6, 800mm	10kΩ at 25°C

3-2. Name of Each Part

Air inlet grille

Air in the room is sucked from here.

Earth screw

Earth screws are provided in the electric parts box.

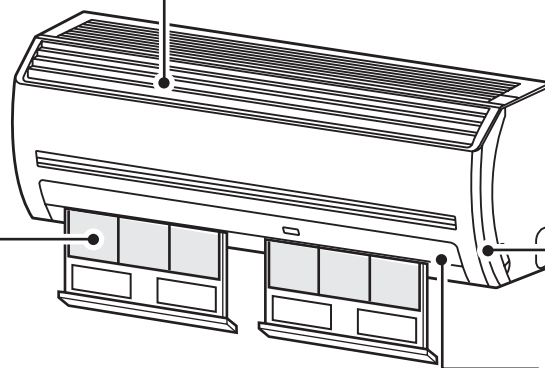

Air filter

Removes dust and trash.
(Air filter is provided in the air inlet grille.)

Air outlet/Air outlet flap

Change the direction of the air to be discharged according to cool/heat mode.

4. REFRIGERATING CYCLE DIAGRAM

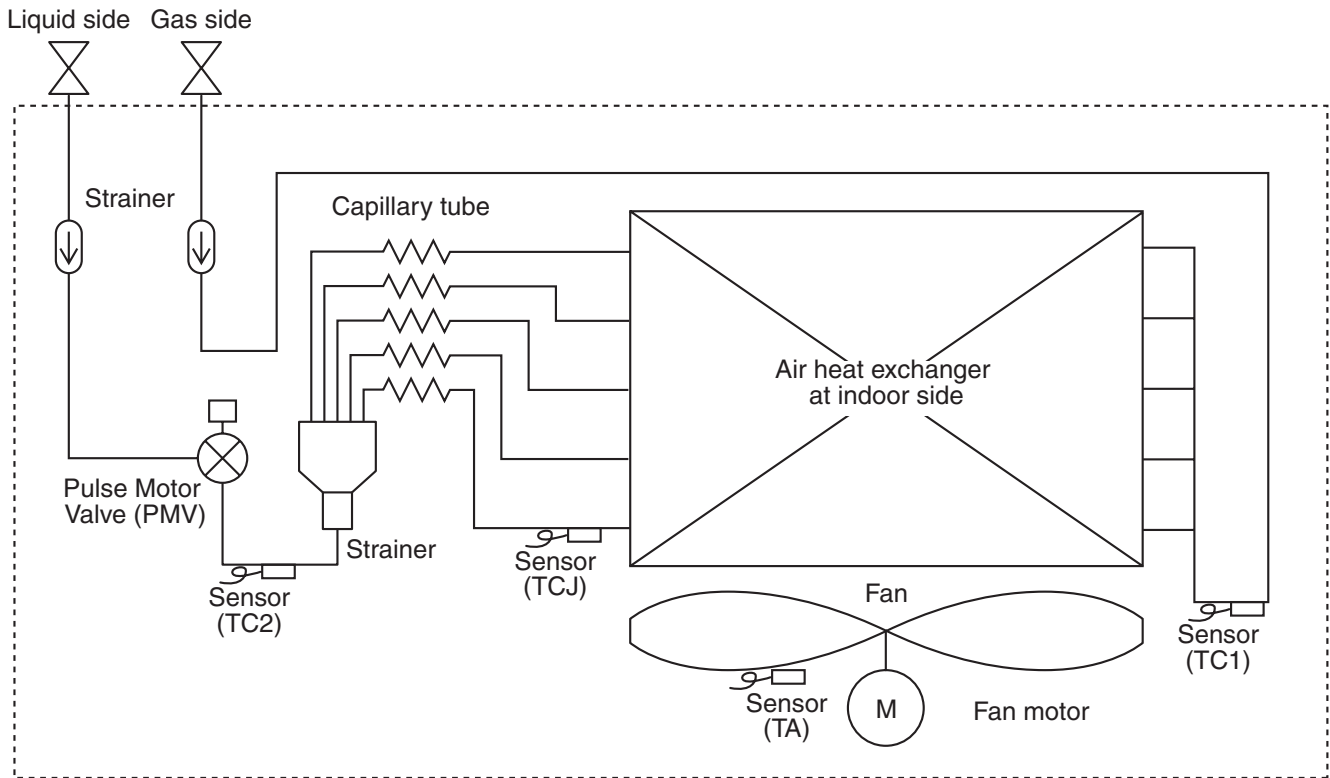







Functional part name		Functional outline
Pulse Motor Valve	PMV	(Connector CN082 (6P): Blue) 1) Controls super heat in cooling operation 2) Controls under cool in heating operation 3) Recovers refrigerant oil in cooling operation 4) Recovers refrigerant oil in heating operation
Temp. sensor	1. TA	(Connector CN104 (2P): White) 1) Detects indoor suction temperature
	2. TC1	(Connector CN100 (3P): Brown) 1) Controls PMV super heat in cooling operation
	3. TC2	(Connector CN101 (2P): Blue) 1) Controls PMV under cool in heating operation
	4. TCJ	(Connector CN102 (2P): Yellow) 1) Controls PMV super heat in cooling operation

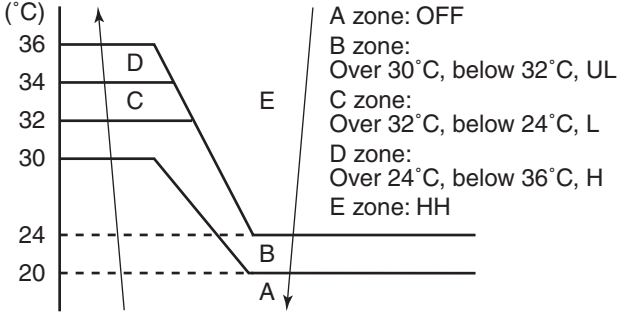

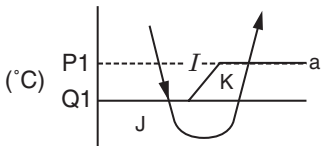
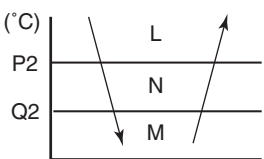
5. CONTROL OUTLINE

5-1. Indoor Unit Control Specifications

No.	Item	Outline of specifications	Remarks																					
1	Power supply is reset.	<p>(1) Distinction of outdoor unit When the power supply is reset, the outdoor units are distinguished, and control is exchanged according to the distinctive results.</p> <p>(2) Check code clear When the power supply is reset, the check code is also reset once. If an abnormal status which the check code appears after Start/Stop button of the remote controller has been pushed continues, the check code is displayed again on the remote controller.</p>	<ul style="list-style-type: none"> Judgment of outdoor unit Exchange of cooling-only unit Exchange of standard model with the flex model 																					
2	Operation select	<p>(1) Based upon the operation select command from the remote controller or central controller, the operation mode is selected.</p> <table border="1"> <thead> <tr> <th>Remote controller command</th> <th>Control outline</th> </tr> </thead> <tbody> <tr> <td>STOP</td> <td>Stops air conditioner.</td> </tr> <tr> <td>FAN</td> <td>Fan operation</td> </tr> <tr> <td>COOL</td> <td>Cooling operation</td> </tr> <tr> <td>DRY</td> <td>Dry operation</td> </tr> <tr> <td>HEAT</td> <td>Heating operation</td> </tr> <tr> <td>AUTO</td> <td>Cooling or HEAT operation mode is automatically selected by Ta and Ts and the unit starts operation.</td> </tr> </tbody> </table> <p>(2) Operation command permission mode Neither AUTO mode of the standard model nor HEAT mode of Cooling-only model can be selected. When a wireless remote control is used, the mode is notified by the receiving sound Pi, Pi (Twice) and alternative flashing of “☺” and “☹”. To release the alternative flashing, change the mode on the wireless remote controller.</p>	Remote controller command	Control outline	STOP	Stops air conditioner.	FAN	Fan operation	COOL	Cooling operation	DRY	Dry operation	HEAT	Heating operation	AUTO	Cooling or HEAT operation mode is automatically selected by Ta and Ts and the unit starts operation.								
Remote controller command	Control outline																							
STOP	Stops air conditioner.																							
FAN	Fan operation																							
COOL	Cooling operation																							
DRY	Dry operation																							
HEAT	Heating operation																							
AUTO	Cooling or HEAT operation mode is automatically selected by Ta and Ts and the unit starts operation.																							
3	Room temp. control	<p>(1) Adjustment range Set temperature on remote controller (°C)</p> <table border="1"> <thead> <tr> <th></th> <th>In cooling/drying</th> <th>In heating</th> </tr> </thead> <tbody> <tr> <td>Wired type</td> <td>18 to 29°C</td> <td>18 to 29°C</td> </tr> <tr> <td>Wireless type</td> <td>17 to 30°C</td> <td>17 to 30°C</td> </tr> </tbody> </table> <p>(2) From the item code 06, the setup temperature in heating operation can be corrected.</p> <table border="1"> <thead> <tr> <th>Setup data</th> <th>0</th> <th>2</th> <th>4</th> <th>6</th> </tr> </thead> <tbody> <tr> <td>Setup temp. correction</td> <td>+0°C</td> <td>+2°C</td> <td>+4°C</td> <td>+6°C</td> </tr> </tbody> </table> <p>Setup at shipment</p> <table border="1"> <tbody> <tr> <td>Setup data</td> <td>2</td> </tr> </tbody> </table>		In cooling/drying	In heating	Wired type	18 to 29°C	18 to 29°C	Wireless type	17 to 30°C	17 to 30°C	Setup data	0	2	4	6	Setup temp. correction	+0°C	+2°C	+4°C	+6°C	Setup data	2	Heating suction temperature shift
	In cooling/drying	In heating																						
Wired type	18 to 29°C	18 to 29°C																						
Wireless type	17 to 30°C	17 to 30°C																						
Setup data	0	2	4	6																				
Setup temp. correction	+0°C	+2°C	+4°C	+6°C																				
Setup data	2																							
4	Automatic capacity control	(1) Based upon difference between Ta and Ts, the operation frequency of the outdoor unit varies.	Ta: Room temperature Ts: Setup temperature																					
5	Air volume control	<p>(1) By the command from the remote controller, “HIGH (HH)”, “MED (H)”, or “LOW (L)” “AUTO” operation is executed. For the wireless remote controller type, “HH”, “H+”, “H”, “L+”, “L”, or “AUTO” operation is executed.</p> <p>(2) While air speed is in AUTO mode, the air speed is changed according to the difference between Ta and Ts.</p>	HH > H+ > H > L+ > L > LL																					



No.	Item	Outline of specifications	Remarks															
6	Prevention of cold air discharge	<p>(1) In heating operation, the upper limit of the fan tap is set by one with higher temperature of TC2 sensor and TCJ sensor.</p> <ul style="list-style-type: none"> • When B zone has continued for 6 minutes, the operation shifts to C zone. • In defrost time, the control point is set to +6°C. 	<ul style="list-style-type: none"> • In D and E zones, priority is given to remote controller air speed setup. • In A and B zones, “” is displayed. 															
7	Freeze prevention control (Low temp. release)	<p>(1) In cooling operation, the air conditioner operates as described below based upon temp. detected by TC1, TC2 and TCJ sensors.</p> <p>To prevent the heat exchanger from freezing, the operation stops.</p> <ul style="list-style-type: none"> • When “J” zone is detected for 5 minutes, the forced thermo is OFF. • In “K” zone, the timer count is interrupted, and held. • When “I” zone is detected, the timer is cleared and the operation returns to the normal operation. • When the forced thermo-OFF became S0 with continuation of “J” zone, operation of the the indoor fan in LOW (L) mode until it reaches the “I” zone. <p>It is reset when the following conditions are satisfied.</p> <p>Reset conditions</p> <ol style="list-style-type: none"> 1) $TC1 \geq 12^{\circ}\text{C}$ and $TC2 \geq 12^{\circ}\text{C}$ and $TCJ \geq 12^{\circ}\text{C}$ 2) 20 minutes passed after stop.  <table border="1" data-bbox="774 1299 1093 1433"> <thead> <tr> <th></th> <th>TC1</th> <th>TC2, TCJ</th> </tr> </thead> <tbody> <tr> <td>P1</td> <td>10°C (5°C)</td> <td>10°C</td> </tr> <tr> <td>Q1</td> <td>0°C</td> <td>-14°C</td> </tr> </tbody> </table> <p>(2) In cooling operation, the air conditioner operates as described below based upon temp. detected by TC2 and TCJ sensors.</p> <ul style="list-style-type: none"> • When “M” zone is detected for 45 minutes, the forced thermo is OFF. • In “N” zone, the timer count is interrupted and held. • When shifting to “M” zone again, the timer count restarts and continues. • If “L” zone is detected, the timer is cleared and the operation returns to normal operation. <p>Reset conditions</p> <ol style="list-style-type: none"> 1) $TC1 \geq 12^{\circ}\text{C}$ and $TC2 \geq 12^{\circ}\text{C}$ and $TCJ \geq 12^{\circ}\text{C}$ 2) 20 minutes passed after stop.  <table border="1" data-bbox="861 1915 1093 2049"> <thead> <tr> <th></th> <th>TC2, TCJ</th> </tr> </thead> <tbody> <tr> <td>P2</td> <td>5°C</td> </tr> <tr> <td>Q2</td> <td>-2.0°C</td> </tr> </tbody> </table>		TC1	TC2, TCJ	P1	10°C (5°C)	10°C	Q1	0°C	-14°C		TC2, TCJ	P2	5°C	Q2	-2.0°C	
	TC1	TC2, TCJ																
P1	10°C (5°C)	10°C																
Q1	0°C	-14°C																
	TC2, TCJ																	
P2	5°C																	
Q2	-2.0°C																	

No.	Item	Outline of specifications	Remarks
8	Cooling oil (refrigerant) recovery control	<p>While the outdoor unit is recovering cooling oil (refrigerant), the indoor units perform the following control tasks: [common for operational (cooling thermo ON/thermo OFF/FAN), as well as nonoperational indoor units]</p> <p>(1) Open the indoor PMV to a certain degree. (2) Engage in recovery control for a specified period of time and return to normal cooling operation at the end of this period upon terminating the control.</p>	<ul style="list-style-type: none"> • Recovery operation normally takes place roughly every 2 hours. • The opening position of the indoor PMV depending on the type and capacity of the indoor unit.
9	Heating refrigerant (oil) recovery control	<p>While the outdoor unit is recovering heating refrigerant (oil), the indoor units perform the following control tasks:</p> <p>(1) Open the indoor PMV to a certain degree. (2) Control the indoor fan according to the operation mode. [Indoor units operating in heating thermo ON/OFF state] Let the indoor fan continue operating, but turn it off if the temperature of the indoor heat exchanger drops. [Indoor units operating in FAN mode] Turn off the indoor fan and display “HEATING STANDBY  ” on the remote controller. [Non-operational indoor units] Keep the indoor fan turned off. (3) Terminate the recovery operation depending on the TC2 temperature reading. The timing of termination is determined by each indoor unit.</p>	<ul style="list-style-type: none"> • Recovery operation normally takes place roughly every hour. • The opening position of the indoor PMV depending on the type and capacity of the indoor unit.
10	Short intermittent operation compensation control	<p>(1) For 5 minutes after the operation has started, the operation is continued even if entering thermostat-OFF condition. (2) However, Cooling/Heating exchange and the system protective control precede and thermostat is OFF.</p>	
11	Elimination of remaining heat	<p>(1) When the air conditioner stops in the “HEAT” mode, drive the indoor fan with “LOW” mode for approx. 30 seconds.</p>	
12	Flap control	<p>(1) Flap position setup (Wired type)</p> <ul style="list-style-type: none"> • The flap position can be set up in the following operation range. <p style="text-align: center;">In cooling/dry operation In heating/fan operation</p> <div style="display: flex; justify-content: space-around; align-items: center;">   </div> <ul style="list-style-type: none"> • In group operation, the flap positions can be set up collectively or individually. <p>(2) Swing setup</p> <ul style="list-style-type: none"> • The swinging position can be moved in the following operation range. <p style="text-align: center;">All modes</p>  <ul style="list-style-type: none"> • In group operation, the swinging positions can be set up collectively or individually. <p>(3) Fix set up (Wireless type) Keep pressing or pressing briefly the FIX button to move the flap in the desired direction. Operating angle of flap will be different during cooling, dry and heating operation.</p> <p>(4) When the unit stops, the flap automatically closes. (5) While the heating operation is ready, the flap automatically moves upward.</p>	

No.	Item	Outline of specifications	Remarks
13	Filter sign display (None in wireless type) * Provided in the separately laid type TCB-AX21E2.	(1) The operation time of the indoor fan is integrated and stored in memory, and the filter exchange signal is sent to the remote controller to display on the remote controller LCD after the specified time. (150H) (2) When the filter reset signal is received from the remote controller, time of the integrated timer is cleared. In this time, if the specified time has passed, the measured time is reset and LCD display disappears.	
14	Operation standby Heating standby	<p><Operation standby> .. Displayed on wired remote controller</p> (1) When any of the DN codes listed below is displayed <ul style="list-style-type: none"> • “P05” - Detection of an open phase in the power supply wiring • “P10” - Detection of indoor flooding in at least one indoor unit • “L30” - Detection of an interlock alarm in at least one indoor unit (2) Forced thermo OFF <ul style="list-style-type: none"> • “COOL/DRY” operation is unavailable because at least one indoor unit is operating in “HEAT” mode. • “HEAT” operation is unavailable because at least one indoor unit is operating in “COOL/DRY” mode under priority cooling setting (bit 1 of SW11 on outdoor I/F P.C. board ON). (3) All indoor units not able to engage in any of the above operations stand by in thermo OFF state. (4) The indoor fan has been turned off because the system is engaged in a heat refrigerant (oil) recovery operation. <p><Heating standby> Displayed on wired remote controller</p> (1) Normal thermo OFF <ul style="list-style-type: none"> • During heating, the indoor unit goes thermo OFF as the heating temperature setting is reached. (2) During heating, the fan rotates at a breeze speed (UL or lower) or remains stationary to prevent cold air from being discharged (including defrosting operation). (3) Forced thermo OFF <ul style="list-style-type: none"> • “HEAT” operation is unavailable because at least one indoor unit is operating in “COOL/DRY” mode under priority cooling setting (bit 1 of SW11 on outdoor I/F P.C. board ON). 	<ul style="list-style-type: none"> • “OPERATION STANDBY  ” displayed No display provided on wireless remote controller • “HEATING STANDBY  ” displayed
15	Selection of central control mode	(1) The range of operations that can be performed via an indoor unit remote controller can be determined through the setting of the central controller. (2) Setting details TCC-Link central control	<ul style="list-style-type: none"> • In the case of a wired remote controller, “CENTRAL CONTROL IN PROGRESS  ” is displayed (lit up) while in central control mode. • The display blinks when a control function inaccessible to a remote controller is chosen. • A wireless remote controller has the same set of control functions, although there is no display. When a control operation is performed via a wireless remote controller while in central control mode, a peep sound alert (5 times) is provided.

Operation via TCC-Link central control	Operation via RBC-AMT32E						RBC-AMT32E display
	Start/stop selection	Operation mode selection	Timer setting	Temperature setting	Fan speed setting	Air flow direction setting	
Individual	○	○	○	○	○	○	“CENTRAL CONTROL IN PROGRESS”
Central 1	×	○	×	○	○	○	
Central 2	×	×	×	×	○	○	
Central 3	○	×	○	×	○	○	
Central 4	○	×	○	○	○	○	

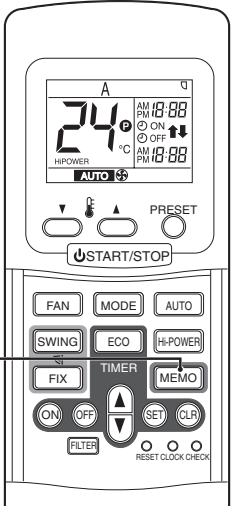
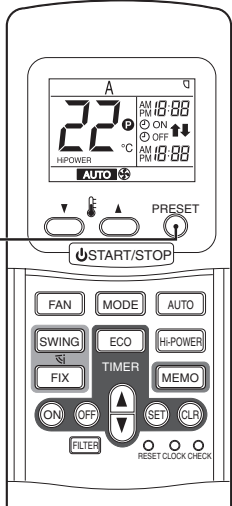
No.	Item	Outline of specifications	Remarks
16	Hi POWER operation (Wireless remote control specific operations)	<p>When you press the Hi POWER button during cooling, heating or A operation, the air conditioner will start the following operation.</p> <ul style="list-style-type: none"> • Cooling operation Performs the cooling operation at 1°C lower than the setting temperature. Only when the fan speed before the Hi POWER operation is not high, the fan speed will be increased. • Heating operation Performs the heating operation at 2°C higher than the setting temperature. Only when the fan speed before the Hi POWER operation is not high, the fan speed will be increased. 	
17	ECO timer operation (Wireless remote control specific operations)	<p>When you press the ECO button during cooling, heating or A operation, the air conditioner will start the following operation. The fan speed display will indicate AUTO and low speed will be used.</p> <ul style="list-style-type: none"> • Cooling operation In the operation suppression zone, where capacity is kept to the minimum, overcooling is prevented by raising the temperature setting by 1°C after 1 hour and by 2°C after 2 hours of operation. The room temperature is thus regulated between the operation suppression zone and the set temperature. • Heating operation In the operation suppression zone, where capacity is kept to the minimum, overheating is prevented by lowering the temperature setting by 1°C after 1 hour and by 2°C after 2 hours of operation. The room temperature is thus regulated between the set temperature and the operation suppression zone. <div data-bbox="550 1310 1013 1814" style="text-align: center;"> </div>	

No.	Item	Outline of specifications	Remarks
18	MEMORY operation	<p>Start the air conditioner in the operation mode which you want the remote control to memorize.</p> <p>(1) Press this button briefly to standby memorizing the setting. All the icons currently displayed except for the clock display and mark flashes.</p> <p>(2) Press and hold the MEMO button for more than 3 seconds while the display flashes. The mark is indicated and the setting is memorized.</p> <ul style="list-style-type: none"> • If you do not press the MEMO button within 3 seconds or if you press another button, the MEMORY setting is cancelled. • Operation modes which can be memorized with the MEMO button are MODE, Temperature, FAN, TIMER and Hi POWER. 	
19	PRESET operation	<p>To operate the air conditioner with the setting memorized by the MEMO button.</p> <p>(1) Press the PRESET button. The setting memorized with the MEMO button will be indicated and the air conditioner operates with regards to the setting.</p> <ul style="list-style-type: none"> • The lamp (green) on the display panel of the indoor unit goes on, and operation starts after approximately 3 minutes. • Initial setting: MODE : AUTO Temperature : 22 	
20	DC motor	<p>1) When the fan stator, positioning is performed for the starter and the rotor. (Vibrate slightly)</p> <p>2) DC motor operates according to the command from the indoor controller.</p> <p>(Note) If the fan lock was detected, the operation of the indoor unit stops and the error is displayed.</p>	Check code [P12]
21	Save operation	<p>1) The save operation starts when  button on the remotecontroller is turned on.</p> <p>2) While the save operation is performed,  segment goes on the screen of the wired remote controller.</p> <p>3) The request capacity ratio is restricted to approx. 75% during save operation.</p> <p>4) If the save operation was validated, the contents are held during the operation stop, the operation mode change and the resetting of power supply. Therefore the operation at the next time also will be activated with "Save operation is valid"</p>	

6. CONFIGURATION OF CONTROL CIRCUIT

6-1. Indoor Controller Block Diagram

6-1-1. Case of Main (Sub) Remote Controller Connected

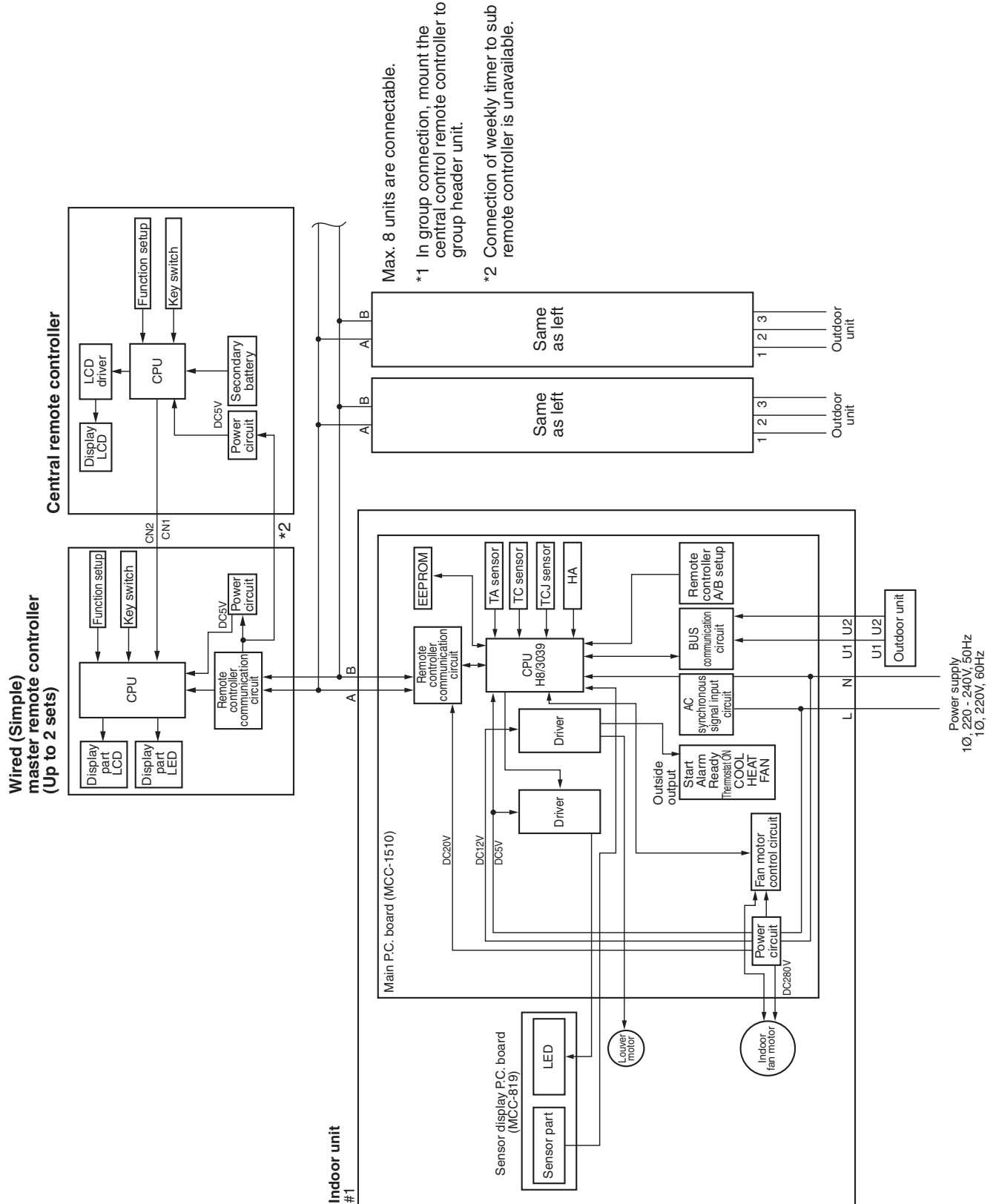

6-1-2. Case of Wireless Remote Controller Kit Connected

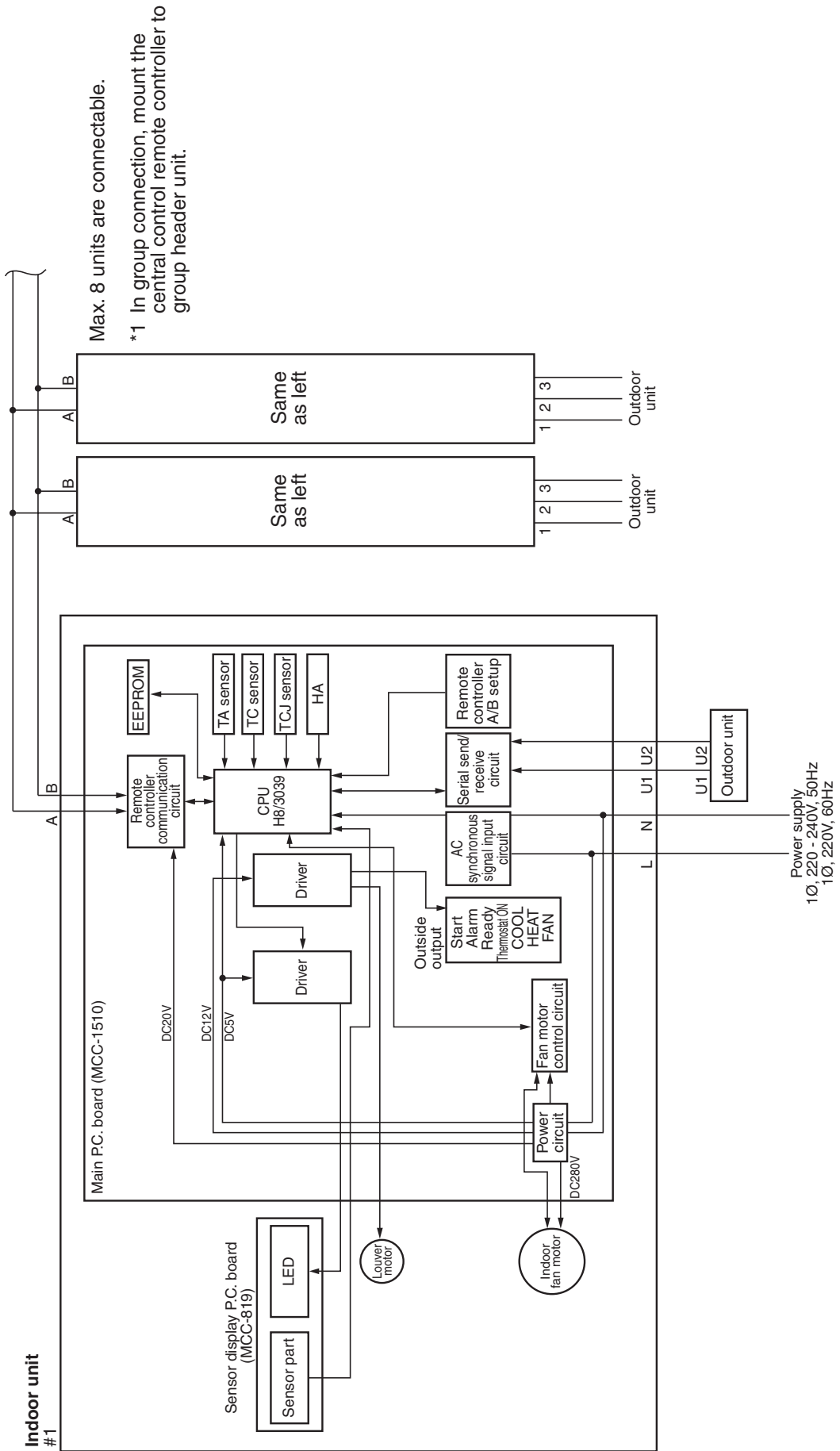

6-2. Indoor P.C. Board

MCC-1510

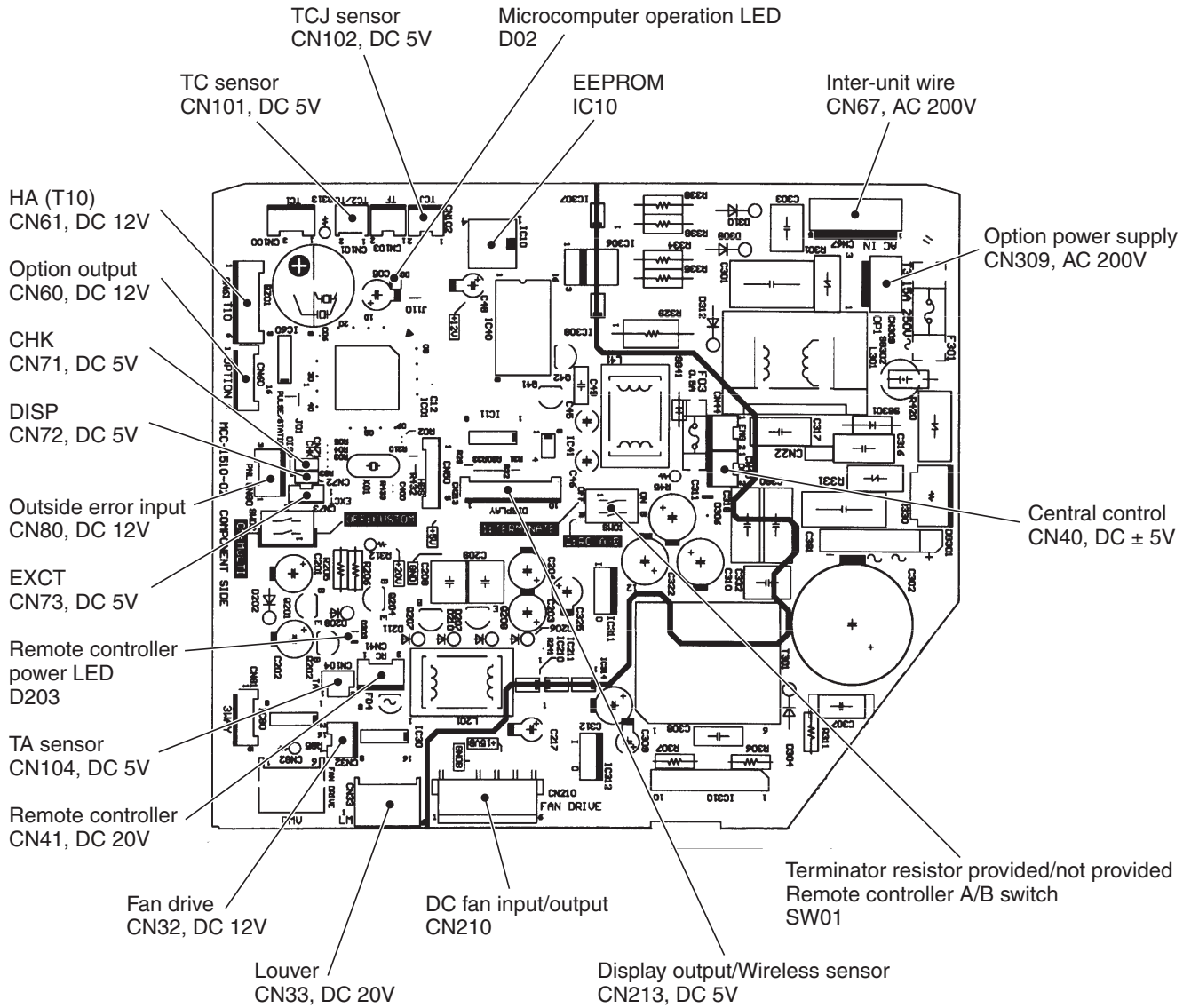

Wall-Type P.C. Board Optional Switch/Connector Specifications

Function	Connector No.	Pin No.	Specifications	Remarks
Terminator resistor provided/Not provided Remote controller A/B	SW01	Bit 1	OFF: No terminator resistor, ON: Terminator resistor provided	Setup at shipment OFF: No terminator resistor. Only 1 unit is ON during central control by custom only.
		Bit 2	OFF: Remote controller A ON: Remote controller B	Setup at shipment OFF: Remote controller A
Fan output	CN32	1	DC12V	Setup at shipment: Linked operation of ON with operation of indoor unit and OFF with stop
		2	Output	* The setup of single operation by FAN button on remote controller is executed from remote controller. (DN = 31)
HA	CN61	1	Start/Stop input	HA Start/Stop input (J01: Provided/Not provided = Pulse (At shipment from factory)/Static input switch)
		2	0V (COM)	
		3	Handy prohibition input	Operation stop of handy remote controller is permitted / prohibited by input.
		4	Operation output	ON during operation (Answer back of HA)
		5	DC12V (COM)	
		6	Alarm output	ON during output of alarm
Optional output	CN60	1	DC12V (COM)	
		2	Defrost output	ON during defrosting of outdoor unit
		3	Thermo-ON output	ON when Real thermo. ON (Comp. ON)
		4	Cooling output	ON when operation mode is cooling line (Cool, Dry, Cooling/Heating AUTO cooling)
		5	Heating output	ON when operation mode is heating line (Heat, Cooling/Heating AUTO heating)
		6	Fan output	ON when indoor fan is ON
Outside error input	CN80	1	DC12V (COM)	At shipment from factory, the error code "L30" generates and optional error input to stop operation forcedly (DN:2A = 1) is controlled (Display of protection for devices attached to outside) by setup of outside error input (DN:2A = 2) for 1 minute.
		2	DC12V (COM)	
		3	Filter/Option/Outside error input	* Optional error input control is set up on the remote controller.
CHK Operation check	CN71	1	Check mode input	This check is used for operation check of indoor unit. (The specified operation such as indoor fan "H", drain pump ON, etc. is executed without communication with outdoor unit or remote controller.)
		2	0V	
DISP Display mode	CN72	1	Display mode input	Display mode, communication is enabled by indoor unit and remote controller only. (When power supply is turned on.) Timer short (Usual)
		2	0V	
EXCT Demand	CN73	1	Demand input	Indoor unit forced thermo-OFF operation
		2	0V	

6-3. Functions at test run

■ Cooling/Heating test run check

The test run for cooling/heating can be performed from either indoor remote controller or outdoor interface P.C. board.

1. Start/Finish operation of test run

◎ Test run from indoor remote controller

- ┌ Wired remote controller: Refer to the below item of “Test run” of the wired remote controller.
- └ Wireless remote controller: Refer to the next page item of “Test run” of the wireless remote controller.

◆ In case of wired remote controller

<RBC-AMT32E>

<RBC-AMS41E>

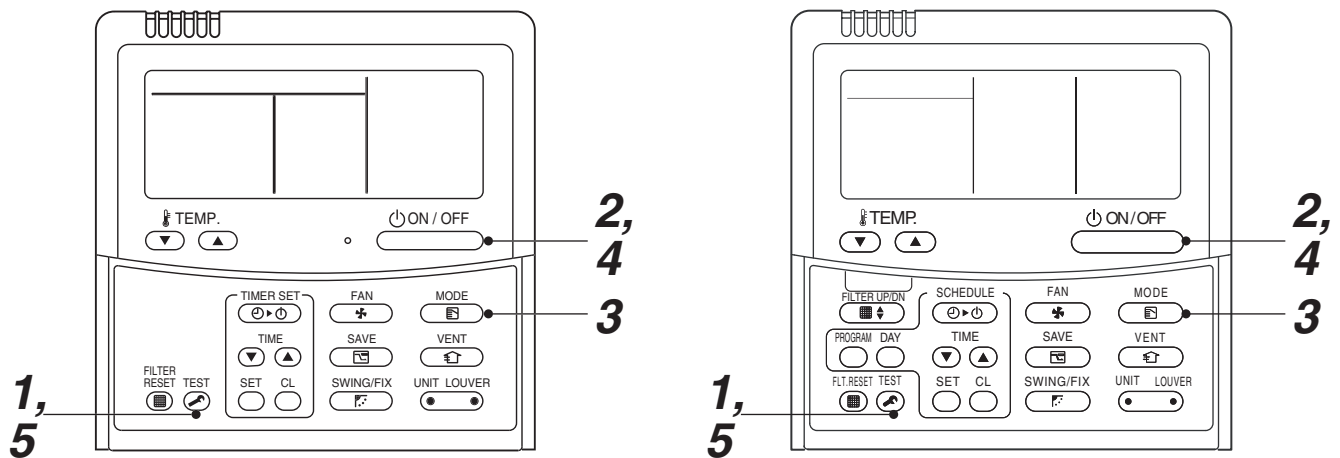

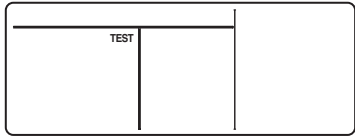
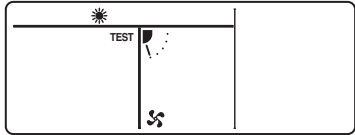
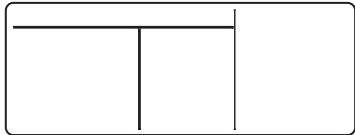
Procedure	Operation contents
1	<p>Push [TEST] button for 4 seconds or more. [TEST] is displayed at the display part and the mode enters in TEST mode.</p> 
2	<p>Push [ON/OFF] button.</p>
3	<p>Change the mode from [COOL] to [HEAT] using [MODE] button.</p> <ul style="list-style-type: none"> • Do not use [MODE] button for other mode except [COOL]/[HEAT] modes. • The temperature cannot be adjusted during test run. • The error detection is performed as usual. 
4	<p>After test run, push [ON/OFF] button to stop the operation. (Display on the display part is same to that in Procedure 1 .)</p>
5	<p>Push [TEST] button to clear the TEST mode. ([TEST] display in the display part disappears and status becomes the normal stop status.)</p> 

Note) The test run returns to the normal operation after 60 minutes.

◆ In case of wireless remote controller

REQUIREMENT

1. For the operation procedure, be sure to follow the matter.
2. Finish the forced cooling operation in a short time because it applies excessive strength to the air conditioner.
3. A test operation of forced heating is unavailable. Perform a test operation by heating operation using the switches of the remote controller.

However heating operation may be not carried out according to the temperature conditions.

• Check wiring/piping of indoor and outdoor units

1. Open the front panel.
2. When pushing “TEMPORARY” button for 10 seconds or more, “Pi!” sound is heard and the operation changes to a forced cooling operation. After approx. 3 minutes, a cooling operation starts forcedly. Check cool air starts blowing. If the operation does not start, check wiring again.
3. To stop a test operation, push “TEMPORARY” button once again (Approx. 1 second). The up/down air flow adjusting plate closes and the operation stops.

• Check transmission of remote controller

1. Push “START/STOP” button of the remote controller to check an operation can also start by the remote controller.
 - When pushing “TEMPORARY” button once (For 1 second), the operation changes to automatic operation. For a forced cooling operation, keep the “TEMPORARY” button pushed over 10 seconds.
 - “Cooling” operation by the remote controller may be unavailable according to the temperature conditions. Check wiring/piping of the indoor and outdoor units in forced cooling operation.

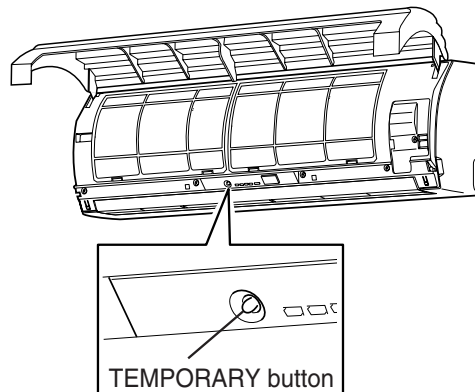

■ Check function for operation of indoor unit (Functions at indoor unit side)

This function is provided to check the operation of the indoor unit singly without communication with the remote controller or the outdoor unit. This function can be used regardless of operation or stop of the system.

However, if using this function for a long time, a trouble of the equipment may be caused. Limit using this function within several minutes.

[How to operate]

- 1) Short-circuit CHK pin (CN71 on the indoor P.C. board).

The operation mode differs according to the indoor unit status in that time.

Normal time: Both float SW and fan motor are normal.

Abnormal time: Either one of float SW or fan motor is abnormal.

- 2) Restricted to the normal time, if short-circuiting DISP pin (CN72 on the indoor P.C. board) in addition to short-circuit of CHK pin (CN71 on the indoor P.C. board), the minimum opening degree (30pls) can be set to the indoor PMV only.

When open DISP pin, the maximum opening degree (1500pls) can be obtained again.

[How to clear]

Open CHK pin. While the system is operating, it stops once but automatically returns to operation after several minutes.

	Short-circuit of CHK pin		
	Normal time		Abnormal time
	DISP pin open	DISP pin short circuit	
Fan motor	(H)	(H)	Stop
Indoor PMV (*)	Max. opening degree (1500pls)	Min. opening degree (30pls)	Min. opening degree (30pls)
Louver	Horizontal	Horizontal	Immediate stop
Drain pump	ON	ON	ON
Communication	All ignored	All ignored	All ignored
P.C. board LED	Lights	Lights	Flashes









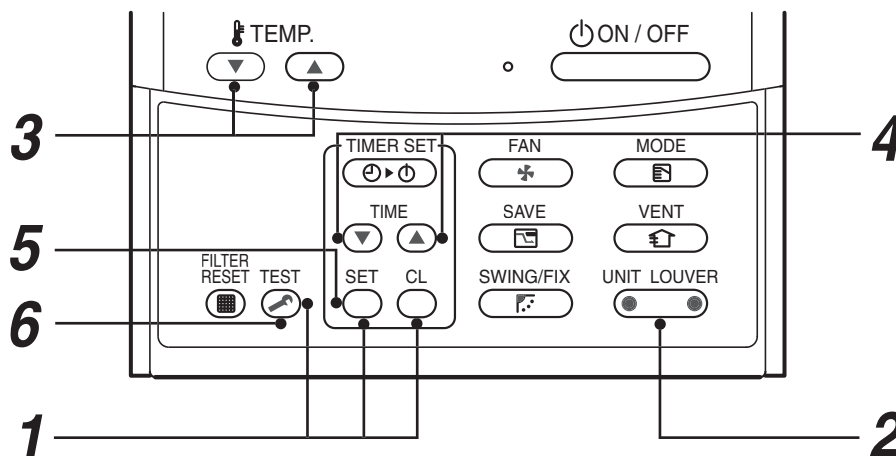

- To exchange the indoor PMV coil, set the indoor PMV to Max. opening degree.
- For the detailed positions of CHK pin (CN71 on indoor P.C. board) and DISP pin (CN72 on indoor P.C. board), refer to the indoor P.C. board MCC-1510.

7. APPLIED CONTROL

7-1. Setup of Selecting Function in Indoor Unit (Be Sure to Execute Setup by a Wired Remote Controller)

<Procedure> Execute the setup operation while the unit stops.



- 1** Push , , and  buttons simultaneously for 4 seconds or more.
The firstly displayed unit No. indicates the header indoor unit address in the group control.
In this time, the fan of the selected indoor unit is turned on.
- 2** Every pushing  button, the indoor unit numbers in the group control are successively displayed. In this time, the fan of the selected indoor unit only is turned on.
- 3** Specify the CODE No. (DN) using the setup temperature  and  buttons.
- 4** Select the setup data using the timer time  and  buttons.
(When selecting the CODE No. (DN) to “33”, change the temperature indication of the unit from “°C” to “°F” on the remote controller.)
- 5** Push  button. (OK if display goes on.)
 - To change the selected indoor unit, return to procedure **2**.
 - To change the item to be set up, return to procedure **3**.
- 6** Pushing  button returns the status to normal stop status.

CODE No. [DN]	Item	Description	At shipment
60	Timer setup (Wired remote controller)	0000 : Available (Operable) 0001 : Unavailable (Operation prohibited)	0000 : Available

TYPE

CODE No. [10]

Setup data	Type	Abbreviated Model name
*1 008	High Wall	MMK-AP XXX H

*1 : Initial setting value of EEPROM installed on the service P.C. board

Indoor unit capacity

CODE No. [11]

Setup data	Model
0001	007
0003	009
0005	012
0007	015
0009	018
0011	024

Setup data	Model
0012	027
0013	030
0015	036
0017	048
0018	056

7-2. Applied Control in Indoor Unit

■ Remote location ON/OFF control box (TCB-IFCB-4E2)

[Wiring and setup]

- Use the exclusive connector for connection with the indoor control P.C. board.
- In a group control, the system can operate when connecting with any indoor unit (Control P.C. board) in the group. However when taking out the operation/error signal from the other unit, it is necessary to take out from each unit individually.

1. Control items

- 1) Start/Stop input signal : Operation start/stop in unit
- 2) Operation signal : Output during normal operation
- 3) Error signal : Output during alarm
(Serial communication error or indoor/outdoor protective device) operation

2. Wiring diagram using remote control interface (TCB-IFCB-4E2)

Input IFCB-4E2 : No voltage ON/OFF serial signal
 Output No voltage contact for operation, error display
 Contact capacity: Below Max. AC240V 0.5A

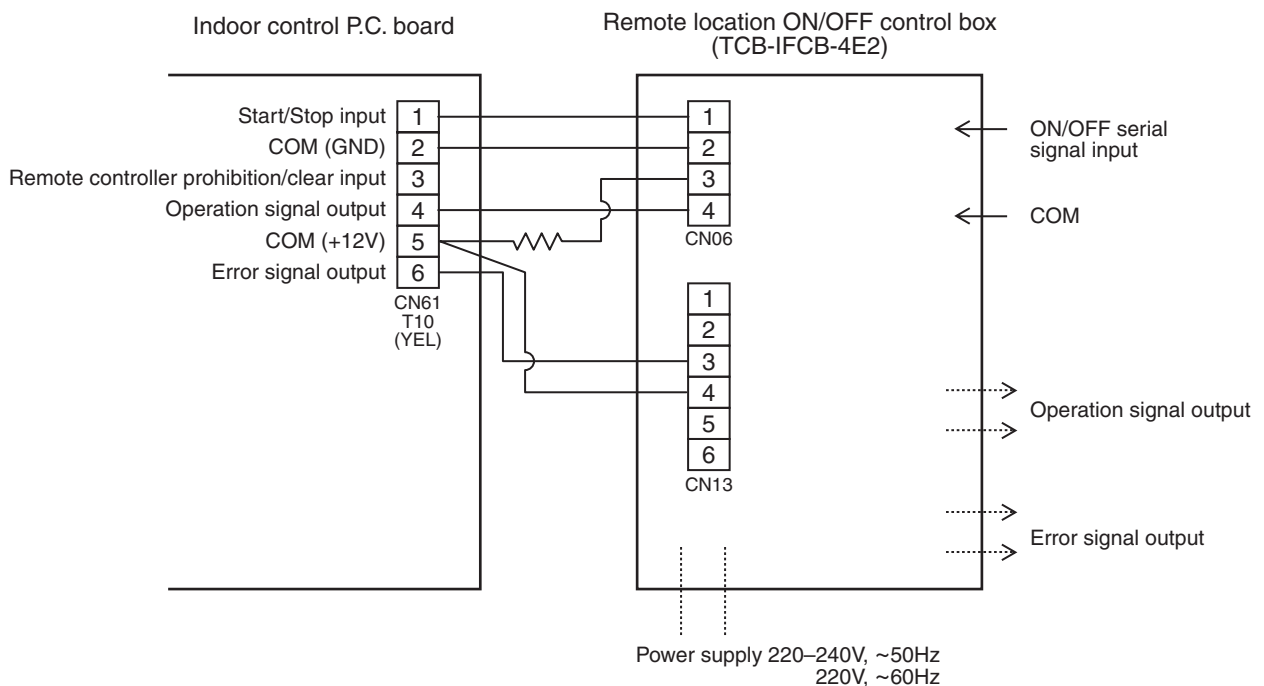

■ Ventilating fan control from wired remote controller

[Function]

- The start/stop operation can be operated from the wired remote controller when air to air heat exchanger or ventilating fan is installed in the system.
- The fan can be operated even if the indoor unit is not operating.
- Use a fan which can receive the no-voltage A contact as an outside input signal.
- In a group control, the units are collectively operated and they can not be individually operated.

1. Operation

Handle a wired remote controller in the following procedure.

- * Use the wired remote controller during stop of the system.
- * Be sure to set up the wired remote controller to the header unit. (Same in group control)
- * In a group control, if the wired remote controller is set up to the header unit, both header and follower units are simultaneously operable.

1 Push concurrently + + buttons for 4 seconds or more.

The unit No. displayed firstly indicates the header indoor unit address in the group control.

In this time, the fan of the selected indoor unit turns on.

2 Every pushing button (button at left side), the indoor unit numbers in group control are displayed successively.

In this time, the fan of the selected indoor unit only turns on.

3 Using the setup temp or button, specify the CODE No 31.

4 Using the timer time or button, select the setup data. (At shipment: 0000)

The setup data are as follows:

Setup data	Handling of operation of air to air heat exchanger or ventilating fan
0000	Unavailable (At shipment)
0001	Available

5 Push button. (OK if display goes on.)

- To change the selected indoor unit, go to the procedure 2).
- To change the item to be set up, go to the procedure 3).

6 Pushing returns the status to the usual stop status.

2. Wiring

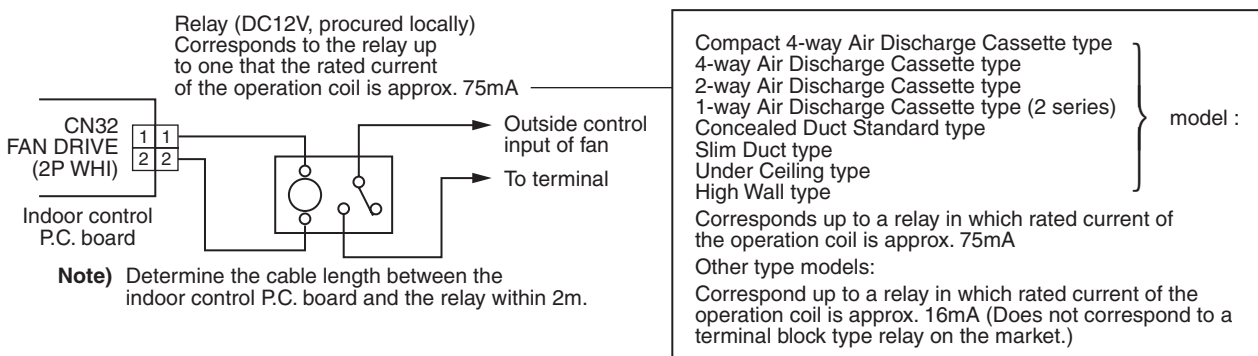

■ Leaving-ON prevention control (with Wired remote controller)

[Function]

- This function controls the indoor units individually. It is connected with cable to the control P.C. board of the indoor unit.
- In a group control, it is connected with cable to the indoor unit (Control P.C. board), and the CODE No. $\overline{2E}$ is set to the connected indoor unit.
- It is used when the start operation from outside if unnecessary but the stop operation is necessary.
- Using a card switch box, card lock, etc, the forgotten-OFF of the indoor unit can be protected.
- When inserting a card, start/stop operation from the remote controller is allowed.
- When taking out a card, the system stops if the indoor unit is operating and start/stop operation from the remote controller is forbidden.

1. Control items

- 1) Outside contact ON : The start/stop operation from the remote controller is allowed.
(Status that card is inserted in the card switch box)
 - 2) Outside contact OFF : If the indoor unit is operating, it is stopped forcibly.
(Start/Stop prohibited to remote controller)
(Status that card is taken out from the card switch box)
- * When the card switch box does not perform the above contact operation, convert it using a relay with B contact.

2. Operation

Handle the wired remote controller switch in the following procedure.

- * Use the wired remote controller switch during stop of the system.

- 1 Push concurrently SET + CL + TEST buttons for 4 seconds or more.**
- 2 Using the setup temp ∇ or \triangle button, specify the CODE No. $\overline{2E}$.**
- 3 Using the timer time ∇ or \triangle button, set 0001 to the setup data.**
- 4 Push SET button.**
- 5 Push TEST button. (The status returns to the usual stop status.)**

3. Wiring

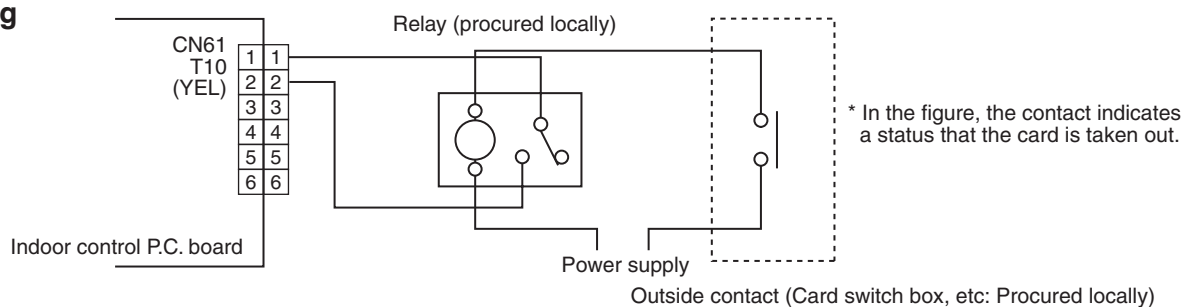

Note) Determine the cable length between the indoor control P.C. board and the relay within 2m.

■ Power peak-cut from indoor unit

When the relay is turned on, a forced thermostat-OFF operation starts.

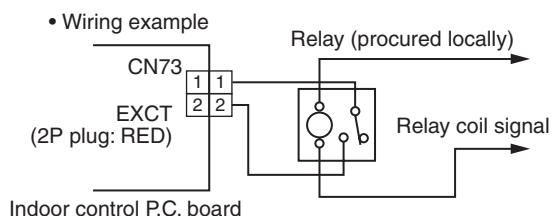

Note) Determine the cable length between the indoor or outdoor control P.C. board and the relay within 2m.

■ Address setup (Manual setting from Wired remote controller)

In case that addresses of the indoor units will be determined prior to piping work after wiring work

- Set an indoor unit per a remote controller.
- Turn on power supply.

1 Push **SET** + **CL** + **TEST** buttons simultaneously for 4 seconds or more.

2 (Line address)
Using the temperature setup ∇ / \blacktriangle buttons, set **1** to the CODE No.

3 Using timer time ∇ / \blacktriangle buttons, set the line address.

4 Push **SET** button. (OK when display goes on.)

5 (Indoor unit address)
Using the temperature setup ∇ / \blacktriangle buttons, set **1** to the CODE No.

6 Using timer time ∇ / \blacktriangle buttons, set **1** to the line address.

7 Push **SET** button. (OK when display goes on.)

8 (Group address)
Using the temperature setup ∇ / \blacktriangle buttons, set **1** to the CODE No.

9 Using timer time ∇ / \blacktriangle buttons, set **0000** to Individual, **0001** to Header unit and **0002** to follower unit.

10 Push **SET** button.
(OK when display goes on.)

11 Push **TEST** button.
Setup completes.
(The status returns to the usual stop status.)

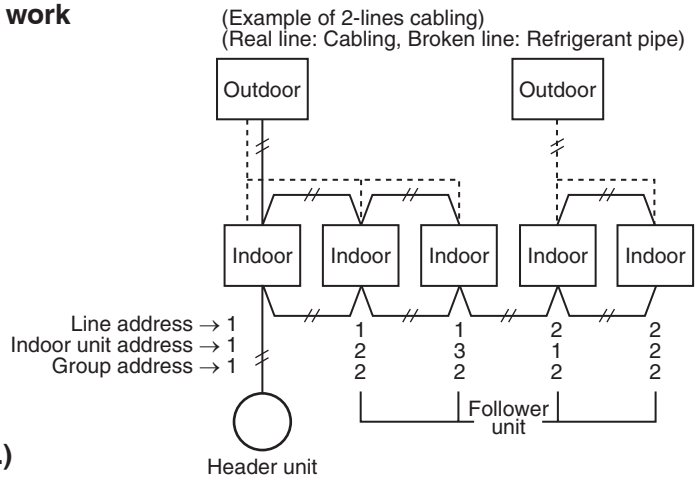

For the above example, perform setting by connecting singly the wired remote controller without remote controller inter-unit cable.

Group address
Individual : 0000
Header unit : 0001
Follower unit : 0002 } In case of group control

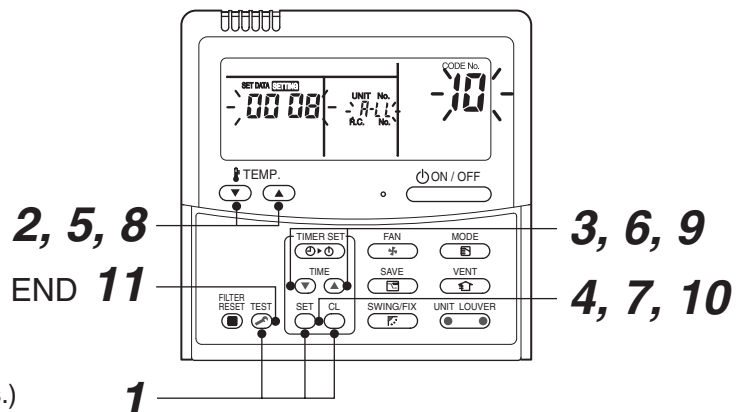

<Operation procedure>

1 → **2** → **3** → **4** → **5** → **6** →
7 → **8** → **9** → **10** → **11** END

Note 1)

When setting the line address from the wired remote controller, do not use Address 29 and 30.

As they are addresses which cannot be set to the outdoor unit, if they are set, the check code [E04] (Indoor/Outdoor communication circuit error) is issued.

Note 2)

When an address was manually set from the wired remote controller and the central control over the refrigerant lines is carried out, perform the following setting for the Header unit of each line.

- Set the line address for every line using SW13 and 14 on the interface P.C. board of the Header unit in each line.
- Except the least line address No., turn off SW30-2 on the interface P.C. board of the Header units in the lines connected to the identical central control.
(Draw the terminal resistances of indoor/outdoor and central control line wirings together.)
- For each refrigerant line, connect the relay connector between Header unit [U1U2] and [U3U4] terminals.
- After then set the central control address.
(For setting of the central control address, refer to the Installation manual for the central remote controller.)

■ Confirmation of indoor unit No. position

1. To know the indoor unit addresses though position of the indoor unit is recognized

- In case of individual operation (Wired remote controller : indoor unit = 1 : 1)
(Follow to the procedure during operation)

<Procedure>

1 Push  button if the unit stops.

2 Push  button (button at left side).

Unit No. *1-1* is displayed on LCD.

(It disappears after several seconds.)

The displayed unit No. indicate line address and indoor unit address.

(When other indoor units are connected to the identical remote controller (Group control unit), other unit numbers are also displayed every pushing  button (button at left side).

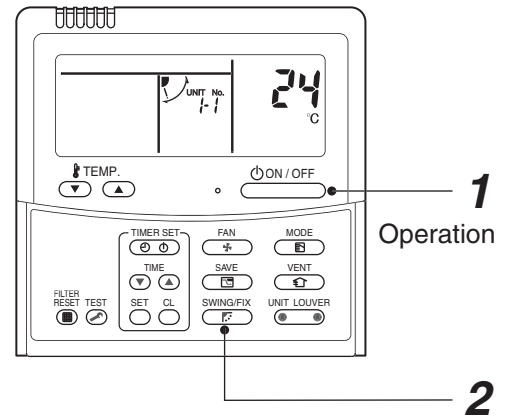

<Operation procedure>



1 → 2 END

2. To know the position of indoor unit by address

- To confirm the unit No. in the group control
(Follow to the procedure during operation) (in this procedure, the indoor units in group control stop.)

<Procedure>

The indoor unit numbers in the group control are successively displayed, and fan, louver, and drain pump of the corresponding indoor unit are turned on.
(Follow to the procedure during operation)

1 Push  and  buttons simultaneously for 4 seconds or more.

- Unit No. *ALL* is displayed.
- Fans and louvers of all the indoor units in the group control operate.

2 Every pushing  button (button at left side), the unit numbers in the group control are successively displayed.

- The unit No. displayed at the first time indicates the header unit address.
- Fan and louver of the selected indoor unit only operate.

3 Push  button to finish the procedure.
All the indoor units in the group control stop.

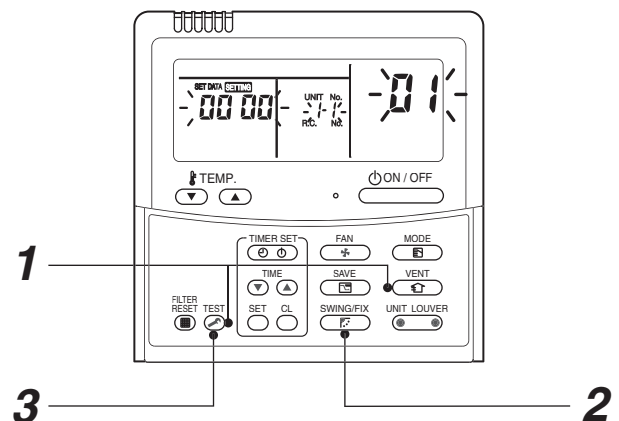

<Operation procedure>

1 → 2 → 3 END

■ Function selection setup

<Procedure> Perform setting while the air conditioner stops.

1 Push **TEST** + **SET** + **CL** buttons simultaneously for 4 seconds or more.

The first displayed unit No. is the header indoor unit address in the group control.

In this time, fan and louver of the selected indoor unit operate.



2 Every pushing **UNIT LOUVER** button (button at left side), the indoor unit No. in the group control is displayed one after the other.

In this time, fan and louver of the selected indoor unit only operate.



3 Using the set temperature **TEMP.** buttons, specify the CODE No. (DN).



4 Using the timer time **TIME** buttons, select the set data.



5 Push **SET** button. (OK if indication lights)

- To change the selected indoor unit, proceed to Procedure **2**.
- To change item to be set up, proceed to Procedure **3**.



6 Pushing **TEST** button returns the status to the normal stop status.

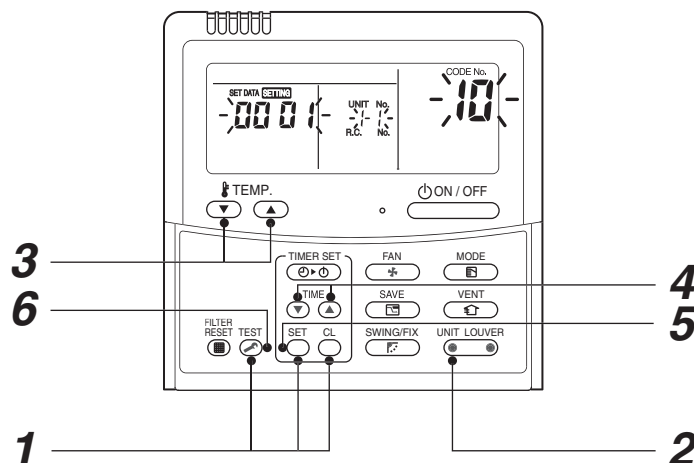

<Operation procedure>

1 → 2 → 3 → 4 → 5 → 6 END

■ How to check all the unit No. from an arbitrary wired remote controller

<Procedure> Carry out this procedure during stop of system.

The indoor unit No. and the position in the identical refrigerant piping can be checked.

An outdoor unit is selected, the identical refrigerant piping and the indoor unit No. are displayed one after the other, and then its fan and louver are on.

- 1** Push the timer time button + simultaneously for 4 seconds or more.
First line 1 and CODE No. **AL** (Address Change) are displayed. (Select outdoor unit.)



- 2** Select line address using / button.



- 3** Determine the selected line address using button.

- The address of the indoor unit connected to the refrigerant piping of the selected outdoor unit is displayed and the fan and the louver are on.



- 4** Every pushing button (button at left side), the indoor unit No. in the identical piping is displayed one after the other.

- Only fan and louver of the selected indoor unit start operation.

[To select the other line address]

- 5** Push button and the operation returns to Procedure 2.

- * The indoor address of other line can be continuously checked.



- 6** Push button and then the procedure finishes.

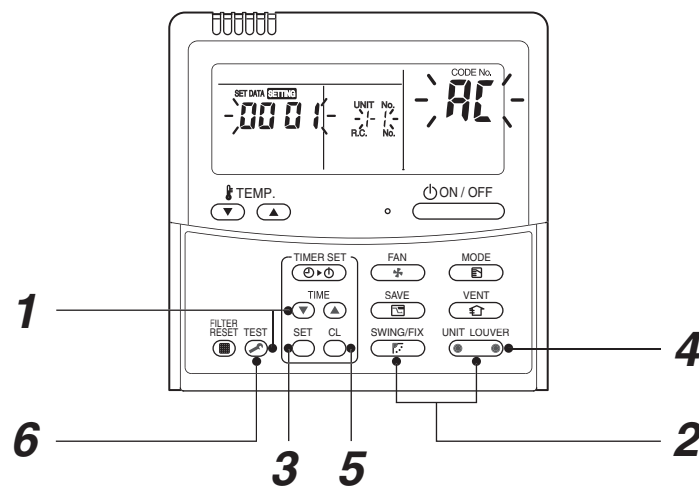

<Operation procedure>

1 → 2 → 3 → 4 → 5 → 6 END

■ How to change all indoor addresses from an arbitrary wired remote controller

(It is possible when setting has finished by automatic addresses.)

Contents: The indoor unit addresses in each identical refrigerant piping line can be changed from an arbitrary wired remote controller.

⊙ Enter in address check/change mode and then change the address.

<Procedure> Carry out this procedure during stop of system.

- 1** Push the timer time button (▼) + TEST simultaneously for 4 seconds or more.
First line 1 and CODE No. *AC* (Address Change) are displayed.



- 2** Select line address using UNIT LOUVER / SWING/FIX button.



- 3** Push the SET button.
 - The address of the indoor unit connected to the refrigerant piping of the selected outdoor unit is displayed and the fan and the louver are on.
 - First the current indoor address is displayed. (Line address is not displayed.)



- 4** TIME button push up/down the indoor address of the SET DATA.
The set data is changed to a new address.



- 5** Push SET button to determine the set data.



- 6** Every pushing UNIT LOUVER button (button at left side), the indoor unit No. in the identical piping is displayed one after the other.
 - Only fan and louver of the selected indoor unit start operation.
 - Repeat the Procedures 4 to 6 to change all the indoor addresses so that they are not duplicated.



- 7** Push SET button.
(All the indications of LCD go on.)



- 8** Push TEST button and then the procedure finishes.

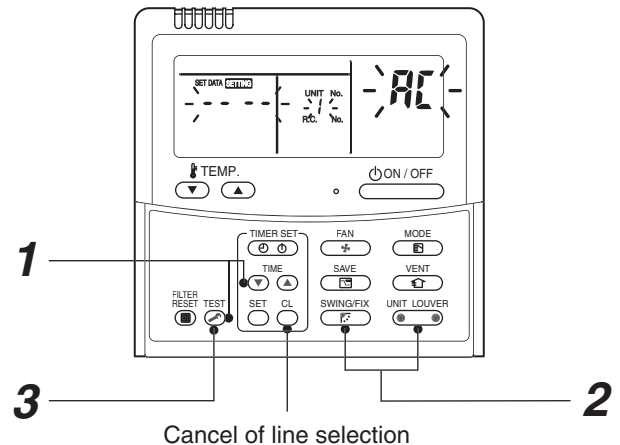

If the UNIT No. is not call up here, the outdoor unit in that line does not exist.

Push CL button to select a line again in the Procedure 2.

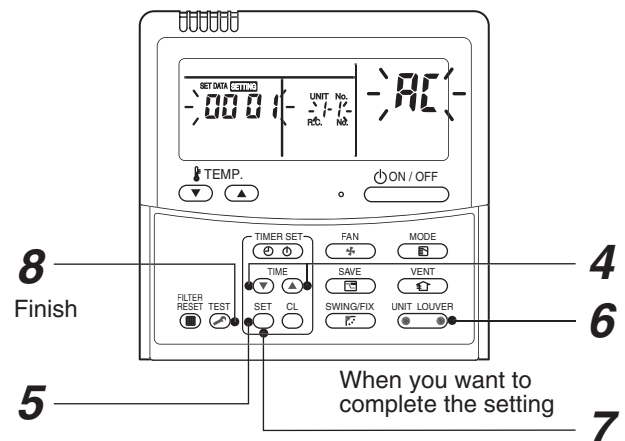

<Operation procedure>

1 → 2 → 3 → 4 → 5 →
6 → 7 → 8 END

■ Function to clear error





1. Clearing method from remote controller

⊙ How to clear error of outdoor unit

In the unit of refrigerant line connected by indoor unit of the remote controller to be operated, the error of the outdoor unit currently detected is cleared. (Error of the indoor unit is not cleared.)

The service monitor function of the remote controller is utilized.

<Method>

- 1** Push  +  buttons simultaneously for 4 seconds or more to change the mode to service monitor mode.
- 2** Push  button to set the CODE No. to [FF].
- 3** The display of A part in the following figure is counted as “0005” → “0004” → “0003” → “0002” → “0001” → “0000” with 5-seconds interval.
When “0000” appear, the error was cleared.
* However counting from “0005” is repeated on the display screen.
- 4** When pushing  button, the status becomes normal.

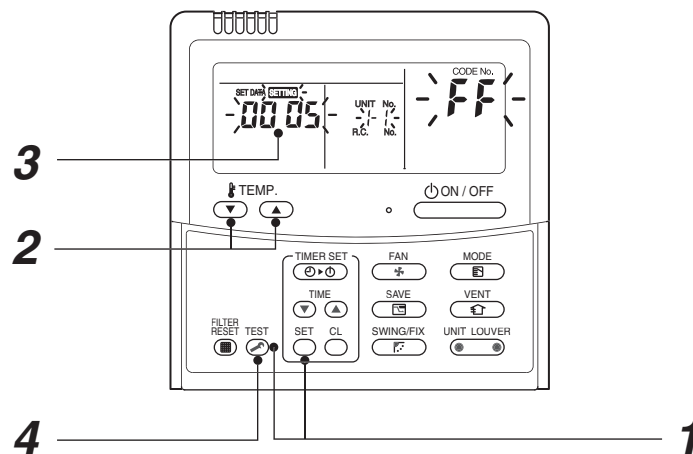

<Operation procedure>

1 → 2 → 3 → 4

Returns to normal status

⊙ How to clear error of indoor unit

The error of indoor unit is cleared by  button of the wired remote controller.

(Only error of the indoor unit connected with wired remote controller to be operated is cleared.)

■ Monitoring function of wired remote controller switch

When using the wired remote controller (Model Name: RBC-AMT32E), the following monitoring function can be utilized.

Calling of display

<Contents>

The temperature of each sensor of the wired remote controller, indoor unit and outdoor unit and the operating status can be checked by calling the service monitor mode from the wired remote controller.

<Procedure>

- 1 Push **TEST** + **CL** buttons simultaneously for 4 seconds or more to call up the service monitor mode. The service monitor goes on and firstly the temperature of the CODE No. **00** is displayed.



- 2 Push **TEMP.** button to change CODE No. to the CODE No. to be monitored. For display code, refer to the following table.



- 3 Push **UNIT LOUVER** button to change to CODE No. to be monitored. The sensor temperature of indoor unit or outdoor unit in its refrigerant line and the operating status are monitored.



- 4 Push **TEST** button to return the status to the normal display.

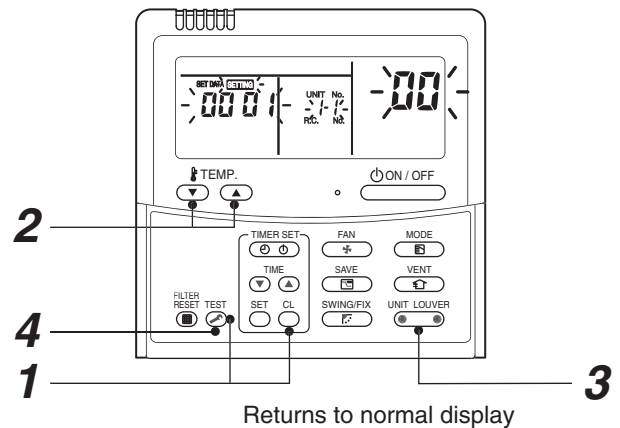

<Operation procedure>

1 → 2 → 3 → 4

	CODE No.	Data name	Unit	Display form	CODE No.	Data name	Unit	Display form	
Indoor unit data	00	Room temp. (Under control) (Note 1)	°C	× 1	Individual outdoor unit data (Note 3, 4)	10	Compressor 1 discharge temp. (Td1)	°C	× 1
	01	Room temp. (Remote controller)	°C	× 1		11	Compressor 2 discharge temp. (Td2)	°C	× 1
	02	Indoor suction temp. (TA)	°C	× 1		12	High pressure sensor detection pressure (Pd)	MPa	× 100
	03	Indoor coil temp. (TCJ)	°C	× 1		13	Low pressure sensor detection pressure (Ps)	MPa	× 100
	04	Indoor coil temp. (TC2)	°C	× 1		14	Suction temp. (TS)	°C	× 1
	05	Indoor coil temp. (TC1)	°C	× 1		15	Outdoor coil temp. (TE)	°C	× 1
	08	Indoor PMV opening degree	pls	× 1/10		16	Liquid side temp. (TL)	°C	× 1
	F2	Indoor fan accumulated operation time	h	× 100		17	Outside temp. (TO)	°C	× 1
	F3	Filter sign time	h	× 1		18	Low pressure saturation temp. (TU)	°C	× 1
	System data	0A	No. of connected indoor units	unit			19	Compressor 1 current (I1)	A
0B		Total HP of connected indoor units	HP	× 10		1A	Compressor 2 current (I2)	A	× 10
0C		No. of connected outdoor units	unit			1B	PMV1 + 2 opening degree	pls	× 1/10
0D		Total HP of connected outdoor units	HP	× 10		1D	Compressor 1, 2 ON/OFF	—	(Note 2)
						1E	Outdoor fan mode	—	0 to 31
				1F		Outdoor unit HP	HP	× 1	

(Note 1) In the group connection, only data of the header indoor unit is displayed.

(Note 2) 01: Only compressor 1 is ON.
10: Only compressor 2 is ON.
11: Both compressor 1 and 2 are ON.

(Note 3) For the CODE No., an example of header unit is described.

(Note 4) Upper girder of CODE No. indicates the outdoor unit No.

1: Header unit (A)
2: Follower unit (B)
3: Follower unit (C)
4: Follower unit (D)

8. TROUBLESHOOTING

8-1. Troubleshooting Summary

1. Before troubleshooting

1) Applied models

① S-MMS Multi type models

Indoor unit : MMX-APXXX,

Outdoor unit : MMY-MAPXXXXT8X, MMY-MAPXXXHT7X

② Super Heat Recovery Multi type models

Indoor unit : MMX-APXXX,

Outdoor unit : MMY-MAPXXXFT8X

③ Mini-S-MMS Multi type models

Indoor unit : MMX-APXXX,

Outdoor unit : MCY-MAPXXXHT, MCY-MAPXXXHT2X

2) Required tools / measuring devices

- Screwdrivers (Philips, Minus), spanner, radio pinchers, nipper, push pin for reset switch, etc.
- Tester, thermometer, pressure gauge, etc.

3) Confirmation before check (The following items are not troubles.)

No.	Operation	Check items
1	Compressor does not operate.	<ul style="list-style-type: none"> • Is not delayed for 3 minutes? (3 minutes after compressor-OFF) • Is not thermostat OFF? • Is not the fan operating or timer? • Is not the system initially communicating? Heating operation cannot be performed under condition of outside temperature 21°C or higher. Cooling operation cannot be performed under condition of outside temperature -5°C or lower.
2	Indoor fan does not work.	<ul style="list-style-type: none"> • Is not the cold draft prevention being controlled in heating operation?
3	Outdoor fan does not rotate, or fan speed changes.	<ul style="list-style-type: none"> • Is not low cooling operation being controlled? • Is not a defrost operation being performed?
4	Indoor fan does not stop.	<ul style="list-style-type: none"> • Is not after-heat elimination operation being controlled after heating operation?
5	Start/stop operation on remote controller is unavailable.	<ul style="list-style-type: none"> • Is not auxiliary unit or remote control being operated?
6	—	<ul style="list-style-type: none"> • Is connecting wire of indoor unit or remote controller correct?

2. Troubleshooting procedure

When a trouble occurred, advance the check operation in the following procedure.

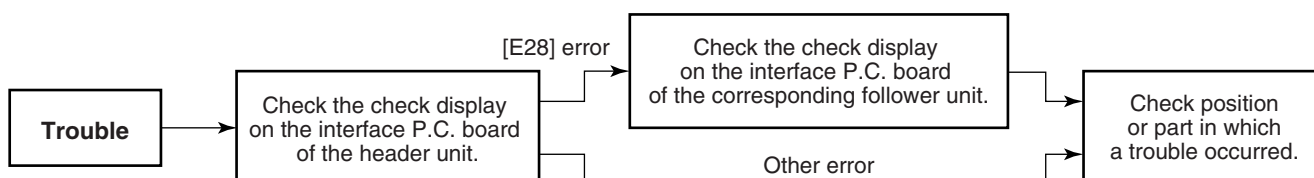

NOTE

While a check operation is performed, a malfunction of the microprocessor may be caused due to condition of the power supply or the external noise.

If there is any noise source, change wires of the remote controller and signal wires to shield wires.

8-2. HOW TO CHECK

On the remote controller (Remote controller, Central control remote controller) and on the interface P.C. board of the outdoor unit, LCD display part (Remote controller) or 7-segment display part (on outdoor interface P.C. board) is provided in order to display the operation status.

When a trouble occurred, the method to judge the trouble or defective position of the air conditioner by this self-diagnosis function is shown below.

The following table shows the list of each check code that each device detects. Check the check contents in the following table according to position to be checked.

- Check from the indoor remote controller or TCC-LINK central controller: Refer to "Display on remote controller & TCC-LINK central controller" in the following table.
- Check from outdoor unit: Refer to "Display of outdoor segment" in the following table.
- Check from indoor unit of wireless remote controller: Refer to "Sensor lamp display" in the following table.

Check code display list (Indoor unit)

[Indoor unit detects error.]

TCC-LINK central & remote controller	Check code display		Sensor lamp display			Main defective position	Description
	Outdoor 7-segment	Auxiliary code	Block display (*)	Operation	Timer		
E03	—	—	⊙	●	●	—	No communication from remote controller and network adapter (No central control system communication also)
E04	—	—	●	●	⊙	—	No communication from outdoor unit
E08	E08	Duplicated indoor unit No.	⊙	●	●	—	An address same to self address was detected.
E10	—	—	⊙	●	●	—	Communication error between MCU of main motor microprocessors
E18	—	—	⊙	●	●	—	Regular communication between header and follower units in indoor unit was impossible.
F01	—	—	⊙	⊙	●	A	Open/short of heat exchanger temp. sensor (TCU) was detected.
F02	—	—	⊙	⊙	●	A	Open/short of heat exchanger temp. sensor (TC2) was detected.
F03	—	—	⊙	⊙	●	A	Open/short of heat exchanger temp. sensor (TC1) was detected.
F10	—	—	⊙	⊙	●	A	Open/short of room temp. sensor (TA) was detected.
F11	—	—	⊙	⊙	●	A	Open/short of discharge air temp. sensor was detected.
F29	—	—	⊙	⊙	●	S	Indoor EEPROM error (Other error may be detected.)
L03	—	—	⊙	●	⊙	S	There were multiple header units in a group.
L07	—	—	⊙	●	⊙	S	There is even an indoor unit connected to group in individual indoor unit.
L08	L08	—	⊙	●	⊙	S	Indoor group address is unset. (Detected also at outdoor unit side)
L09	—	—	⊙	●	⊙	S	Capacity of indoor unit is unset.
L20	—	—	⊙	○	⊙	S	Setting of central control system address is duplicated.
L30	L30	Detected indoor unit No.	⊙	○	⊙	S	System abnormally stopped by input of external error (CN80).
P01	—	—	●	●	⊙	A	Error of indoor AC can was detected. (Fan motor thermal relay operation)
P10	P10	Detected indoor unit No.	●	●	⊙	A	Float switch operated.
P12	—	—	●	●	⊙	A	Error (Over-current, lock, etc.) of indoor DC fan was detected.
P31	—	—	⊙	●	⊙	A	Group follower unit cannot be operated by [E03/L03/L07/L08] alarm of header unit.

Note) The check code display may be different according to the detected device even same error contents such as communication error.

[Remote controller detects error.]

(*) O: Goes on, @: Flashes, ●: Goes off
 A (Alternate) : Flashing condition is alternate when there are two flashing LED.
 S (Simultaneously) : Two LED flash simultaneously when there are two flashing LED.

Remote controller	Check code display		Sensor lamp display				Main defective position	Description
	Outdoor 7-segment		Block display (*)					
	Auxiliary code	Operation	Timer	Ready	Flash	Flash		
E01	—	—	⊙	●	●	—	No remote controller header unit, remote controller communication (receive) error	When signal cannot be received from indoor unit, when header of remote controller was not set (including 2 remote controllers)
E02	—	—	⊙	●	●	—	Remote controller communication (send) error	When signal cannot be sent to indoor unit
E09	—	—	⊙	●	●	—	Duplicated remote controller header	In 2-remote controller control, both remote controllers were set to header. (Indoor header stops with alarm and follower unit continues operation.)

[Central controller detects error.]

TCC-LINK central	Check code display		Sensor lamp display				Main defective position	Description
	Outdoor 7-segment		Block display (*)					
	Auxiliary code	Operation	Timer	Ready	Flash	Flash		
C05	—	—	—	—	—	—	Central control system communication (send) error	When signal of central control system cannot be sent, there are same multiple central devices (AI-NET)
C06	—	—	—	—	—	—	Central control system communication (receive) error	When signal of central control system cannot be received
—	—	—	—	—	—	—	There are multiple network adapters.	There were multiple network adapters (AI-NET) on remote controller communication line.
C12	—	—	—	—	—	—	Batched alarm of interface for general-purpose equipment control	Error of equipment connected to control interface of the general-purpose unit exclusive to TCC-LINK/AI-NET
P30	—	—	—	—	—	—	Group follower unit error	Group follower unit error (For remote controller, [*:#] details is displayed together with unit No.)

Note) The check code display may be different according to the detected device even same error contents such as communication error.

Check code display list (Outdoor unit)

[SMMS-i interface detects error: Main example]

(*) O : Goes on, ◎ : Flashes, ● : Goes off
 A (Alternate) : Flashing condition is alternate when there are two flashing LED.
 S (Simultaneously) : Two LED flash simultaneously when there are two flashing LED.

	Check code display		TCC-LINK central & remote controllers	Sensor lamp display			Main defective position	Description
	Outdoor 7-segment			Block display	Ready	Flash		
	Auxiliary code	No. of indoor units which received signal normally						
E06			E06	●	◎		Decrease of quantity of indoor units	No communication from indoor unit (Decrease of connected indoor units)
E07			(E04)	●	◎		Indoor/Outdoor communication circuit error	Signal cannot be sent to indoor unit (→There is no communication from outdoor unit.)
E08			(E08)	◎	●		Duplicated indoor address	There are multiple indoor units having the same address. (Detected also at indoor unit side)
E12			E12	◎	●		Automatic address start error	Automatic indoor address operation while setting automatic address of other system
E15			E15	●	◎		There is none during auto addressing.	Outdoor automatic address operation while setting automatic indoor address
E16			E16	●	◎		No. of connected indoor units: Over capacity	There is no signal receiving from outdoor unit during automatic addressing.
E19			E19	●	◎		No. of center outdoor units error	Total capacity of indoor units exceeded (total capacity of outdoor units × 135%)
E20			E20	●	◎		Connected to other line during automatic addressing	There is no center outdoor unit or there are 2 or more outdoor units in 1 line.
E21			E21	●	◎		Header heat unit quantity error	Indoor unit of other line was detected during automatic address is been setting.
E22			E22	●	◎		Decrease of heat unit quantity	There is no header heat unit in the system, or there are multiple header units.
E23			E23	●	◎		Send error communication between outdoor units	No communication from heat unit (Decrease of connected heat units)
E25			E25	●	◎		Duplicated terminal outdoor address setting	Sending to other outdoor is unavailable.
E26			E26	●	◎		Decrease of connected outdoor units	Manually set outdoor address was duplicated.
E28			E28	●	◎		Terminal outdoor error	No communication from terminal outdoor unit (Decrease of connected terminal outdoor units)
E31			E31	●	◎		IPDU communication error	Center outdoor unit detected terminal outdoor unit error. (For terminal outdoor unit, details are displayed.)
F04			F04	◎	◎	A	Outdoor discharge temp. sensor (TD1) error	Open/Short of outdoor discharge temp. sensor (TD1) was detected.
F05			F05	◎	◎	A	Outdoor discharge temp. sensor (TD2) error	Open/Short of outdoor discharge temp. sensor (TD2) was detected.
F06			F06	◎	◎	A	Outdoor heat exchanger temp. sensor (TE1, TE2) error	Open/Short of heat exchanger temp. sensor (TE1, TE2) was detected.
F07			F07	◎	◎	A	Outdoor liquid temp. sensor (TL) error	Open/Short of outdoor liquid temp. sensor (TL) was detected.
F08			F08	◎	◎	A	Outdoor outer air temp. sensor (TO) error	Open/Short of outer air temp. sensor (TO) was detected.
F11			F11	◎	◎	A	Outdoor suction temp. sensor (TS1) error	Open/Short of outdoor suction temp. sensor (TS1) was detected.
F15			F15	◎	◎	A	Outdoor temp. sensor (TE1, TL) miswiring	Miswiring by temp. sensor (TE1, TL) was detected.
F16			F16	◎	◎	A	Outdoor pressure sensor (Pd, Ps) miswiring	Miswiring by outdoor pressure sensor (Pd, Ps) was detected.
F22			F22	◎	◎	A	Outdoor discharge temp. sensor (TD3) error	Open/Short of outdoor discharge temp. sensor (TD3) was detected.
F23			F23	◎	◎	A	Low pressure (Ps) sensor error	Output voltage of low pressure (Ps) sensor detected 0.
F24			F24	◎	◎	A	High pressure (Pd) sensor error	Output voltage of high pressure (Pd) sensor detected 0 or error value was detected during stop of compressor.
F31			F31	◎	◎	S	Outdoor EEPROM error	Outdoor EEPROM error (Center unit stops alarm and terminal unit continues operation.)

(*) O : Goes on, ◎ : Flashes, ● : Goes off
 A (Alternate) : Flashing condition is alternate when there are two flashing LED.
 S (Simultaneously) : Two LED flash simultaneously when there are two flashing LED.

Check code display		TCC-LINK central & remote controllers	Sensor lamp display			Main defective position	Description
Outdoor 7-segment Auxiliary code	Operation		Timer	Ready	Flash		
H05	—	H05	●	◎	—	Outdoor discharge temp. sensor (TD1) miswiring	Miswiring or mismounting of outdoor discharge temp. sensor (TD1) or coming-out of TD1 sensor was detected.
H15	—	H15	●	◎	—	Outdoor discharge temp. sensor (TD2) miswiring	Miswiring or mismounting of outdoor discharge temp. sensor (TD2) or coming-out of TD2 sensor was detected.
H25	—	H25	●	◎	—	Outdoor discharge temp. sensor (TD3) miswiring	Miswiring or mismounting of outdoor discharge temp. sensor (TD3) or coming-out of TD3 sensor was detected.
H06	—	H06	●	◎	—	Low pressure protective operation	Protection by low pressure (Ps) sensor was detected.
H07	—	H07	●	◎	—	Protection for oil level drop	Protection detection by temp. sensor (TK1 to 5) for oil level detection.
H08	01: TK1 sensor error 02: TK2 sensor error 03: TK3 sensor error 04: TK4 sensor error 05: TK5 sensor error	H08	●	◎	—	Oil level detection temp. sensor (TK1 to 5) error	Open/Short of temp. sensor (TK1 to 5) for oil level detection was detected.
H16	01: TK1 Oil circuit system error 02: TK2 Oil circuit system error 03: TK3 Oil circuit system error 04: TK4 Oil circuit system error 05: TK5 Oil circuit system error	H16	●	◎	—	Detection circuit error	After starting compressor operation, temperature change of temp. sensor (TK1 to 5) for oil level detection was not detected.
L04	—	L04	◎	○	◎	Duplicated outdoor system address	Duplicated setting of system address to outdoor units of different refrigerant piping system
L05	No. of preceded indoor units (L05/L06) by individual display)	L05	◎	●	◎	Duplicated priority indoor units (Displayed in priority indoor unit)	Duplicated priority indoor units (For priority indoor unit)
L06	—	L06	◎	●	◎	Duplicated priority indoor units (Displayed except priority indoor unit)	Duplicated priority indoor units (For indoor units without priority)
L08	—	L08	◎	●	◎	Unset indoor group address	There is indoor unit which indoor group address was not set (Detected also at indoor unit side)
L10	—	L10	◎	○	◎	Unset outdoor unit capacity	Capacity of outdoor unit is not set. (Exchange service P.C. board.)
L17	—	L17	◎	○	◎	Disagreed error of outdoor model	Former model of outdoor unit (Before 3 series) was connected.
L18	—	L18	◎	○	◎	Refrigerant change unit system error	COOL/HEAT cycle error by mispiping, etc was detected.
L26	No. of connected heat units	L26	◎	○	◎	No. of connected heat unit over	There are 3 or more connected heat units.
L27	No. of connected heat units	L27	◎	○	◎	No. of connected heat unit error	Heat unit was not connected, or combination of No. of outdoor units with No. of heat units defective.
L28	—	L28	◎	○	◎	No. of connected outdoor units over	No. of connected outdoor units exceeded 4 units
L29	A9-IPDU 1 2 3 FAN IPDU A3-IPDU 1 2 3 FAN IPDU 01: O 0A O O O 02: O 0B O O O 03: O 0C O O O 04: O 0D O O O 05: O 0E O O O 06: O 0F O O O 07: O O O O O 08: O O O O O 09: O O O O O mark: Error position.	L29	◎	○	◎	IPDU quantity error	No. of IPDU (P.C. board) in inverter box is few.
L30	Detection of indoor unit number	(L30)	◎	○	◎	Outside error input in indoor (interlock)	There is indoor unit which abnormally stops by outer error input in 1 system. (← Indoor unit detected.)
P03	00: Open phase shortage detection 01: Compressor 1 side 02: Compressor 2 side 03: Compressor 3 side	P03	◎	●	◎	Outdoor unit discharge (TD1) temp. error	High temp. error was detected at outdoor discharge temp. sensor (TD1).
P05	00: Open phase shortage detection 01: Compressor 1 side 02: Compressor 2 side 03: Compressor 3 side	P05	◎	●	◎	Open phase shortage_Power failure error Inverter DC voltage (Vdc) error	When power supply was turned on, open phase shortage was detected. Over current/Current shortage was detected at inverter DC voltage.

(*) O : Goes on, @ : Flashes, ● : Goes off
 A (Alternate) : Flashing condition is alternate when there are two flashing LED.
 S (Simultaneously) : Two LED flash simultaneously when there are two flashing LED.

Check code display		Sensor lamp display		Main defective position	Description		
		TCC-LINK central & remote controllers	Block display				
Outdoor 7-segment	Auxiliary code	Operation	Timer	Ready	Flash		
P07	01: Compressor 1 side 02: Compressor 2 side 03: Compressor 3 side	P07	●	◎	A	Heat sink overheat error	High temp. error was detected in outdoor (GBT built-in temp. sensor (TH)).
P09	Detection of heat unit number	(P09)	●	◎	A	Heat unit water-shortage error	There is heat unit which was been detected water-shortage in 1 system. (← Heat unit detected.)
P10	Detection of indoor unit number	(P10)	●	◎	A	There is indoor unit which overflow was detected.	There is abnormally stopped indoor unit which was been detected water-overflow in 1 system. (← Indoor unit detected.)
P13	—	P13	●	◎	A	Outdoor liquid back detection error	Liquid back operation was judged from refrigerant cycle status.
P15	01: TS condition 02: TD condition	P15	◎	●	A	Gas leak detection	Outdoor suction temp. sensor (TS1) continuously and repeatedly detected high temperature over standard value.
P17	—	P17	◎	●	A	Outdoor discharge (TD2) temp. error	High temp. error was detected in outdoor discharge temp. sensor (TD2).
P18	—	P18	◎	●	A	Outdoor discharge (TD3) temp. error	High temp. error was detected in outdoor discharge temp. sensor (TD3).
P19	Detection of outdoor unit number	P19	◎	●	A	4-way valve invert error	Refrigerant cycle error was detected in heating operation.
P20	—	P20	◎	●	A	High pressure protection operation	High pressure (Pc) sensor detected pressure over standard value.
P24	Detection of heat unit number	P24	◎	●	A	Heat unit error (Main code)	Heat unit detected error (Heat remote controller displays detailed check code together with model number.)

Check code display list (Outdoor unit)

[SMMS-i unit IPDU detects error: Main example]

(*) O: Goes on, @: Flashes, ●: Goes off
 A (Alternate) : Flashing condition is alternate when there are two flashing LED.
 S (Simultaneously) : Two LED flash simultaneously when there are two flashing LED.

Check code display		TCC-LINK central & remote controllers	Sensor lamp display			Main defective position	Description	
Outdoor 7-segment	Auxiliary code		Block display		Flash			
			Operation	Timer	Ready			
F13	01: Compressor 1 side 02: Compressor 2 side 03: Compressor 3 side	F13	◎	◎	○	A	Outdoor IGBT built-in temp. sensor (TH) error	Open/Short of outdoor unit IGBT built-in temp. sensor (TH) was detected.
H01	01: Compressor 1 side 02: Compressor 2 side 03: Compressor 3 side	H01	●	◎	●		Compressor break down	Inverter current (Idc) detection circuit detected over-current.
H02	01: Compressor 1 side 02: Compressor 2 side 03: Compressor 3 side	H02	●	◎	●		Compressor error (Lock)	Compressor lock was detected.
H03	01: Compressor 1 side 02: Compressor 2 side 03: Compressor 3 side	H03	●	◎	●		Current detection circuit error	Abnormal current was detected during stop of compressor.
P04	01: Compressor 1 side 02: Compressor 2 side 03: Compressor 3 side	P04	◎	●	◎	A	High pressure SW system operation	High pressure SW operated.
P07	01: Compressor 1 side 02: Compressor 2 side 03: Compressor 3 side	P07	◎	●	◎	A	Heat sink overheat error	High temp. error was detected in outdoor IGBT built-in temp. sensor (TH).
P22	0*: IGBT circuit 1*: Position detection circuit error 3*: Motor lock error 4*: Motor current detection C*: TH sensor error D*: TH sensor error E*: Inverter DC voltage error (Outdoor fan) Note In position *, 0 to F is displayed, but ignore it.	P22	◎	●	◎	A	IPDU for outdoor fan error	IPDU for outdoor fan detected each error.
P26	01: Compressor 1 side 02: Compressor 2 side 03: Compressor 3 side	P26	◎	●	◎	A	G-Tr (IGBT) short-circuit protection error	Short-circuit protective operation (Instantaneous over-current) of compressor motor driving circuit element operated.
P29	01: Compressor 1 side 02: Compressor 2 side 03: Compressor 3 side	P29	◎	●	◎	A	Compressor position detection circuit system error	Position detection error of compressor motor was detected.

Note The above check codes are the representative examples and they differ according to the combined outdoor units (Cooling/Heating flex, etc.).
 For details, refer to the Service Manual for the corresponding outdoor unit.

8-3. Troubleshooting by Check Display on Wired Remote Controller

■ In case of wired remote controller (RBC-AMT32E)

1. Confirmation and check

When an error occurred on the air conditioner, the check code and the indoor unit No. are displayed on the display section of the remote controller.

The check code is displayed while the air conditioner operates.

If the display disappeared, operate the air conditioner and check the error based upon the following "Confirmation of error history".

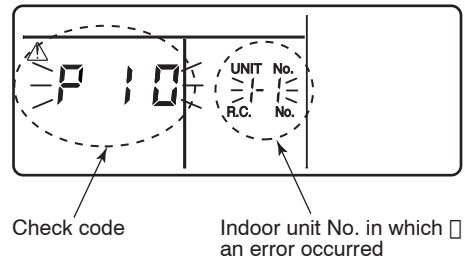

2. Confirmation of error history

When an error occurred on the air conditioner, the error history can be confirmed with the following procedure.

(Up to 4 error histories are stored in memory.)

This history can be confirmed from either operating status or stop status.

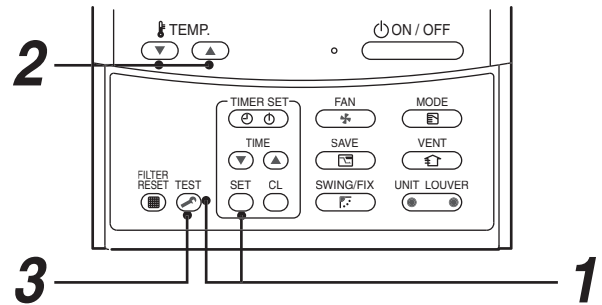

Procedure	Description
1	<p>When pushing SET and TEST buttons simultaneously for 4 seconds or more, the below display appears. If [Service Check] is displayed, the mode enters in the error history mode.</p> <ul style="list-style-type: none"> • [01: Error history order] is displayed in CODE No. window. • [Check Code] is displayed in check code window. • [Indoor unit address with error] is displayed in UNIT No.
2	<p>Every pushing temp. set (down/up) buttons, the error histories stored in the memory are displayed in order. The numbers in CODE No. indicates CODE No. [01] (Latest) to [04] (Oldest).</p> <p>CAUTION Do not push CL button because all the error histories of the indoor unit will be deleted.</p>
3	<p>After confirmation, push TEST button to return to the usual display.</p>

How to read the check monitor display

<7-segment display>



<How to read>

0 1 2 3 4 5 6 7 8 9 A b C d E F H J L P

■ In case of central remote controller (TCB-SC642TLE2)

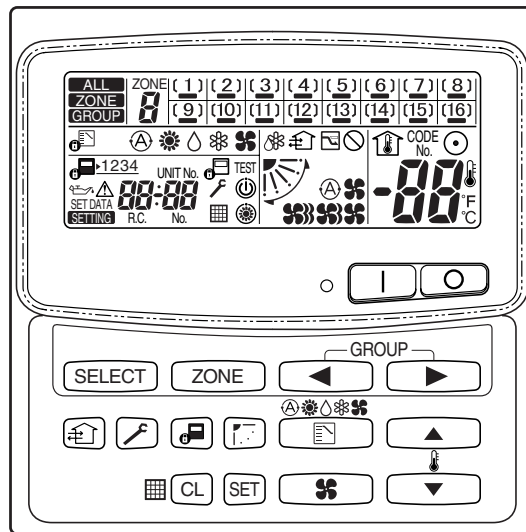

1. Confirmation and check

When a trouble occurred on the air conditioner, the check code and the indoor unit No. are displayed on the display section of the remote controller.

The check code is displayed while the air conditioner operates.

If the display disappeared, operate the air conditioner and check the error based upon the following "Confirmation of error history".

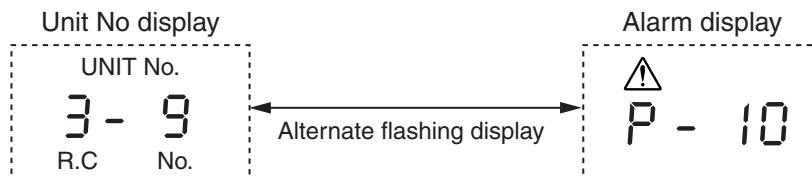

2. Confirmation of error history

When a trouble occurred on the air conditioner, the error history can be confirmed with the following procedure. (Up to 4 error histories are stored in memory.)

This history can be confirmed from either operating or stop.

- 1) Push and buttons in succession for 4 seconds or more.
- 2) SERVICE CHECK goes on and CODE No. 01 goes on.
- 3) When selecting (flash) the group number if there is the alarm history, the UNIT number and the latest alarm history are displayed alternately.
 - * In this time, the temperature cannot be set up.
- 4) To confirm the alarm history other than the latest one, push temp. set / to select CODE No. (01 to 04).
- 5) To confirm the alarm in the other group, push and to select the group number. Do not push button because all the alarm histories of the currently selected group are deleted.
- 6) To finish the service check, push button.

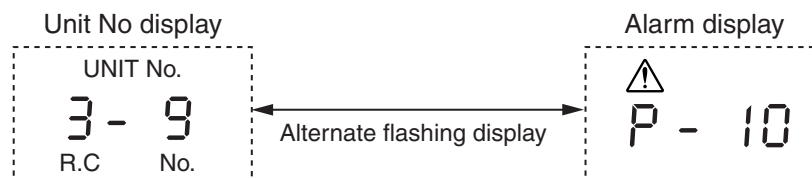





■ Indoor unit display part (Receiving unit) (Wireless type)

When specifying the check code, check 7-segment display on the center unit.

For the check code which is not displayed on the outdoor 7-segment, confirm it in Section “8-2 How to Check / Check code display list (Indoor unit)”.

● : Goes off, ○ : Goes on, ☀ : Flash (0.5 second)

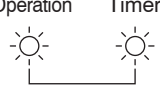
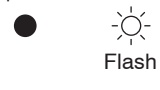
Lamp indication	Check code	Cause of trouble occurrence	
Operation Timer Ready ● ● ● No indication at all	—	Power supply OFF or miswiring between receiving unit and indoor unit	
Operation Timer Ready ☀ ● ● Flash	E01	Receiving error } Receiving unit } Miswiring or wire connection error Sending error } } between receiving unit and indoor unit Communication interruption	
	E02		
	E03		
		E08	Duplicated indoor unit No. (Address) } Duplicated header units of remote controller } Setup error
		E09	
		E10	Communication error between MCU on indoor unit P.C. board
		E12	Automatic address start error
		E18	Wire connection error between indoor units, indoor power supply OFF
Operation Timer Ready ● ● ☀ Flash		E04	Miswiring or wire connection error between indoor unit and outdoor unit (Communication interruption between indoor and outdoor units)
	E06	Communication (receiving) error between indoor and outdoor units, decrease of No. of connected indoor units	
	E07	Communication (sending) error between indoor and outdoor units	
	E15	No indoor unit during setting of automatic address	
	E16	No. of connected indoor units, capacity over	
	E19	Error of No. of header unit	
	E20	Disagreement of refrigerant pipe communication during setting of automatic address	
	E23	Communication (sending) error between outdoor units	
	E25	Duplicated setting of follower unit address	
	E26	Communication (receiving) error between outdoor units, decrease of No. of connected outdoor units	
	E28	Follower unit error	
	E31	IPDU communication error	
	Operation Timer Ready ● ☀ ☀ Alternate flash	P01	Indoor fan error
P10		Indoor overflow error	
P12		Indoor fan error	
P13		Outdoor unit liquid back detection error	
Operation Timer Ready ☀ ● ☀ Alternate flash	P03	Outdoor unit discharge temp. (TD1) error	
	P04	Outdoor unit high pressure switch operation	
	P05	Outdoor unit inverter DC voltage (Vdc) error was detected, negative phase error was detected	
	P07	Outdoor unit heat sink overheat error: Heat radiation error of electric part (IGBT) in outdoor unit	
	P15	Gas leak was detected: Short of refrigerant charge amount	
	P17	Outdoor unit discharge temp. (TD2) error	
	P18	Outdoor unit discharge temp. (TD3) error	
	P19	Outdoor unit 4-way valve inverse error	
	P20	High pressure protection error	
	P22	Outdoor unit DC fan error	
	P26	Outdoor unit G-Tr short-circuit error	
	P29	Compressor position detection circuit error	
	P31	Other indoor unit stopped due to error in the group.	

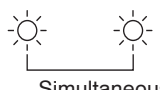
Lamp indication	Check code	Cause of trouble occurrence
Operation Timer Ready  Alternate flash	F01	Heat exchanger sensor (TCJ) error Heat exchanger sensor (TC2) error Heat exchanger sensor (TC1) error Room temp. sensor (TA) error Discharge air temp. sensor (TF) error } Temp. sensor error in indoor unit
	F02	
	F03	
	F10	
	F11	
Operation Timer Ready  Alternate flash	F04	Discharge temp. sensor (TD1) error Discharge temp. sensor (TD2) error Heat exchanger sensor (TE1, TE2) error Liquid temp. sensor (TL) error Outside temp. sensor (TO) error Suction temp. sensor (TS1) error Heat sink sensor (TH) error } Outdoor unit temp. sensor error
	F05	
	F06	
	F07	
	F08	
	F12	
	F13	
	F15	Misconnection of heat exchanger sensor (TE) with liquid temp. sensor (TL) → Miswiring of temp. sensor in outdoor unit or miss-mounting
	F16	Miswiring between high pressure sensor (Pd) and low pressure sensor (Ps) → Misconnection of pressure sensor in outdoor unit
		F22
F23		
F24		
Operation Timer Ready  Simultaneous flash	F29	Indoor unit EEPROM error
Operation Timer Ready  Flash	H01	Compressor break-down Compressor lock Current detection circuit error } Outdoor unit compressor system error
	H02	
	H03	
	H04	Compressor 1 case thermo operation
	H05	Miswiring or mismounting of outdoor discharge temp. sensor (TD1) or coming-off of TD1 sensor
	H06	Low pressure (Ps) drop error Oil face drop detection error } Protections stop of outdoor unit
	H07	
	H08	Oil face detection circuit system temp. sensor (TK1, TK2, TK3, TK4, TK5) error
	H15	Miswiring or mismounting of outdoor discharge temp. sensor (TD2) or coming-off of TD2 sensor
	H16	Oil face detection circuit system error: Outdoor unit TK1, TK2, TK3, TK4 circuit system error
H25	Miswiring or mismounting of outdoor discharge temp. sensor (TD3) or coming-off of TD3 sensor	
Operation Timer Ready  Simultaneous flash	L03	Duplicated header units in indoor unit
	L05	Duplicated priority indoor unit (Displayed in the room with priority)
	L06	Duplicated priority indoor unit (Displayed in a room except one with priority)
	L07	Group cable was connected to individual indoor unit.
	L08	Indoor group address was unset.
	L09	Indoor capacity was unset.
Operation Timer Ready  Simultaneous flash	L04	Duplicated setting of outdoor line address
	L10	Outdoor capacity was unset.
	L17	Disagreement error of outdoor unit type
	L18	Flow selector unit error
	L20	Duplicated address of central control system
	L28	No. of connected outdoor units over
	L29	Defective No. of IPDU
L30	Indoor unit outside interlock error	
Operation Timer Ready  Simultaneous flash	F31	Outdoor unit EEPROM error

■ Others (Except check code)

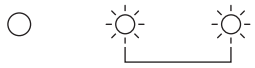
Lamp indication	Check code	Cause of trouble occurrence
Operation Timer Ready  Simultaneous flash	—	During test run
Operation Timer Ready  Alternate flash	—	COOL/HEAT disagreement (Automatic cooling/heating setup to automatic cooling/heating unavailable model, heating setup to cooling only model)

8-4. Check Code and Check Position Displayed on the Remote Controller and Outdoor Unit (7-Segment Display of Interface)

<In case of SUPER MODULAR MULTI SYSTEM>

Wired remote controller	Check code		Detected position	Check code name	Status	Error detection condition	Check item (position)
	Check code	Outdoor 7-segment display Auxiliary code					
E01	—	—	Remote controller	Communication error between indoor and remote controller (Detected at remote controller side)	Corresponding unit only stops.	Communication interrupted between indoor P.C. board and remote controller.	<ul style="list-style-type: none"> Check remote controller inter-unit cable (A/B). Check disconnection, connector contact error. Check indoor power supply. Check indoor P.C. board error. Check remote controller address setup. (When two remote controllers operate) Check remote controller P.C. board.
E02	—	—	Remote controller	Remote controller sending error	Corresponding unit only stops.	Signal could not be sent from remote controller to indoor unit.	<ul style="list-style-type: none"> Check the communication wire of remote controller: Exchange remote controller.
E03	—	—	Indoor unit	Communication error between indoor and remote controller (Detected at indoor side)	Corresponding unit only stops.	No communication from remote controller (including wireless) and communication adapter.	<ul style="list-style-type: none"> Check remote controller and communication adapter wiring.
E04	—	—	Indoor unit	Indoor/outdoor communication circuit error (Detected at indoor side)	Corresponding unit only stops.	Indoor unit does not receive communication from outdoor unit.	<ul style="list-style-type: none"> Check power-ON order of indoor/outdoor. Check indoor address setup. Check inter-unit cabling between indoor and outdoor. Check outdoor end terminal resistance setup (SW30-2).
E06	E06	No. of indoor units which received signal normally	I/F	Decreased number of indoor units	All stop	When signal is not sent for a certain period from the indoor unit which has been used to send signals.	<ul style="list-style-type: none"> Check the power supply of indoor unit. (Power-ON) Check connection of communication line between indoor and outdoor. Check connector connection for communication in indoor P.C. board. Check connector connection for communication in outdoor P.C. board. Check indoor P.C. board failure. Check outdoor P.C. board (I/F) failure.
—	E07	—	I/F	Indoor/outdoor communication circuit error (Detected at outdoor side)	All stop	Transmission from outdoor to indoor cannot continue for 30 seconds.	<ul style="list-style-type: none"> Check outdoor terminator resistor setup (SW30-2). Check the communication connection between indoor and outdoor.
E08	E08	Duplicated indoor addresses	Indoor I/F	Duplicated indoor addresses	All stop	Multiple indoor unit address setup are duplicated.	<ul style="list-style-type: none"> Check indoor address. Check the change of remote controller connection (Group / individual) after setup of indoor address.
E09	—	—	Remote controller	Duplicated master remote controllers	Corresponding unit only stops.	In 2-remote controller control (including wireless), both are setup as master (Header indoor unit stops and other indoor unit is operating.)	<ul style="list-style-type: none"> Check remote controller setup. Check remote controller P.C. board.
E10	—	—	Indoor unit	Communication error between indoor P.C. board assembly	Corresponding unit only stops.	Communication was not succeeded after power was supplied or during communication.	<ul style="list-style-type: none"> Indoor P.C. board failure
E12	E12	01: Indoor/outdoor communication 02: Between outdoors communication	I/F	Automatic address start error	All stop	<ul style="list-style-type: none"> When indoor automatic address started, other refrigerant circuit system was setting automatic address. When outdoor automatic address started, indoor automatic address was executed. 	<ul style="list-style-type: none"> Setup the address again after disconnecting communication with other refrigerant circuit system.

Wired remote controller	Check code		Detected position	Check code name	Status	Error detection condition	Check item (position)
	Check code	Outdoor 7-segment display Auxiliary code					
E15	E15	—	I/F	No corresponding indoor unit during automatic address	All stop	Indoor unit is not found when indoor automatic address start was set up.	<ul style="list-style-type: none"> Check the communication line connection between indoor and outdoor. Check the electric power line error in indoor. Check the noise of surrounding devices. Power failure Check indoor P.C. board error.
E16	E16	00: Capacity over 01 to: No. of connected units	I/F	No. of connected indoor units / Capacity over	All stop	<ul style="list-style-type: none"> Total capacity of indoor units exceeded 135% of total outdoor capacity. No. of connected indoor units are more than 48 units. <p>[Note] If this code appears after backup setup of outdoor unit trouble, set up "No. capacity-over detection".</p> <p><Setup method of "No. capacity-over detection"> Turn on SW09/Bit 2 on I/F P.C. board of outdoor header unit.</p>	<ul style="list-style-type: none"> Check the connection capacity of indoor unit. Check the HP capacity of indoor unit. Check the indoor/outdoor capacity setup Check the No. of connected indoor units. Check the outdoor I/F P.C. board error
E18	—	—	Indoor unit	Communication error between indoor header and follower units	Corresponding unit only stops.	Regular communication between indoor header and follower units	<ul style="list-style-type: none"> Check cable of the remote controller. Check power cabling of indoor. Check P.C. board of indoor.
E19	E19	00: No header unit 02: Two or more header units	I/F	Header outdoor unit quantity error	All stop	<ul style="list-style-type: none"> There are multiple header outdoor units in 1 line. There is none of header outdoor unit in 1 line. 	<ul style="list-style-type: none"> The outdoor unit connected with communication cable between indoor and outdoor (U1, U2) is the outdoor unit. Check connection of communication line between indoor and outdoor. Check outdoor P.C. board (I/F) error.
E20	E20	01: Connection of outdoor of other line 02: Connection of indoor of other line	I/F	Other line unit connected during automatic address	All stop	Unit of other line was connected when indoor automatic address started.	Separate the cable between lines according to automatic address setup method in "Address setup".
E23	E23	—	I/F	Communication sending error between outdoor units	All stop	Transmission of other outdoor unit was unavailable for 30 seconds or more.	<ul style="list-style-type: none"> Check power supply in outdoor unit. (Is power supplied?) Check connection or disconnection of connecting wire between outdoor units. Check connection of connector for outdoor P.C. board communication. Check outdoor P.C. board (I/F) error. Check terminal resistance setting of communication between outdoor units
E25	E25	—	I/F	Duplicated outdoor follower address setup	All stop	Outdoor addresses manually set up are duplicated.	<p>[Note] Do not set up the outdoor address manually.</p>
E26	E26	No. of normally received outdoor units	I/F	Decreased number of connected outdoor units	All stop	The signal was not returned for constant from the outdoor unit which was receiving signal.	<ul style="list-style-type: none"> Outdoor backup is being set. Check power supply of outdoor unit. (Is power supplied?) Check connection or disconnection of connecting wire between outdoor units. Check connection of connector for outdoor P.C. board communication. Check outdoor P.C. board (I/F) error.
E28	E28	No. of detected outdoor units	I/F	Outdoor follower unit error	All stop	Outdoor header unit received error code from outdoor follower unit.	<ul style="list-style-type: none"> Check the check code of outdoor follower unit.

<Convenient functions>

When pushing SW04 for 1 second or more under condition that [E28] is displayed on 7-segment display of outdoor header unit, the fan of outdoor unit which stopped abnormally starts rotating.
If pushing SW04 and SW05 simultaneously, the fan of normal outdoor unit operates. When pushing SW05 singly, the operation of fan is cleared.

Wired remote controller	Check code			Detected position	Check code name	Status	Error detection condition	Check item (position)																																																																																																																																																																																																					
	Check code	Outdoor 7-segment display																																																																																																																																																																																																											
		Auxiliary code																																																																																																																																																																																																											
E31	E31	<table border="1"> <thead> <tr> <th colspan="3">A-3-IPDU</th> <th colspan="3">FAN</th> <th colspan="3">IPDU</th> <th colspan="3">A-3-IPDU</th> <th colspan="3">FAN</th> <th colspan="3">IPDU</th> </tr> <tr> <th>1</th><th>2</th><th>3</th> <th>1</th><th>2</th><th>3</th> <th>1</th><th>2</th><th>3</th> <th>1</th><th>2</th><th>3</th> <th>1</th><th>2</th><th>3</th> <th>1</th><th>2</th><th>3</th> </tr> </thead> <tbody> <tr> <td>01</td><td>O</td><td></td> <td></td><td></td><td></td> <td>0A</td><td></td><td></td> <td></td><td></td><td></td> <td></td><td></td><td></td> <td></td><td></td><td></td> </tr> <tr> <td>02</td><td></td><td></td> <td></td><td></td><td></td> <td>0B</td><td>O</td><td></td> <td></td><td></td><td></td> <td></td><td></td><td></td> <td></td><td></td><td></td> </tr> <tr> <td>03</td><td>O</td><td></td> <td></td><td></td><td></td> <td>0C</td><td></td><td></td> <td></td><td></td><td></td> <td></td><td></td><td></td> <td></td><td></td><td></td> </tr> <tr> <td>04</td><td></td><td></td> <td></td><td></td><td></td> <td>0D</td><td></td><td></td> <td></td><td></td><td></td> <td></td><td></td><td></td> <td></td><td></td><td></td> </tr> <tr> <td>05</td><td>O</td><td></td> <td></td><td></td><td></td> <td>0E</td><td>O</td><td></td> <td></td><td></td><td></td> <td></td><td></td><td></td> <td></td><td></td><td></td> </tr> <tr> <td>06</td><td></td><td></td> <td></td><td></td><td></td> <td>0F</td><td>O</td><td></td> <td></td><td></td><td></td> <td></td><td></td><td></td> <td></td><td></td><td></td> </tr> <tr> <td>07</td><td>O</td><td></td> <td></td><td></td><td></td> <td></td><td></td><td></td> <td></td><td></td><td></td> <td></td><td></td><td></td> <td></td><td></td><td></td> </tr> <tr> <td>08</td><td></td><td></td> <td></td><td></td><td></td> <td></td><td></td><td></td> <td></td><td></td><td></td> <td></td><td></td><td></td> <td></td><td></td><td></td> </tr> <tr> <td>09</td><td>O</td><td></td> <td></td><td></td><td></td> <td></td><td></td><td></td> <td></td><td></td><td></td> <td></td><td></td><td></td> <td></td><td></td><td></td> </tr> </tbody> </table> O mark: Error position.	A-3-IPDU			FAN			IPDU			A-3-IPDU			FAN			IPDU			1	2	3	1	2	3	1	2	3	1	2	3	1	2	3	1	2	3	01	O					0A												02						0B	O											03	O					0C												04						0D												05	O					0E	O											06						0F	O											07	O																	08																		09	O																	I/F	IPDU communication error	All stop	Communication of each IPDU (P.C. board) in inverter box interrupted.	<ul style="list-style-type: none"> Check connection of communication connector and disconnection between IPDU and I/F P.C. board. Check outdoor P.C. board (I/F Comp., IPDU, Fan IPDU) error. Check external noise.
A-3-IPDU			FAN			IPDU			A-3-IPDU			FAN			IPDU																																																																																																																																																																																														
1	2	3	1	2	3	1	2	3	1	2	3	1	2	3	1	2	3																																																																																																																																																																																												
01	O					0A																																																																																																																																																																																																							
02						0B	O																																																																																																																																																																																																						
03	O					0C																																																																																																																																																																																																							
04						0D																																																																																																																																																																																																							
05	O					0E	O																																																																																																																																																																																																						
06						0F	O																																																																																																																																																																																																						
07	O																																																																																																																																																																																																												
08																																																																																																																																																																																																													
09	O																																																																																																																																																																																																												
F01	—	—	Indoor unit	Indoor TCJ sensor error	Corresponding unit only stops.	Resistance value of sensor is infinite or zero. (Open/Short)	<ul style="list-style-type: none"> Check connection/cabling of TCJ sensor connector. Check characteristics of TCJ sensor resistance value. Check indoor P.C. board error. 																																																																																																																																																																																																						
F02	—	—	Indoor unit	Indoor TC2 sensor error	Corresponding unit only stops.	Resistance value of sensor is infinite or zero (Open/Short).	<ul style="list-style-type: none"> Check connection/cabling of TC2 sensor connector. Check characteristics of TC2 sensor resistance value. Check indoor P.C. board error. 																																																																																																																																																																																																						
F03	—	—	Indoor unit	Indoor TC1 sensor error	Corresponding unit only stops.	Resistance value of sensor is infinite or zero (Open/Short).	<ul style="list-style-type: none"> Check connection/cabling of TC1 sensor connector. Check characteristics of TC1 sensor resistance value. Check indoor P.C. board error. 																																																																																																																																																																																																						
F04	F04	—	I/F	TD1 sensor error	All stop	Resistance value of sensor is infinite or zero (Open/Short)	<ul style="list-style-type: none"> Check connection of TD1 sensor connector. Check characteristics of TD1 sensor resistance value. Check outdoor P.C. board (I/F) error. 																																																																																																																																																																																																						
F05	F05	—	I/F	TD2 sensor error	All stop	Resistance value of sensor is infinite or zero (Open/Short)	<ul style="list-style-type: none"> Check connection of TD2 sensor connector. Check characteristics of TD2 sensor resistance value. Check outdoor P.C. board (I/F) error. 																																																																																																																																																																																																						
F06	F06	01: TE1 sensor error 02: TE2 sensor error	I/F	TE1, TE2 sensor error	All stop	Resistance value of sensor is infinite or zero (Open/Short).	<ul style="list-style-type: none"> Check connection of TE1, TE2 sensor connector. Check characteristics of TE1, TE2 sensor resistance value. Check outdoor P.C. board (I/F) error. 																																																																																																																																																																																																						
F07	F07	—	I/F	TL sensor error	All stop	Resistance value of sensor is infinite or zero (Open/Short).	<ul style="list-style-type: none"> Check connection of TL sensor connector. Check characteristics of TL sensor resistance value. Check outdoor P.C. board (I/F) error. 																																																																																																																																																																																																						
F08	F08	—	I/F	TO sensor error	All stop	Resistance value of sensor is infinite or zero (Open/Short).	<ul style="list-style-type: none"> Check connection of TO sensor connector. Check characteristics of TO sensor resistance value. Check outdoor P.C. board (I/F) error. 																																																																																																																																																																																																						
F10	—	—	Indoor	Indoor TA sensor error	Corresponding unit only stops.	Resistance value of sensor is infinite or zero (Open/Short).	<ul style="list-style-type: none"> Check connection/cabling of TA sensor connector. Check characteristics of TA sensor resistance value. Check indoor P.C. board error. 																																																																																																																																																																																																						
F12	F12	—	I/F	TS1 sensor error	All stop	Resistance value of sensor is infinite or zero (Open/Short).	<ul style="list-style-type: none"> Check connection of TS1 sensor connector. Check characteristics of TS1 sensor resistance value. Check outdoor P.C. board (I/F) error. 																																																																																																																																																																																																						
F13	F13	01: Compressor 1 side 02: Compressor 2 side 03: Compressor 3 side	IPDU	TH sensor error	All stop	Resistance value of sensor is infinite or zero (Open/Short).	<ul style="list-style-type: none"> IGBT built-in temp sensor error → Exchange Comp. IPDU P.C. board. 																																																																																																																																																																																																						

Wired remote controller	Check code		Detected position	Check code name	Status	Error detection condition	Check item (position)
	Outdoor 7-segment display	Auxiliary code					
	Check code	Auxiliary code					
F15	F15	—	I/F	Outdoor temp sensor miscabling (TE1, TL)	All stop	During operation of compressor in HEAT mode, the TE1 detection temp was higher than that of TL by the specified value continued for 3 minutes or more.	<ul style="list-style-type: none"> Check installation of TE1 sensor and TL sensor. Check characteristics of TE1 and TL sensor resistance value. Check outdoor P.C. board (I/F) error.
F16	F16	—	I/F	Outdoor pressure sensor miscabling (Pd, Ps)	All stop	High-pressure Pd sensor and low-pressure Ps sensor were exchanged, or output voltages of both sensors are zero.	<ul style="list-style-type: none"> Check connection of high-pressure Pd sensor connector. Check connection of low-pressure Ps sensor connector. Check pressure sensors Pd and Ps error. Check outdoor P.C. board (I/F) error. Check compression error of compressor.
F22	F22	—	I/F	TD3 sensor error	All stop	Sensor resistance value is infinite or 0 (Open/Short)	<ul style="list-style-type: none"> Check connection of TD3 sensor connector. Check resistance value characteristics of TD3. Check error of outdoor P.C. board (I/F).
F23	F23	—	I/F	Ps sensor error	All stop	Output voltage of Ps sensor was zero.	<ul style="list-style-type: none"> Misconnection of Ps sensor and Pd sensor connectors Check connection of Ps sensor connector. Check Ps sensor error. Check compression error of compressor. Check 4-way valve error. Check outdoor P.C. board (I/F) error. Check SV4 circuit error.
F24	F24	—	I/F	Pd sensor error	All stop	Output voltage of Pd sensor was zero. (Sensor Open) Pd > 4.15MPa during stop of compressor	<ul style="list-style-type: none"> Check connection of Pd sensor connector. Check Pd sensor error. Check outdoor P.C. board (I/F) error.
F29	—	—	Indoor	Indoor other error	Corresponding unit only stops.	Indoor P.C. board did not operate normally.	<ul style="list-style-type: none"> Check indoor P.C. board error (EEPROM error).
F31	F31	—	I/F	Outdoor EEPROM error	All stop (*1)	Outdoor P.C. board (I/F) did not operate normally.	<ul style="list-style-type: none"> Check power voltage. Check power noise. Check outdoor P.C. board (I/F) error.
H01	H01	01: Compressor 1 side 02: Compressor 2 side 03: Compressor 3 side	IPDU	Compressor breakdown	All stop	Inverter current detection circuit detected over-current and stopped.	<ul style="list-style-type: none"> Check power voltage. (AC380-415V ± 10%). Check compressor error. Check cause of abnormal overload operation. Check outdoor P.C. board (Comp. IPDU) error.
H02	H02	01: Compressor 1 side 02: Compressor 2 side 03: Compressor 3 side	IPDU	Compressor error (lock)	All stop	Over-current was detected several seconds after header compressor had started.	<ul style="list-style-type: none"> Check compressor error. Check power voltage. (AC380-415V ± 10%). Check cable of compressor and phase-missing. Check connector/terminal connection on IPDU P.C. board. Check conduction of case heater. (Check activation error due to liquid stagnation in compressor.) Check outdoor P.C. board (Comp. IPDU) error.
H03	H03	01: Compressor 1 side 02: Compressor 2 side 03: Compressor 3 side	IPDU	Current detection circuit system error	All stop	While header compressor stopped, current flowed more than the specified current and was detected.	<ul style="list-style-type: none"> Check cabling of current detection circuit system. Check outdoor P.C. board (Comp. IPDU) error.

(*1) All stop only in case of the header unit. The follower unit continues operation.

Wired remote controller	Check code		Detected position	Check code name	Status	Error detection condition	Check item (position)
	Check code	Outdoor 7-segment display Auxiliary code					
H04	H04	—	I/F	Compressor 1 case thermo operation	All stop	Compressor 1 case thermostat performed protective operation.	<ul style="list-style-type: none"> • Check compressor 1 case thermo circuit. (Connector, cable, P.C. board) • Check full opening of service valve. (Gas and liquid side) • Check outdoor PMV clogging. (PMV1, 2) • Check SV41 circuit leakage. • Check miscabling/misinstallation of SV41 and SV42. • Check valve open status of indoor PMV. • Check 4-way valve error. • Check refrigerant shortage.
H05	H05	—	I/F	Outdoor unit discharge temp. sensor (TD1) miswiring	All stop	While compressor 1 is operating, the discharge temp. (TD1) does not rise up.	<ul style="list-style-type: none"> • Check mounting of TD1 sensor • Check connection and wiring of TD1 sensor connector. • Check characteristics of TD1 sensor resistance value. • Check outdoor unit P.C. board (I/F) error.
H06	H06	—	I/F	Low-pressure protective operation	All stop	Low-pressure Ps detected operation lower than 0.02MPa.	<ul style="list-style-type: none"> • Check full opening of service valve. (Discharge gas, suction gas and liquid side) • Check outdoor PMV clogging. (PMV1, 2) • Check SV2 circuit and SV4 circuit error. • Check low-pressure Ps sensor error. • Check indoor air filter clogging. • Check valve open of indoor PMV. • Check refrigerant pipe clogging. • Check outdoor fan operation. (All heating, mainly heating, part cooling operation) • Check refrigerant shortage.
H07	H07	—	I/F	Protection for oil level drop detection	All stop	The operating compressor detected oil shortage continuously for 2 hours.	<p><Check all the outdoor units in the corresponding line.></p> <ul style="list-style-type: none"> • Check full opening of service valve of balance pipe. • Check connection and installation of TK1, TK2, TK3, and TK4 sensors. • Check characteristics of TK1, TK2, TK3, and TK4 resistance values. • Check gas leak and oil leak in the same line. • Check refrigerant stagnation in compressor. • Check error of SV3A, SV3B, SV3C, SV3D, and SV3E valves. • Check clogging of oil separator oil return circuit. • Check clogging of oil-equation circuit.
H08	H08	01: TK1 sensor error 02: TK2 sensor error 03: TK3 sensor error 04: TK4 sensor error 05: TK5 sensor error	I/F	Oil level detective temp sensor error	All stop	Resistance value of sensor is infinite or zero. (Open/Short)	<ul style="list-style-type: none"> • Check connection of TK1 sensor connector. • Check characteristics of TK1 sensor resistance value. • Check outdoor P.C. board (I/F) error.
					All stop	Resistance value of sensor is infinite or zero. (Open/Short)	<ul style="list-style-type: none"> • Check connection of TK2 sensor connector. • Check characteristics of TK2 sensor resistance value. • Check outdoor P.C. board (I/F) error.
					All stop	Resistance value of sensor is infinite or zero. (Open/Short)	<ul style="list-style-type: none"> • Check connection of TK3 sensor connector. • Check characteristics of TK3 sensor resistance value. • Check outdoor P.C. board (I/F) error.
					All stop	Resistance value of sensor is infinite or zero. (Open/Short)	<ul style="list-style-type: none"> • Check connection of TK4 sensor connector. • Check characteristics of TK4 sensor resistance value. • Check outdoor P.C. board (I/F) error.
					All stop	Resistance value of sensor is infinite or zero. (Open/Short)	<ul style="list-style-type: none"> • Check connection of TK5 sensor connector. • Check characteristics of TK5 sensor resistance value. • Check outdoor P.C. board (I/F) error.

Wired remote controller	Check code		Detected position	Check code name	Status	Error detection condition	Check item (position)
	Check code	Auxiliary code					
	Outdoor 7-segment display						
H15	H15	—	I/F	Outdoor unit discharge temp. sensor (TD2) miswiring	All stop	While compressor 2 is operating, the discharge temp. (TD2) does not rise up.	<ul style="list-style-type: none"> • Check mounting of TD2 sensor. • Check connection and wiring of TD2 sensor connector. • Check characteristics of TD2 sensor resistance value. • Check outdoor unit P.C. board (I/F) error.
H16	H16	01: TK1 oil circuit system error 02: TK2 oil circuit system error 03: TK3 oil circuit system error 04: TK4 oil circuit system error 05: TK5 oil circuit system error	I/F	Oil level detective circuit system error	All stop	Temperature change of TK1 could not be detected though compressor 1 started the operation.	<ul style="list-style-type: none"> • Check TK1 sensor coming-off. • Check characteristics of TK1 sensor resistance value. • Check TK1, TK2, TK3, TK4 and TK5 misconnection. • Check operation error of SV3E, SV3F valve. • Check capillary clogging of oil-equalization circuit and operation error of stop valve. • Check refrigerant stagnation in compressor.
						Temperature change of TK2 could not be detected though compressor 2 started the operation.	<ul style="list-style-type: none"> • Check TK2 sensor coming-off. • Check characteristics of TK2 sensor resistance value. • Check TK1, TK2, TK3, TK4 and TK5 misconnection. • Check SV3E, SV3F valve operation. • Check capillary clogging of oil equalization circuit and check stop valve operation. • Check refrigerant stagnation in compressor shell.
						Temperature change of TK3 could not be detected though compressor started the operation.	<ul style="list-style-type: none"> • Check TK3 sensor coming-off. • Check characteristics of TK3 sensor resistance value. • Check TK1, TK2, TK3, TK4 and TK5 misconnection. • Check SV3E, SV3F valve operation. • Check capillary clogging of oil-equalization circuit and check valve operation. • Check refrigerant stagnation in compressor shell.
						Temperature change of TK4 could not be detected though compressor started the operation, or the difference from other TK sensor changed for a constant time only within the specified range.	<ul style="list-style-type: none"> • Check TK4 sensor coming-off. • Check characteristics of TK4 sensor resistance value. • Check TK1, TK2, TK3, TK4 and TK5 misconnection. • Check SV3E, SV3F valve operation. • Check capillary clogging of oil-equalization circuit and check valve operation. • Check refrigerant stagnation in compressor shell.
						Temperature change of TK5 could not be detected though compressor started the operation, or the difference from other TK sensor changed for a constant time only within the specified range.	<ul style="list-style-type: none"> • Check TK5 sensor coming-off. • Check characteristics of TK5 sensor resistance value. • Check TK1, TK2, TK3, TK4 and TK5 misconnection. • Check SV3E valve operation error. • Check capillary clogging of oil-equalization circuit and check valve operation error. • Check refrigerant stagnation in compressor.
H25	H25	—	I/F	Outdoor unit discharge temp. sensor (TD3) miswiring	All stop	While compressor 2 is operating, the discharge temp. (TD3) does not rise up.	<ul style="list-style-type: none"> • Check mounting of TD3 sensor. • Check connection and wiring of TD3 sensor connector. • Check characteristics of TD3 sensor resistance value. • Check outdoor unit P.C. board (I/F) error.
L03	—	—	Indoor	Duplicated indoor center units	Corresponding unit only stops.	There are multiple center units in a group.	<ul style="list-style-type: none"> • Check indoor address. • Check the change of remote controller connection (Group/individual) after indoor address setup.
L04	L04	—	I/F	Duplicated outdoor line address	All stop	Line address setup is duplicated against the outdoor unit in different refrigerant pipe system.	<ul style="list-style-type: none"> • Check line address.

Wired remote controller	Check code		Detected position	Check code name	Status	Error detection condition	Check item (position)
	Outdoor 7-segment display						
	Check code	Auxiliary code					
L05	—	—	I/F	Duplicated indoor units with priority (Displayed on indoor unit with priority)	All stop	Indoor units with priority were duplicated.	• Check display of indoor unit with priority.
L06	L06	No. of indoor units with priority	I/F	Duplicated indoor units with priority (Displayed on the unit other than indoor unit with priority)	All stop	Indoor units with priority were duplicated.	• Check display of indoor unit with priority and outdoor unit.
L07	—	—	Indoor	Group line in individual indoor unit.	Corresponding unit only stops.	At least one indoor unit connected to a group existed in the individual indoor units.	• Check indoor address.
L08	L08	—	Indoor	Indoor group / address unset	Corresponding unit only stops.	Address was not yet set up.	• Check indoor address. Note) After installation, this code is displayed when the power is firstly turned on.
L09	—	—	Indoor	Indoor capacity unset	Corresponding unit only stops.	Indoor unit capacity was unset.	Set up indoor capacity. (DN=11)
L10	L10	—	I/F	Outdoor capacity unset	All stop	On the I/F P.C. board for service, jumper line was not cut according to the model.	Check model setup on outdoor I/F P.C. board Assy for service.
L20	—	—	TCC-Link Indoor	Duplicated central control addresses	All stop	Duplicated central control addresses	• Check central control address. • Check network adaptor P.C. board. (In case of TCC-Link)
L28	L28	—	I/F	Quantity over of connected outdoor units	All stop	There were more than four outdoor units.	• Check No. of connected outdoor units. (Max. 4 units per 1 system) • Check communication line between outdoor units. • Check outdoor P.C. board (I/F) error.
L29	L29	—	I/F	IPDU quantity error	All stop	No. of IPDU units detected when power was turned on were less.	• Check model setup for outdoor I/F service P.C. board. • Check connection of UART communication connector. • Check Comp. IPDU, fan IPDU, and I/F P.C. board error. Note) UART: Universal Asynchronous Receiver Transmitter
L30	L30	Detected indoor address	Indoor	Interlock in indoor unit from outside	Corresponding unit only stops.	• Outside error input terminal Detected signal to (CN80) for more 1 minute	■ Outside device is connected to connector (CN80): 1) Check outside device error. 2) Check indoor P.C. board error. ■ Outside device is not connected to connector (CN80): 1) Check indoor P.C. board error.
—	L31	—	I/F	Extended IC (Integrated Circuit) error	Operation continues.	P.C. board (I/F) parts error	Check indoor (I/F) P.C. board.

A-3-IPDU		FAN IPDU		A-3-IPDU			FAN IPDU	
1	2	3	1	2	3	1	2	3
01	○	○	○	0A	○	○	○	○
02	○	○	○	0B	○	○	○	○
03	○	○	○	0C	○	○	○	○
04	○	○	○	0D	○	○	○	○
05	○	○	○	0E	○	○	○	○
06	○	○	○	0F	○	○	○	○
07	○	○	○					
08	○	○	○					
09	○	○	○					

○ mark: Error position.

Wired remote controller	Check code		Detected position	Check code name	Status	Error detection condition	Check item (position)
	Outdoor 7-segment display	Auxiliary code					
	Check code	Auxiliary code					
P01	—	—	Indoor	Indoor fan motor error	Corresponding unit only stops.		<ul style="list-style-type: none"> • Check the lock of fan motor (AC fan). • Check cabling.
P03	P03	—	I/F	Discharge temp TD1 error	All stop	Discharge temp (TD1) exceeded 115°C.	<ul style="list-style-type: none"> • Check full opening of outdoor service valves (Gas side, Liquid side). • Check clogging of outdoor PMV. (PMV1, 2, 4) • Check characteristics of TD1 sensor resistance value. • Check refrigerant shortage. • Check 4-way valve error. • Check leakage of SV4 circuit. • Check SV4 circuit. (Miswiring and misinstallation of SV41, SV42 and SV43)
P04	P04	01: Compressor 1 side 02: Compressor 2 side 03: Compressor 3 side	I/F	Actuation of high-pressure SW	All stop	High-pressure SW actuated.	<ul style="list-style-type: none"> • Check connection of high-pressure SW connector. • Check Pd pressure sensor error. • Check full opening of outdoor service valves (Gas side, Liquid side). • Check outdoor fan error. • Check outdoor fan motor error. • Check clogging of outdoor PMV. (PMV1, 2) • Check clogging of indoor/outdoor heat exchangers. • Check short-circuiting of outdoor suction/discharge air. • Check clogging of SV2 circuit. • Check outdoor P.C. board (I/F) error. • Check indoor fan system error. (Cause of air volume decrease) • Check opening of indoor PMV. • Check miswiring of communication line between indoor and outdoor. • Check operation error of check valve of discharge pipe. • Check SV4 valve circuit. • Check SV5 valve circuit. • Check refrigerant overcharge.
P05	P05	00: — 01: Compressor 1 02: Compressor 2 03: Compressor 3	I/F	Open phase shortage/phase sequence detection Inverter DC voltage (Vdc) error (Compressor)	All stop	<ul style="list-style-type: none"> • Open phase was detected when the power turned on. • Overvoltage/Volt shortage was detected in inverter DC voltage 	<ul style="list-style-type: none"> • Check outdoor P.C. board (I/F) error.
P07	P07	01: Compressor 1 side 02: Compressor 2 side 03: Compressor 3 side	IPDU I/F	Heat sink overheat error	All stop	IGBT built-in temp sensor (TH) was overheated.	<ul style="list-style-type: none"> • Check power voltage. • Check outdoor fan system error. • Check clogging of heat sink cooling duct. • Check fixation between IGBT and heat sink. (Check screwing and contact.) • Check IPDU error. (IGBT built-in temp sensor (TH) error).
P10	P10	Indoor address with trouble	Indoor	Indoor overflow error	All stop	<ul style="list-style-type: none"> • Float switch operated. • Float switch circuit disconnected or the connector came off. 	<ul style="list-style-type: none"> • Check the float switch connector. • Check operation of drain pump unit. • Check the drain pump circuit. • Check clogging of drain pipe. • Check indoor P.C. board error.
P12	—	—	Indoor	Indoor fan motor error	Corresponding unit only stops.	<ul style="list-style-type: none"> • The value of motor speed deviated from target value was detected for certain time. • Over-current protection operated. 	<ul style="list-style-type: none"> • Check connection of fan connector and wiring. • Check fan motor error. • Check indoor P.C. board error. • Check influence of outside air control.

Wired remote controller	Check code		Detected position	Check code name	Status	Error detection condition	Check item (position)
	Outdoor 7-segment display	Auxiliary code					
	Check code	Auxiliary code					
P13	P13	—	I/F	Outdoor liquid back detection error	All stop	<p><In cooling> While the system operated in cooling mode, high status of high pressure value was detected in the stopped follower unit.</p> <p><In heating> While the system is operating in HEAT mode, outdoor PMV of which opening degree was 100 pulse or less for a certain time.</p>	<ul style="list-style-type: none"> • Check full close operation of outdoor PMV (1, 2, 4). • Check Pd and Ps sensor error. • Check clogging of SV2 circuit. • Check clogging of balance pipe. • Check clogging of SV3B circuit. • Check outdoor P.C. board (I/F) error. • Check capillary clogging of oil return circuit from oil separator. • Check leakage of stop valve in discharge assembly part.
P15	P15	01: TS condition 02: TD condition	I/F	Gas leak detection (TS1 condition) Gas leak detection (TD condition)	All stop	<p>Protective stop which generates when the status that suction temperature is over the judgment standard temperature continued for 10 minutes was repeated for 4 times or more.</p> <p><TS error judgment standard temperature> In cooling operation: 60°C or higher In heating operation: 40°C or higher</p> <p>Protective stop which generates when the status that while compressor is under low frequency operation, the discharge temperature TD1, TD2 or TD3 detected 108°C or more continuously for 10 minutes was repeated for 4 times or more.</p>	<ul style="list-style-type: none"> • Check refrigerant shortage. • Check full open of outdoor service valves (gas side, liquid side). • Check outdoor PMV clogging (PMV1, 2). • Check characteristics of TS1 sensor resistance value. • Check 4-way valve error. • Check leakage of SV4 circuit.
P17	P17	—	I/F	Discharge temp TD2 error	All stop	Protective stop which generates when the discharge temperature (TD2) was over 115°C was repeated for 4 times or more.	<ul style="list-style-type: none"> • Check full opening of outdoor service valves (gas side, liquid side). • Check clogging of outdoor PMV (PMV1, 2, 4). • Check characteristics of TD2 sensor resistance value. • Check 4-way valve error. • Check leakage of SV4 circuit. • Check SV4 circuit. (Miscabling and misinstallation of SV41, SV42 and SV43)
P18	P18	—	I/F	Discharge temp. TD3 error	All stop	Discharge temp. (TD3) exceeded 115°C.	<ul style="list-style-type: none"> • Check full opening of outdoor service valve (gas side, liquid side). • Check clogging of outdoor PMV (PMV1, 2, 4) • Check characteristics of TD3 sensor resistance value. • Check 4-way valve error. • Check leakage of SV4 circuit. • Check SV4 circuit. (Miswiring and mismounting of SV41, SV42, and SV43).
P19	P19	Detected outdoor unit No.	I/F	4-way valve operation error	All stop	When abnormal refrigerating cycle data was detected in heating	<ul style="list-style-type: none"> • Error of 4-way valve error. • Check coil error and connector connection of 4-way valve. • Check characteristics of TS1/TE1 sensor resistance value. • Check characteristics of Pd, Ps pressure sensor output voltage. • Check misconnection of TE1 and TL sensors.
P20	P20	—	I/F	High-pressure protective operation	All stop	Pd sensor detected 3.6MPa or more.	<ul style="list-style-type: none"> • Check Pd pressure sensor error. • Check full opening of service valves (Gas side, Liquid side). • Check outdoor fan error. • Check outdoor fan motor error. • Check clogging of outdoor PMV. (PMV1, 2, 4) • Check clogging of indoor/outdoor heat exchangers. • Check air short-circuiting in outdoor unit. • Check clogging of SV2 circuit. • Check outdoor P.C. board (I/F) error. • Check indoor fan system error. (Cause of air volume decrease) • Check misabling of communication line between indoor and outdoor. • Check operation error of stop valve in discharge assembly part. • Check circuit of gas balance SV4 valve. • Check refrigerant overcharge.

Wired remote controller	Check code		Detected position	Check code name	Status	Error detection condition	Check item (position)
	Check code	Outdoor 7-segment display					
	Check code	Auxiliary code					
P22	P22	0 *: IGBT circuit error between each position 1 *: Output circuit error between each position 3 *: Motor lock error 4 *: Detection of motor current C *: TH sensor error D *: TH sensor error E *: inverter DC voltage error (Outdoor unit fan)	IPDU	Outdoor fan IPDU error	All stop	(Auxiliary code: 0B) Fan IPDU position detection circuit Position detection was not normally performed. (Auxiliary code: 0A) Fan IPDU over-current protective circuit When the fan started and while it is operating, the status that current flows over constant flow was detected	<ul style="list-style-type: none"> Fan motor check Connection check of connector for fan motor Error check of IPDU P.C. board for fan
		<p>Note</p> <p>In " * ", 0 to F is displayed, but ignore it.</p>			All stop	(Auxiliary code: 0E) Fan IPDU position detection circuit Position detection was not normally performed.	<ul style="list-style-type: none"> Fan motor check Connection check of connector for fan motor Error check of IPDU P.C. board for fan
					All stop	(Auxiliary code: 0F) Fan IPDU position detection circuit Position detection was not normally performed.	<ul style="list-style-type: none"> Fan motor check Connection check of connector for fan motor Error check of IPDU P.C. board for fan
					All stop	(Auxiliary code: 06) External cause such as blast Position detection was not normally performed. (Restart after 6 seconds)	<ul style="list-style-type: none"> Fan motor check Connection check of connector for fan motor
					All stop	(Auxiliary code: 04) External cause such as blast When difference between target rpm and real rpm is 25% or more (Restart after 6 seconds)	<ul style="list-style-type: none"> Fan motor check Connection check of connector for fan motor
					All stop	(Auxiliary code: 0D) Fan IPDU position detection circuit Position detection was not normally performed. (Windless status)	<ul style="list-style-type: none"> Fan motor check Connection check of connector for fan motor Error check of IPDU P.C. board for fan
					All stop	(Auxiliary code: 0C) External cause such as blast Position detection was not normally performed. (Windy status) (Restart after 6 seconds)	<ul style="list-style-type: none"> Fan motor check Connection check of connector for fan motor
P26	P26	01: Compressor 1 side 02: Compressor 2 side 03: Compressor 3 side	IPDU	G-Tr short-circuit protection error	All stop	Instantaneous over-current was detected when compressor started.	<ul style="list-style-type: none"> Check connector connection and wiring on Comp. IPDU P.C. board. Check compressor error and defect of compressor coil. Check outdoor P.C. board (Comp. IPDU) error.
P29	P29	01: Compressor 1 side 02: Compressor 2 side 03: Compressor 3 side	IPDU	Compressor position detection circuit error	All stop	Position was not normally detected.	<ul style="list-style-type: none"> Check connector connection and wiring. Check compressor error and defect of compressor coil. Check P.C. board (Comp. IPDU) error.
P31	—	—	Indoor	Other indoor error (Group follower unit error)	Corresponding unit only stops.	E07/L07/L03/L08 was detected when other indoor unit in the group was defective.	<ul style="list-style-type: none"> Check indoor P.C. board.

Error detected by TCC-LINK central control device

Display on central control device	Check code		Detected position	Check code name	Status	Error detection condition	Check item (position)
	Outdoor 7-segment display	Auxiliary code					
C05	—		TCC-LINK	TCC-LINK central control device transmission error	Operation continued.	Signal is not transmit from central control device.	<ul style="list-style-type: none"> • Check central control device error. • Check communication line error of central control device. • Check setup of terminator resistor.
C06	—			TCC-LINK central control device transmission error	Operation continued.	Signal is not received from central control device.	<ul style="list-style-type: none"> • Check central control device error. • Check communication line error of central control device. • Check setup of terminator resistor. • Check the power of connecting destination connected device. • Check PC-board error of the connected device.
C12	—		General-purpose equipment I/F	General-purpose controller control interface batched alarm	Operation continued.	Error was input in general-purpose equipment control interface.	<ul style="list-style-type: none"> • Check error input.
P30	Differs according to error contents of the with alarm (L20 is displayed.)		TCC-LINK	Follower unit error of group control	Operation continued.	An error occurred in follower unit of the group control. ([P30] is displayed only on the central remote controller.)	<ul style="list-style-type: none"> • Check the check code of the unit with alarm.
				Duplicated central control address	Operation continued.	Central control addresses were duplicated.	<ul style="list-style-type: none"> • Check the address setup.

8-5. Sensor Characteristics

Indoor Unit

■ Temperature sensor characteristics

Indoor TA sensor

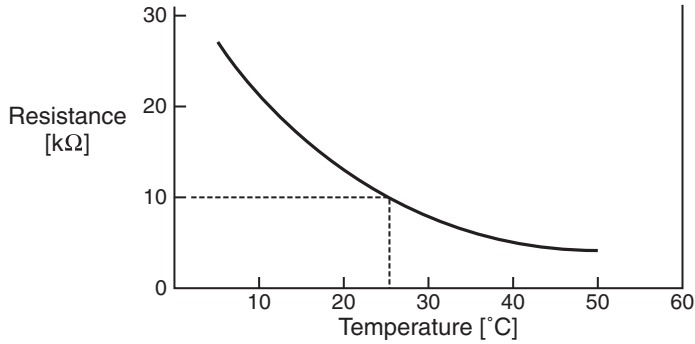

Temperature [°C]	Resistance value [kΩ]
0	33.9
5	26.1
10	20.3
15	15.9
20	12.6
25	10.0
30	8.0
35	6.4
40	5.2
45	4.2
50	3.5
55	2.8
60	2.4

Indoor TC1 sensor

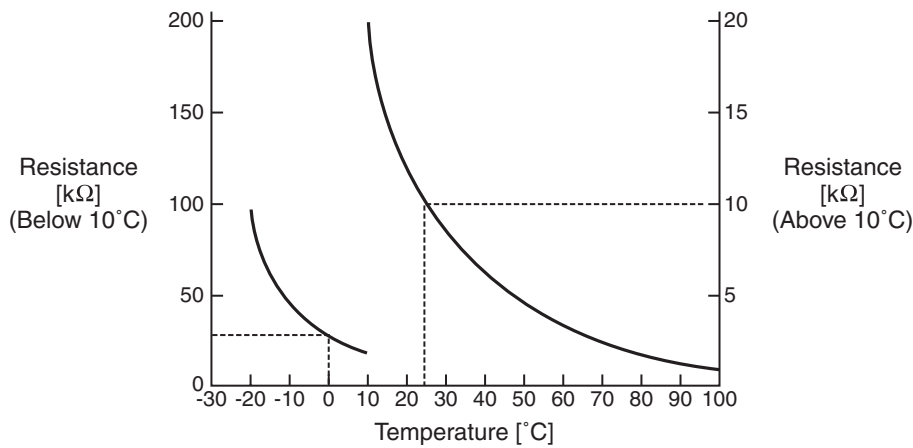

Temperature [°C]	Resistance value [kΩ]
-20	99.9
-15	74.1
-10	55.6
-5	42.2
0	32.8
5	25.4
10	19.8
15	15.6
20	12.4
25	10.0
30	8.1
35	6.5
40	5.3
45	4.4
50	3.6
55	3.0
60	2.5
65	2.1
70	1.8
75	1.5
80	1.3
85	1.1
90	1.0
95	0.8
100	0.7

Indoor TC2,TCJ sensor

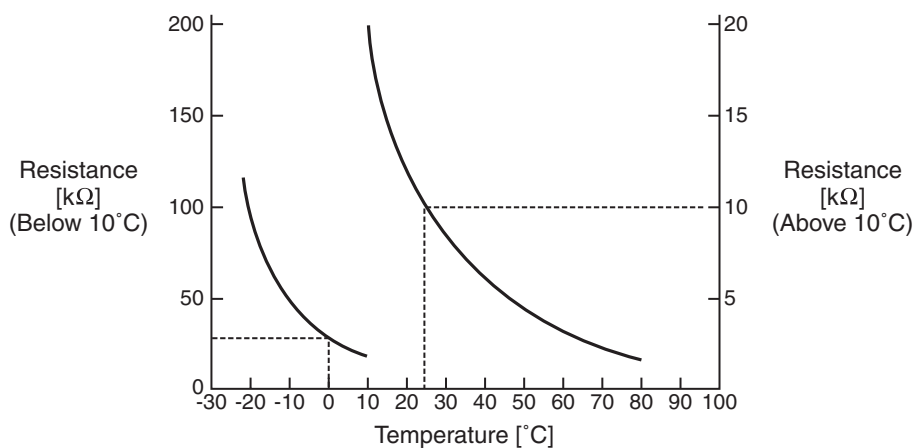

Temperature [°C]	Resistance value [kΩ]
-20	115.2
-15	84.2
-10	62.3
-5	46.6
0	35.2
5	26.9
10	20.7
15	16.1
20	12.6
25	10.0
30	8.0
35	6.4
40	5.2
45	4.2
50	3.5
55	2.8
60	2.4
65	2.0
70	1.6
75	1.4
80	1.2

9. INSTALLATION MANUAL

Please read this Installation Manual carefully before installing the Air Conditioner.

- This Manual describes the installation method of the indoor unit.
- For installation of the outdoor unit, follow the Installation Manual attached to the outdoor unit.

ADOPTION OF NEW REFRIGERANT

This Air Conditioner is a new type which adopts a new refrigerant HFC (R4-10A) instead of the conventional refrigerant R22 in order to prevent destruction of the ozone layer.

Contents

1	Precautions for Safety	5
2	Accessory Parts	9
3	Selection of Installation Place	10
4	Installation of Indoor Unit	13
5	Cutting a Hole and Mounting Installation Plate	14
6	Piping and Drain Hose Installation	15
7	Indoor Unit Fixing	18
8	Drainage	18
9	Refrigerant Piping	19
10	Electric Work	21
11	Applicable Controls	27
12	Test Run	30
13	Troubleshooting	32

Thank you for purchasing this Toshiba air conditioner.

Please read carefully through these instructions that contain important information which complies with the "Machinery" Directive (Directive 2006/42/EC), and ensure that you understand them.

After completing the installation work, hand over this Installation Manual as well as the Owner's Manual provided with the outdoor unit to the user, and ask the user to keep them in a safe place for future reference.

Generic Denomination: Air Conditioner

Definition of Qualified Installer or Qualified Service Person

The air conditioner must be installed, maintained, repaired and removed by a qualified installer or qualified service person. When any of these jobs is to be done, ask a qualified installer or qualified service person to do them for you.

A qualified installer or qualified service person is an agent who has the qualifications and knowledge described in the table below.



Agent	Qualifications and knowledge which the agent must have
Qualified installer	<ul style="list-style-type: none"> • The qualified installer is a person who installs, maintains, relocates and removes the air conditioners made by Toshiba Carrier Corporation. He or she has been trained to install, maintain, relocate and remove the air conditioners made by Toshiba Carrier Corporation or, alternatively, he or she has been instructed in such operations by an individual or individuals who have been trained and is thus thoroughly acquainted with the knowledge related to these operations. • The qualified installer who is allowed to do the electrical work involved in installation, relocation and removal has the qualifications pertaining to this electrical work as stipulated by the local laws and regulations, and he or she is a person who has been trained in matters relating to electrical work on the air conditioners made by Toshiba Carrier Corporation or, alternatively, he or she has been instructed in such matters by an individual or individuals who have been trained and is thus thoroughly acquainted with the knowledge related to this work. • The qualified installer who is allowed to do the refrigerant handling and piping work involved in installation, relocation and removal has the qualifications pertaining to this refrigerant handling and piping work as stipulated by the local laws and regulations, and he or she is a person who has been trained in matters relating to refrigerant handling and piping work on the air conditioners made by Toshiba Carrier Corporation or, alternatively, he or she has been instructed in such matters by an individual or individuals who have been trained and is thus thoroughly acquainted with the knowledge related to this work. • The qualified installer who is allowed to work at heights has been trained in matters relating to working at heights with the air conditioners made by Toshiba Carrier Corporation or, alternatively, he or she has been instructed in such matters by an individual or individuals who have been trained and is thus thoroughly acquainted with the knowledge related to this work.
Qualified service person	<ul style="list-style-type: none"> • The qualified service person is a person who installs, repairs, maintains, relocates and removes the air conditioners made by Toshiba Carrier Corporation. He or she has been trained to install, repair, maintain, relocate and remove the air conditioners made by Toshiba Carrier Corporation or, alternatively, he or she has been instructed in such operations by an individual or individuals who have been trained and is thus thoroughly acquainted with the knowledge related to these operations. • The qualified service person who is allowed to do the electrical work involved in installation, repair, relocation and removal has the qualifications pertaining to this electrical work as stipulated by the local laws and regulations, and he or she is a person who has been trained in matters relating to electrical work on the air conditioners made by Toshiba Carrier Corporation or, alternatively, he or she has been instructed in such matters by an individual or individuals who have been trained and is thus thoroughly acquainted with the knowledge related to this work. • The qualified service person who is allowed to do the refrigerant handling and piping work involved in installation, repair, relocation and removal has the qualifications pertaining to this refrigerant handling and piping work as stipulated by the local laws and regulations, and he or she is a person who has been trained in matters relating to refrigerant handling and piping work on the air conditioners made by Toshiba Carrier Corporation or, alternatively, he or she has been instructed in such matters by an individual or individuals who have been trained and is thus thoroughly acquainted with the knowledge related to this work. • The qualified service person who is allowed to work at heights has been trained in matters relating to working at heights with the air conditioners made by Toshiba Carrier Corporation or, alternatively, he or she has been instructed in such matters by an individual or individuals who have been trained and is thus thoroughly acquainted with the knowledge related to this work.

Definition of Protective Gear

When the air conditioner is to be transported, installed, maintained, repaired or removed, wear protective gloves and 'safety' work clothing. In addition to such normal protective gear, wear the protective gear described below when undertaking the special work detailed in the table below. Failure to wear the proper protective gear is dangerous because you will be more susceptible to injury, burns, electric shocks and other injuries.

Work undertaken	Protective gear worn
All types of work	Protective gloves 'Safety' working clothing
Electrical-related work	Gloves to provide protection for electricians and from heat Insulating shoes Clothing to provide protection from electric shock
Work done at heights (50 cm or more)	Helmets for use in industry
Transportation of heavy objects	Shoes with additional protective toe cap
Repair of outdoor unit	Gloves to provide protection for electricians and from heat

Warning indications on the air conditioner unit

Warning indication		Description
	<p>WARNING</p> <p>ELECTRICAL SHOCK HAZARD Disconnect all remote electric power supplies before servicing.</p>	<p>WARNING</p> <p>ELECTRICAL SHOCK HAZARD Disconnect all remote electric power supplies before servicing.</p>
	<p>WARNING</p> <p>Moving parts. Do not operate unit with grille removed. Stop the unit before the servicing.</p>	<p>WARNING</p> <p>Moving parts. Do not operate unit with grille removed. Stop the unit before the servicing.</p>
	<p>CAUTION</p> <p>High temperature parts. You might get burned when removing this panel.</p>	<p>CAUTION</p> <p>High temperature parts. You might get burned when removing this panel.</p>
	<p>CAUTION</p> <p>Do not touch the aluminum fins of the unit. Doing so may result in injury.</p>	<p>CAUTION</p> <p>Do not touch the aluminum fins of the unit. Doing so may result in injury.</p>
	<p>CAUTION</p> <p>BURST HAZARD Open the service valves before the operation, otherwise there might be the burst.</p>	<p>CAUTION</p> <p>BURST HAZARD Open the service valves before the operation, otherwise there might be the burst.</p>
	<p>CAUTION</p> <p>Open the service valves before the operation, otherwise there might be the burst.</p>	<p>CAUTION</p> <p>Open the service valves before the operation, otherwise there might be the burst.</p>

1. Precautions for Safety

The manufacturer shall not assume any liability for the damage caused by not observing the description of this manual.

WARNING

General

- Before starting to install the air conditioner, read through the Installation Manual carefully, and follow its instructions to install the air conditioner.
- Only a qualified installer or service person is allowed to do installation work. Inappropriate installation may result in water leakage, electric shock or fire.
- Do not use any refrigerant different from the one specified for complement or replacement. Otherwise, abnormally high pressure may be generated in the refrigeration cycle, which may result in a failure or explosion of the product or an injury to your body.
- Before opening the intake grille of the indoor unit or service panel of the outdoor unit, set the circuit breaker to the OFF position. Failure to set the circuit breaker to the OFF position may result in electric shocks through contact with the interior parts. Only a qualified installer(*) or qualified service person(*) is allowed to remove the intake grille of the indoor unit or service panel of the outdoor unit and do the work required.
- Before carrying out the installation, maintenance, repair or removal work, set the circuit breaker to the OFF position. Otherwise, electric shocks may result.
- Place a "Work in progress" sign near the circuit breaker while the installation, maintenance, repair or removal work is being carried out. There is a danger of electric shocks if the circuit breaker is set to ON by mistake.
- Only a qualified installer(*) or qualified service person(*) is allowed to undertake work at heights using a stand of 50 cm or more or to remove the intake grille of the indoor unit to undertake work.
- Wear protective gloves and safety work clothing during installation, servicing and removal.
- Do not touch the aluminium fin of the unit. You may injure yourself if you do so. If the fin must be touched for some reason, first put on protective gloves and safety work clothing, and then proceed.
- Do not climb onto or place objects on top of the outdoor unit. You may fall or the objects may fall off of the outdoor unit and result in injury.
- When work is performed at heights, use a ladder which complies with the ISO 14122 standard, and follow the procedure in the ladder's instructions. Also wear a helmet for use in industry as protective gear to undertake the work.
- Before cleaning the filter or other parts of the outdoor unit, set the circuit breaker to OFF without fail, and place a "Work in progress" sign near the circuit breaker before proceeding with the work.
- Before working at heights, put a sign in place so that no-one will approach the work location, before proceeding with the work. Parts and other objects may fall from above, possibly injuring a person below. While carrying out the work, wear a helmet for protection from falling objects.
- The refrigerant used by this air conditioner is the R410A.
- The air conditioner must be transported in stable condition. If any part of the product is broken, contact the dealer.
- When the air conditioner must be transported by hand, carry it by two or more people.
- Do not move or repair any unit by yourself. There is high voltage inside the unit. You may get electric shock when removing the cover and main unit.

Selection of installation location

- When the air conditioner is installed in a small room, provide appropriate measures to ensure that the concentration of refrigerant leakage occur in the room does not exceed the critical level.
- Do not install in a location where flammable gas leaks are possible. If the gas leak and accumulate around the unit, it may ignite and cause a fire.
- To transport the air conditioner, wear shoes with additional protective toe caps.
- To transport the air conditioner, do not take hold of the bands around the packing carton. You may injure yourself if the bands should break.
- Install the indoor unit at least 2.5 m above the floor level since otherwise the users may injure themselves or receive electric shocks if they poke their fingers or other objects into the indoor unit while the air conditioner is running.
- Do not place any combustion appliance in a place where it is directly exposed to the wind of air conditioner, otherwise it may cause imperfect combustion.

Installation

- When the indoor unit is to be suspended, the designated hanging bolts (M10 or W3/8) and nuts (M10 or W3/8) must be used.
- Install the air conditioner securely in a location where the base can sustain the weight adequately. If the strength is not enough, the unit may fall down resulting in injury.
- Follow the instructions in the Installation Manual to install the air conditioner. Failure to follow these instructions may cause the product to fall down or topple over or give rise to noise, vibration, water leakage or other trouble.
- Carry out the specified installation work to guard against the possibility of high winds and earthquake.
- If the air conditioner is not installed appropriately, a unit may topple over or fall down, causing an accident.
- If refrigerant gas has leaked during the installation work, ventilate the room immediately. If the leaked refrigerant gas comes in contact with fire, noxious gas may generate.
- Use forklift to carry in the air conditioner units and use winch or hoist at installation of them.

Refrigerant piping

- Install the refrigerant pipe securely during the installation work before operating the air conditioner. If the compressor is operated with the valve open and without refrigerant pipe, the compressor sucks air and the refrigeration cycles is over pressurized, which may cause a injury.
- Tighten the flare nut with a torque wrench in the specified manner. Excessive tighten of the flare nut may cause a crack in the flare nut after a long period, which may result in refrigerant leakage.
- After the installation work, confirm that refrigerant gas does not leak. If refrigerant gas leaks into the room and flows near a fire source, such as a cooking range, noxious gas may be generated.
- When the air conditioner has been installed or relocated, follow the instructions in the Installation Manual and purge the air completely so that no gases other than the refrigerant will be mixed in the refrigerating cycle. Failure to purge the air completely may cause the air conditioner to malfunction.
- Nitrogen gas must be used for the airtight test.
- The charge hose must be connected in such a way that it is not slack.

Electrical wiring

- Only a qualified installer^(*) or qualified service person^(*) is allowed to carry out the electrical work of the air conditioner. Under no circumstances must this work be done by an unqualified individual since failure to carry out the work properly may result in electric shocks and / or electrical leaks.
- To connect the electrical wires, repair the electrical parts or undertake other electrical jobs, wear gloves to provide protection for electricians and from heat, insulating shoes and clothing to provide protection from electric shocks. Failure to wear this protective gear may result in electric shocks.
- Use wiring that meets the specifications in the Installation Manual and the stipulations in the local regulations and laws. Use of wiring which does not meet the specifications may give rise to electric shocks, electrical leakage, smoking and / or a fire.
- Connect earth wire. (Grounding work)
- Incomplete grounding causes an electric shock.
- Do not connect earth wires to gas pipes, water pipes, and lightning conductor or telephone earth wires.
- After completing the repair or relocation work, check that the earth wires are connected properly.
- Install a circuit breaker that meets the specifications in the installation manual and the stipulations in the local regulations and laws.
- Install the circuit breaker where it can be easily accessed by the agent.
- When installing the circuit breaker outdoors, install one which is designed to be used outdoors.
- Under no circumstances the power wire must not be extended. Connection trouble in the places where the wire is extended may give rise to smoking and / or a fire.
- Electrical wiring work shall be conducted according to law and regulation in the community and installation manual.

Failure to do so may result in electrocution or short circuit.

Test run

- Before operating the air conditioner after having completed the work, check that the electrical parts box cover of the indoor unit and service panel of the outdoor unit are closed, and set the circuit breaker to the ON position. You may receive an electric shock if the power is turned on without first conducting these checks.
- If there is any kind of trouble (such as an error display has appeared, smell of burning, abnormal sounds, the air conditioner fails to cool or heat or water is leaking) has occurred in the air conditioner, do not touch the air conditioner yourself but set the circuit breaker to the OFF position, and contact a qualified service person. Take steps to ensure that the power will not be turned on (by marking "out of service" near the circuit breaker, for instance) until qualified service person arrives. Continuing to use the air conditioner in the trouble status may cause mechanical problems to escalate or result in electric shocks or other trouble.
- After the work has finished, use an insulation tester set (500 V Megger) to check the resistance is 1 MΩ or more between the charge section and the non-charge metal section (Earth section). If the resistance value is low, a disaster such as a leak or electric shock is caused at user's side.
- Upon completion of the installation work, check for refrigerant leaks and check the insulation resistance and water drainage. Then conduct a test run to check that the air conditioner is operating properly.

Explanations given to user

- Upon completion of the installation work, tell the user where the circuit breaker is located. If the user does not know where the circuit breaker is, he or she will not be able to turn it off in the event that trouble has occurred in the air conditioner.
- If the fan grille is damaged, do not approach the outdoor unit but set the circuit breaker to the OFF position, and contact a qualified service person^(*) to have the repairs done. Do not set the circuit breaker to the ON position until the repairs are completed.
- After the installation work, follow the Owner's Manual to explain to the customer how to use and maintain the unit.

Relocation

- Only a qualified installer^(*) or qualified service person^(*) is allowed to relocate the air conditioner. It is dangerous for the air conditioner to be relocated by an unqualified individual since a fire, electric shocks, injury, water leakage, noise and / or vibration may result.
- When carrying out the pump-down work shut down the compressor before disconnecting the refrigerant pipe. Disconnecting the refrigerant pipe with the service valve left open and the compressor still operating will cause air or other gas to be sucked in, raising the pressure inside the refrigeration cycle to an abnormally high level, and possibly resulting in rupture, injury or other trouble.



CAUTION

New Refrigerant Air Conditioner Installation

- **THIS AIR CONDITIONER ADOPTS THE NEW HFC REFRIGERANT (R410A) WHICH DOES NOT DESTROY OZONE LAYER.**
- The characteristics of R410A refrigerant are: easy to absorb water, oxidizing membrane or oil, and its pressure is approx. 1.6 times higher than that of refrigerant R22. Accompanied with the new refrigerant, refrigerating oil has also been changed. Therefore, do not let water, dust, former refrigerant, or refrigerating oil enter the refrigerating cycle during installation work.
- To prevent charging an incorrect refrigerant and refrigerating oil, the sizes of connecting sections of charging port of the main unit and installation tools are changed from those for the conventional refrigerant.
- Accordingly, the exclusive tools are required for the new refrigerant (R410A).
- For connecting pipes, use new and clean piping designed for R410A, and please care so that water or dust does not enter.

To Disconnect the Appliance from Main Power Supply.







- This appliance must be connected to the main power supply by means of a switch with a contact separation of at least 3 mm.

The installation fuse (all types can be used) must be used for the power supply line of this conditioner.

^(*) Refer to the "Definition of Qualified Installer or Qualified Service Person."

2. Accessory Parts

■ Accessory parts

Part name	Qty	Shape
Installation plate	1	
Wireless remote controller	1	
Battery	2	
Remote control holder	1	
Mounting screw $\varnothing 4 \times 25 \text{ l}$	6	
Pan head wood screw $\varnothing 3.1 \times 16 \text{ l}$	2	

<Others>

Name
Owner's manual
Installation manual
Paper pattern

3. Selection of Installation Place

⚠ WARNING

- Install the air conditioner at enough strong place to withstand the weight of the unit. If the strength is not enough, the unit may fall down resulting in injury.

⚠ CAUTION

- Do not install the air conditioner in a location subject to a risk of exposure to a combustible gas. If a combustible gas leaks and stays around the unit, a fire may occur.

Upon approval of the customer, install the air conditioner in a place that satisfies the following conditions.

- Place where the unit can be installed horizontally.
- Place where a sufficient servicing space can be ensured for safety maintenance and check.
- Place where drained water will not cause any problem.

Avoid installing in the following places.

- Place exposed to air with high salt content (seaside area), or place exposed to large quantities of sulfide gas (hot spring).
(Should the unit be used in these places, special protective measures are needed.)
- A restaurant kitchen where a lot of oil is used or place near machines in a factory (Oil adhering to the heat exchanger and resin part (cross flow fan) in the indoor unit may reduce the performance, generate mist or dew drop, or deform or damage resin parts.)
- Place where organic solvent is used nearby.
- Place close to a machine generating high frequency.
- Place where the discharged air blows directly into the window of the neighbour house. (Outdoor unit)
- Place where noise of the outdoor unit is easily transmitted.
(When install the outdoor unit on the boundary with the neighbour, pay due attention to the level of noise.)
- Place with poor ventilation.
- Do not use the air conditioner for special purposes such as preserving food, precision instruments, or art objects, or where breeding animals or growing plants are kept. (This may degrade the quality of preserved materials.)
- Place where any of high-frequency appliances (including inverter devices, private power generators, medical equipment, and communication equipment) and inverter-type fluorescent light is installed.
(A malfunction of the air conditioner, abnormal control, or problems due to noise to such appliances / equipment may occur.)
- When the wireless remote controller is used in a room equipped with an inverter-type fluorescent light or at a place exposed to direct sunlight, signals from the remote controller may not be received correctly.
- Place where organic solvent is used.
- Place near a door or window exposed to humid outside air (Dew dropping may form.).
- Place where special spray is used frequently.

■ Installation diagram of indoor and outdoor units

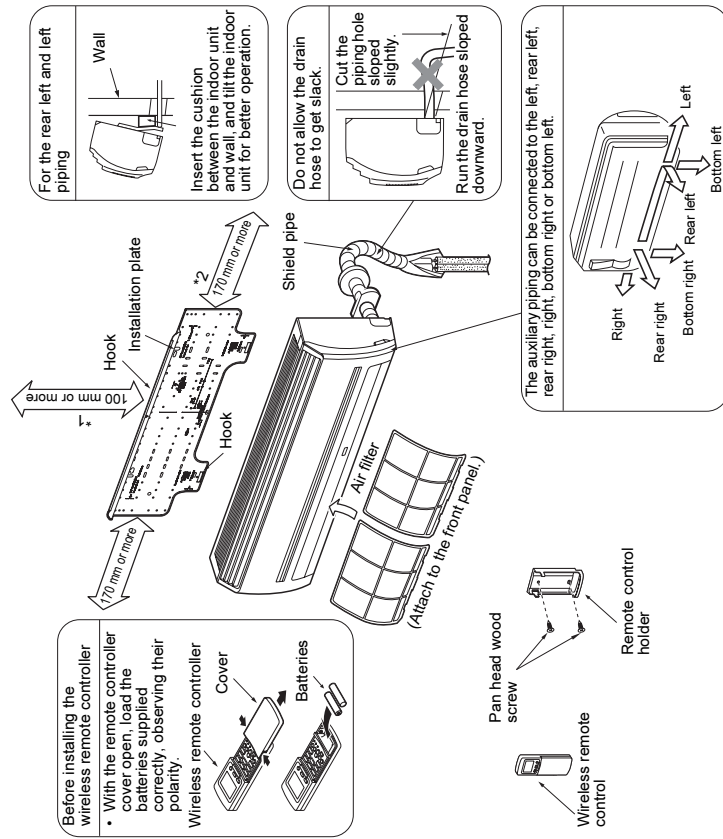

■ Installation space

The indoor unit shall be installed so that its top surface comes at a height of 2 m or more. Also it must be avoided to put anything on top of the indoor unit.

*1 Reserve space required to install the indoor unit and for service work.
 *2 Keep a space more than 300 mm for wiring work at installation of the Flow Selector Unit (FS Unit).

■ Installation place

- A place which provides the spaces around the indoor unit as shown in the above diagram.
- A place where there is no obstacle near the air intake and discharge.
- A place that allows easy installation of the piping to the outdoor unit.
- A place which allows the front panel to be opened.

⚠ CAUTION

- Direct sunlight to the indoor unit's wireless receiver should be avoided.
- The microprocessor in the indoor unit should not be too close to RF noise sources. (For details, see the owner's manual.)

■ Wireless remote controller

- A place where there are no obstacles such as a curtain that may block the signal from the indoor unit.
- Do not install the remote controller in a place exposed to direct sunlight or close to a heating source, such as a stove.
- Keep the remote controller at least 1 m apart from the nearest TV set or stereo equipment. (This is necessary to prevent image disturb-bounces or noise interference.)
- The location of the remote controller should be determined as shown below.

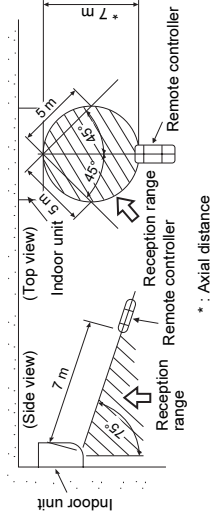

4. Installation of Indoor Unit

⚠ WARNING

Install the air conditioner certainly to sufficiently withstand the weight. If the strength is insufficient, the unit may fall down resulting in human injury. Perform a specified installation work to guard against strong wind or earthquake. An incomplete installation can cause accidents by the units falling and dropping.

REQUIREMENT

- Strictly comply with the following rules to prevent damage of the indoor units and human injury.
- Do not put a heavy article on the indoor unit. (Even units are packaged)
 - Carry in the indoor unit as it is packaged if possible. If carrying in the indoor unit unpacked by necessity, use buffering cloth or other material to not damage the unit.
 - To move the indoor unit, do not apply force to the refrigerant pipe, drain pan, foamed parts, or resin parts or other parts.
 - Carry the package by two or more persons, and do not bundle it with plastic band at positions other than specified.

Be careful to the following items at installation of the unit.

- Considering air discharge direction, select an installation place where discharge air can circulate evenly in a room. Avoid to install the unit at place with "NO GOOD" mark in the right figure.

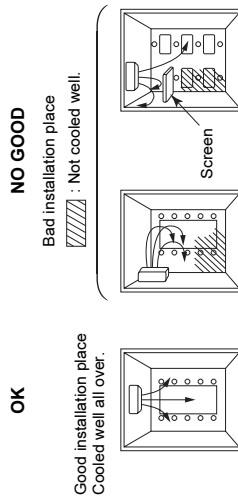

5. Cutting a Hole and Mounting Installation Plate

■ Cutting a hole

In case of installing the refrigerant pipes from the rear:

- 1 Decide the hole position for piping at 100 mm from the arrow mark (→) on the installation plate and drill a hole with $\varnothing 65$ mm at a slight downward slant toward outdoor side.

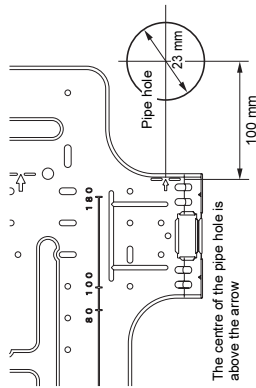

The centre of the pipe hole is above the arrow

NOTE

- To drill a wall that contains a metal lath, wire lath or metal plate, use a pipe hole brrim ring sold separately.

■ Mounting the installation plate

For installation of the indoor unit, use the paper pattern in the accessory parts.

Fix the installation plate to the wall with screws to make the indoor unit fit to the wall.

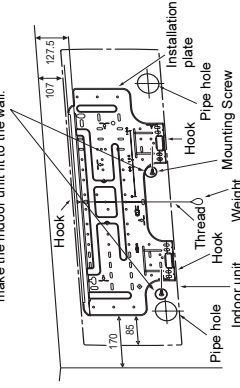

■ When the installation plate is directly mounted on the wall

- 1 Securely fit the installation plate onto the wall by screwing it in the upper and lower parts to hook up the indoor unit.
- 2 To mount the installation plate on a concrete wall with anchor bolts, utilize the anchor bolt holes as illustrated in the above figure.
- 3 Install the installation plate horizontally in the wall.

⚠ CAUTION

To install the installation plate with a mounting screw, do not use the anchor bolt hole. Otherwise the unit may fall down and result in personal injury and property damage.

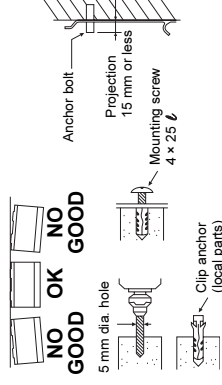

⚠ CAUTION

Failure to firmly install the unit may result in personal injury and property damage if the unit falls.

- In case of block, brick, concrete or similar type walls, make 5 mm dia. holes in the wall.
- Insert clip anchors for appropriate mounting screws.

NOTE

- Secure four corners and lower parts of the installation plate with 6 mounting screws to install it.

6. Piping and Drain Hose Installation

■ Piping and drain hose forming

* Apply heat-insulation for both refrigerant pipe and drain hose surely so that no dew generates inside of the equipment.
(Use polyethylene foam for insulating material.)

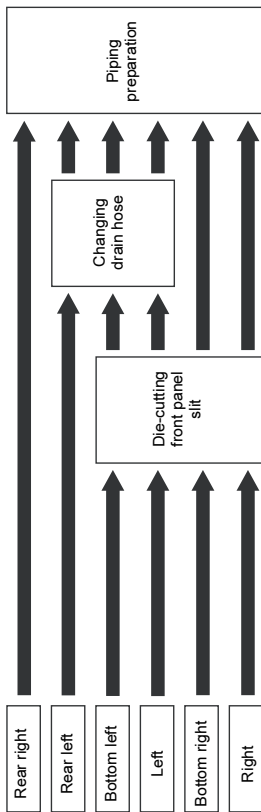

1. Die-cutting front panel slit

Cut out the slit on the leftward or right side of the front panel for the left or right connection and the slit on the bottom left or right side of the front panel for the bottom left or right connection with a pair of nippers.

2. Changing drain hose

For leftward connection, bottom-leftward connection and rear leftward connection's piping, it is necessary to change the drain hose and drain cap.

Without changing the drain hose position, the indoor unit will not fit to the wall.

How to remove the drain hose

- The drain hose can be removed by pulling out the drain hose.
- To remove the drain hose, be careful of any sharp edges of steel plate. The edges can injure.
- To install the drain hose, insert the drain hose firmly until the connection part contacts with heat insulator.

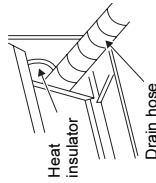

How to remove the drains cap

Clip the drain cap by needle-nose pliers and pull out.

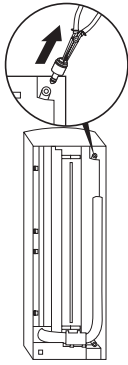

How to fix the drains cap

1) Insert hexagonal wrench (dia. 4 mm) in a centre head.

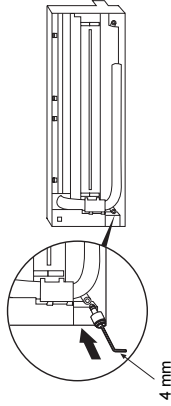

2) Firmly insert drains cap.

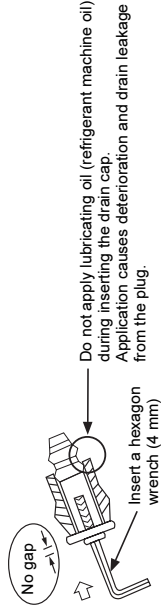

⚠ CAUTION

Firmly insert the drain hose and drain cap; otherwise, water may leak.

▼ In case of right or left piping

- After scribing slits of the front panel with a knife or a marking-off pin, cut them with a pair of nippers or an equivalent tool.

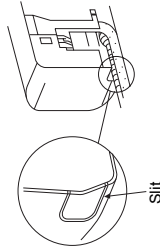

▼ In case of bottom right or bottom left piping

- After scribing slits of the front panel with a knife or a marking-off pin, cut them with a pair of nippers or an equivalent tool.

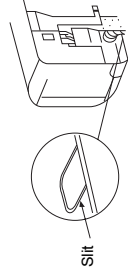

▼ **Left-hand connection with piping**

Bend the connecting pipe so that it is laid within 43 mm above the wall surface. If the connecting pipe is laid exceeding 43 mm above the wall surface, the indoor unit may unstably be set on the wall. To bending the connecting pipe, use a spring bender so as not to crush the pipe.

Bend the connection pipe within a radius of 30 mm.
To connect the pipe after installation of the unit (figure.)

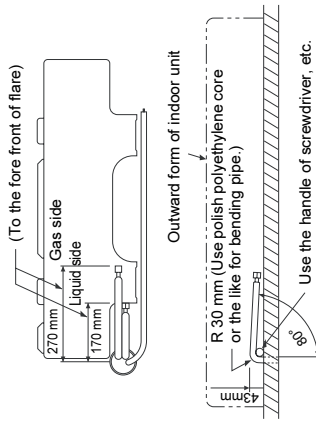

NOTE

If the pipe is bent incorrectly, the indoor unit may unstably be set on the wall. After passing the connecting pipe through the pipe hole, connect the connecting pipe to the auxiliary pipes and wrap the facing tape around them.

CAUTION

Bind the auxiliary pipes (two) and power supply wiring and control wiring with facing tape tightly. In case of leftward piping and rear leftward piping, bind the auxiliary pipes (two) only with facing tape.

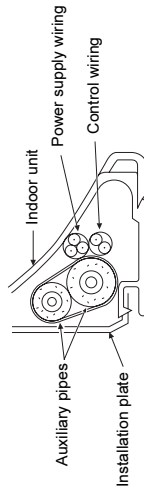

- Carefully arrange pipes so that any pipe does not stick out of the rear plate of the indoor unit.
- Carefully connect the auxiliary pipes and connecting pipes to one another and cut off the insulating tape wound on the connecting pipe to avoid double-taping at the joint, moreover, seal the joint with the vinyl tape.
- Since dew results in a machine trouble, insulate both the connecting pipes. (Use polyethylene foam as insulating material.)
- Bend a pipe carefully. Do not crush it.

7. Indoor Unit Fixing

- Pass the pipe through the hole in the wall, and hook the indoor unit on the installation plate at the upper hooks.
- Swing the indoor unit to right and left to confirm that it is firmly hooked up on the installation plate.
- While pressing the indoor unit onto the wall, hook it at the lower part on the installation plate. Pull the indoor unit toward you to confirm that it is firmly hooked up on the installation plate.

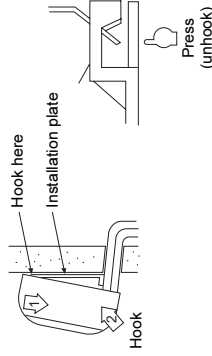

- For detaching the indoor unit from the installation plate, pull the indoor unit toward you while pushing its bottom up at the specified parts.

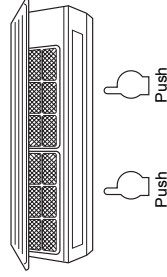

8. Drainage

- Run the drain hose sloped downwards.

NOTE

- Hole should be made at a slight downward slant on the outdoor side.

- Put water in the drain pan and confirm that the water is drained out of doors.
- Before connecting extension drain hose, insulate the connecting part of extension drain hose with shield pipe.

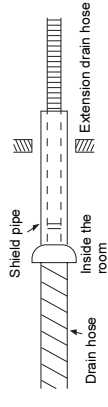
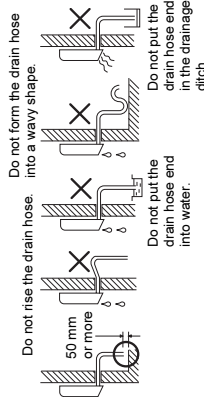

CAUTION

Arrange the drain pipe for proper drainage from the unit.
Improper drainage can result in dew-dropping.

This air conditioner has the structure designed to drain water collected from dew, which forms on the back of the indoor unit, to the drain pan. Therefore, do not store the power cord and other parts at a height above the drain guide.

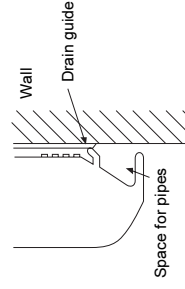

9. Refrigerant Piping

■ Refrigerant piping

- 1 Use copper pipe with 0.8 mm or more thickness. (In case pipe size is dia. 15.9, with 1.0 mm or more.)
- 2 Flare nut and flare works are also different from those of the conventional refrigerant. Take out the flare nut attached to the main unit of the air conditioner, and use it.

REQUIREMENT

When the refrigerant pipe is long, provide support brackets at intervals of 2.5 to 3 m to clamp the refrigerant pipe. Otherwise, abnormal sound may be generated.

⚠ CAUTION

IMPORTANT 4 POINTS FOR PIPING WORK

1. Remove dust and moisture from the inside of the connecting pipes.
2. Tight connection (between pipes and unit)
3. Evacuate the air in the connecting pipes using VACUUM PUMP.
4. Check the gas leakage. (Connected points)

■ Pipe size

Gas side	9.5	(dia.: mm)
Liquid side	6.4	

■ Permissible piping length and height difference

They vary according to the outdoor unit. For details, refer to the Installation Manual attached to the outdoor unit.

Flaring

- Cut the pipe with a pipe cutter. Remove burrs completely.
- Insert a flare nut into the pipe, and flare the pipe. As the flaring sizes of R410A differ from those of refrigerant R22, the flare tools newly manufactured for R410A are recommended.

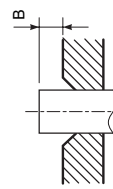

However, the conventional tools can be used by adjusting projection margin of the copper pipe.

▼ Projection margin in flaring: B (Unit: mm) Rigid (Clutch type)

Outer dia. of copper pipe	R410A tool used	Conventional tool used
6.4, 9.5	0 to 0.5	1.0 to 1.5
12.7, 15.9		

▼ Flaring dia. meter size: A (Unit: mm)

Outer dia. of copper pipe	A ^{*)}
R410A	
6.4	9.1
9.5	13.2
12.7	16.6
15.9	19.7

- * In case of flaring for R410A with the conventional flare tool, pull it out approx. 0.5 mm more than that for R22 to adjust to the specified flare size. The copper pipe gauge is useful for adjusting projection margin size.

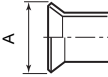

Tightening connection

⚠ CAUTION

- Do not apply excessive torque. Otherwise, the nut may crack depending on the conditions.

Outer dia. of copper pipe	Tightening torque (Unit: N·m)
6.4 mm	14 to 18 (1.4 to 1.8 kgf·m)
9.5 mm	33 to 42 (3.3 to 4.2 kgf·m)
12.7 mm	50 to 62 (5.0 to 6.2 kgf·m)
15.9 mm	63 to 77 (6.3 to 7.7 kgf·m)

▼ Tightening torque of flare pipe connections

Pressure of R410A is higher than that of R22. (Approx. 1.6 times) Therefore, using a torque wrench, tighten the flare pipe connecting sections which connect the indoor and outdoor units of the specified tightening torque.

Incorrect connections may cause not only a gas leak, but also a trouble of the refrigeration cycle. Align the centres of the connecting pipes and tighten the flare nut as far as possible with your fingers. Then tighten the nut with a spanner and torque wrench as shown in the figure.

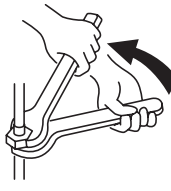

Work using double spanner

⚠ CAUTION

Tightening with an excessive torque may crack the nut depending on installation conditions. Tighten the nut within the specified tightening torque.

■ Airtight test / air purge, etc.

For air tightness test, adding refrigerant, refer to the Installation Manual attached to the outdoor unit.

⚠ CAUTION

Do not supply power to the indoor unit until the airtight test and vacuuming are completed. (If the indoor unit is powered on, the pulse motor valve is fully closed, which extends the time for vacuuming.)

■ Open the valve fully

Open the valve of the outdoor unit fully.

Heat insulation

Heat insulation for the pipes should be done separately for the liquid side and gas side. Because both of the liquid and gas side pipes become a low temperature during cooling operation, sufficient heat insulation should be done to prevent condensation.

- Heat insulator with a heat resistance of 120 °C or more must be used for the gas side pipe.
- The pipe connection section of the indoor unit must be heat insulated securely and compactly with the attached heat insulator.

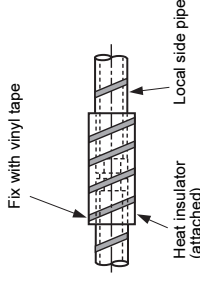

10. Electric Work

WARNING

- Use the specified wires for wiring connect the terminals. Securely fix them to prevent external forces applied to the terminals from affecting the terminals.
- Incomplete connection or fixation may cause a fire or other trouble.
- Connect earth wire. (grounding work)
- Incomplete grounding cause an electric shock.
- Do not connect earth wires to gas pipes, water pipes, lightning conductor or telephone earth wires.
- Appliance shall be installed in accordance with national wiring regulations.
- Capacity shortage of power circuit or incomplete installation may cause an electric shock or a fire.

CAUTION

- If incorrect / incomplete wiring is carried out, it will cause an electrical fire or smoke.
- Install an earth leakage breaker that is not tripped by shock waves.
- If an earth leakage breaker is not installed, an electric shock may be caused.
- Use the cord clamps attached to the product.
- Do not damage or scratch the conductive core and inner insulator of power and inter-connecting wires during peeling them.
- Use the power cord and Inter-connecting wire of specified thickness, type, and protective devices required.
- Do not connect 220 V ~ 240 V power to the terminal blocks (Ⓢ), (Ⓣ), (ⓐ), (ⓑ) for control wiring. (Otherwise, the system will fail.)
- Perform the electric wiring so that it does not come to contact with the high-temperature part of the pipe. The coating may melt resulting in an accident.

REQUIREMENT

- For power supply wiring, strictly conform to the Local Regulation in each country.
- For wiring of power supply of the outdoor units, follow the Installation Manual of each outdoor unit.
- Perform the electric wiring so that it does not come to contact with the high-temperature part of the pipe. The coating may melt resulting in an accident.
- After connecting wires to the terminal blocks, provide a trap and fix wires with the cord clamp.
- Run the refrigerant piping line and control wiring line in the same line.
- Do not turn on the power of the indoor unit until vacuuming of the refrigerant pipes completes.

■ Power supply wire and communication wires specifications

Power supply wire and communication wires are procured locally.

For the power supply specifications, follow to the following table. If capacity is little, it is dangerous because overheat or burnout may be caused.

For specifications of the power capacity of the outdoor unit and the power supply wires, refer to the Installation Manual attached to the outdoor unit.

Indoor unit power supply

- For the power supply of the indoor unit, prepare the exclusive power supply separated from that of the outdoor unit.
- Arrange the power supply, circuit breaker, and main switch of the indoor unit connected to the same outdoor unit so that they are commonly used.
- Power supply wire specification: Cable 3-core 2.5 mm², in conformity with Design 60245 IEC 57.

▼ Power supply

Power supply	220 V ~ 240 V ~, 50 Hz 220 V ~, 60 Hz
Power supply switch / circuit breaker or power supply wiring / fuse rating for indoor units should be selected by the accumulated total current values of the indoor units.	
Power supply wiring	Below 50 m 2.5 mm ²

Control wiring, Central controller wiring

- 2-core with polarity wires are used for the Control wiring between indoor unit and outdoor unit and Central controller wiring.
- To prevent noise trouble, use 2-core shield wire.
- The length of the communication line means the total length of the inter-unit wire length between indoor and outdoor units added with the central control system wire length.

▼ Communication line

Control wiring between indoor units, and outdoor unit (2-core shield wire)	Wire size (Up to 1000 m) 1.25 mm ² (Up to 2000 m) 2.0 mm ²
Central control line wiring (2-core shield wire)	Wire size (Up to 1000 m) 1.25 mm ² (Up to 2000 m) 2.0 mm ²

Wired remote controller wiring

- 2-core with non-polarity wire is used for wiring of the remote controller wiring and group remote controllers wiring.

Remote controller wiring, remote controller inter-unit wiring	Wire size: 0.5 mm ² to 2.0 mm ²	
Total wire length of remote controller wiring and remote controller inter-unit wiring = L + L1 + L2 + ... Ln	In case of wired type only	Up to 500 m
	In case of wireless type included	Up to 400 m
Total wire length of remote controller inter-unit wiring = L1 + L2 + ... Ln		Up to 200 m

CAUTION

The remote controller wire (Communication line) and AC 220 – 240 V wires cannot be parallel to contact each other and cannot be stored in the same conduits. If doing so, a trouble may be caused on the control system due to noise or other factor.

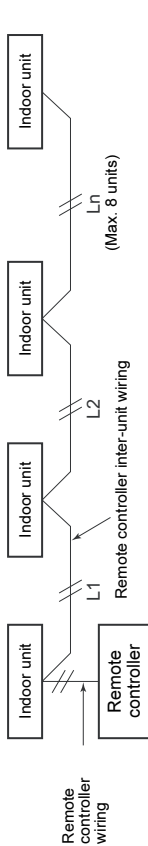

Wiring between indoor and outdoor units

NOTE

An outdoor unit connected with control wiring between indoor and outdoor units wire becomes automatically the header unit.

Wiring example

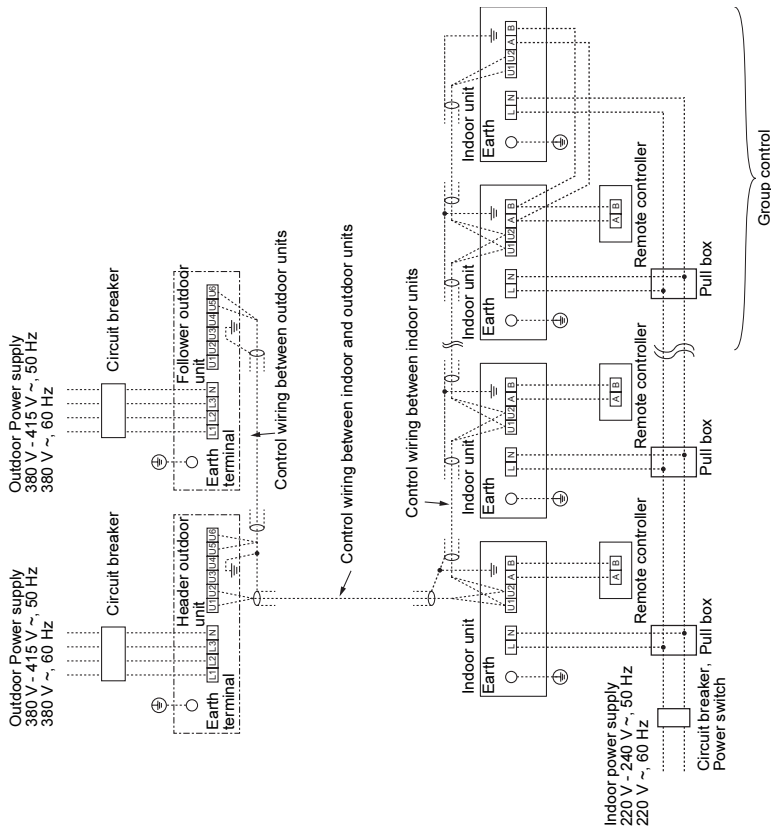

Wired remote controller wiring

- As the wired remote controller wire has non-polarity, there is no problem if connections to indoor unit terminal blocks A and B are reversed.

Wiring diagram

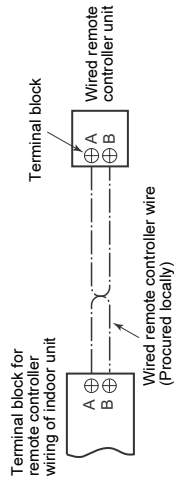

Address setup

Set up the addresses as per the Installation Manual supplied with Outdoor unit.

■ Wiring connection

How to connect the power supply wiring and control wiring

1. Remove the air intake grille. Open the air intake grille upward and pull it toward you.
2. Remove the four screws securing the front panel.
3. Slightly open the lower part of the front panel then pull the upper part of the front panel toward you to remove it from the rear plate.
4. Remove the terminal cover.
5. Insert the power supply wire and control wire (according to the local rule) into the pipe hole on the wall.
6. Take the power supply wire and the control wire out of the cable slot on the rear panel so that it protrudes about 150 mm from the front.
7. Insert the power supply wire fully into the terminal block and secure it tightly with screws. Tightening torque: 1.2 N·m (0.12 kgf·m) Secure the earth line with the earth screw.
8. Insert the control wire fully into the control / wired remote controller terminal block (ⓐ, ⓑ), and secure it tightly with screws.
9. Clamp the power supply wire and the control wire with the cord clamp.
10. Attach the terminal cover, the front panel and the air intake grille to the indoor unit.

⚠ CAUTION

- Refer to the wiring diagram attached inside the front panel.
- Check local electrical cords and also any specific wiring instructions and limitations.

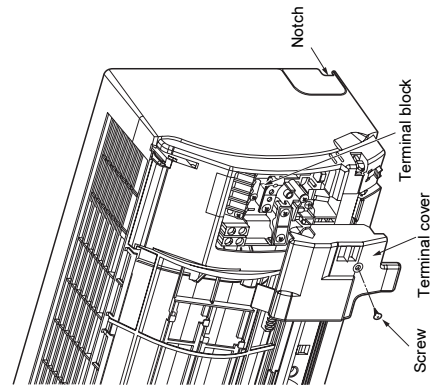
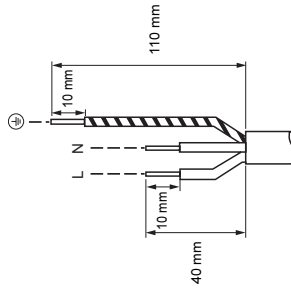
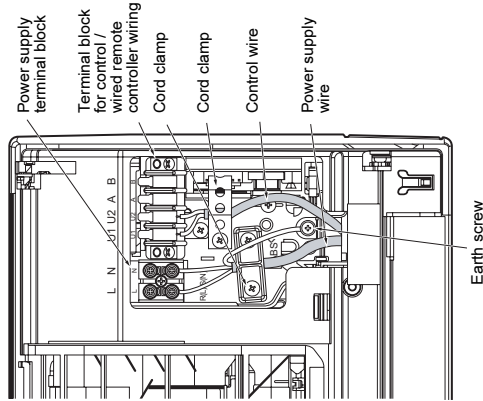
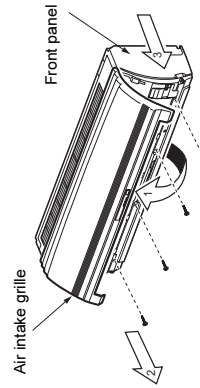

■ Wiring connection for the flow selector unit

Connect the wiring of the flow selector unit

Connect the power supply wire and the communication wire supplied with the flow selector unit to the indoor unit.

1. Remove the air intake grille. Open the air intake grille upward and pull it toward you.
2. Remove the four screws securing the front panel.
3. Slightly open the lower part of the front panel, and then pull the upper part of the front panel toward you to remove it from the rear plate.
4. Remove the wiring cover and cord clamp for right side of indoor unit.
5. Insert the power supply wire fully into the terminal block and secure it tightly with screws. Tightening torque: 1.2 N·m (0.12 kgf·m) Secure the earth line with the earth screw.
6. Connect the control wire connector of the flow selector unit to the lead with a connector to the under of the terminal block.
7. Take the control wire outwards through the slit of the terminal block.
8. Clamp the power supply wire and control wire of the flow selector unit tight with the cord clamp.
9. Attach the wiring cover, the front panel and the air intake grille to the indoor unit.

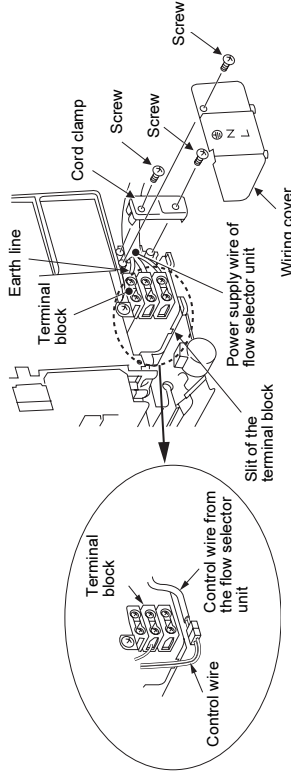

⚠ CAUTION

Confirm that every wires are stored in the electrical control box without getting caught before attaching the terminal cover.

11. Applicable Controls

A wired remote controller is necessary for this function. This function cannot be operate with a wireless remote controller.

REQUIREMENT

- When this air conditioner is used for the first time, it takes approx. 5 minutes until the remote controller becomes available after power-on. This is normal.
- When power is turned on for the first time after installation**> It takes approx. 5 minutes until the remote controller becomes available.

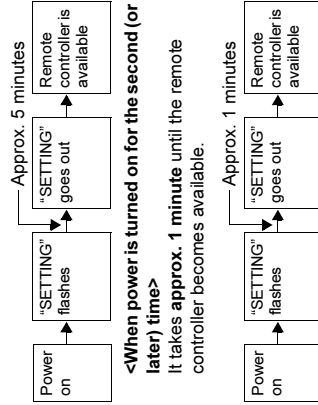

<When power is turned on for the second (or later) time>
It takes approx. 1 minute until the remote controller becomes available.

- Normal settings were made as factory default. Change the indoor unit settings as required.
- Use the wired remote controller to change the settings.
- The settings cannot be changed using the wireless remote controller, sub remote controller, or remote-controller less system (for central remote controller only). Therefore, install the wired remote controller to change the settings.

2 Each time UNIT LOCKER button is pushed, indoor unit numbers in the control group change cyclically. Select the indoor unit to change settings for.

The fan of the selected unit runs and the louvers start swinging. The indoor unit for change settings can be confirmed.

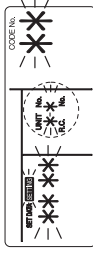

3 Specify CODE No. [* * *] with "TEMP." / < button.

4 Select SET DATA [* * * * *] with "TIME" / < button.

5 Push SET button. When the display changes from flashing to lit, the setup is completed.

- To change settings of another indoor unit, repeat from Procedure 2.
- To change other settings of the selected indoor unit, repeat from Procedure 3.
- Use SET button to clear the settings.
- To make settings after SET button was pushed, repeat from Procedure 2.

6 When settings have been completed, push TEST button to determine the settings.

When TEST button is pushed, "SETTING" flashes and then the display content disappears and the air conditioner enters the normal stop mode. (While "SETTING" is flashing, no operation of the remote controller is accepted.)

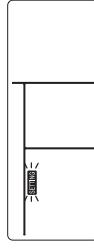

Filter sign setting

According to the installation condition, the lighting time of the filter sign (Notification of filter cleaning) can be changed. Follow to the basic operation procedure (1 → 2 → 3 → 4 → 5 → 6).

- For the CODE No. in Procedure 3, specify [01].
- For the SET DATA in Procedure 4, select the SET DATA of filter sign term from the following table.

SET DATA	Filter sign term
0000	None
0001	150 H (Factory default)
0002	2500 H
0003	5000 H
0004	10000 H

To secure better effect of heating

When it is difficult to obtain satisfactory heating due to installation place of the indoor unit or structure of the room, the detection temperature of heating can be raised. Also use a circulator, etc. to circulate heat air near the ceiling.

Follow to the basic operation procedure

- (1 → 2 → 3 → 4 → 5 → 6).
- For the CODE No. in Procedure 3, specify [06].
- For the SET DATA in Procedure 4, select the SET DATA of shift value of detection temperature to be set up from the table below.

SET DATA	Detection temp shift value
0000	No shift
0001	+1 °C
0002	+2 °C (Factory default)
0003	+3 °C
0004	+4 °C
0005	+5 °C
0006	+6 °C

Basic procedure for changing settings

Change the settings while the air conditioner is not working. (Stop the air conditioner before making settings.)

The display content for setting differs from that on the former types of remote controller (RBC-AMT21E / AMT31E). (The number of CODE No. has increased.)

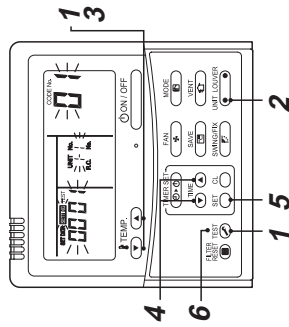

1 Push TEST button and "TEMP." / < button simultaneously for at least 4 seconds.

After a while, the display flashes as shown in the figure.

- Confirm that the CODE No. is [01].
- If the CODE No. is not [01], push TEST button to erase the display content, and repeat the procedure from the beginning. (No operation of the remote controller is accepted for a while after TEST button is pushed.) (While air conditioners are operated under the group control, "ALL" is displayed first. When "CODE No." is pushed, the indoor unit number displayed following "ALL" is the header unit.)

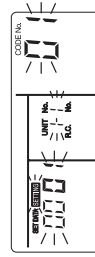

(* Display content varies with the indoor unit model.)

Remote controller sensor

The temperature sensor of the indoor unit senses room temperature usually. Set the remote controller sensor to sense the temperature around the remote controller.

Select items following the basic operation procedure

- (1 → 2 → 3 → 4 → 5 → 6).
- Specify [32] for the CODE No. in Procedure 3.
- Select the following data for the SET DATA in Procedure 4.

SET DATA	0000	0001
Remote controller sensor	Not used (Factory default)	Used

When  flashes, the remote controller sensor is defective. Select the SET DATA [0000] (not used) or replace the remote controller.

Group control

In a group control, a remote controller can control up to maximum 8 units.

- The wired remote controller only can control a group control. The wireless remote controller is unavailable for this control.
- For cabling procedure and cables of the individual line (Identical refrigerant line) system, refer to "Electric work" in this Manual.
- Cabling between indoor units in a group is performed in the following procedure. Connect the indoor units by connecting the remote controller inter-unit cables from the remote controller terminal blocks (A, B) of the indoor unit connected with a remote controller to the remote controller terminal blocks (A, B) of the other indoor unit. (Non-polarity)
- For address setup, refer to the Installation Manual attached to the outdoor unit.

NOTE

"1:1 Model" Connection Interface (Model TCB-PCNT30TLE2) can not connect to this High Wall type air conditioner.

Adjustment of air direction

1 Using the remote controller switch, change the up / down air direction by moving the horizontal louver.

2 Adjust the right / left air direction by bending the vertical grille inside of the air discharge port with hands.

REQUIREMENT

Do not touch the horizontal louver directly with hands; otherwise a trouble may be caused. For handling of the horizontal louver, refer to "Owner's Manual".

12. Test Run

A wired remote controller is necessary for this function. This function cannot be operate with a wireless remote controller.

Wired remote controller

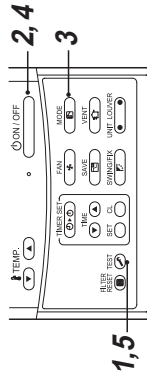

- Push **TEST** button for 4 seconds or more. **[TEST]** is displayed on the display part and the selection of mode in the test mode is permitted.

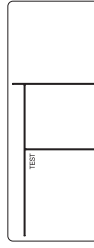

- Push **ON/OFF** button.

- Select the operation mode with button, **[COOL]** or **[HEAT]**.

- Do not run the air conditioner in a mode other than **[COOL]** or **[HEAT]**.
- The temperature controlling function does not work during test run.
- The detection of error is performed as usual.

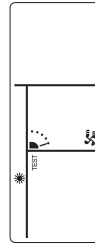

Execute a test run

Using the wired remote controller, operate the unit as usual.

For the procedure of the operation, refer to the attached Owner's Manual.

A forced test run can be executed in the following procedure even if the operation stops by thermo.-OFF.

In order to prevent a serial operation, the forced test run is released after 60 minutes have passed and returns to the usual operation.

CAUTION

- Do not use the forced test run for cases other than the test run because it applies an excessive load to the devices.

4 After the test run, push  button to stop a test run.
(Display part is same as procedure 1.)

5 Push  button to cancel (release from) the test run mode.
(TEST) disappears on the display and the status returns to a normal.)

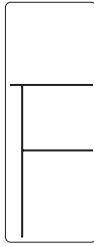

Wireless remote controller (Forced test operation is performed in a different way.)

REQUIREMENT

- For the operation procedure, follow the Owner's Manual.
- Finish the forced cooling operation in a short time because it applies excessive strength to the air conditioner.
- A test operation of forced heating is unavailable. Perform a test operation by heating operation using the switches of the remote controller. However heating operation may be not carried out according to the temperature conditions.

- Check wiring / piping of indoor and outdoor units

1 When "TEMPORARY" button is pushed for 10 seconds or more, "PI!" sound is heard and the operation changes to a forced cooling operation. After approx. 3 minutes, a cooling operation starts forcibly.

Check cool air starts blowing. If the operation does not start, check wiring again.

2 To stop a test operation, push "TEMPORARY" button once again (Approx. 1 second).

The louver closes and the operation stops.

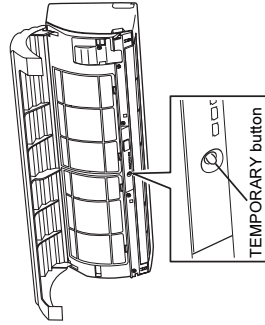

- Check transmission of remote controller

1 Push "START / STOP" button of the remote controller to check an operation can also start by the remote controller.

- "Cooling" operation by the remote controller may be unavailable according to the temperature conditions.
Check wiring / piping of the indoor and outdoor units in forced cooling operation.

13. Troubleshooting

A wired remote controller is necessary for this function. This function cannot be operate with a wireless remote controller.

Confirmation and check

When an error occurred in the air conditioner, the check code and the indoor UNIT No. appear on the display part of the remote controller.

The check code is only displayed during the operation.

If the display disappears, operate the air conditioner according to the following "Confirmation of error log" for confirmation.

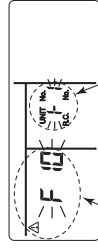

Check code

Indoor UNIT No. in which an error occurred

Confirmation of error log

When an error occurred on the air conditioner, the error log can be confirmed with the following procedure. (The error log is stored in memory up to 4 errors.)

The log can be confirmed from both operating status and stop status.

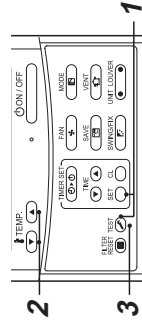

1 When  and  buttons are pushed simultaneously for 4 seconds or more, the following display appears.

If [Service check] is displayed, the mode enters in the error log mode.

- [01: Order of error log] is displayed in CODE No. window
- [Check code] is displayed in CHECK window.
- [Indoor unit address in which an error occurred] is displayed in UNIT No.

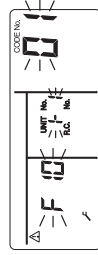

Check method

On the wired remote controller, central control remote controller and the interface P. C. board of the outdoor unit (I/F), a check display LCD (Remote controller) or 7-segment display (on the outdoor interface P. C. board) to display the operation is provided. Therefore the operation status can be known. Using this self-diagnosis function, a trouble or position with error of the air conditioner can be found as shown in the table below.

Check code list

The following list shows each check code. Find the check contents from the list according to part to be checked.

- In case of check from indoor remote controller: See "Wired remote controller display" in the list.
- In case of check from outdoor unit: See "Outdoor unit 7-segment display" in the list.
- In case of check from AI-NET central control remote controller: See "AI-NET central control display" in the list.
- In case of check from indoor unit with a wireless remote controller: See "Sensor block display of receiving unit" in the list.

○: Lighting, □: Flashing, ●: Goes off
AI-NET: Artificial Intelligence

IPDU: Intelligent Power Drive Unit

ALT: Flashing is alternately when there are two flashing LED.

SIM: Simultaneous flashing when there are two flashing LED.

Wired remote controller display	Check code		Wireless remote controller			Judging device		
	Outdoor unit 7-segment display	AI-NET central control display	Sensor block display of receiving unit		Check code name			
	Auxiliary code		Operation	Timer		Ready	Flash	
E01	—	—	□	●	●		Communication error between indoor unit and remote controller (Detected at remote controller side)	Remote controller
E02	—	—	□	●	●		Remote controller transmission error	Remote controller
E03	—	97	□	●	●		Communication error between indoor unit and remote controller (Detected at indoor unit side)	Indoor unit
E04	—	04	●	●	□		Communication circuit error between indoor / outdoor unit (Detected at indoor unit side)	Indoor unit
E06	No. of indoor units in which sensor has been normally received	04	●	●	□		Decrease of No. of indoor units	I/F
E07	—	—	●	●	□		Communication circuit error between indoor / outdoor unit (Detected at outdoor unit side)	I/F
E08	Duplicated indoor unit addresses	96	□	●	●		Duplicated indoor unit addresses	Indoor unit / I/F

Wired remote controller display	Check code		Wireless remote controller			Judging device		
	Outdoor unit 7-segment display	AI-NET central control display	Sensor block display of receiving unit		Check code name			
	Auxiliary code		Operation	Timer		Ready	Flash	
E09	—	99	□	●	●		Duplicated master remote controllers	Remote controller
E10	—	CF	□	●	●		Communication error between indoor unit MC	Indoor unit
E12	01:Indoor / Outdoor units communication 02:Outdoor / Outdoor units communication	42	□	●	●		Automatic address start error	I/F
E15	—	42	●	●	□		No indoor unit during automatic addressing	I/F
E16	00:Capacity over 01~No. of connected units	89	●	●	□		Capacity over / No. of connected indoor units	I/F
E18	—	97, 99	□	●	●		Communication error between header and follower units Indoor unit	Indoor unit
E19	00:No header 02:Two or more header units	96	●	●	□		Outdoor header units quantity error	I/F
E20	01:Outdoor unit of other line connected 02:Indoor unit of other line connected	42	●	●	□		Other line connected during automatic address	I/F
E21	02:No header unit 00:Multiple number of header units	42	●	●	□		Error in number of heat storage master units	I/F
E22	—	42	●	●	□		Reduction in number of heat storage units	I/F
E23	—	15	●	●	□		Sending error in communication between outdoor units Error in number of heat storage units (trouble with reception)	I/F
E25	—	15	●	●	□		Duplicated follower outdoor addresses	I/F
E26	No. of outdoor units which received signal normally	15	●	●	□		Decrease of No. of connected outdoor units	I/F
E28	Detected outdoor unit number	d2	●	●	□		Follower outdoor unit error	I/F

Wired remote controller display	Check code	Outdoor unit 7-segment display	AI-NET central control display	Wireless remote controller			Check code name	Judging device
				Operation	Timer	Ready		
E31	E31	Number of IPDU (-1)	CF	●	●	□	IPDU communication error	I/F
F01	—	—	0F	□	□	●	Indoor unit TCJ sensor error	Indoor unit
F02	—	—	0d	□	□	●	Indoor unit TC2 sensor error	Indoor unit
F03	—	—	93	□	□	●	Indoor unit TC1 sensor error	Indoor unit
F04	F04	—	19	□	□	○	TD1 sensor error	I/F
F05	F05	—	A1	□	□	○	TD2 sensor error	I/F
F06	F06	01:TE1 sensor	18	□	□	○	TE1 sensor error	I/F
F07	F07	02:TE2 sensor	18	□	□	○	TE2 sensor error	I/F
F08	F08	—	1b	□	□	○	TL sensor error	I/F
F10	—	—	0C	□	□	●	TO sensor error	I/F
F12	F12	—	A2	□	□	○	Indoor unit TA sensor error	Indoor unit
F13	F13	01:Comp. 1 side	43	□	□	○	TST1 sensor error	I/F
F15	F15	02:Comp. 2 side	—	□	□	○	TH sensor error	IPDU
F16	F16	03:Comp. 3 side	—	□	□	○	Outdoor unit temp. sensor miscabling (TE, TL)	I/F
F22	F22	—	B2	□	□	○	Outdoor unit pressure sensor miscabling (Pd, Ps)	I/F
F23	F23	—	43	□	□	○	TD3 sensor error	I/F
F24	F24	—	43	□	□	○	Ps sensor error	I/F
F29	—	—	12	□	□	●	Pd sensor error	I/F
F31	F31	—	1C	□	□	○	Indoor unit other error	Indoor unit
H01	H01	01:Comp. 1 side	IF	●	●	●	Indoor unit EEPROM error	I/F
H02	H02	02:Comp. 2 side	IF	●	●	●	Compressor break down	IPDU
H03	H03	03:Comp. 3 side	IF	●	●	●	Compressor trouble (lock)	IPDU
H04	H04	01:Comp. 1 side	1d	●	●	●	Current detect circuit system error	IPDU
H05	H05	02:Comp. 2 side	17	●	●	●	Compressor circuit system error	IPDU
H06	H06	03:Comp. 3 side	44	●	●	●	Comp. 1 case thermo operation	I/F
H07	H07	—	—	●	●	●	TD1 sensor miscabling	I/F
H08	H08	—	20	●	●	●	Low pressure protective operation	I/F
H09	H09	—	d7	●	●	●	Oil level down defective protection	I/F

Wired remote controller display	Check code	Outdoor unit 7-segment display	AI-NET central control display	Wireless remote controller			Check code name	Judging device
				Operation	Timer	Ready		
H08	H08	01:TK1 sensor error	d4	●	□	●	Oil level defective temp sensor error	I/F
H14	H14	02:TK2 sensor error	44	●	□	●	Comp. 2 case thermo operation	I/F
H15	H15	03:TK3 sensor error	—	●	□	●	TD2 sensor miscabling	I/F
H16	H16	04:TK4 sensor error	d7	●	□	●	Oil level defective circuit error	I/F
H25	H25	05:TK5 sensor error	—	●	□	●	TD3 sensor miscabling	I/F
L03	—	01:TK1 oil circuit system error	96	□	●	□	Indoor unit centre unit duplicated	Indoor unit
L04	L04	02:TK2 oil circuit system error	96	□	○	□	Outdoor unit line address duplicated	I/F
L05	—	03:TK3 oil circuit system error	96	□	●	□	Duplicated indoor units with priority (Displayed in indoor unit with priority)	I/F
L06	L06	04:TK4 oil circuit system error	96	□	●	□	Duplicated indoor units with priority (Displayed in unit other than indoor unit with priority)	I/F
L07	—	05:TK5 oil circuit system error	99	□	●	□	Group line in individual indoor unit	Indoor unit
L08	L08	No. of indoor units with priority	99	□	●	□	Indoor unit group / Address unset	Indoor unit / I/F
L09	—	—	46	□	●	□	Indoor unit capacity unset	Indoor unit
L10	L10	—	88	□	○	□	Outdoor unit capacity unset	I/F
L17	—	—	46	□	○	□	Outdoor unit type mismatch error	I/F
L20	—	—	98	□	○	□	Duplicated central control addresses	AI-NET, Indoor unit
L26	L26	Number of heat storage units connected	46	□	○	□	Too many heat storage units connected	I/F

Wired remote controller display	Check code		Wireless remote controller			Judging device
	Outdoor unit 7-segment display	AI-NET central control display	Sensor block display of receiving unit			
			Operation	Timer	Ready	
L27	Number of heat storage units connected	46	□	○	□	I/F
L28	—	46	□	○	□	I/F
L29	Number of IPDU (*)	CF	□	○	□	I/F
L30	Detected indoor unit address	b6	□	○	□	Indoor unit
—	L31	—	—	—	—	I/F
P01	—	11	●	□	□	Indoor unit
P03	P03	1E	□	●	□	I/F
P04	P04	21	□	●	□	IPDU
P05	P05	AF	□	●	□	I/F
P07	P07	IC	□	●	□	IPDU, I/F
P09	P09	47	●	□	□	Heat storage unit
P10	P10	Ob	●	□	□	Indoor unit
P12	P12	11	●	□	□	Indoor unit
P13	P13	47	●	□	□	I/F
P15	P15	AE	□	●	□	I/F
P17	P17	bb	□	●	□	I/F
P18	P18	E2	□	●	□	I/F
P19	P19	O8	□	●	□	I/F
P20	P20	22	□	●	□	I/F

Wired remote controller display	Check code		Wireless remote controller			Judging device
	Outdoor unit 7-segment display	AI-NET central control display	Sensor block display of receiving unit			
			Operation	Timer	Ready	
P22	P22	1A	□	●	□	IPDU
P26	P26	14	□	●	□	IPDU
P29	P29	16	□	●	□	IPDU
P31	P31	47	□	●	□	Indoor unit
—	—	b7	By alarm device			AI-NET
—	—	97	—			AI-NET
—	—	99	—			AI-NET

*1 Number of IPDU

- 01: Comp. 1
- 02: Comp. 2
- 03: Comp. 1 + Comp. 2
- 04: Comp. 3
- 05: Comp. 1 + Comp. 3
- 06: Comp. 2 + Comp. 3
- 07: Comp. 1 + Comp. 2 + Comp. 3
- 08: Fan
- 09: Comp. 1 + Fan
- 0A: Comp. 2 + Fan
- 0B: Comp. 1 + Comp. 2 + Fan
- 0C: Comp. 3 + Fan

- 0D: Comp. 1 + Comp. 3 + Fan
- 0E: Comp. 2 + Comp. 3 + Fan
- 0F: Comp. 1 + Comp. 2 + Comp. 3 + Fan

Error detected by TCC-LINK central control device

Central control device indication	Check code		Wireless remote controller				Judging device	
	Outdoor unit 7-segment display	Auxiliary code	Sensor block display of receiving unit			Check code name		
			Operation	Timer	Ready			Flash
C05	—	—	—	—	—	—	Sending error in TCC-LINK central control device	TCC-LINK
C06	—	—	—	—	—	—	Receiving error in TCC-LINK central control device	TCC-LINK
C12	—	—	—	—	—	—	Batch alarm of general-purpose equipment control interface	General-purpose equipment, I/F
P30	Differs according to error contents of unit with occurrence of alarm						Group control follower unit error	TCC-LINK
	(L20 is displayed.)							

TCC-LINK: TOSHIBA Carrier Communication Link.

Warnings on Refrigerant Leakage

Check of Concentration Limit

The room in which the air conditioner is to be installed requires a design that in the event of refrigerant gas leaking out, its concentration will not exceed a set limit.

The refrigerant R410A which is used in the air conditioner is safe, without the toxicity or combustibility of ammonia, and is not restricted by laws to be imposed which protect the ozone layer. However, since it contains more than air, it poses the risk of suffocation if its concentration should rise excessively. Suffocation from leakage of R410A is almost non-existent. With the recent increase in the number of high concentration buildings, however, the installation of multi air conditioner systems is on the increase because of the need for effective use of floor space, individual control, energy conservation by curtailing heat and carrying power etc.

Most importantly, the multi air conditioner system is able to replenish a large amount of refrigerant compared with conventional individual air conditioners. If a single unit of the multi conditioner system is to be installed in a small room, select a suitable model and installation procedure so that if the refrigerant accidentally leaks out, its concentration does not reach the limit (and in the event of an emergency, measures can be made before injury can occur).

In a room where the concentration may exceed the limit, create an opening with adjacent rooms, or install mechanical ventilation combined with a gas leak detection device. The concentration is as given below.

$$\frac{\text{Total amount of refrigerant (kg)}}{\text{Min. volume of the indoor unit installed room (m}^3\text{)}} \leq \text{Concentration limit (kg/m}^3\text{)}$$

The concentration limit of R410A which is used in multi air conditioners is 0.3 kg/m³.

▼ NOTE 1

If there are 2 or more refrigerating systems in a single refrigerating device, the amounts of refrigerant should be as charged in each independent device.

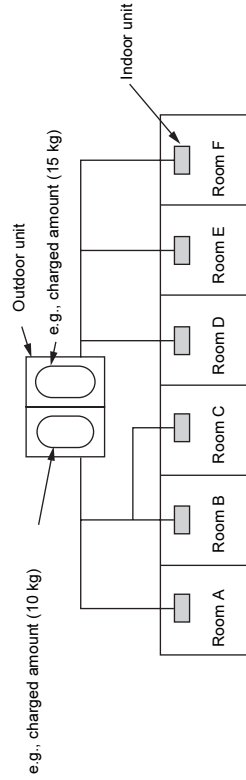

For the amount of charge in this example:

The possible amount of leaked refrigerant gas in rooms A, B and C is 10 kg.

The possible amount of leaked refrigerant gas in rooms D, E and F is 15 kg.

▼ NOTE 2

The standards for minimum room volume are as follows.

1. No partition (shaded portion)

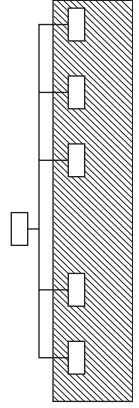

Important

- When there is an effective opening with the adjacent room for ventilation of leaking refrigerant gas (opening without a door, or an opening 0.15% or larger than the respective floor spaces at the top or bottom of the door).

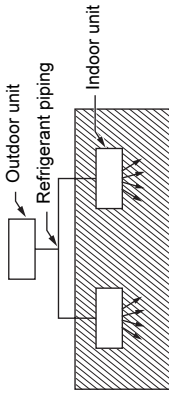

- If an indoor unit is installed in each partitioned room and the refrigerant piping is interconnected, the smallest room of course becomes the object. But when a mechanical ventilation is installed, interlocked with a gas leakage detector in the smallest room where the density limit is exceeded, the volume of the next smallest room becomes the object.

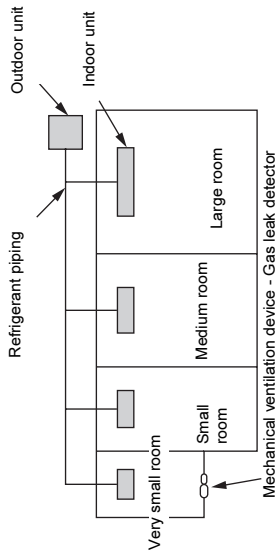

▼ NOTE 3
The minimum indoor floor area compared with the amount of refrigerant is roughly as follows:
(When the ceiling is 2.7 m high)

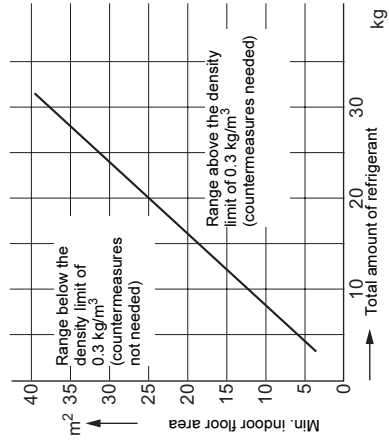

Confirmation of indoor unit setup

Prior to delivery to the customer, check the address and setup of the indoor unit, which has been installed in this time and fill the check sheet (Table below). Data of four units can be entered in this check sheet. Copy this sheet according to the No. of the indoor units. If the installed system is a group control system, use this sheet by entering each line system into each installation manual attached to the other indoor units.

REQUIREMENT

This check sheet is required for maintenance after installation. Fill this sheet and then pass this Installation Manual to the customers.

Indoor unit setup check sheet

Indoor unit		Indoor unit		Indoor unit		Indoor unit	
Room name	Room name	Room name	Room name	Room name	Room name	Room name	Room name
Model	Model	Model	Model	Model	Model	Model	Model
Check indoor unit address. (For check method, refer to APPLICABLE CONTROLS in this manual.)							
*In case of a single system, it is unnecessary to enter the indoor address. (CODE NO.: Line [12], Indoor [13], Group [14], Central control [03])							
Line	Indoor	Group	Line	Indoor	Group	Line	Indoor
Central control address		Central control address		Central control address		Central control address	
Various setup				Various setup			
Have you changed lighting time of filter sign? If not, fill check mark [x] in [NO CHANGE], and fill check mark [x] in [ITEM] if changed, respectively. (For check method, refer to APPLICABLE CONTROLS in this manual.)							
Filter sign lighting time (CODE NO. [01])		Filter sign lighting time (CODE NO. [01])		Filter sign lighting time (CODE NO. [01])		Filter sign lighting time (CODE NO. [01])	
<input type="checkbox"/> NO CHANGE	<input type="checkbox"/> [0000]	<input type="checkbox"/> NO CHANGE	<input type="checkbox"/> [0000]	<input type="checkbox"/> NO CHANGE	<input type="checkbox"/> [0000]	<input type="checkbox"/> NO CHANGE	<input type="checkbox"/> [0000]
<input type="checkbox"/> NONE	<input type="checkbox"/> [0001]	<input type="checkbox"/> NONE	<input type="checkbox"/> [0001]	<input type="checkbox"/> NONE	<input type="checkbox"/> [0001]	<input type="checkbox"/> NONE	<input type="checkbox"/> [0001]
<input type="checkbox"/> 150H	<input type="checkbox"/> [0002]	<input type="checkbox"/> 150H	<input type="checkbox"/> [0002]	<input type="checkbox"/> 150H	<input type="checkbox"/> [0002]	<input type="checkbox"/> 150H	<input type="checkbox"/> [0002]
<input type="checkbox"/> 2500H	<input type="checkbox"/> [0003]	<input type="checkbox"/> 2500H	<input type="checkbox"/> [0003]	<input type="checkbox"/> 2500H	<input type="checkbox"/> [0003]	<input type="checkbox"/> 2500H	<input type="checkbox"/> [0003]
<input type="checkbox"/> 5000H	<input type="checkbox"/> [0004]	<input type="checkbox"/> 5000H	<input type="checkbox"/> [0004]	<input type="checkbox"/> 5000H	<input type="checkbox"/> [0004]	<input type="checkbox"/> 5000H	<input type="checkbox"/> [0004]
<input type="checkbox"/> 10000H	<input type="checkbox"/> [0004]	<input type="checkbox"/> 10000H	<input type="checkbox"/> [0004]	<input type="checkbox"/> 10000H	<input type="checkbox"/> [0004]	<input type="checkbox"/> 10000H	<input type="checkbox"/> [0004]
Detected temp. shift value setup (CODE NO. [06])		Detected temp. shift value setup (CODE NO. [06])		Detected temp. shift value setup (CODE NO. [06])		Detected temp. shift value setup (CODE NO. [06])	
<input type="checkbox"/> NO CHANGE	<input type="checkbox"/> [0000]	<input type="checkbox"/> NO CHANGE	<input type="checkbox"/> [0000]	<input type="checkbox"/> NO CHANGE	<input type="checkbox"/> [0000]	<input type="checkbox"/> NO CHANGE	<input type="checkbox"/> [0000]
<input type="checkbox"/> NO SHIFT	<input type="checkbox"/> [0001]	<input type="checkbox"/> NO SHIFT	<input type="checkbox"/> [0001]	<input type="checkbox"/> NO SHIFT	<input type="checkbox"/> [0001]	<input type="checkbox"/> NO SHIFT	<input type="checkbox"/> [0001]
<input type="checkbox"/> +1°C	<input type="checkbox"/> [0002]	<input type="checkbox"/> +1°C	<input type="checkbox"/> [0002]	<input type="checkbox"/> +1°C	<input type="checkbox"/> [0002]	<input type="checkbox"/> +1°C	<input type="checkbox"/> [0002]
<input type="checkbox"/> +2°C	<input type="checkbox"/> [0003]	<input type="checkbox"/> +2°C	<input type="checkbox"/> [0003]	<input type="checkbox"/> +2°C	<input type="checkbox"/> [0003]	<input type="checkbox"/> +2°C	<input type="checkbox"/> [0003]
<input type="checkbox"/> +3°C	<input type="checkbox"/> [0004]	<input type="checkbox"/> +3°C	<input type="checkbox"/> [0004]	<input type="checkbox"/> +3°C	<input type="checkbox"/> [0004]	<input type="checkbox"/> +3°C	<input type="checkbox"/> [0004]
<input type="checkbox"/> +4°C	<input type="checkbox"/> [0005]	<input type="checkbox"/> +4°C	<input type="checkbox"/> [0005]	<input type="checkbox"/> +4°C	<input type="checkbox"/> [0005]	<input type="checkbox"/> +4°C	<input type="checkbox"/> [0005]
<input type="checkbox"/> +5°C	<input type="checkbox"/> [0006]	<input type="checkbox"/> +5°C	<input type="checkbox"/> [0006]	<input type="checkbox"/> +5°C	<input type="checkbox"/> [0006]	<input type="checkbox"/> +5°C	<input type="checkbox"/> [0006]
<input type="checkbox"/> +6°C	<input type="checkbox"/> [0006]	<input type="checkbox"/> +6°C	<input type="checkbox"/> [0006]	<input type="checkbox"/> +6°C	<input type="checkbox"/> [0006]	<input type="checkbox"/> +6°C	<input type="checkbox"/> [0006]
Incorporation of parts sold separately		Incorporation of parts sold separately		Incorporation of parts sold separately		Incorporation of parts sold separately	
<input type="checkbox"/> Others ()	<input type="checkbox"/> ()	<input type="checkbox"/> Others ()	<input type="checkbox"/> ()	<input type="checkbox"/> Others ()	<input type="checkbox"/> ()	<input type="checkbox"/> Others ()	<input type="checkbox"/> ()

10. HOW TO REPLACE MAIN PARTS

10-1. Indoor Unit

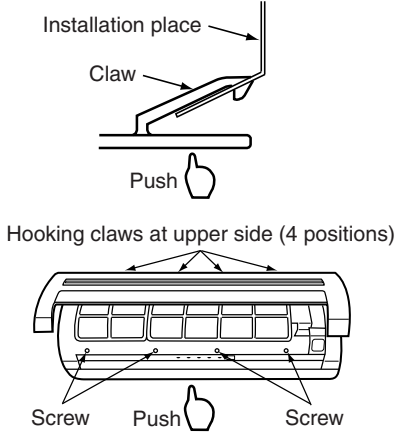
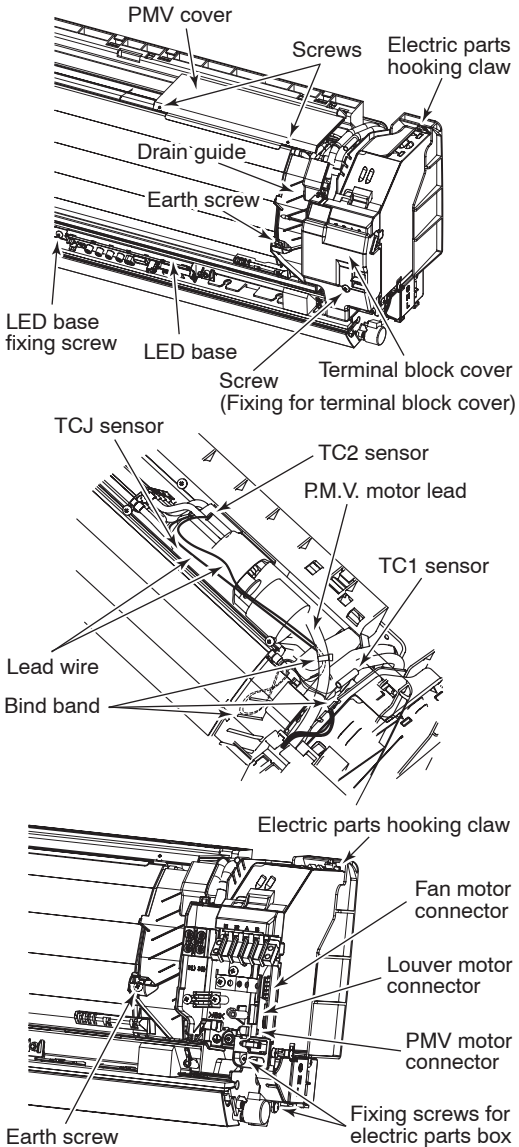
No.	Part name	Procedure	Remarks
①	Front panel	<p>1) Stop operation of the air conditioner, and then pull out the power supply plug from the plug socket.</p> <p>2) Open the suction grille, and then take off fixing screws of the front panel (4 pcs.).</p> <p>3) Push the electric parts box with right thumb while pulling the both sides of the front panel.</p> <p><Attachment of front panel></p> <p>1) Hang the hooking claws of the upper surface of the front panel (4 positions) to the rear plate, and then push a position at the center of the lower part of the discharge port.</p> <p>2) Tighten 4 screws.</p> <p>* When hooking or pushing is insufficient, dewdrop or abnormal sound may be caused.</p>	
②	Electric parts assembly	<p>1) Perform work of item ①.</p> <p>2) Take off fixing screws (2 pcs) of PMV cover, and then remove PMV cover.</p> <p>3) Remove binding band (2 positions) fixing the sensor lead wires. (When mounting electric parts, fix the sensor lead wires again with bundling band. Put bundling band on the positions as before and fasten wires.)</p> <p>4) Pull out TC1, TC2, TCJ sensors from sensor holder of heat exchanger. (Pay attention to mounting positions of each sensor when reassembling of electric parts. Be sure to apply marking, etc to TC2 and TCJ sensors before removing because their shapes are reassembled.)</p> <p>5) Take off LED base fixing screw (1 pc) and remove LED base.</p> <p>6) Remove terminal block cover, and then remove fan motor connector (5P), louver motor connector (5P), and PMV motor connector (6P) from microcomputer assembly.</p> <p>7) Take off fixing screws (2 pcs) of electric parts box, pull out slightly the electric parts box toward you, and then remove drain guide.</p> <p>8) Take off earth screws attached to end board of the heat exchanger.</p> <p>9) Pull off the electric parts box toward you.</p> <p><Caution in reassembling> When mounting the electric parts box to the main unit, follow the reverse procedure of removing. Return sensors and lead wires to the original positions according to the diagram.</p>	

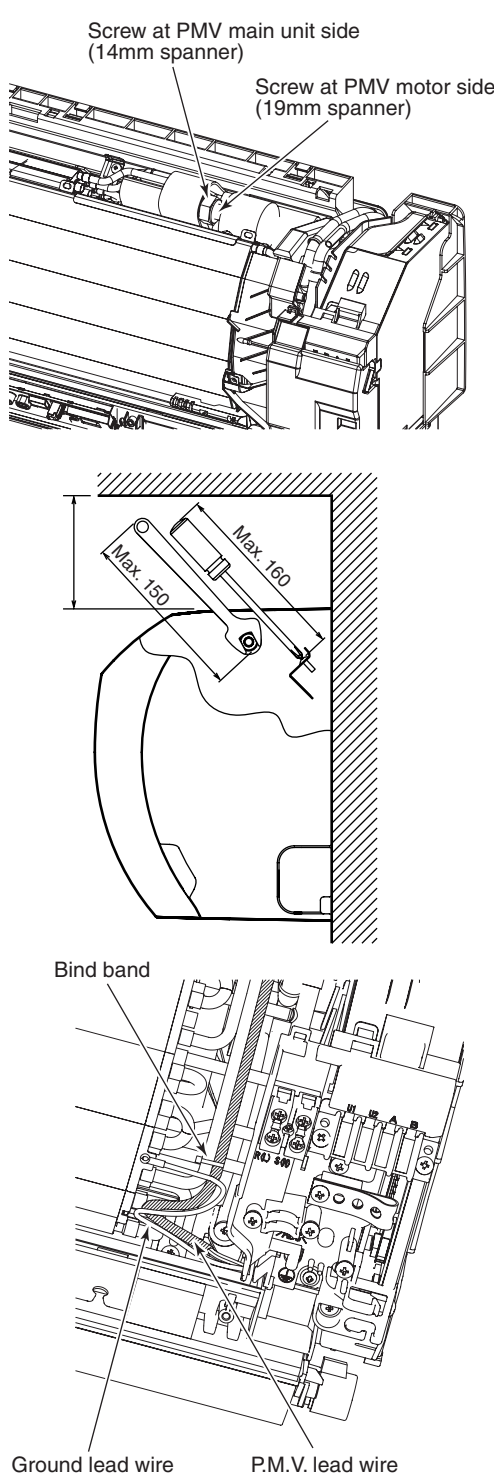
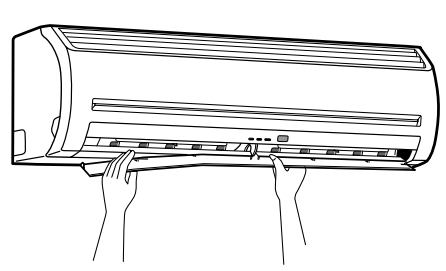
No.	Part name	Procedure	Remarks
③	PMV motor	<p><Caution in works> Use spanners to remove PMV motor. As the pipes are deformed, do not use monkey spanners. When there is 100 to the ceiling, use a spanner below mm.)</p> <ol style="list-style-type: none"> 1) Perform work of item ①. 2) Take off fixing screws (2 pcs) of PMV cover, and then remove PMV cover. 3) Remove connector (6P, Blue) for PMV motor from the electric parts box. 4) Take off bundling band of PMV motor lead wires. 5) Using a spanner, remove PMV motor. <p><Caution in reassembling> Draw out lead wires of PMV motor from positions same to original positions before removing.</p>	
④	Horizontal grille	<ol style="list-style-type: none"> 1) Remove shaft of the horizontal grille from the rear plate. (First remove the left shaft, and then remove the other shafts while sliding the horizontal grille leftward.) 	

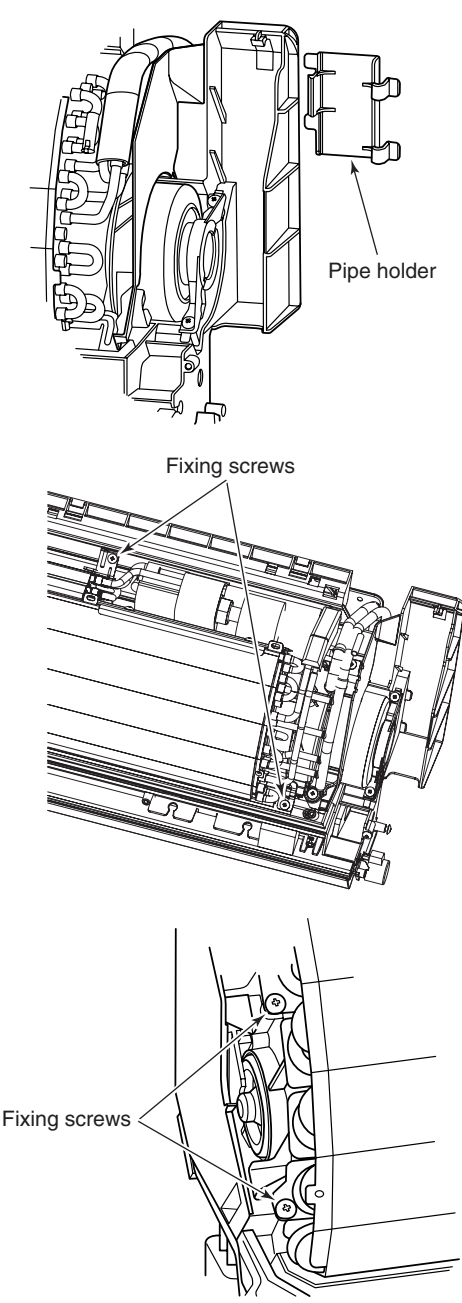
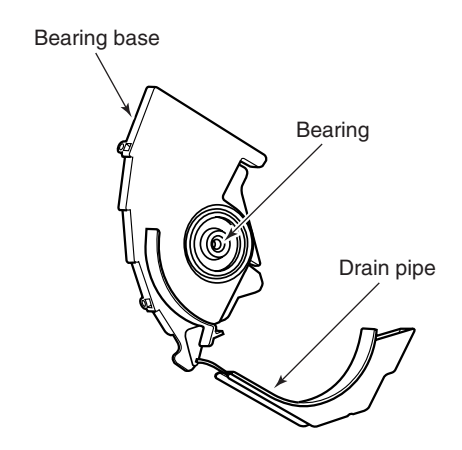
No.	Part name	Procedure	Remarks
⑤	Heat exchanger	1) Perform work of item ②. 2) Remove the pipe holder from the rear side of the main unit. 3) Take off fixing screws (2 pcs.) at the left side of the end plate of the heat exchanger. 4) Take off fixing screws (2 pcs.) at the right side of the heat exchanger.	 <p>Pipe holder</p> <p>Fixing screws</p> <p>Fixing screws</p>
⑥	Bearing	1) Perform works of items ①, ⑧-4), and ⑧-5), and then remove bearing from the bearing base. <Caution to reassembly> In case of shooting-out of bearing part from the housing, push into the specified position and incorporate in the main unit.	 <p>Bearing base</p> <p>Bearing</p> <p>Drain pipe</p>

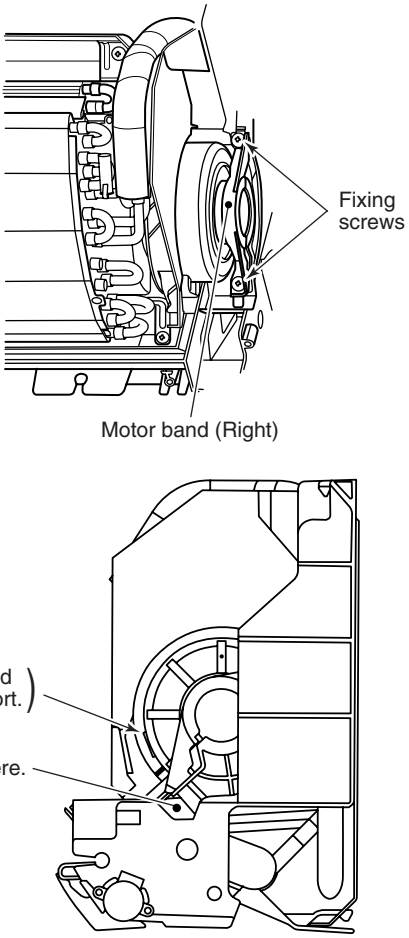
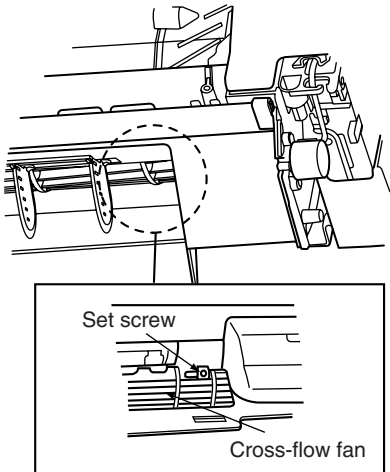
No.	Part name	Procedure	Remarks
⑦	Fan motor	<ol style="list-style-type: none"> 1) Perform work of item ②. 2) Perform work of item ④. 3) Loosen the set screw of the cross-flow fan from the discharge port. 4) Take off fixing screws (2 pcs) to remove the motor band (Right). 5) Pull out the fan motor outward. 	<p>Assemble the fan motor as shown below.</p>  <p>Drawing port of fan motor lead wires should be this position. (Determine the lead drawing port position so that motor band (Right) does not come to contact with fan motor drawing port.)</p> <p>Draw out fan motor lead wire from here.</p>
⑧	Cross-flow fan	<ol style="list-style-type: none"> 1) Perform works of items ② and ④. 2) Take off fixing screws (2 pcs.) at the left side of the end plate of the heat exchanger, and then take off fixing screws (2 pcs.) of the bearing base. 3) Make the left side of the heat exchanger float slightly, and then remove the bearing base. 4) Loosen set screw of the cross-flow fan from the discharge port. 5) Take off fixing screws (2 pcs.) to remove the motor band (Right). 	 <p>* Remove set screw from gap of thermal insulator.</p>

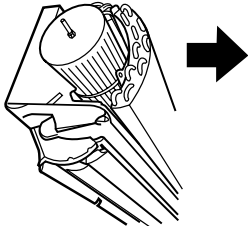
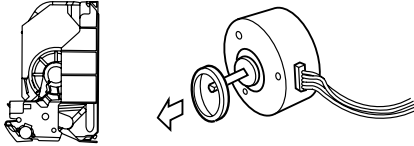
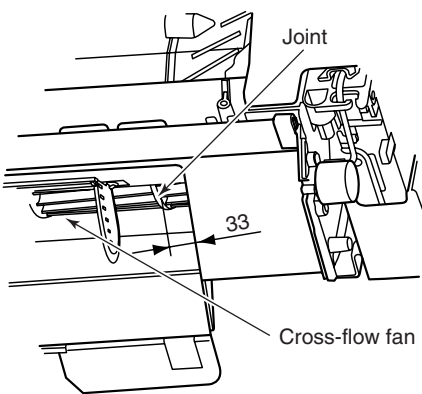
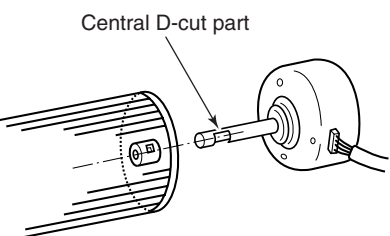
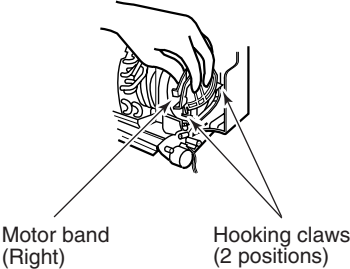
No.	Part name	Procedure	Remarks
⑧	Cross-flow fan	<p>6) Slide the fan motor rightward to remove it.</p> <p>7) Take off fixing screws (2 pcs.) from fixing support at right side of the heat exchanger.</p> <p>8) Lift up the left side of the heat exchanger toward you, and then remove the cross-flow fan.</p> <p><Caution to reassembling></p> <p>a) When assembling the bearing base, check the drain pipe is surely incorporated to the rear plate. (Otherwise water leak may be caused.)</p> <p>b) When assembling the fan motor, remove fan motor rubber (shaft center side), mount it in the position in the following figure, and then mount the fan motor.</p> <p>• Mount the cross-flow fan so that the right end of joint which is first one from right of the cross-flow fan is set at position 70.5mm apart from wall of the rear side of the main unit.</p> <p>• Mount the cross-flow fan so that D-cut part at the center comes to the mounting hole of set screw.</p> <p>• Determine the position of fan motor as shown in the figure for mounting. (Perform work of item ⑦.)</p> <p>c) When attaching motor band (Right), perform work of item b), set the hooking claws (2 positions) of the motor band (Right) in the main unit, and then perform reverse procedure of item 6).</p>	    

11. REPLACEMENT OF SERVICE INDOOR P.C. BOARD

Model type	P.C. board model
MMK-AP *** 4MH series	MCC-1510

[Requirement when replacing the service indoor P.C. board assembly]

In the non-volatile memory (hereinafter said EEPROM, IC10) installed on the indoor P.C. board before replacement, the type and capacity code exclusive to the corresponding model have been stored at shipment (AUTO/MANUAL) mode have been stored at installation.

Replace the service indoor P.C. board assembly according to the following procedure.

After replacement, make sure that the indoor unit address is set correctly and also the refrigerant cycle is working correctly by test operation.

<Replacement procedure>

CASE 1

Before replacement, power of the indoor unit can be turned on and the setup data can be readout by the wired remote controller.

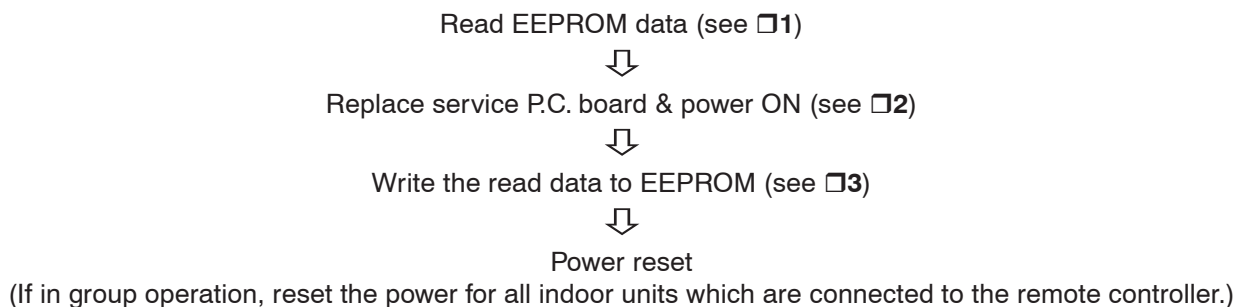



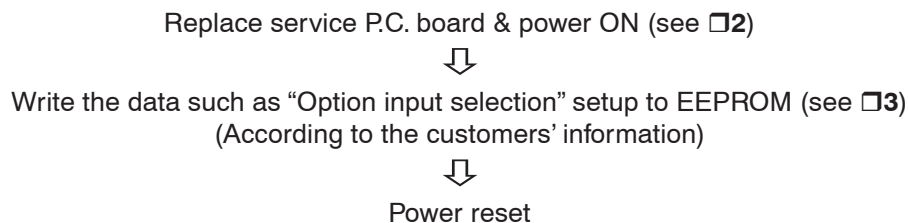

Case 2

Before replacement, the setup data can not be read out by the wired remote controller.



□1 Readout of the setup data from EEPROM

(Data in EEPROM contents, which have been changed at the local site, are read out together with data in EEPROM set at shipment from the factory.)

1. Push **SET**, **CL** and **TEST** button of the remote controller at the same time for 4 seconds or more. **1**
(Corresponded with No. in remote controller as shown below picture.)
 - When group operation, the header indoor unit address is displayed at the first time. In this time, the CODE No. (DN) **10** is displayed. The fan of the second indoor unit operates and the louver starts swinging if any.
2. Every pushing [Unit, Louver ] button, the indoor unit address in the group are displayed successively. **2**
Specify the indoor unit No. to be replaced.
3. Using the set temperature  /  buttons, the CODE No. (DN) can be moved up and down one by one. **3**
4. First change the CODE No. (DN) from **10** to **01**. (Setting of filter sign lighting time.)
Make a note of the set data displayed in this time.
5. Next change the CODE No. (DN) using the set temperature  /  buttons.
Also make a note of the set data.
6. Repeat item 5. and made a note of the important set data as shown in the below table.
 - **01** to **AA** are provided in the CODE No. (DN). On the way of operation, DN No. may skip.
7. After finishing making a note, push **TEST** button to return to the usual stop status. **4**
(Approx. 1 minute is required to be able to use the remote controller.)

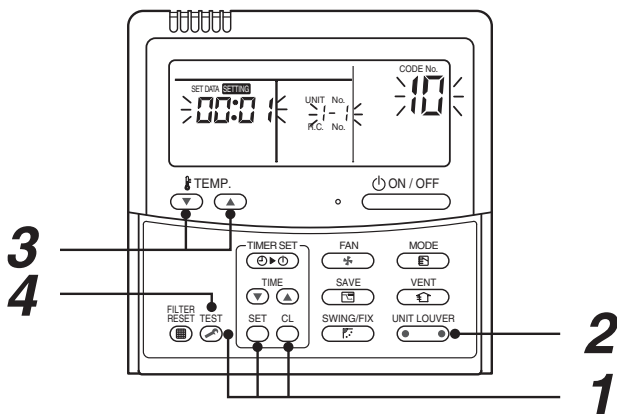

Minimum requirements or CODE No.

DN	Contents
11	Indoor unit capacity
12	Refrigerant line address
13	Indoor unit address
14	Group address

Capacity of the indoor unit is necessary to set the revolutions of the fan.

□2 Replacement of service P.C. board

1. Replace the P.C. board with a service P.C. board.
In this time, setting of jumper line (cut) or setting of DIP switch on the former P.C. board should be reflected on the service P.C. board.
Refer to the following table about DIP switch setting and drawing of P.C. board parts layout.
2. It is necessary to set indoor unit to be exchanged : Remote controller = 1 : 1
Based upon the system configuration, turn on power of the indoor unit with one of the following items.
 - 1) Single (Individual) operation
Turn on power of the indoor units and proceed to **□3**.
 - 2) Group operation
 - A) In case that power of the exchanged indoor unit only can be turned on.
Turn on power of the exchanged indoor unit only and proceed to **□3**.
 - B) In case that power of the indoor units cannot be turned on individually. (**CASE 1**)
 - a) Remove temperature the group wire connected to the terminal blocks A and B of the exchanged indoor unit
 - b) After connecting the remote controller wire only to the removed terminal block, turn on power of the indoor units and proceed to **□3**.
 - When the above methods cannot be used, follow at the **CASE 2** below.

C) In case that power of the indoor units cannot be turned in individually. **(CASE 2)**

- a) Remove all CN41 connectors of the indoor units in the same group except those of the exchanged indoor unit.
- b) Turn on power of the indoor units and proceed to **□3**.
 - After **□3** operation has finished, be sure to return the temporarily removed group wire or CN41 connector to the original connection.

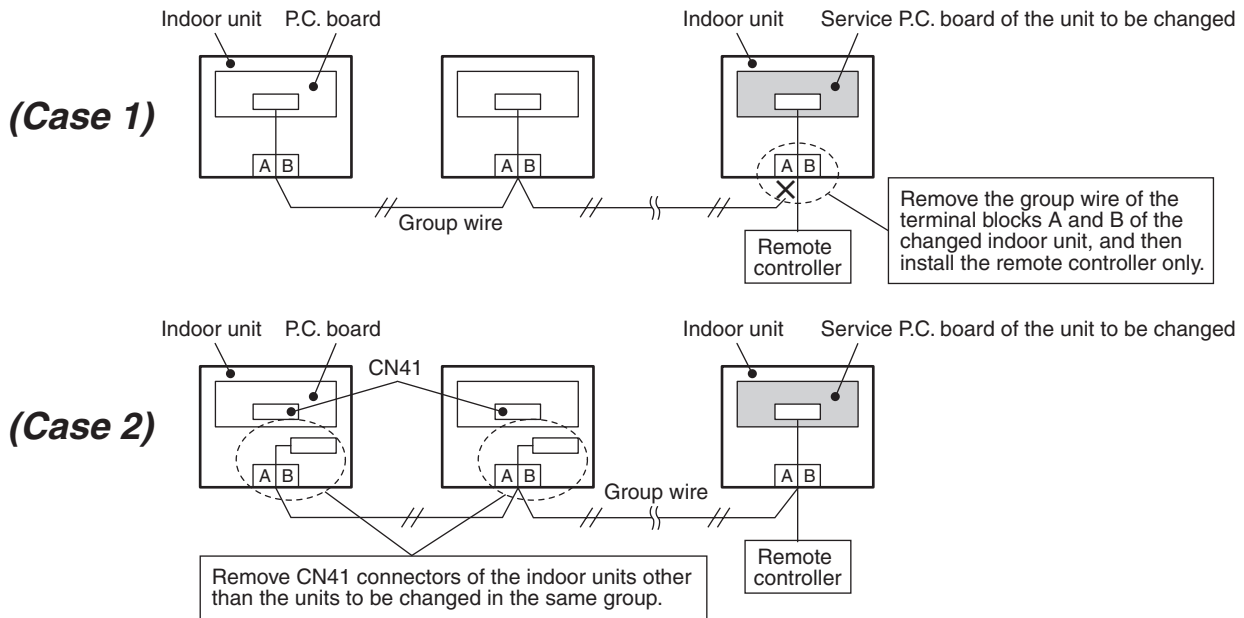

P.C. board parts layout drawing

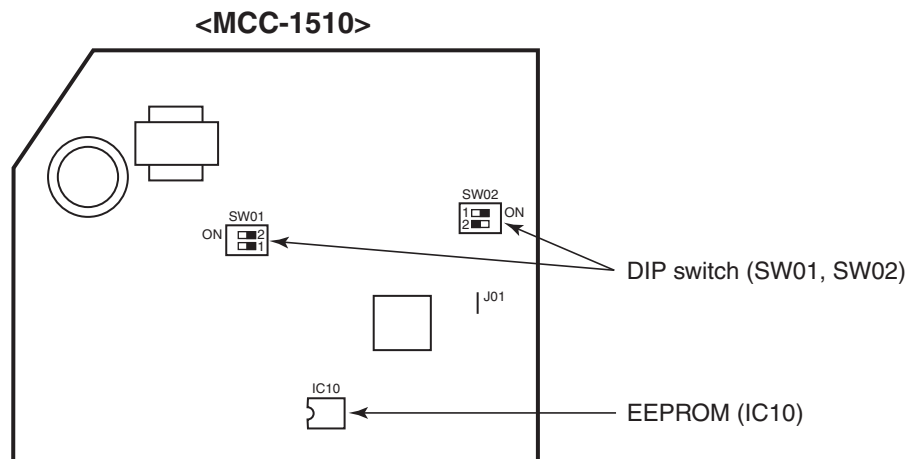





















Method of DIP switch setting

		Selected content	MMK-AP *** 4MH series	At shipment
SW01	Bit 1	Terminator resistor (for central control)	*1	OFF (Without terminator)
	Bit 2	Remote controller A/B selection	*1	OFF (A selection)
SW02	Bit 1	Custom / Multi model selection	ON	ON (Multi model)
	Bit 2	No use	OFF	OFF

*1 : Match to set up contents of P.C. board before replacement.

□3 Writing of the setup contents to EEPROM

(The contents of EEPROM installed on the service P.C. board have been set up at shipment from the factory.)

1. Push ,  and  button of the remote controller at the same time for 4 seconds or more. **1**
(Corresponded with No. in remote controller as shown below picture.) (The UNIT No. *ALL* is displayed.)
In this time, the CODE No. (DN) *10* is displayed.
The fan of the indoor unit operates and the louver starts swinging if any.
2. Using the set temperature  /  buttons, the CODE No. (DN) can be moved up and down one by one. **2**
3. First set the capacity of the indoor unit.
(Setting the capacity writes the data at shipment from the factory in EEPROM.)
 - 1) Using the set temperature  /  buttons, set *11* to the CODE No. (DN). **2**
 - 2) Using the timer time  /  buttons, set the capacity. **3**
(For example, 0005 for MMK-AP0124MH). Refer to the attached table.
 - 3) Push  button. (OK when the display goes on.) **4**
 - 4) Push  button to return to usual stop status. **5**
(Approx. 1 minute is required to start handling of the remote controller.)
4. Next write the contents that have been written at the installation such as the address data into EEPROM.
Repeat the above procedure 1.
5. Using the set temperature  /  button, set *01* to the CODE No. (DN). **2**
(Setup of lighting time of filter sign.)
6. The contents of the displayed setup data in this time should be agreed with the contents in the previous memorandum in □1.
 - 1) If data disagree, change the displayed setup data to that in the previous memorandum by the timer time  /  buttons, and then push  button. (OK when the display goes on.)
 - 2) There is nothing to do when data agrees.
7. Using the set temperature  /  buttons, change the CODE No. (DN).
As same as the above 6., check the contents of the setup data and then change them to data contents in the previous memorandum in □1.
8. Then repeat the procedure 6. and 7.
9. After completion of setup, push  button to return the status to the usual stop status. **5**
In a group operation, turn off the power supply once, return the group wires between indoor units and CN41 connectors as before, and then turn on power of all the indoor units.
(Approx. 1 minute is required to be able to use of the remote controller.)
 - *01* to *AA* are provided in the CODE No. (DN). On the way of operation, DN No. may skip.
When data has been changes by mistake and  button has been pushed, the data can be returned to the data before change by pushing  button if the CODE No. (DN) was not yet changed.

CODE No. table (Please record the objective unit data at field)

DN	Item	Memo	At shipment
01	Filter sign lighting time		0001: 150 hour
02	Dirty state of filter		0000: Standard
03	Central control address		0099: Unfixed
06	Heating suction temp. shift		0002: +2°C
0C	PRE-DEF indication selection		0000: Standard
0d	Cooling auto mode existence		0001: No auto mode cooling/heating
0F	Cooling only		0000: Heat pump
			Automatic selection by connected outdoor unit
10	Type	Be sure to set as 0008	0008: High wall type
11	Indoor unit capacity (See below table)		According to capacity type
12	Refrigerant line address		0099: Unfixed
13	Indoor unit address		0099: Unfixed
14	Group address		0099: Unfixed
1E	Temp. difference of automatic cooling/heating selecting control points		0003: 3 deg (Ts ± 1.5)
28	Automatic restart from power cut		0000: None
2A	Option input selection (CN80)		0002: External emergency input
2b	Thermo. output selection (T10 ③)		0000: Thermo. ON
2E	Input selection (T10 ①)		0000: Operation input
32	Sensor selection		0000: Available
30	Timer set (Wired remote controller)		0000: Available
89	Louver selection of cooling		0000: Standard

Indoor unit capacity (CODE No. [11])

Setup data	Model
0001*	Invalid
0001	MMK-AP0074MH
0003	MMK-AP0094MH
0005	MMK-AP0124MH

* Initial value of EEPROM installed on the supplied service P.C. board.

12. EXPLODED VIEWS AND PARTS LIST

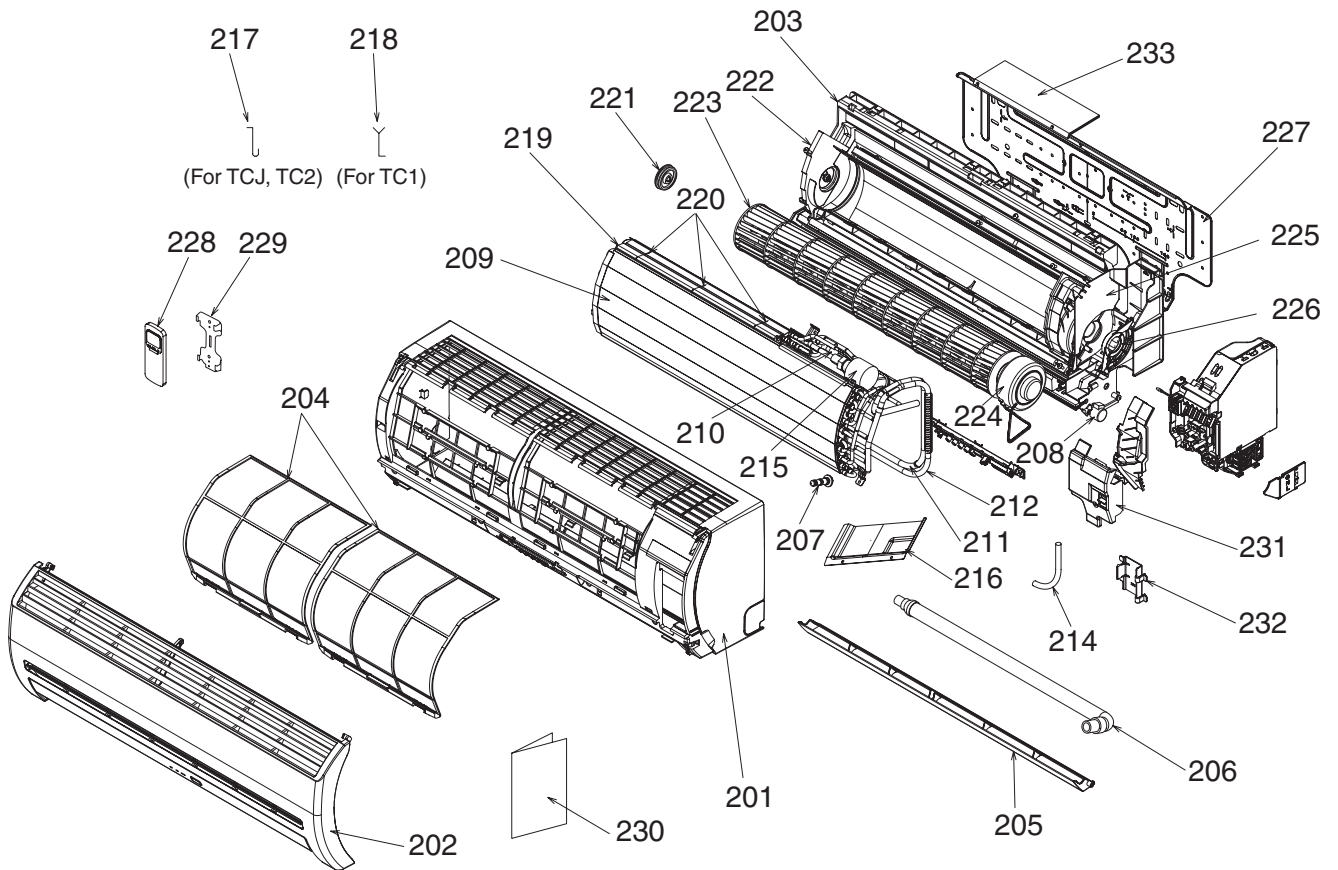

Location No	Part No.	Description	MMK-AP					
			0074MH-E	0094MH-E	0124MH-E	0074MH-TR	0094MH-TR	0124MH-TR
201	43T00421	FRONT PANEL ASSY	1	1	1	1	1	1
202	43T09370	SUCTION GRILLE	1	1	1	1	1	1
203	43T03326	BACK BODY ASSY	1	1	1	1	1	1
204	43T80301	AIR FILTER	2	2	2	2	2	2
205	43T09371	HORIZONTAL LOUVER	1	1	1	1	1	1
206	43T70001	DRAIN HOSE ASSY	1	1	1	1	1	1
207	43T79301	CAP-DRAIN	1	1	1	1	1	1
208	43T21372	MOTOR, STEPPING	1	1	1	1	1	1
209	43T44370	REFRIGERATION ASSEMBLY	1	1	1	1	1	1
210	43T44371	DISTRIBUTOR ASSEMBLY	1	1	1	1	1	1
211	43T47340	PIPE DELIVERY	1	1	1	1	1	1
212	43T47341	PIPE SUCTION	1	1	1	1	1	1
214	43T11301	PIPE SHIELD	1	1	1	1	1	1
215	43T21354	MOTOR PMV	1	1	1	1	1	1
216	43T49320	PLATE SHIELD	1	1	1	1	1	1
217	43T19322	FIX-P-SENSOR	2	2	2	2	2	2
218	43T19321	FIX-P-SENSOR	1	1	1	1	1	1
219	43T49317	RUBBER SEAL EVAPORATOR	1	1	1	1	1	1
220	43T49006	HOLDER FOR PLATE	3	3	3	3	3	3
221	43T22308	ASM-M-BEARING	1	1	1	1	1	1
222	43T39314	BASE BEARING ASSY	1	1	1	1	1	1
223	43T20322	ASSY CROSS FLOW FAN	1	1	1	1	1	1
224	43T21368	FAN MOTOR, MF-340-30-1R	1	1	1	1	1	1
225	43T39315	BAND MOTOR(LEFT)	1	1	1	1	1	1
226	43T39303	BAND MOTOR-R	1	1	1	1	1	1
227	43T82310	INSTALLATION PLATE	1	1	1	1	1	1
228	43T69309	WIRELESS REMOCON, WH-2UE	1	1	1	1	1	1
229	43T83003	HOLDER, REMOTE CONTROL	1	1	1	1	1	1
230	43T85497	OWNER'S MANUAL	1	1	1	1	1	1
231	43T62318	TERMINAL COVER	1	1	1	1	1	1
232	43T07303	HOLDER PIPE	1	1	1	1	1	1
233	43T62319	COVER PMV ASSEMBLY	1	1	1	1	1	1

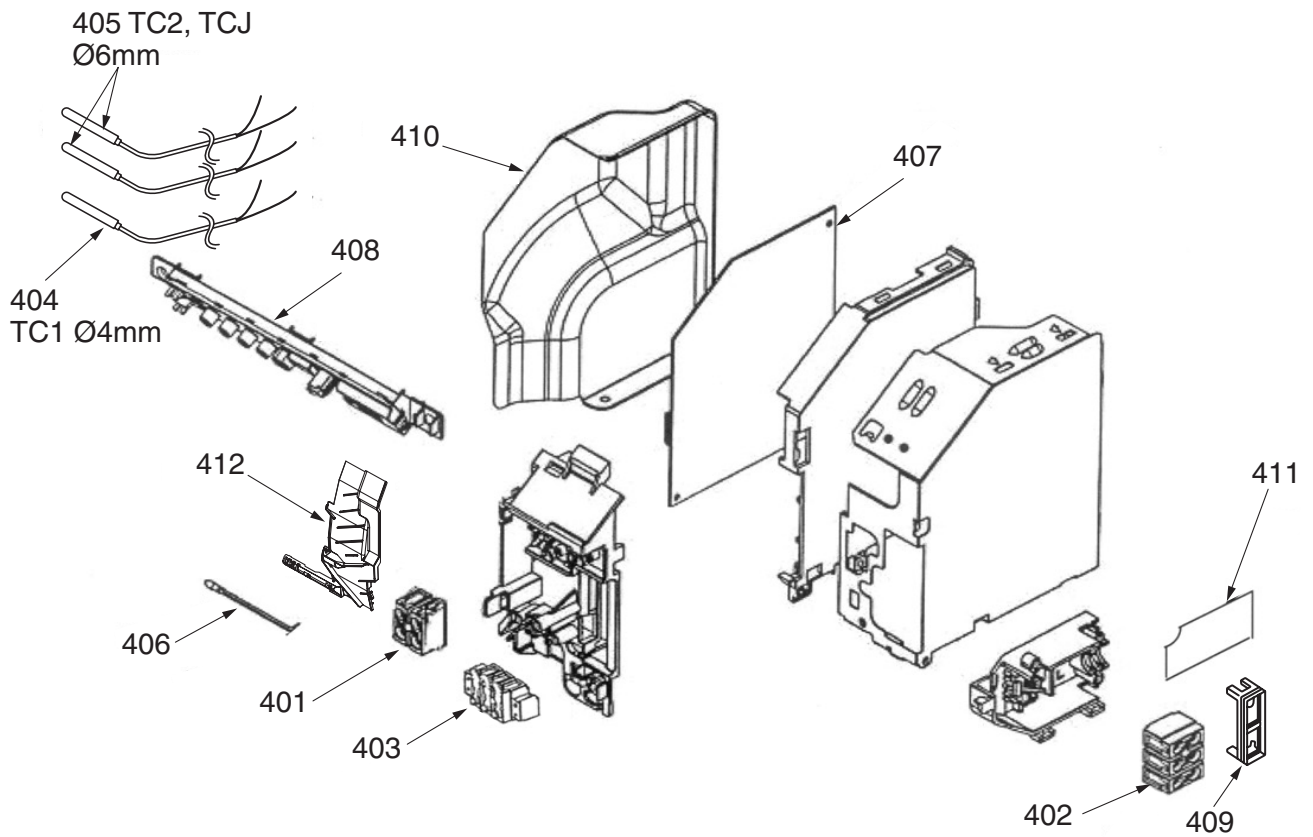

Location No	Part No.	Description	MMK-AP					
			0074MH-E	0094MH-E	0124MH-E	0074MH-TR	0094MH-TR	0124MH-TR
401	43T60001	TERMINAL 2P	1	1	1	1	1	1
402	43T60002	TERMINAL BLOCK 3P	1	1	1	1	1	1
403	43T60362	TERMINAL 4P	1	1	1	1	1	1
404	43T50317	SENSOR HEAT EXCHANGER, TC1	1	1	1	1	1	1
405	43T50304	SENSOR HEAT EXCHANGER	1	1	1	1	1	1
406	43T50313	SENSOR THERMOSTAT	1	1	1	1	1	1
407	43T69926	PCB BOARD, MCC-1510	1	1	1	1	1	1
408	43T69429	DISPLAY UNIT, MCC-861	1	1	1	1	1	1
409	43T62003	CORD CLAMP	2	2	2	2	2	2
410	43T61301	COVER-PARTS-E	1	1	1	1	1	1
411	43T62315	COVER-CONNECT-P	1	1	1	1	1	1
412	43T72307	DRAIN GUIDE	1	1	1	1	1	1

TOSHIBA CARRIER CORPORATION

23-17, TAKANAWA 3 CHOME, MINATOKU, TOKYO, 108-8580, JAPAN

Copyright © 1999 to 2010 TOSHIBA CARRIER CORPORATION, ALL Rights Reserved.