

eikon e5

# Service & Parts Manual



 **eikon**<sup>™</sup>



**CAUTION MICROWAVE EMISSIONS:  
DO NOT BECOME EXPOSED TO EMISSIONS FROM THE  
MICROWAVE GENERATOR OR PARTS CONDUCTING  
MICROWAVE ENERGY.**

# SYMBOLS

---

The symbols below are used, where applicable, as visual guidance throughout this manual.



## DANGER

This symbol is shown if there is a high risk of severe personal physical injury. The relevant safety precautions **MUST** be observed and implemented at all times.



## WARNING

This symbol is shown if there is a possible risk of personal physical injury or if damage may occur to the equipment. The relevant safety precautions **MUST** be observed and implemented at all times.



## INFORMATION

This symbol is used to highlight useful or important information. For example: The manual consists of main sections (tab markers on the extreme left and right of the pages), followed by the main subject heading, sub-headings and text. Text with a reference number or letter, such as (1) refers to the same reference **1** on the image.

# CONTENTS

## SAFETY & REGULATIONS

1 SAFETY REQUIREMENTS	4
1.1 Important:	4

## PRODUCT DETAILS

2 PRODUCT OVERVIEW & FUNCTIONS	5
3 MAIN FEATURES	6
4 TECHNICAL SPECIFICATIONS	7
4.1 Specifications	7
4.2 Serial Number (Rating Plate):	7

5 INSTALLATION	8
5.1 OVEN LOCATION AND POSITIONING	8

6 ELECTRICAL INSTALLATION	9
---------------------------	---

7 QUICK START GUIDE: QUICK SERVICE OVEN	10
---	----

7.1 START UP	10
7.2 USING A COOKING PROGRAM	11

8 OPERATING GUIDE: FULL SERVICE OVEN	12
--------------------------------------	----

8.1 easyToUCH MAIN MENU & KEYBOARD SCREEN	12
8.2 DEVELOPMENT MODE: CREATING A COOK PROGRAM	13

8.3 PRESS & GO	14
----------------	----

8.4 USING A COOKBOOK PROGRAM	14
------------------------------	----

8.5 CHANGING THE OVEN TEMPERATURE	15
-----------------------------------	----

8.6 VIEWING & EDITING PROGRAMS	15
--------------------------------	----

8.7 ADDING A NEW PROGRAM GROUP	16
--------------------------------	----

8.8 MOVE A PROGRAM WITHIN A PROGRAM GROUP	16
---	----

8.9 ADDING A PROGRAM TO A GROUP	17
---------------------------------	----

8.10 MANAGING PROGRAM GROUPS	17
------------------------------	----

9 OVEN CONTROL SETTINGS	18
-------------------------	----

9.1 Oven mode/navigation settings (A)	18
---------------------------------------	----

9.2 Language options (B)	18
--------------------------	----

9.3 Oven temperature settings and labels (C)	18
--	----

9.4 Recipe counters (E)	19
-------------------------	----

9.5 Date and Time settings (F)	19
--------------------------------	----

9.6 Sound levels (G)	19
----------------------	----

9.7 Oven Timer (H)	19
--------------------	----

9.8 USB oven programs (J)	20
---------------------------	----

9.9 Restore Factory Defaults (K)	20
----------------------------------	----

9.10 Temperature Band (L)	20
---------------------------	----

9.11 Change Password (M)	20
--------------------------	----

10 COOLING THE OVEN DOWN BEFORE CLEANING	21
--	----

10.1 Oven cool down	21
---------------------	----

10.2 Preparing to clean the oven	21
----------------------------------	----

11 Cold oven CLEANING INSTRUCTIONS	22
------------------------------------	----

## SERVICING

12 SERVICING THE OVEN	23
-----------------------	----

12.1 Servicing Procedure:	23
---------------------------	----

12.2 Enter Service mode:	23
--------------------------	----

13 ERRORS & DIAGNOSTICS	24
-------------------------	----

13.1 ERROR MESSAGES	24
---------------------	----

13.2 COPYING ERROR MESSAGES:	24
------------------------------	----

13.3 ERROR LOG	24
----------------	----

13.4 OVEN COUNTERS	24
--------------------	----

13.5 VISUAL VIEW	25
------------------	----

14 FIRMWARE UPDATES	26
---------------------	----

## TESTING COMPONENTS

15 OVEN TESTING	28
-----------------	----

15.1 Equipment required	28
-------------------------	----

15.2 Earth/Insulation Test:	28
-----------------------------	----

15.3 Screen calibration:	28
--------------------------	----

15.4 OVEN TESTS	29
-----------------	----

15.5 Microwave Power Test	29
---------------------------	----

15.6 Microwave Leakage Test	30
-----------------------------	----

15.7 Temperature Control Test	31
-------------------------------	----

15.8 Soak Test	32
----------------	----

15.9 Recommission Test	32
------------------------	----

16 HIGH VOLTAGE COMPONENTS	33
----------------------------	----

16.1 Power Transformer Test	33
-----------------------------	----

16.2 High Voltage Rectifier Test (Diode Board)	33
--	----

16.3 High Voltage Capacitor Test	34
----------------------------------	----

16.4 High Voltage Magnetron Test	34
----------------------------------	----

17 MAINS VOLTAGE COMPONENTS	35
-----------------------------	----

17.1 Door Interlock Adjustment	35
--------------------------------	----

## SPARES & REPLACEMENT

18 OVEN COMPONENTS	36
--------------------	----

19 SRB & BTS Circuit Boards	38
-----------------------------	----

19.1 SRB replacement	38
----------------------	----

19.2 BTS replacement	38
----------------------	----

19.3 PM (Personality Module) replacement	39
--	----

20 SPARE PARTS EXPLODED VIEW	40
------------------------------	----

21 SPARE PARTS	41
----------------	----

## FAULT FINDING

22 ERROR CODES DISPLAYED	43
--------------------------	----

## ELECTRICAL CIRCUITS

23 SRB & BTS Circuit Boards	45
-----------------------------	----

23.1 BTS LEDs	45
---------------	----

23.2 BTS Terminal Locations	45
-----------------------------	----

23.3 SRB LED's	46
----------------	----

23.4 SRB Terminal Locations:	47
------------------------------	----

24 CIRCUIT DIAGRAMS	48
---------------------	----

24.1 POWER CONNECTIONS e5	50
---------------------------	----

24.2 CONTROL CIRCUIT e5	51
-------------------------	----

24.3 HEATER CIRCUIT e5	52
------------------------	----

24.4 MICROWAVE CIRCUIT e5	53
---------------------------	----

## COMMISSIONING

25 Commissioning the oven	54
---------------------------	----

25.1 Initial installation	54
---------------------------	----

25.2 After Service	54
--------------------	----

# 1 SAFETY REQUIREMENTS

## 1.1 Important:

This manual provides technical guidance for engineers who have successfully undertaken a recognised product familiarisation and training course run by Merrychef to carry out service/repair tasks to the appliance/s shown on the front cover of this manual which must not be used for any other make or model of appliance.

Please remember that it is wiser not to attempt a service task if you are unsure of being able to complete it competently, quickly, and above all safely.

To avoid injury to yourself or others and to protect the appliance from possible damage, ensure you have read and understand all the relevant instructions and ALWAYS follow the Safety Codes when servicing an oven.

1.1.1 Before attempting to repair the oven, check the oven for microwave emissions using a calibrated microwave emission detector.

1.1.2 Check that the oven is not emitting microwaves, even when supposedly not in operation.

1.1.3 Check that the oven is not operating continuously, whether the display indicates cooking or not.

1.1.4 Never manipulate the mains power lead whilst it is live.

1.1.5 Before removing the oven casing ALWAYS isolate the oven from the mains electricity power supply; switch off and disconnect the oven plug from the wall socket, turn off isolator switch to disconnect fixed wired ovens. NOTE: The oven switch does not provide adequate protection against electric shock as it does not isolate all of the internal wiring from the mains.

1.1.6 The equipment must be locked-off to prevent the oven from being inadvertently powered up.

1.1.7 Do not leave the oven unattended without the oven panels fitted and keep within sight of other personnel when testing the oven, ensuring persons other than trained engineers are denied access.

1.1.8 The minimum number of panels should be removed and the HT capacitors must be discharged before working on the oven using a suitably insulated 10 MΩ Resistor.

1.1.9 Temporary insulation should be used to prevent accidental contact with dangerous conductors.

1.1.10 Do not touch any internal wiring within the Oven, whether you believe it is live or not and avoid touching the Metalwork (Casing, Panels, etc) of the Oven with your Body.

1.1.11 Only use electrically rated screwdrivers for adjusting 'Pots' etc., ensuring the tool touches nothing else.

1.1.12 Ensure the Test Equipment is set correctly before use.

1.1.13 Test equipment such as meter test leads or clamps must be fitted and removed whilst the unit is dead, for each and every test.

1.1.14 Do not undertake functional Magnetron testing with the oven panels removed.

1.1.15 Avoid touching the Test Equipment, unless necessary for the operation.

1.1.16 Upon completion of a service follow the steps for 'Commissioning the oven' under the Commissioning section of this manual.



**IF SMOKE IS OBSERVED:  
SWITCH OFF THE OVEN - DISCONNECT/ISOLATE FROM THE ELECTRICAL SUPPLY - KEEP THE OVEN DOOR CLOSED TO STIFLE ANY FLAMES.**



**DANGER:  
BEFORE REMOVING THE OVEN CASING, ISOLATE THE OVEN FROM THE MAINS ELECTRICITY POWER SUPPLY; SWITCH OFF, DISCONNECT OVEN PLUG FROM WALL SOCKET, TURN OFF ISOLATOR SWITCH TO DISCONNECT FIXED WIRED OVENS AND LOCK-OFF.**



**WARNING:  
ALWAYS DISCHARGE THE HT CAPACITORS BEFORE WORKING ON THE OVEN USING A SUITABLY INSULATED 10MΩ RESISTOR.**

## CAUTION

**WARNING TO SERVICE TECHNICIANS  
PRECAUTIONS TO BE OBSERVED BEFORE AND DURING SERVICING TO AVOID POSSIBLE EXPOSURE TO EXCESSIVE MICROWAVE ENERGY**

**1.1.17 Do not operate or allow the oven to be operated with the door open.**

**1.1.18 Make the following safety checks on all ovens to be serviced before activating the magnetron or other microwave source, and make repairs as necessary:**

- Interlock operation.
- Proper door closing.
- Seal and sealing surfaces (arcing, wear, and other damage).
- Damage to or loosening of hinges and latches.
- Evidence of dropping or abuse.

**1.1.19 Before turning on microwave power for any service test or inspection within the microwave generating compartments, check the magnetron, wave guide or transmission line, and cavity for proper alignment, integrity and connections.**

**1.1.20 Any defective or misadjusted components in the interlock, monitor, door seal, and microwave generation and transmission systems shall be repaired, replaced, or adjusted by procedures described in this manual before the oven is released to the owner.**

**1.1.21 A microwave leakage check to verify compliance with the Federal Performance Standard for the U.S.A. or the Canadian Regulation, HEALTH AND WELFARE, SOR/79 920 for Canada must be performed on each oven prior to release to the owner.**

## 2 PRODUCT OVERVIEW & FUNCTIONS

### CONSTRUCTION

Stainless Steel. cavity and casework.

### CONTROL SYSTEM

Colour touchscreen, icon driven.

Storage for up to 1024 programs with 6 stages per cooking program providing a user instruction for each stage.

USB memory stick data transfer.

Support for optional remote communications Ethernet module.

Safety system: ensures control area temperature is within limits.

### MICROWAVE POWER

Two magnetrons.

Distribution system, rotating passive antennae.

Microwave settings, off or 5-100% in 1% increments.

Safety system: agency approved monitored interlock door system, current monitoring and overheat detection for magnetrons.

### CONVECTED HEAT

Temperature settings 0°C off and from 100°C to 250°C in 1° C steps.

Distribution system, convection fan.

Safety system: oven cavity overheat detection.

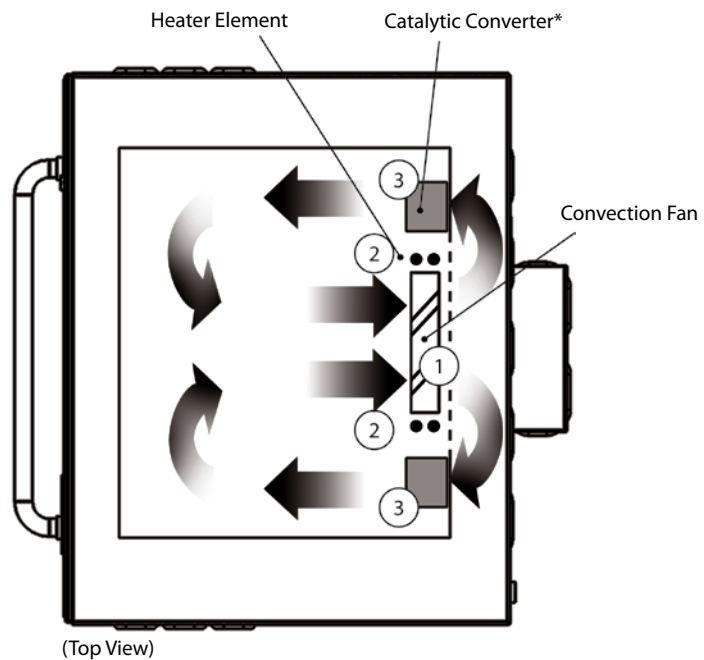

### Start up Sequence

With the oven switch in the OFF position and the mains power ON, the BTS & SRB boards boot up. When the oven switch is turned ON the splash screen briefly displays oven information and the cabinet cooling fan is activated.

After completing a successful logic test, the safety relay is energised and the oven preheats or displays a preheat temperature choice. Once preheated the oven displays the main menu if in FS mode or a recipe selection if in QSR mode.

### Shutting Down Sequence

When oven switch is turned OFF the screen displays 'Shutting Down' and the cooling fan operates until the cabinet temperature has been sufficiently reduced (cavity temperature of 50C).

The safety relay is de-energised and the BTS & SRB boards remain active.



### How it works:

The convection fan (1) draws air from the oven cavity, circulating it over the heating elements (2) to obtain the set temperature and through the catalytic converter (3)\* to clean the air before returning it to the oven cavity.

\* e5C models only.

## 3 MAIN FEATURES

### 1 ON/OFF SWITCH

ON (I) activates the oven, OFF (O) switches the oven to standby mode. IT DOES NOT ISOLATE INTERNAL WIRING FROM THE MAINS SUPPLY.

### 2 CONTROL PANEL

Touch sensitive controls (easyToUCH) for controlling oven functions, including diagnostics and service mode.

### 3 USB menuKey

A socket, located under the logo, allows a USB menuKey to be used to update the cooking programs and oven firmware on the pcb's.

### 4 OVEN CAVITY

The oven cavity is mostly constructed from stainless steel panels which must be kept clean to avoid contamination of food products and allow the oven to perform at peak efficiency.

### 5 SHELF SUPPORTS

Removable supports for oven shelves. They must be cleaned on a regular basis, and kept free of debris.

### 6 OVEN DOOR

The twin-skinned door has a thermally insulated inner section to lower the surface temperature and incorporates a microwave choke.

### 7 DOOR SEAL

Provides a tight seal around the door and must be kept clean. The seal must be checked regularly and replaced if worn or damaged.

### 8 AIR FILTER

The air intake provides cooling air for internal components and must be cleaned daily and must NOT be obstructed. The filter must be in place for the oven to function.

### 9 STEAM VENT

Vents steam from the oven cavity.

### 10 HOT AIR FAN

Circulates hot air through the catalytic converters (where fitted) and oven cavity.

### 11 RATING PLATE

The rating plate, located on the rear oven cover, states the Model, Serial Number, Electrical Ratings and Manufacturers telephone number.

### 12 MAINS ELECTRIC POWER CABLE

Located on the rear of the oven and must be replaced if worn or damaged.

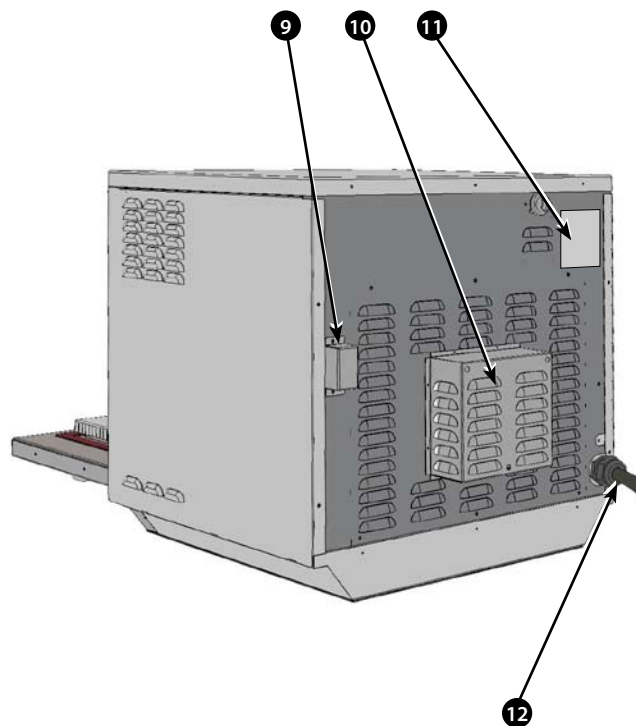
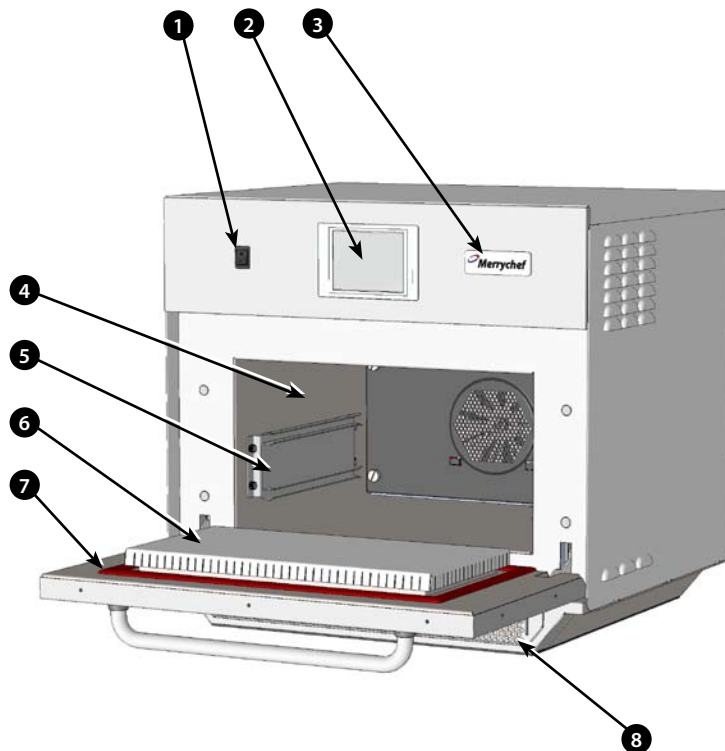

## 4 TECHNICAL SPECIFICATIONS

### 4.1 Specifications

Description	unit	e5
Touch screen controls	programs	1024
Ambient operating temperature	°C	<40
External HxWxD	mm	642x711x705
External HxWxD	inches	25.3x28.0x27.8
Internal HxWxD	mm	258.4x495x363.5
Internal HxWxD	inches	10.17x19.49x14.31
Cooking chamber	Ltr (cu.ins)	44.4 (2730)
Power output microwave	Watts	1400
Power output convection	kW	3.2
Power supply	Hz	50 & 60
Power supply	kW	6.2
Unpackaged oven weight nett	Kg (lbs)	94.0 (207)
Sound pressure level	dB(A)	<70
Stacking (with kit)	oven	0

### 4.2 Serial Number (Rating Plate):

Serial number: MM YY SITE SERIAL

i.e. 06 10 2070 12345 (1109207012345)

Oven manufactured in June 2010 at Sheffield (UK),  
production number 12345.

Model Number: MODEL CONVECTION MICROWAVE  
VOLTAGE HERTZ LEAD PLUG COMMUNICATION  
VERSION CUSTOMER/ACCESSORY COUNTRY

i.e. e4C 5V 08 6 D F U 1 GM US

(e4CSV086DFU1GMUS)

model e4C, 3200W, 1500W, 208V, 60Hz, 2P+GND  
(30A), moulded Hubbell plug, USB, 1, General  
Market, USA.

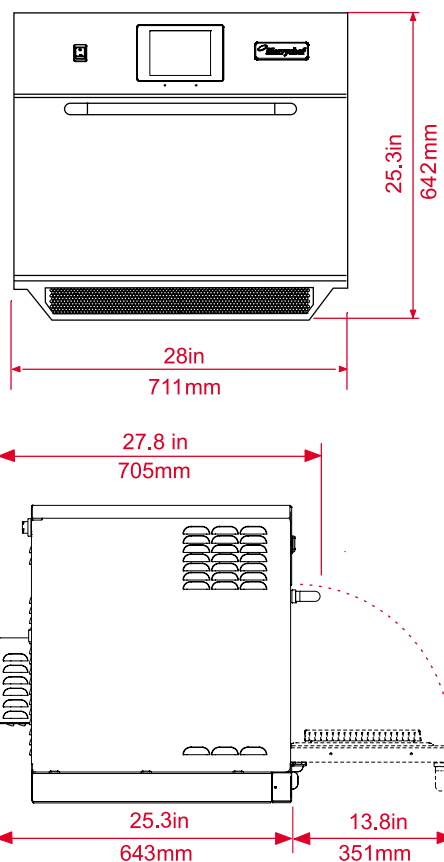

## 5 INSTALLATION

### 5.1 OVEN LOCATION AND POSITIONING

Choose a site away from major heat sources.

DO NOT position so that hot air is drawn in from fryers, grills, griddles, etc.

A heat barrier to the height of the oven must be installed if sited next to a burner, stove or range.

Place the oven on a permanent nonslip/nonflammable flat surface that is LEVEL, STABLE and STRONG enough for the oven and contents.

Allow a minimum clearance (A) of 2 inches (50mm) around the oven for hot air to escape.

Allow sufficient clearance (B), in front of the oven for the door to open fully.

The air intake is located at the lower front of the oven (1) and it is important that the airflow is as cool as possible and not preheated by other appliances such as burners, stoves, ranges, fryers, grills and griddles as this will deteriorate the life and performance of the oven.

Do not affix labels/stickers to oven other than those applied or approved by the manufacturer.

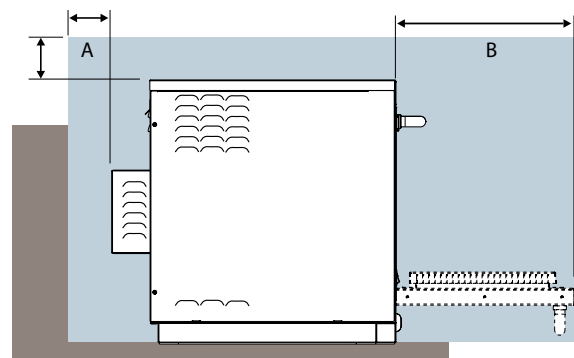
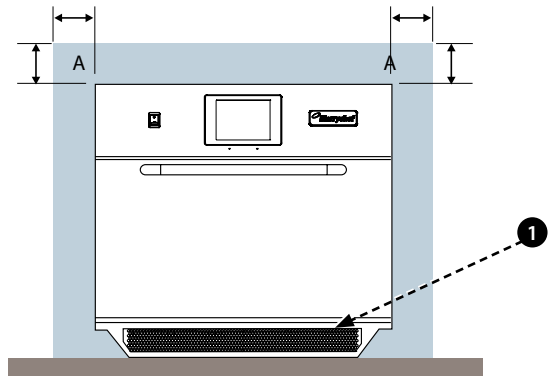

The oven will not operate without the AIR FILTER correctly fitted in place.

#### HANDLING & STORAGE:

When moving an oven always observe and follow National and local requirements for lifting and moving heavy objects. Do not use the oven door handle to lift oven.

When not in use, electrically disconnect the oven and store safely in a dry cool place, do not stack ovens.



## 6 ELECTRICAL INSTALLATION

**DANGER!**  
**THIS APPLIANCE MUST BE EARTHED. FAILURE TO DO SO MAY RESULT IN ELECTRIC SHOCK AND DEATH.**

### For all cord connected appliances:

#### GROUNDING INSTRUCTIONS

This appliance must be grounded. In the event of an electrical short circuit, grounding reduces the risk of electric shock by providing an escape wire for the electric current. This appliance is equipped with a cord having a grounding wire with a grounding plug. The plug must be plugged into an outlet that is properly installed and grounded.

**WARNING** - Improper use of the grounding can result in the risk of electric shock.

Consult a qualified electrician or Serviceman if the grounding instructions are not completely understood or if doubt exists as to whether the appliance is properly grounded.

Do not use an extension cord. If the power supply cord is too short, have a qualified electrician or serviceman install an outlet near the appliance.

### For a permanently connected appliance:

#### GROUNDING INSTRUCTIONS

This appliance must be connected to a grounded, metallic, permanent wiring system, or an equipment grounding conductor should be run with the circuit conductors and connected to the equipment grounding terminal or lead on the appliance.

#### IN CASE OF RADIO OR TELEVISION INTERFERENCE

This equipment generates and uses radio frequency energy and if not installed and operated correctly, in strict accordance with the manufacturer's instructions, may cause harmful interference to authorized radio communication services.

This product complies with the relevant requirements of CFR 47 Ch.1 Part 18, which are designed to provide reasonable protection against such interference. However, there is no guarantee that interference will not occur in a particular installation. If this equipment does cause interference to radio or television reception, which can be determined by turning the equipment off and on, the user is encouraged to try and correct the interference by one or more of the following measures:

- 1) Re-orientate the receiving antenna.
- 2) Relocate the microwave with respect to the receiver.
- 3) Plug the microwave into a different outlet so that the receiver and microwave are on different branch circuits.

If necessary the user should consult the dealer or an experienced radio/television technician for additional suggestions.

**Note:** Modifications should only be carried out by the manufacturer or authorized representative to ensure continuing conformance.

This device complies with Part 18 of the FCC rules.

# 7 QUICK START GUIDE: QUICK SERVICE OVEN

The easyToUCH screen display, layout and icons shown herein, are for guidance purposes only and are not intended to be an exact representation of those supplied with the oven.

## 7.1 START UP

1. Switch the oven on;  
Make all the relevant safety checks and ensure the oven is clean and empty before pressing the oven switch down to activate the oven.
2. The easyToUCH screen illuminates with the display briefly showing the serial number and oven data. Lightly tap the screen once to freeze the display, tap again to continue.
3. When the oven is setup with two or more preheating temperatures a choice is displayed. Scroll arrows at the bottom of the screen indicates there are more temperature choices not shown on screen, if necessary, use the scroll arrows, then select the temperature required to start preheating the oven.
4. During preheating the display shows the progress as the oven heats up to the set temperature. (To stop the oven heating touch the red 'X' symbol.)
5. The oven is ready to use when the 'COOKBOOK' is displayed.

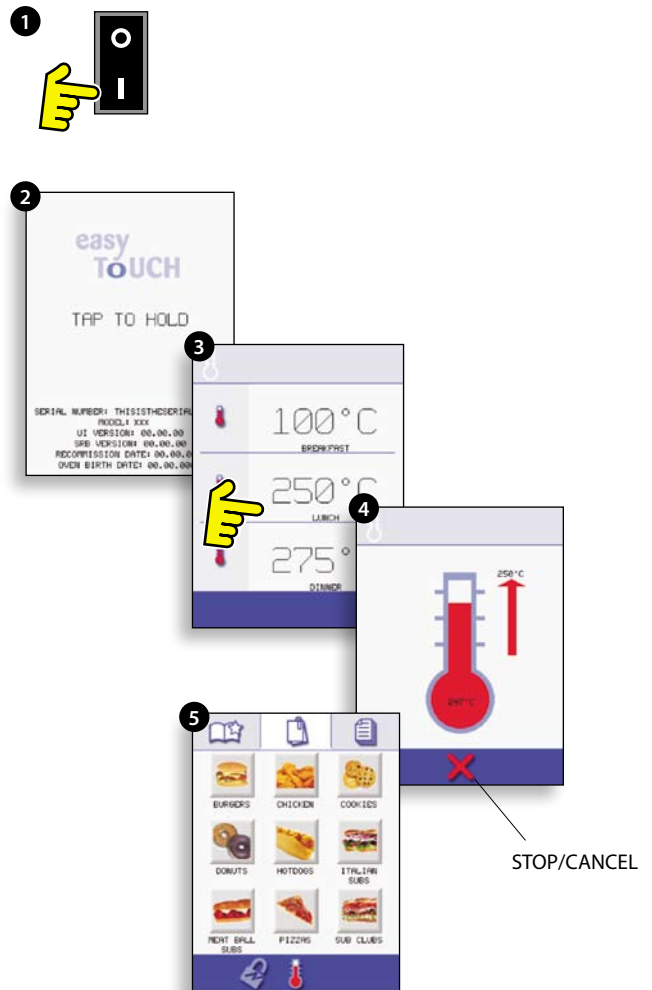

## COOKBOOK DISPLAY

DISPLAYS ALL COOKING PROGRAMS (Optional)  
SHOWS PROGRAM GROUPS  
FAVOURITES (Optional)

PROGRAM GROUP  
Each group contains a collection of cooking programs.

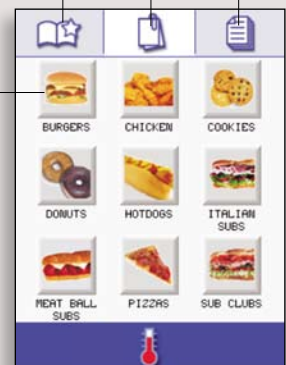

CHANGE OVEN TEMPERATURE (Optional)

## 7.2 USING A COOKING PROGRAM



Taking all the necessary precautions to ensure you do not burn yourself, open the oven door to place the food into the hot oven and close the door.

1. Select a program group, for example, 'BURGERS' to display the individual cooking programs.
2. Select a cook program to start, for example, 2 BURGERS.
3. Follow instructions if displayed on the screen.
4. Touch the green tick to cook.

The cooking time counts down for each program stage.

5. When the program ends a red bar is displayed usually with an audible sound - open the door or touch the red 'X' to return to the cook program.

*Note; opening the oven door during cooking stops the cooking program and displays a warning. Closing the door allows the user to continue or cancel the cooking program.*

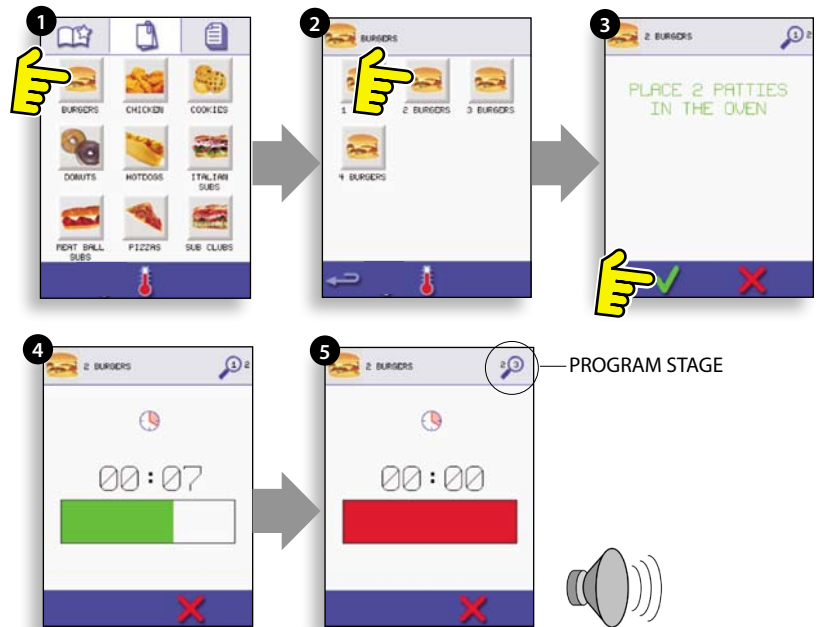

### AIR FILTER

#### IMPORTANT:

Clean the AIR FILTER (6) in the base of the oven every day and ensure that the air filter is in place prior to operating the oven. See 'CLEANING & MAINTENANCE'.



# 8 OPERATING GUIDE: FULL SERVICE OVEN

## 8.1 easyToUCH MAIN MENU & KEYBOARD SCREEN

MAIN MENU SCREEN:

1. DEVELOPMENT MODE enables multistage cooking programs to be developed, then stored under a name and symbol for reuse.
2. PRESS & GO allows quick access to use the cooking programs that are already stored.
3. COOKBOOK contains the oven's cooking programs. It displays Favourites, Cooking Program Groups and a complete listing of all cooking programs available.
4. CLEANING/TEMP CHANGE allows the oven temperature to be changed and the oven to be prepared for cleaning with reminders displayed to assist during the cleaning process.
5. SETTINGS are used to control the oven settings and functions including time and language, loading cooking programs and for service and maintenance purposes.
6. KEYBOARD SCREEN is used to enter an authorised password to enter data for programs and may restrict operator access to some functions.

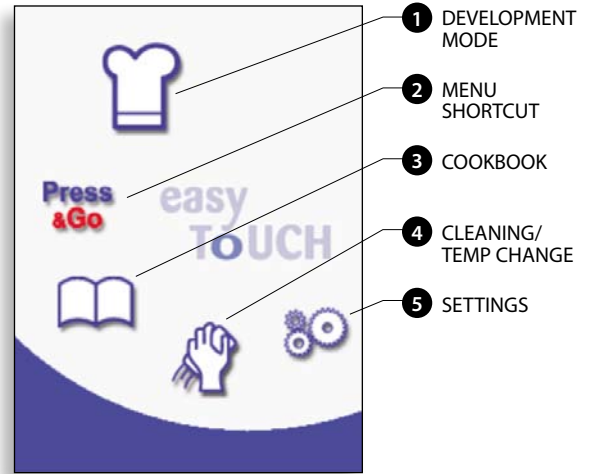

**i** For Program Names, Program Group Names and Passwords use 1-20 characters in 2 lines max.  
 For Stage instructions use 1-54 characters in 5 lines max.

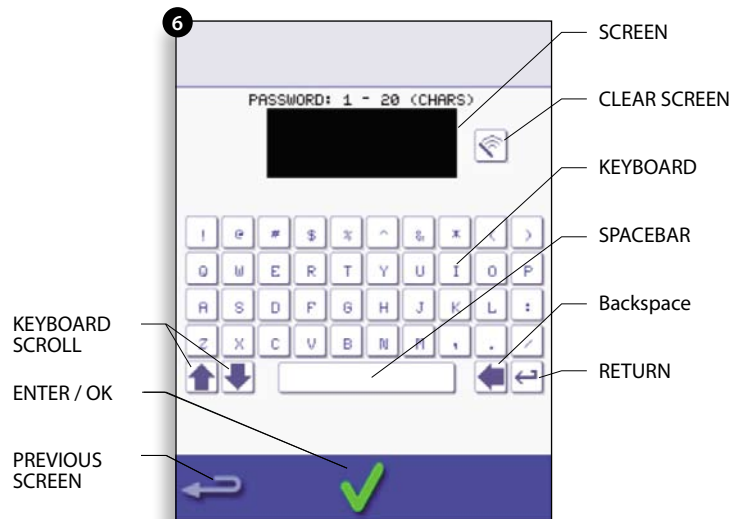

## 8.2 DEVELOPMENT MODE: CREATING A COOK PROGRAM

1. Select the 'chef's hat' symbol from the main menu to enter development mode.

### Enter stage 1 of the program

2. The temperature displays the set preheated oven temperature.

To increase or decrease the temperature required, select the temperature symbol (2), enter the temperature in the keypad within the limits displayed and select OK.

3. Select and set the cooking time up to a maximum of 10 minutes.

For example: Enter 110 (1minute and 10 seconds).

4. Select and set the Microwave Power [0, 5-100%]

5. Select and set a Fan speed (if available) within the limits shown.

6. Select the information icon to enter an instruction (Optional). The instruction appears in the display at the beginning of that stage.

For example: 'Stage 1 place product in the oven.'

### Enter stage 2 of the program (Optional).

7. Programs can have up to a maximum of 6 stages.

Repeat the steps 2-6 from stage 1 above.

### Running and saving the program

1. Select OK to confirm the Program.

**WARNING: ENSURE PRODUCT IS IN THE OVEN AND ALL SAFETY PRECAUTIONS ARE FOLLOWED BEFORE RUNNING THE PROGRAM.**

2. Run the program (optional).

If the results are not satisfactory, select the backspace, change the cooking settings and retest.

3. Select the save Cookbook symbol to record the program to the cookbook.

4. Select an image to represent the program.

(Use the scroll arrows for more pictures.)

5. Enter the name for the cooking program, using a maximum of 20 characters, for example, '1 BURGER'; then select OK to save the program to the Cookbook.

6. A symbol with a green tick on a book is displayed to indicate that the program has been successfully saved to the Cookbook.



Example below; setting the cooking time (step 3):

To Set the cooking Time select the Time symbol.

Enter the cooking time on the pad.

Select OK to accept the time.

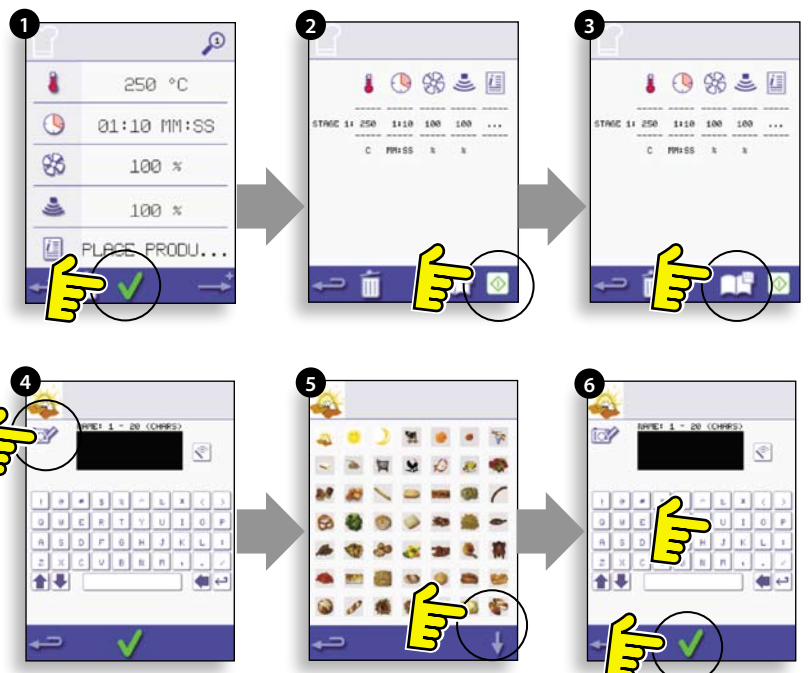
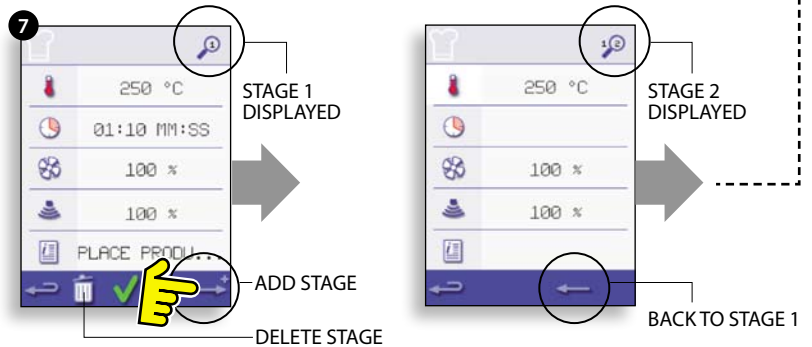
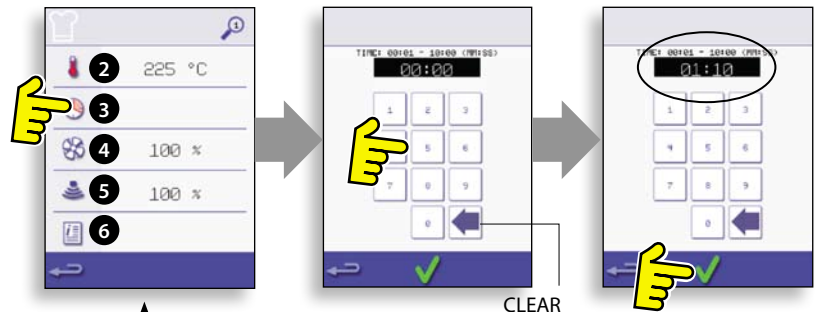

### 8.3 PRESS & GO

#### Running a cooking program from the Press & Go menu.

1. Select 'PRESS & GO' from the main menu screen.
2. Select the item required to cook.
3. The display shows the temperature, cooking time, microwave power and fan speed while the timer counts down. The timer bar turns red to indicate the cooking cycle has finished.

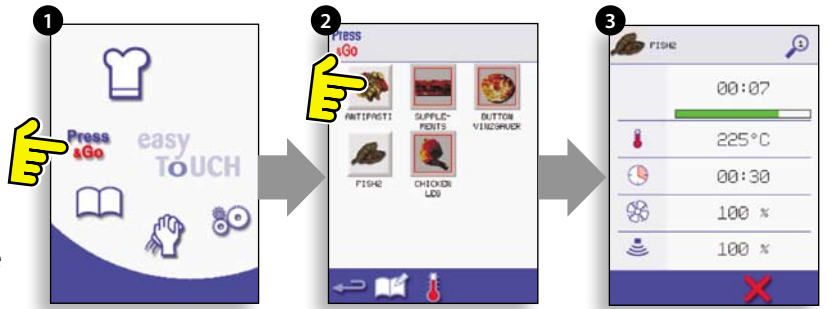

#### Choosing which cooking programs are shown in the 'PRESS & GO' menu screen.

1. After selecting 'PRESS & GO' from the main menu screen, select the EDIT symbol.
2. Two lists are displayed, the 'PRESS & GO' menu items are shown in the upper list and the lower list shows other menu items which are available. Both lists can be scrolled up or down using the arrows on the extreme right.
3. Select an item, then choose whether to change its order within the menu or to remove it into the lower list.
4. Select an item to move into the upper list, making it available in the 'PRESS & GO' menu.
5. Select backspace to return to the menu screen when finished.

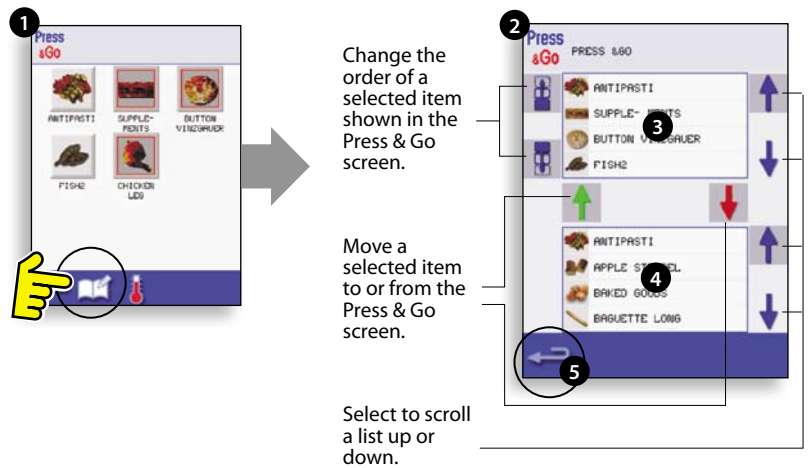

### 8.4 USING A COOKBOOK PROGRAM

To find the required Program in the cookbook.

**WARNING: ENSURE THERE IS FOOD PRODUCT IN THE OVEN BEFORE STARTING A COOKING PROGRAM.**

1. Select 'COOKBOOK' from the main menu screen.
  2. Select the ALL MENUS symbol.
  3. Use scroll up/down arrows to find the program.
- NOTE: if an image has a red line around it the oven temperature is set too high or too low for that recipe. See 'CHANGING THE OVEN TEMPERATURE'.
- Taking all the necessary precautions to ensure you do not burn yourself, place the food product into the hot oven cavity and close the door.

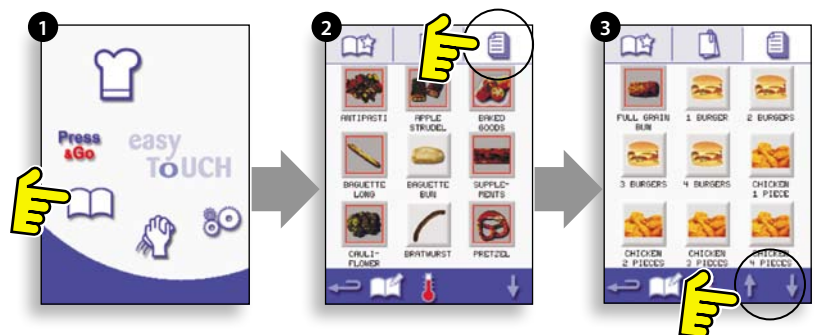

**WARNING: HOT SURFACE HAZARD**



4. Select the required cooking program to start cooking.

For example, '1 BURGER':

5. The program either starts immediately displaying a countdown timer, or an instruction is displayed first; follow the stage instruction then select OK to start cooking. If the oven door is not opened within 30 seconds a warning message appears.

6. The cooking timer counts down to zero and makes a sound to indicate an operator action is required at the end of a cooking stage or the end of a cooking program.

Once the cooking program has finished, opening the oven door to remove the food returns the display to the 'COOKBOOK' screen.

*Note; opening the oven door during cooking stops the cooking program and displays a warning. Closing the door allows the user to continue or cancel the cooking program.*

*To check the oven temperature when cooking, lightly tap the temperature displayed, the oven cavity temperature is shown with an asterisk.*

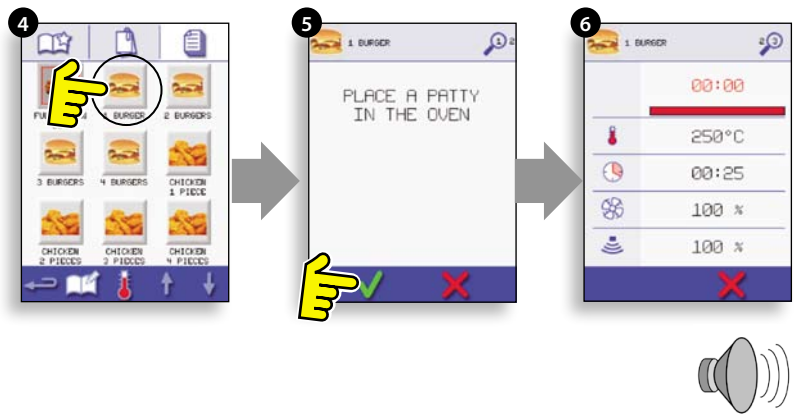

## 8.5 CHANGING THE OVEN TEMPERATURE

1. Take note of the temperature required for the recipe and select OK.

2. Select the temperature symbol.

3. An asterisk next to the number indicates the present oven temperature, select the required oven temperature for the recipe. Once the oven is at the required temperature continue from selecting the 'COOKBOOK' in step 1.

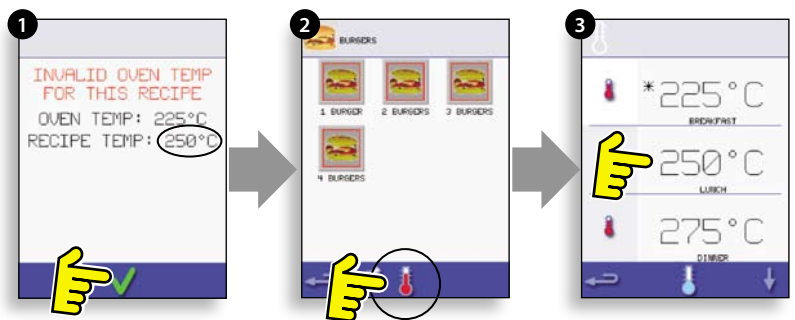

## 8.6 VIEWING & EDITING PROGRAMS

1. Select 'COOKBOOK' from the main menu screen.

2. Select the ALL MENUS symbol.

3. Select 'EDIT COOKBOOK'.

4. Use the up/down scroll arrows on the right side of the screen to find the cooking program, for example 1 BURGER and select the view/edit cooking program symbol.

5. View or adjust the program as required, see Development mode for details.

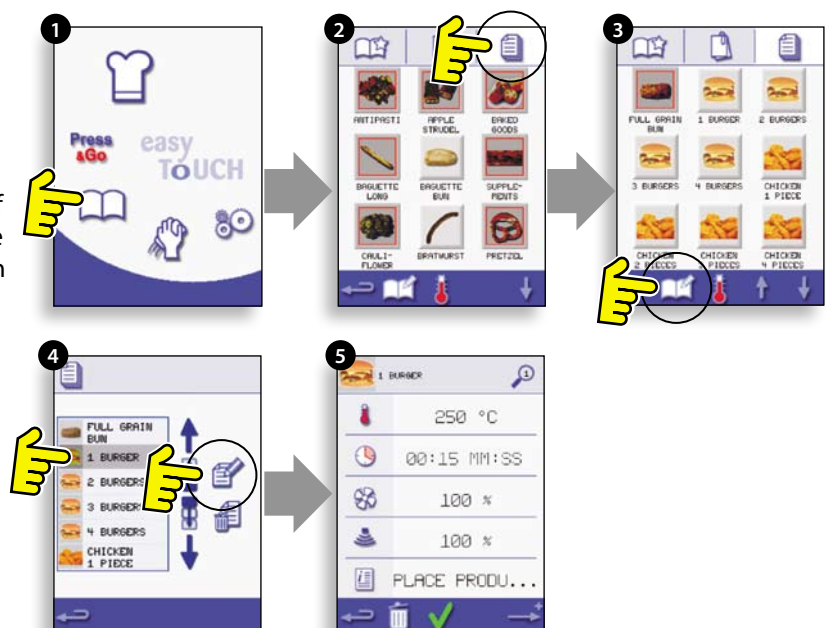

## 8.7 ADDING A NEW PROGRAM GROUP

To add a new Program Group.

1. Select 'COOKBOOK' from the main menu screen.
2. Select 'EDIT COOKBOOK'.
3. Select the 'ADD A NEW GROUP' symbol.
4. Enter a name for the new Program Group (max. 20 characters).
5. Select an image to represent the Group. (Use the scroll arrows for more pictures.)
6. Select OK to save the Program Group to the Cookbook.

Select backspace to return to the 'COOKBOOK'.

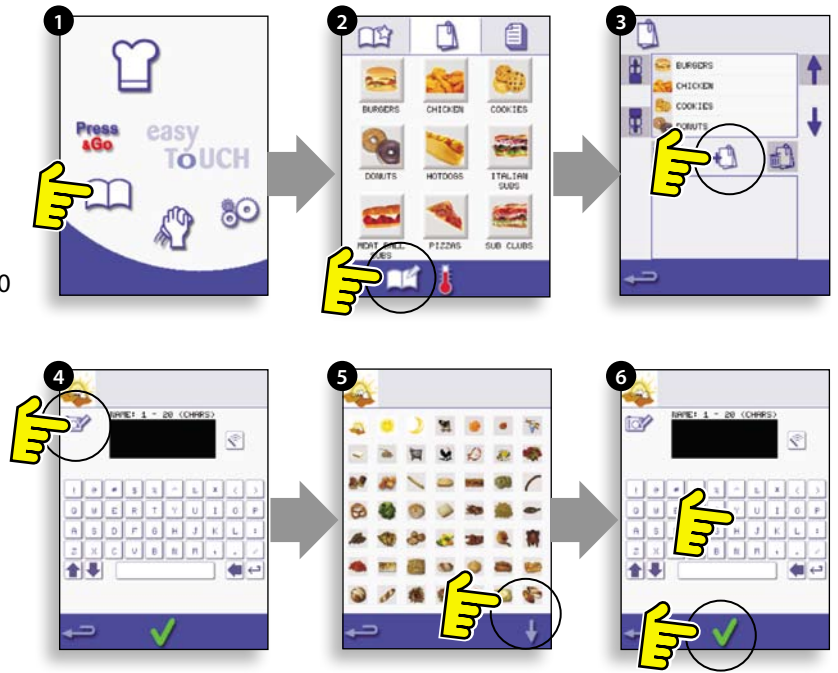

## 8.8 MOVE A PROGRAM WITHIN A PROGRAM GROUP

Example moving the position of the '4 BURGERS' cooking program within the program group called 'BURGERS'.

1. Select 'COOKBOOK' from the main menu screen.
  2. Select the 'BURGERS' program group.
  3. Select 'EDIT COOKBOOK'.
  4. Use the up/down scroll arrows on the right side of the upper part of the edit screen to view the cooking programs in the group.
- Then select the cooking program to be moved ('4 BURGERS') and use the up/down arrows on the left side of the upper screen to move the selected program within the program group.

Select backspace to return to the 'COOKBOOK' screen.

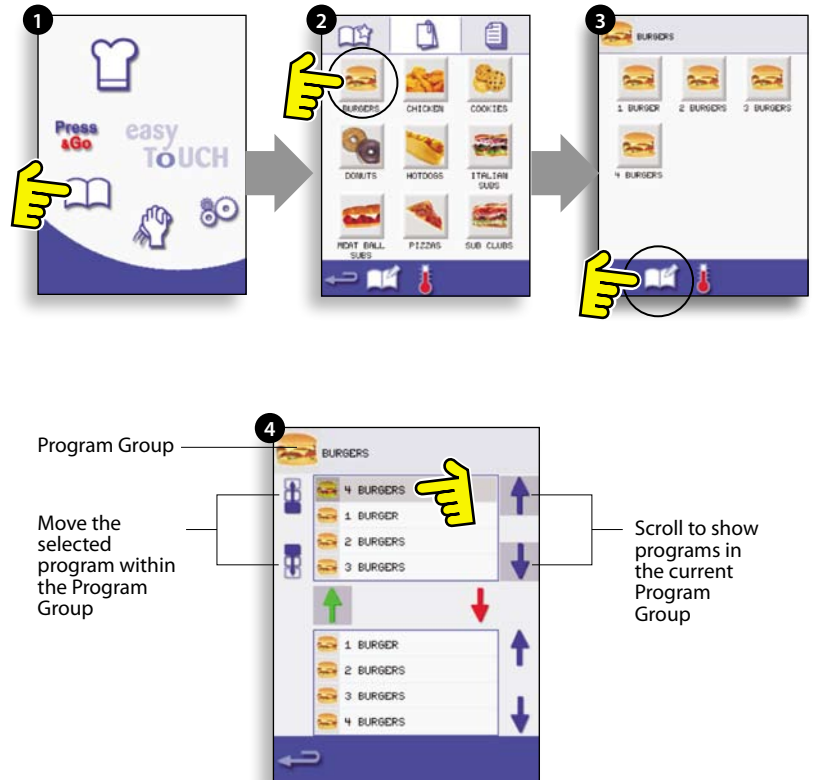

Program Group

Move the selected program within the Program Group

Scroll to show programs in the current Program Group



## 8.9 ADDING A PROGRAM TO A GROUP

To add a cooking program to an existing PROGRAM GROUP.

Example add Program '4 BURGERS' to the program group 'BURGERS'.

1. Select 'COOKBOOK' from the main menu screen.
2. Select the 'BURGERS' Program Group.
3. Select 'EDIT COOKBOOK'.
4. In the lower part of the screen use the up/down scroll arrows on the right side to find and select the '4 BURGERS' cooking program.
5. Select the green UP arrow to add the '4 BURGERS' cooking program to the Program Group in the upper part of the screen, then select backspace to return to the cooking programs.
6. Select backspace again to return to the 'COOKBOOK'.

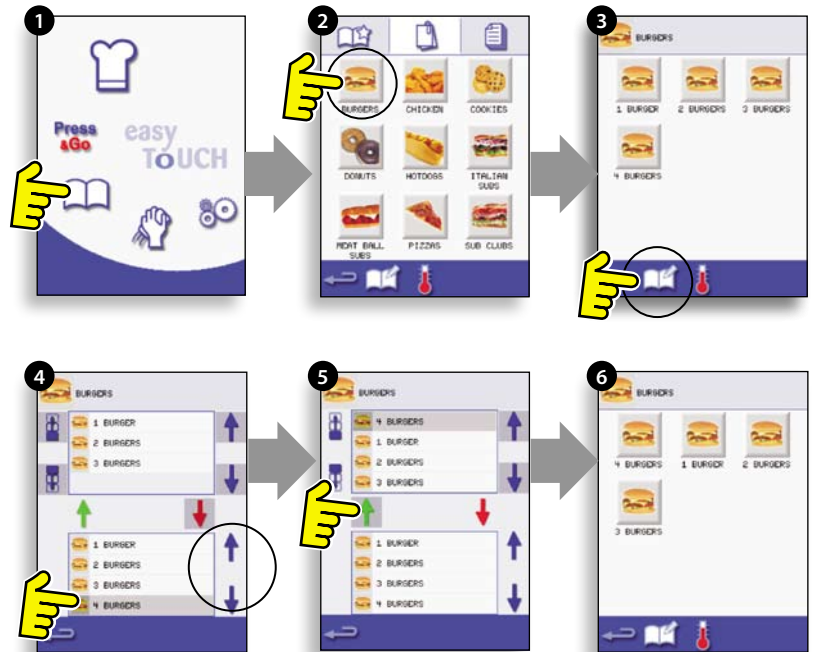

## 8.10 MANAGING PROGRAM GROUPS

To move a program position in a Program Group

1. Select 'COOKBOOK' from the main menu screen.
2. Select 'EDIT COOKBOOK'.
3. Use the scroll arrows, up and down on the right side of the screen to locate all the Program Groups.
4. Select the Program Group to be moved and use the up and down arrows, on the left side of the screen to move the selected program.
5. Select backspace to go back to the 'COOKBOOK'.



To change the Program Group name.

- Select the Program Group.
- Select EDIT PROGRAM GROUP.
- Enter the new name and select OK.

To delete a Program Group

- Select the Program Group.
- Select the DELETE Program Group symbol.
- Select OK to Delete the Group.

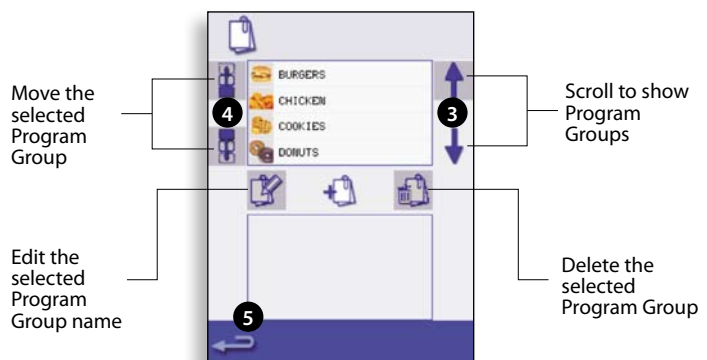

# 9 OVEN CONTROL SETTINGS

1. Select the 'settings' symbol from the main menu screen.

2. Enter the password and select OK to display the Settings menu (3) comprising:

- A. Oven mode/navigation settings.
- B. Language options.
- C. Oven temperature settings and labels.
- D. Service information and error logs (password required).
- E. Recipe counters.
- F. Date & time settings.
- G. Speaker sound levels.
- H. Oven Timer (Temperature/ON/OFF).
- J. USB program connection.
- K. Restore settings to Factory defaults.
- L. Temperature Band.
- M. Change Settings/Service access passwords.

When finished with a setting, select backspace to return to the main settings menu.

To exit the settings menu, select backspace, a prompt will be displayed to either 'SAVE' or 'DISCARD' any changed settings (4).

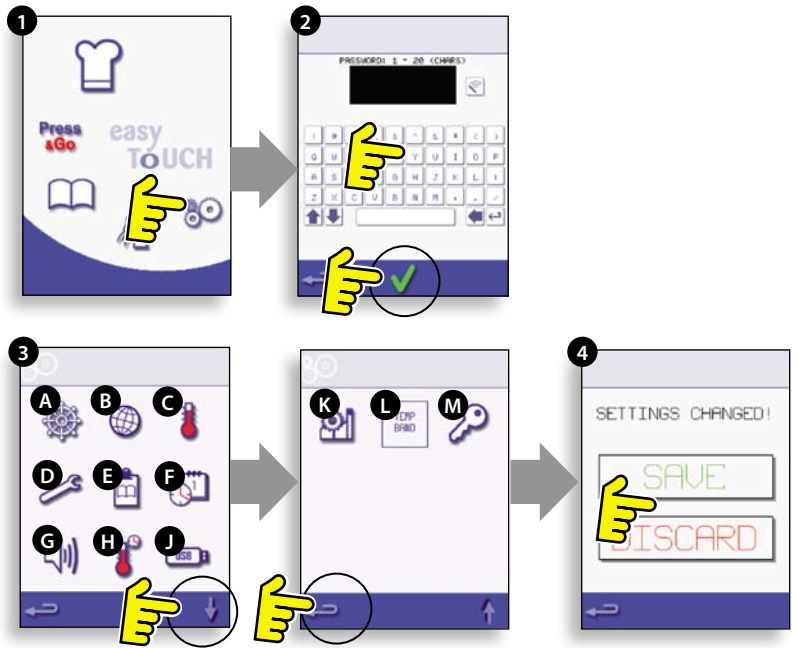

## 9.1 Oven mode/navigation settings (A)

9.1.1 Select the oven mode/navigation symbol (A) from the 'Settings' menu.

9.1.2 Select 'Quick Serve Mode' for cooking only, or 'Full Serve Mode' for cooking & development programs.

9.1.3 Select 'Enable Settings' to display an 'unlock' symbol on the Quick Serve Cookbook screen to allow access to the 'Settings' menu.

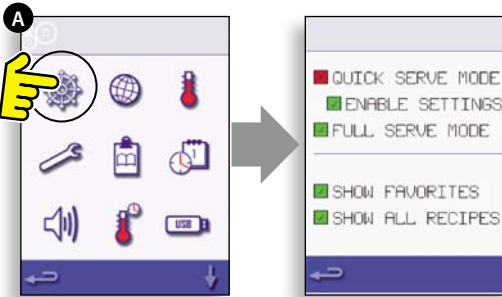

## 9.2 Language options (B)

9.2.1 Select the globe symbol (B).

9.2.2 Select the checkbox of the required language from the list shown.

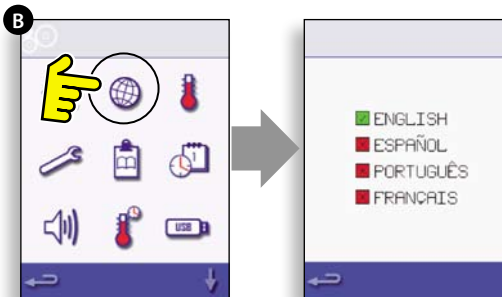

## 9.3 Oven temperature settings and labels (C)

9.3.1 To change the oven preheat temperature, select the temperature symbol (C) to display the keypad, enter the required temperature and select OK.

9.3.2 Note, the temperature options screen is only displayed at start up when two or more temperatures are set above minimum.

9.3.3 To change a temperature label, select the label to display the keyboard, enter the required label name and select OK.

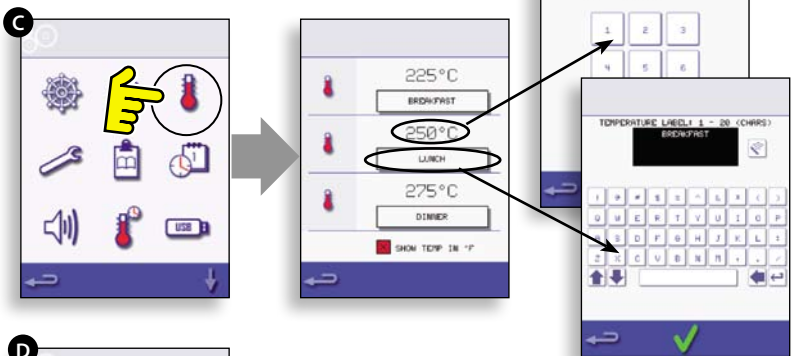

**For Service information & error logs (D) refer to Servicing.**



## 9.4 Recipe counters (E)

9.4.1 Select the clipboard symbol to display a listing of recipe counters.

9.4.2 If shown, use the arrows (bottom right) to scroll up and down the list.



## 9.5 Date and Time settings (F)

9.5.1 Select the time/date symbol to display the setting options.

9.5.2 CHANGE THE DATE: Select 'MONTH', enter the correct Month on the keypad and select OK.

9.5.3 Select 'DAY', enter the correct Day on the keypad and select OK.

9.5.4 Select 'YEAR'; enter the correct last two digits of the Year on the keypad and select OK.

9.5.5 To display the Month first, followed by the Day and Year, select the 'MM-DD-YY' checkbox. Note; the Error Logs are recorded using these settings.

9.5.6 CHANGE THE TIME: Select 'HOUR', enter the correct Hour on the keypad and select OK.

9.5.7 Select 'MIN', enter the correct Minutes on the keypad and select OK.

9.5.8 Select the 'AM' or 'PM' checkbox for a 12 Hour clock or select '24' for a 24 Hour clock.

9.5.9 Select the day name shown to cycle through to display the correct weekday.

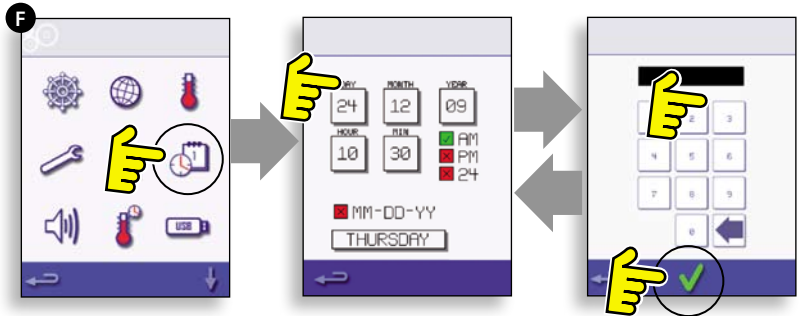

## 9.6 Sound levels (G)

9.6.1 Select the speaker symbol to display the volume levels.

9.6.2 Select a sound level suitable for the environment from none (OFF) to the loudest (100%).

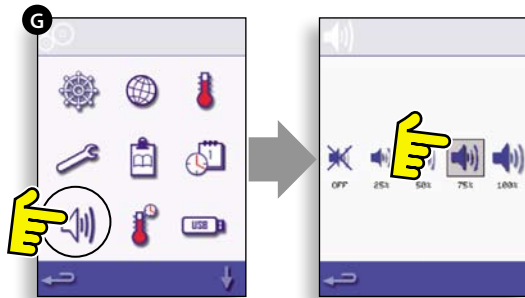

## 9.7 Oven Timer (H)

9.7.1 Select the thermometer/timer symbol.

9.7.2 Select the 'Timer Enabled' checkbox (green tick).

9.7.3 Select a weekday using the up/down arrows.

9.7.4 Select an empty 'Time' box (maximum of 5 per day) or clear the box using the wipe symbol.

9.7.5 Enter the start time on the keypad and select OK.

9.7.6 Select an empty 'Temperature' box opposite the Time box displaying the time just entered, or clear the box using the wipe symbol next to it.

9.7.7 Enter the cavity temperature required on the keypad and select OK. Note; you can also select zero to turn the heat off. Selecting the red circle symbol will switch the oven OFF.

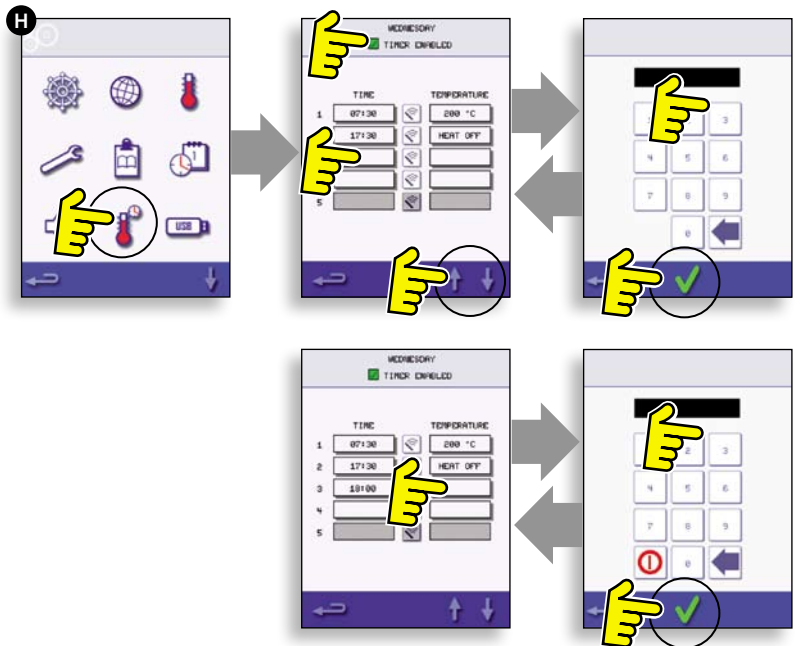

### 9.8 USB oven programs (J)

**IMPORTANT: Downloading from a USB will clear all the existing programs.**

Check that the key has the correct number/code for the programs you want to load into the oven memory.

- 9.8.1 Select USB from the settings screen.
- 9.8.2 Slide the USB cover (logo on the oven front) upwards to insert the USB into the slot.
- 9.8.3 When the inserted USB stick has finished flashing, select the required USB symbol, for example; RECIPES.
- 9.8.4 Select the new file using the scroll arrows if required to locate the file. Note; a tinted band over a file name indicates the file is not available to use.
- 9.8.5 Double check the file is correct before selecting OK, if not, select 'X' and locate the correct file.
- 9.8.6 Progress of the file update is displayed. Once completed the oven restarts and commences heating up to the PREHEAT temperature ready to cook.
- 9.8.7 Remove the USB and keep in a safe place. Reposition the USB cover.

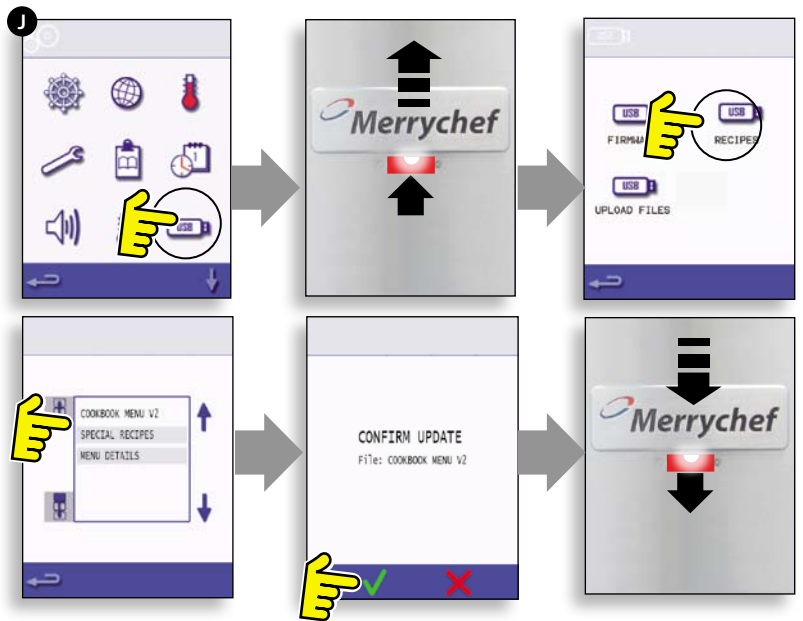

### 9.9 Restore Factory Defaults (K)

- 9.9.1 Select the factory symbol to replace the existing oven settings with the original factory default settings. Note; this action cannot be undone.
- 9.9.2 Select OK, or select the red cross to cancel and keep the existing settings.

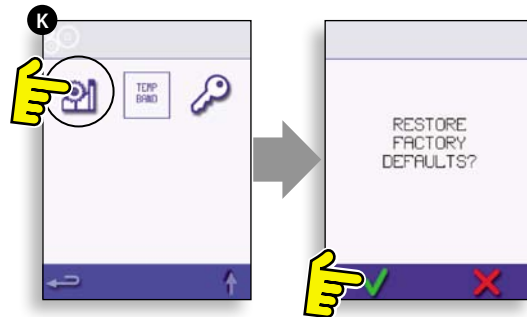

### 9.10 Temperature Band (L)

- 9.10.1 Select the 'Temp Band' symbol at which the oven controls i.e.  $\pm 10^{\circ}\text{C}$ .
- 9.10.2 Select the required temperature band checkbox, shown by a green tick. Note; although the lowest practical Temp Band should be used, if the set oven temperature falls by more than the selected Temp Band, the ready to cook mode and Temp Band are deactivated until the oven reaches the preheat temperature.

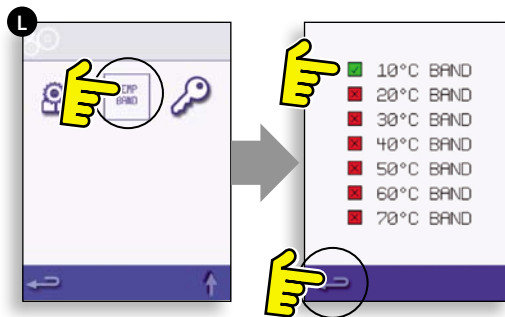

### 9.11 Change Password (M)

- 9.11.1 Select the key symbol to change the oven passwords.
- 9.11.2 Select the oven Settings or Service symbol.
- 9.11.3 Enter the existing password and select OK to confirm.
- 9.11.4 Enter the new password, select OK.
- 9.11.5 Confirm new password, select OK.

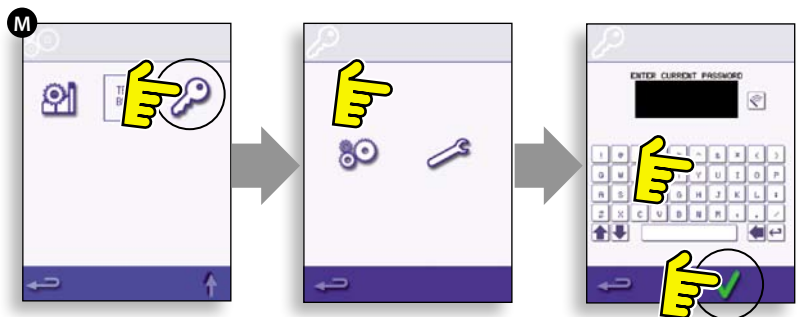



# 10 COOLING THE OVEN DOWN BEFORE CLEANING

## 10.1 Oven cool down

**IMPORTANT:** the oven must be cooled down before the cleaning processes are carried out.

1. In Full Serve mode, select the CLEANING symbol from the main menu.
2. In Full or Quick Serve mode, select the blue thermometer symbol to disable heating and start the cooling cycle.
3. Taking all necessary precautions place a suitable heaped container of ice, into the hot oven cavity. Select the OK symbol to continue.
4. The cooling progress is displayed and takes approximately 30 minutes.
5. The oven is now ready for cleaning. Select OK on the screen after completing each stage.

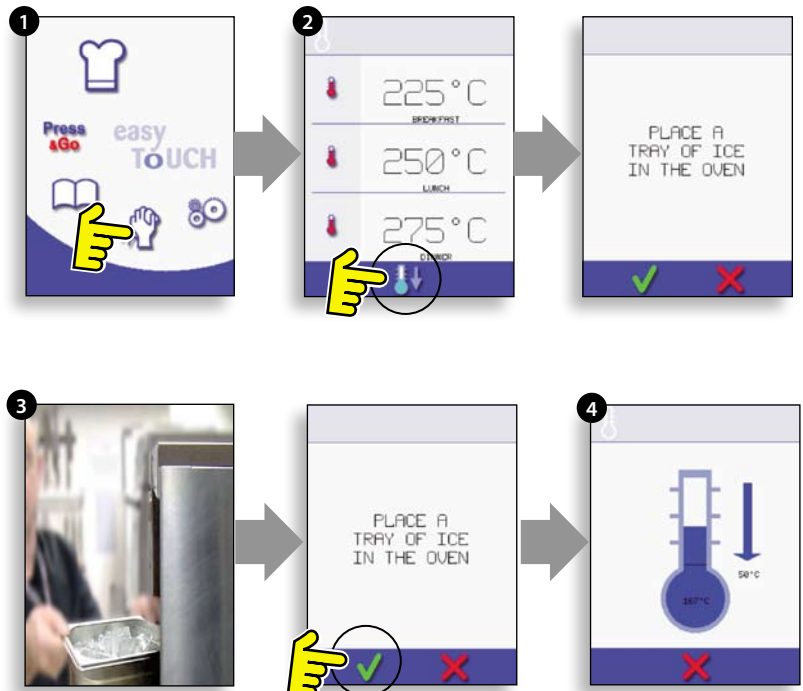

PRODUCT  
DETAILS

## 10.2 Preparing to clean the oven

For the oven to operate at peak efficiency, the cavity, door, air filter and grease filter must be kept clean.

A daily cleaning routine will ensure that you comply with the required hygiene standards and will help to maintain and prolong the efficiency of your oven.

### Equipment required (not supplied):

Non-caustic proprietary branded oven cleaner, heat proof gloves, protective rubber gloves, non-abrasive nylon scrub pad, cleaning towel and cloths, eye protection and dust mask (optional).

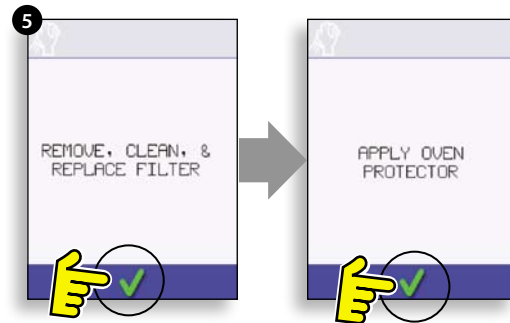

**CAUTION: WEAR PROTECTIVE RUBBER GLOVES WHEN CLEANING THE OVEN.**

**NEVER** use sharp implements or harsh abrasives on any part of the oven.



**WARNING: DO NOT USE CAUSTIC CLEANERS ON ANY PART OF THE OVEN OR OVEN CAVITY AS IT WILL CAUSE PERMANENT DAMAGE TO THE CATALYTIC CONVERTORS**

# 11 Cold oven CLEANING INSTRUCTIONS

Complete COOL DOWN procedure and allow the oven and accessories to cool before commencing cleaning.

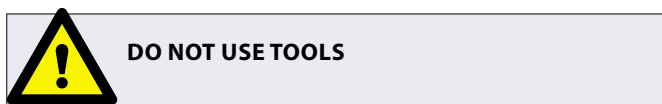

## REMOVE & CLEAN Oven Parts:

1. Remove the air filter at the base of the oven.
  2. Remove any cooking trays/rack from the oven cavity. For ovens with a catalytic converter; open the oven door and undo fasteners to remove the catalytic converter every month or when required.
  3. Wash all parts in warm soapy water. Wash off using a clean cloth and plenty of clean, warm water.
- Dry using a fresh, clean cloth.



## CLEAN THE OVEN:

1. Remove any spillages with disposable paper wipes. Use a dry clean brush to remove any food particles from between the oven floor and the inside of the front door.
2. Wear protective rubber gloves and protective glasses, carefully spray a non-caustic proprietary branded Oven Cleaner onto all the internal surfaces of the oven except the door seal (A).

**DO NOT spray directly into the fan opening at the rear inside of the oven.**

3. For difficult areas, leave to soak for 10 minutes with the oven door open.

Use a non-abrasive nylon scrub pad/sponge to clean the cavity, roof and the inside of the door. Do not scrub the door seal or use metallic scourers.

4. Wash off using a clean cloth and plenty of clean warm water and dry using a fresh clean cloth or paper towel.

Replace all the cleaned oven parts.

Close the oven door and wipe the outside of the oven with a damp cloth.

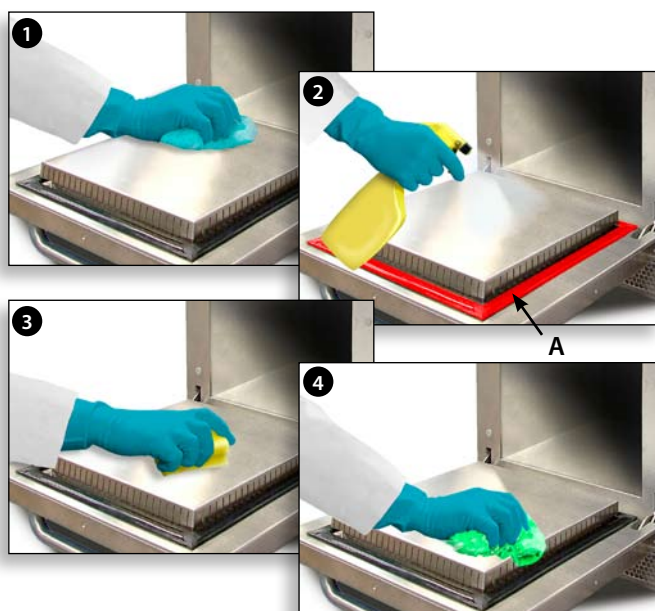

## APPLY OVEN PROTECTOR:

1. Only apply to a clean oven. Spray proprietary branded Oven Protector onto a sponge.
2. Spread Oven Protector lightly onto all internal surfaces of the oven.
3. Spread Oven Protector lightly onto the internal surface of the oven door avoiding the door seal.

Switch on the oven and preheat. When the oven has reached operating temperature it will take about 30mins to cure the Oven Protector.

**Note: Oven protector turns light brown when cured.**

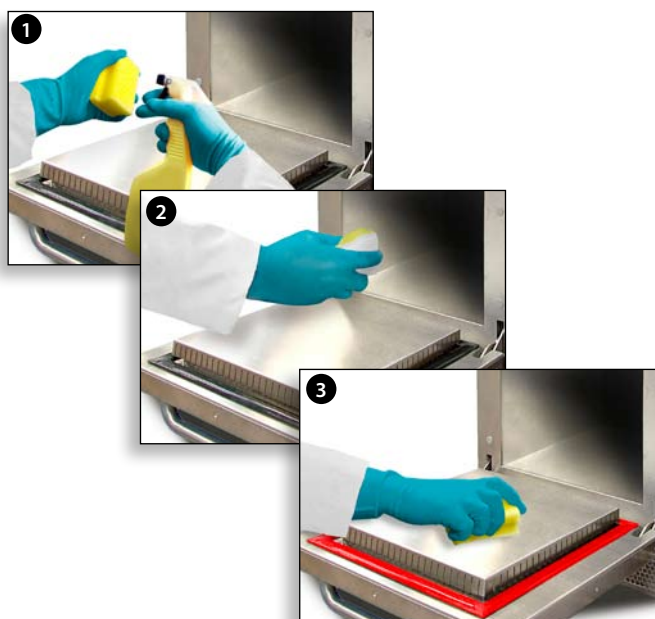

## 12 SERVICING THE OVEN

### 12.1 Servicing Procedure:

12.1.1 Disconnect/isolate the oven from the power supply.

12.1.2 Check the oven is correctly installed as described in the Installation Instructions (Product Details section).

12.1.3 Visually check the cleanliness/condition of the power supply/cable/gland, oven casing, cavity and door for signs of wear, damage, distortion etc., if required, refer to the 'Spares & Replacement' section.

12.1.4 Complete an 'Earth/Insulation test' (Testing Components section) on the oven before switching on.

12.1.5 Check the display for Error messages, if an Error is shown, refer to 'Errors & Diagnostics' (Servicing section).

12.1.6 Note: If a Firmware update is required, follow the instructions under 'Firmware Updates' (Servicing section) before continuing with the service procedure.

### 12.2 Enter Service mode:

- 1 On start up, tap the top right of the main menu screen to bypass oven preheat.
- 2 Enter the authorised user password, for example, **MANAGER** and select **OK** to display the Settings menu.
- 3 Select the spanner symbol.
- 4 Enter the service password, for example **SERVICE** on the keyboard and select **OK** to display the error log, service information and test options.

12.2.1 Check the Error Log for details of any logged oven errors. See 'Errors & Diagnostics' (Servicing section) for more details.

12.2.2 Check the 'Oven Counters' to find the usage of components and the Controls area temperature within the cabinet. ('Errors & Diagnostics', Servicing section).

12.2.3 Check the operational performance of the main components using the Visual or Data View ('Errors & Diagnostics', Servicing section).

12.2.4 Perform the Oven tests, (Testing Components section). If required refer to the 'Spares and Replacement' section for any repairs needed before continuing with the Oven Tests.

12.2.5 Follow the procedures under the 'Commissioning' section before commissioning the oven for use.



**DANGER:**  
BEFORE REMOVING THE OVEN CASING, ISOLATE THE OVEN FROM THE MAINS ELECTRICITY POWER SUPPLY; SWITCH OFF, DISCONNECT OVEN PLUG FROM WALL SOCKET, TURN OFF ISOLATOR SWITCH TO DISCONNECT FIXED WIRED OVENS AND LOCK-OFF.



**WARNING:**  
ALLOW OVEN TO COOL AND OBSERVE AND FOLLOW ALL SAFETY PRECAUTIONS INCLUDING THOSE DESCRIBED UNDER THE SAFETY REGULATIONS SECTION OF THIS MANUAL BEFORE ATTEMPTING A SERVICE OR REPAIR.



**CAUTION MICROWAVE EMISSIONS:**  
DO NOT BECOME EXPOSED TO EMISSIONS FROM THE MICROWAVE GENERATOR OR PARTS CONDUCTING MICROWAVE ENERGY.

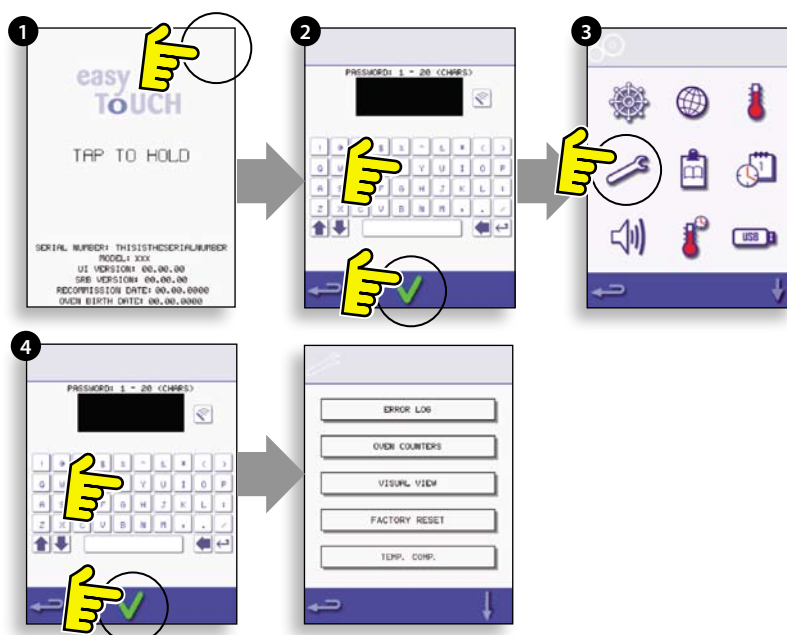

# 13 ERRORS & DIAGNOSTICS

## 13.1 ERROR MESSAGES

13.1.1 A description of the type of error is shown. Check for a number following 'ERROR:' (A) and refer to the Error Codes (Fault Finding section) for more details. The Oven Serial Number, Model, UI (BTS) version and SRB version information is also displayed below.

13.1.2 Clear the Error message by power cycling the mains power supply to the oven (not the oven ON/OFF switch).



## 13.2 COPYING ERROR MESSAGES:

13.2.1 Enter oven settings menu (B) and select the USB symbol.

13.2.2 Slide up the USB cover and insert the USB memory stick.

13.2.3 Select Upload Files.

13.2.4 Select Error Log.

13.2.5 Select OK to copy the Error Log to the USB memory stick. The upload progress is shown followed by the upload status.

13.2.6 Select backspace 3 times to return to the main menu.

13.2.7 Remove the USB memory stick and replace the USB cover.

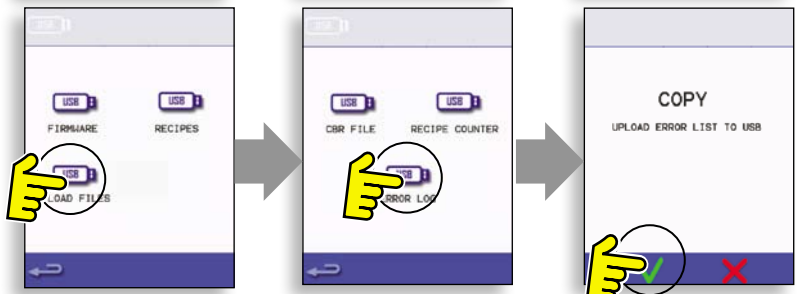
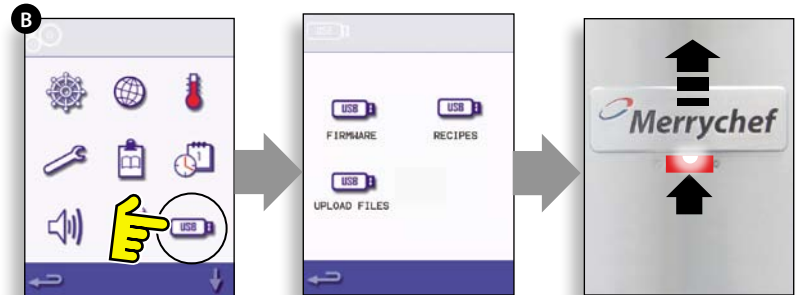

## 13.3 ERROR LOG

13.3.1 Enter Service Mode and select 'ERROR LOG' (C) to display a listing of oven component errors. Error details include; component description, error caused, Date & Time of the Error with details of Failure and Range.

13.3.2 Scroll down the list (if necessary) and select an error from the list to display individual records.

13.3.3 Select backspace to return to the list, again to return to the Service menu.

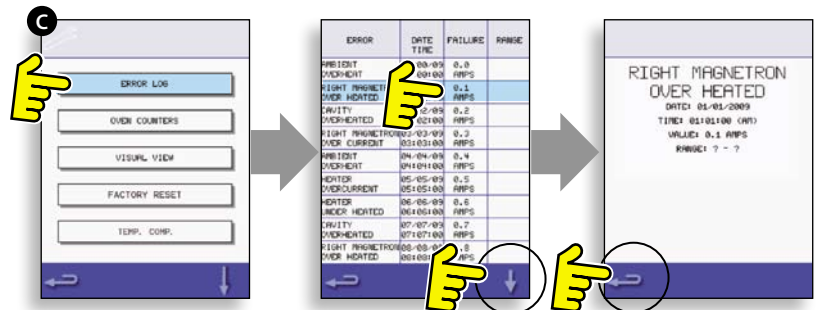

## 13.4 OVEN COUNTERS

13.4.1 Select 'OVEN COUNTERS' (D) to display the oven component usage and ambient Controls area temperature. Details include the number of screen touches, filter cycles, door cycles, total Oven, Magnetron and Heater element power on time and the ambient controls area temperature in the cabinet.

13.4.2 Select backspace to return to the Service menu.

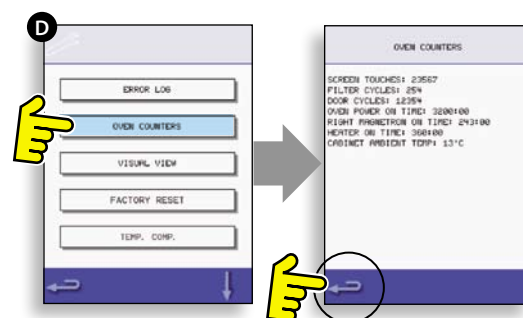



## 13.5 VISUAL VIEW

13.5.1 Select VISUAL VIEW (E) to check the main oven components. Select a component symbol to switch on (red), select again to increase the level or turn off (green).

13.5.2 Remove the front air intake filter, the colour should change from green to red on the display indicating that the magnetic reed switch circuit for the air intake filter is operating. Replace the filter and the colour should change back to green.

13.5.3 Open the oven door and check the colour changes from green to red on the display to check the door microswitch/interlock circuit is operating. Place door spacers onto the oven door (refer to Door Interlock Adjustment (Testing Components section) for details), close the door and check the colour on the display. Green indicates the door adjustment is ok, red indicates that the Door Interlock Adjustment procedure must be completed.

13.5.4 Select the cooling fan and check it's operating correctly.

13.5.5 Place a microwave safe container of water into the oven, close the oven door and select a magnetron to test the current draw at maximum output, this will time-out after 30 seconds. For dual magnetron models, test the magnetrons individually and together. Using heat proof gloves, remove the container and close the oven door.

13.5.6 Select the Convection Fan and check it is operating correctly.

13.5.7 Select the Heating Element, it increases to maximum temperature then cycles (the Convection Fan is on by default). Check the cavity temperature and heater element current draw at maximum are correct.

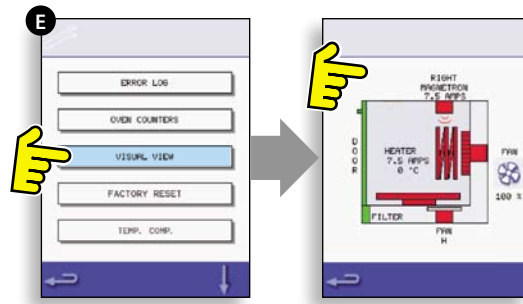

# 14 FIRMWARE UPDATES

Note: if icons are not displayed on the screen, press in the same positions on screen as the missing icons to select.

14.5.1 Tap the top right of the screen (1) or the same position if it is not displayed to bypass oven preheat.

14.5.2 Enter a password (i.e. "Manager") and select OK (2) or the same position if the green tick symbol is not displayed.

14.5.3 Select the USB symbol (3) or the same position if it is not displayed.

14.5.4 Select one of the USB options (4) or the same position if it is not displayed: 'Firmware' for BTS & SRB updates and 'Recipe' for Icons. Install the SRB update first, the BTS update second and Icons third.

14.5.5 Select the firmware to install and select OK (5) to confirm or the same position for the OK (green tick symbol), if it is not displayed.

14.5.6 The update screen displays the file version and product, select OK (green tick symbol) to confirm installation (6) or the same position if it is not displayed.

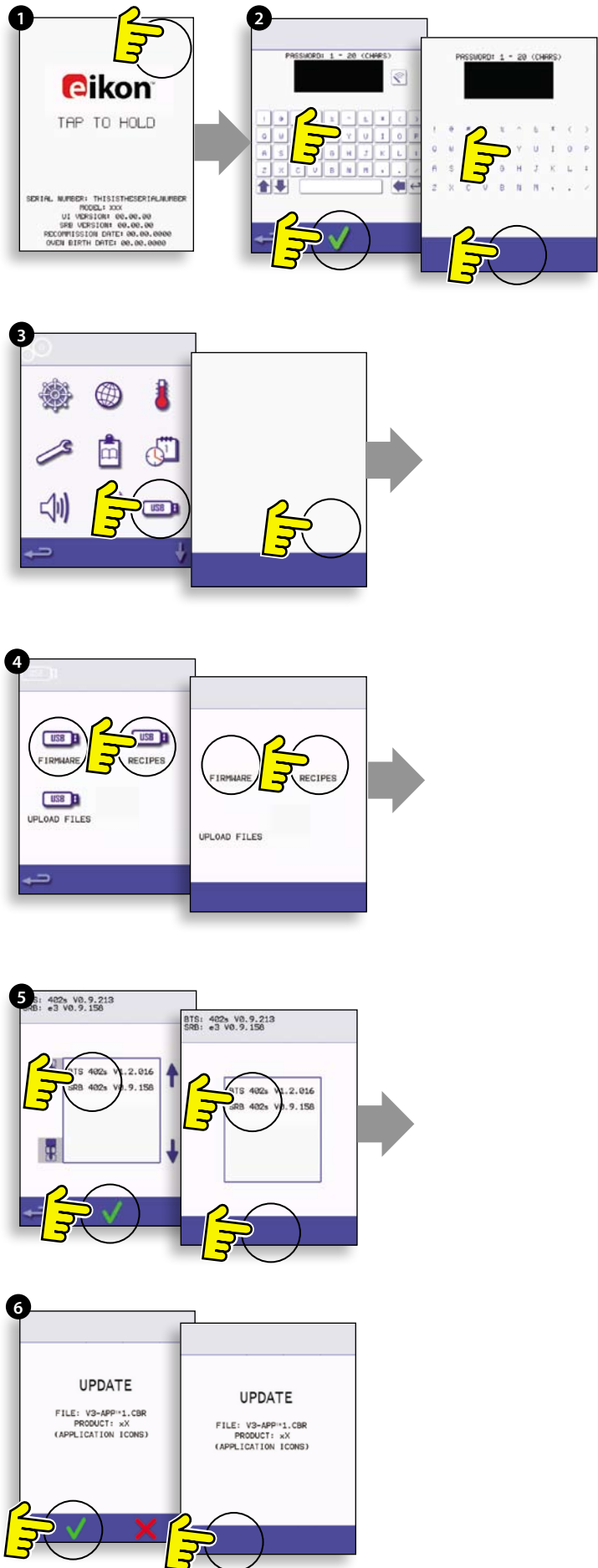

**IMPORTANT:**

**Downloading from a USB will clear all existing programs. Update the 'SRB' first, the 'BTS' second and the 'Icons' third (found under the USB 'Recipe' heading).**

14.5.7 Switch on the oven and tap the top right of the screen (1) to bypass the preheat stage.

14.5.8 Enter the password and select OK to display the Settings menu, see (2).

14.5.9 Select the USB symbol (4).

14.5.10 Slide the Merrychef badge (oven front top right) upwards and insert the USB Memory Stick into the slot (3).



**DO NOT REMOVE USB DURING DOWNLOAD SEQUENCE AS THIS COULD CORRUPT THE USB DATA.**

14.5.11 Once the USB has stopped flashing, select the 'FIRMWARE' USB symbol (5).

14.5.12 The current BTS (Touch Screen) & SRB (Smart Relay Board) Firmware versions are displayed at the top left of the screen (6).

**SRB FIRMWARE UPDATE**

14.5.13 Select the 'SRB' file required (7).

14.5.14 Check the file information is correct before selecting OK (8).

14.5.15 Update progress is displayed (9).

14.5.16 Select backspace (10) 3x to return to the USB screen shown (11).

14.5.17 If the firmware versions are far apart an SRB conflict could cause an error message (12) to be displayed.

**BTS FIRMWARE UPDATE**

14.5.18 Select the 'BTS' file (13) with the correct file version number. Note; a tinted band over a file name indicates the file is not valid for that oven.

14.5.19 Check the file information shown is correct before selecting OK (14), if not, select 'X' and locate the correct file.

14.5.20 The file update progress is displayed (15). At 50% the cooling fan stops operating, after 100% various screen displays appear as the software reboots.

14.5.21 Check the screen shows the correct BTS version was installed (16), if not, repeat the process using the correct file.

14.5.22 Remove the USB and keep in a safe place. Reposition the USB cover.

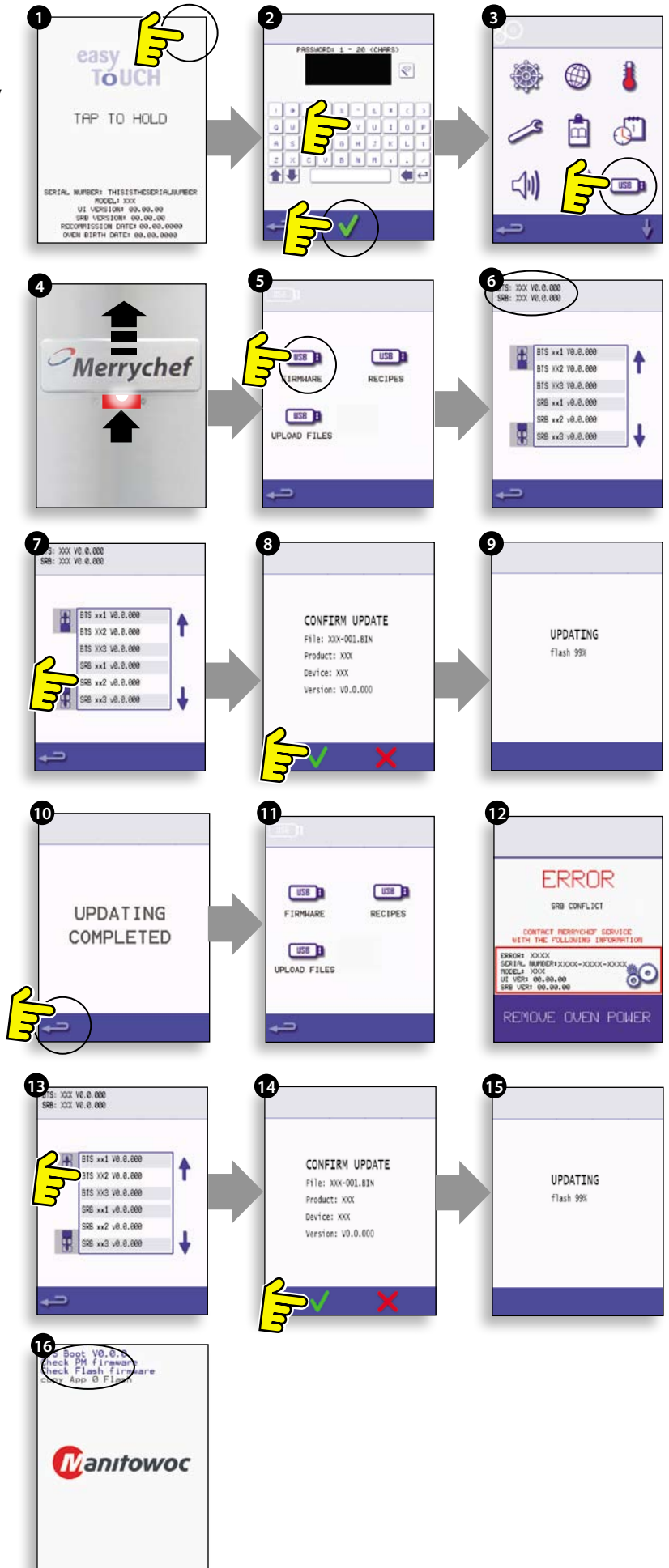

**SERVICING**

# 15 OVEN TESTING

## 15.1 Equipment required

- Portable Appliance Tester (P.A.T.).
- Digital Multi-meter (D.M.M.).
- Megger / similar 500V d.c. resistance meter.
- Microwave detection / leakage meter.
- Temperature reader.
- Continuity meter.
- Door Spacer Kit (Part No. SA1109).
- Microwave safe 600ml glass beaker
- Microwave safe 2 litre container.



**DANGER:**  
BEFORE REMOVING THE OVEN CASING, ISOLATE THE OVEN FROM THE MAINS ELECTRICITY POWER SUPPLY; SWITCH OFF, DISCONNECT OVEN PLUG FROM WALL SOCKET, TURN OFF ISOLATOR SWITCH TO DISCONNECT FIXED WIRED OVENS AND LOCK-OFF.



**WARNING:**  
ALWAYS DISCHARGE THE HT CAPACITORS BEFORE WORKING ON THE OVEN USING A SUITABLY INSULATED 10MΩ RESISTOR.



**WARNING:**  
ALLOW OVEN TO COOL AND OBSERVE AND FOLLOW ALL SAFETY PRECAUTIONS INCLUDING THOSE DESCRIBED UNDER THE SAFETY REGULATIONS SECTION OF THIS MANUAL BEFORE ATTEMPTING A SERVICE OR REPAIR.



**CAUTION MICROWAVE EMISSIONS:**  
DO NOT BECOME EXPOSED TO EMISSIONS FROM THE MICROWAVE GENERATOR OR PARTS CONDUCTING MICROWAVE ENERGY.



**DANGER!**  
THIS APPLIANCE MUST BE EARTHED. FAILURE TO DO SO MAY RESULT IN ELECTRIC SHOCK AND DEATH.

## 15.2 Earth/Insulation Test:

- 15.2.1 Disconnect/isolate the oven from the power supply.
- 15.2.2 Connect the mains lead from the oven to a P.A.T. (Portable Application Tester).
- 15.2.3 Connect the Earth from the P.A.T. to the oven hinge (A).
- 15.2.4 Place the P.A.T. in an open area, such as the floor, away from any persons.
- 15.2.5 Perform a Class 1 test, a PASS indicates the oven Earthing circuit is functioning ok.
- 15.2.6 If a FAIL is indicated, remove the oven casing and check ALL earth connections before retesting.
- 15.2.7 NEVER operate an oven that has failed this test as it could be potentially dangerous.



## 15.3 Screen calibration:

- 15.3.1 Apply continuous light pressure to the top right of the screen while switching the oven on.
- 15.3.2 Using a non-abrasive pointer, such as a ball point pen, accurately press the center of each crosshair displayed on the screen. Once calibrated the screen will display the oven information.

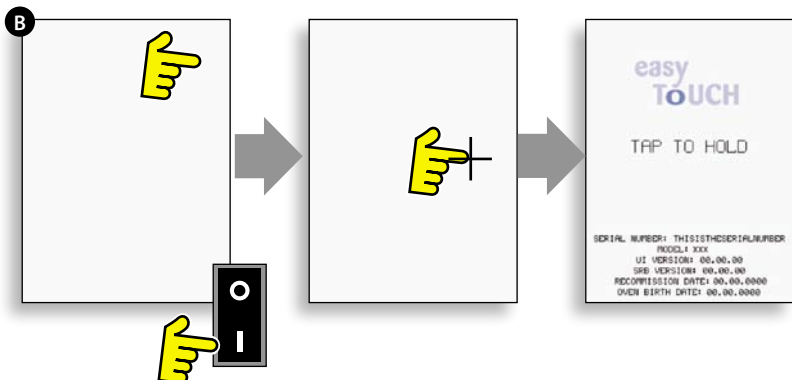

## 15.4 OVEN TESTS

15.4.1 Enter Service mode (Servicing section).

15.4.2 Select the down arrow to display the individual Oven tests (A) for the oven to perform.

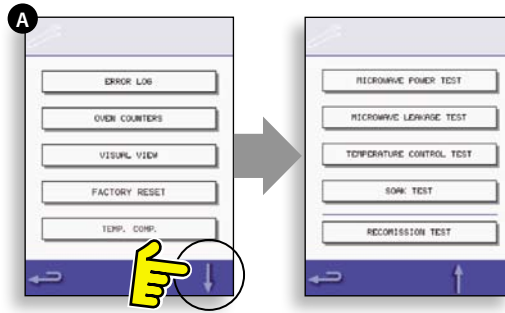

## 15.5 Microwave Power Test

### Measuring the power output.

*Note: The power output is established under IEC 705 standard method which is only workable in Laboratory controlled conditions. Power output is also affected by line voltage under load, so this test is an approximation only.*

15.5.1 Ensure the oven is cold, then enter Service mode to bypass oven preheating.

15.5.2 Select Visual View (B) to check the oven cavity temperature reading is as close to 0°C as possible.

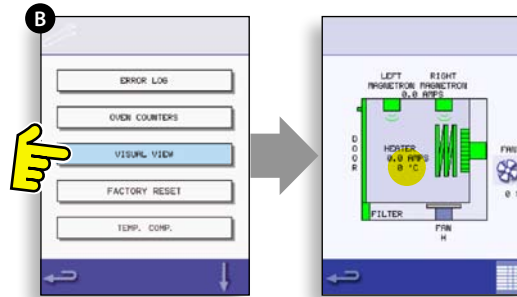

**1** Fill a microwave safe container (glass or plastic) with one litre (1.78 pints) of tap water at about 20°C (68°F).

**2** Measure and record the water temperature in the container using a thermometer capable of reading  $\pm 0.1$  degree increments.

**3** Place the container centrally inside the oven.

**4** Select 'Microwave Power Test' (C) from the service mode tests. (Microwave power 100% for 63 seconds, fan minimum).

**5** When the countdown has finished, remove the container from the oven, immediately stir with a plastic implement and measure the water temperature.

**6** Calculate the temperature rise of the water (end temperature minus the start temperature).

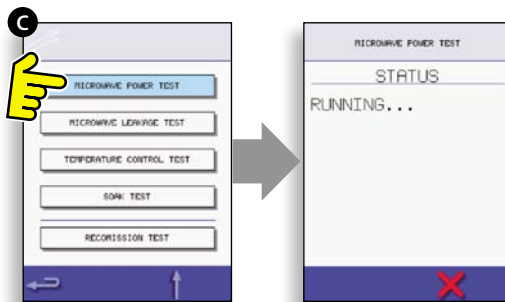

The Temperature Rise should be:

20°C (68°F)  $\pm 5\%$

### If the temperature rise is outside these limits:

- Check the microwave circuit and components, (Testing Components section).

## 15.6 Microwave Leakage Test

### Note before measuring.

- Make sure that the survey meter you are using has been calibrated and is suitable for measuring frequencies of 2,450 MHz.
- Do not exceed meter full scale deflection, leakage meter should initially be set to the highest scale, then adjusted down as necessary to ensure that low readings are measured on the most sensitive range.
- To prevent false readings, hold the probe on the grip provided and move at 2.5cm/second.
- Always hold the probe at right angles to the oven and point of measurement, ensuring the probe is reading 50mm from the test area.
- With any casework removed the leakage should not exceed 5mW/cm<sup>2</sup>.

### Procedure

15.6.1 Add 275ml of cold water into a 600ml microwave safe container.

15.6.2 Place the 600ml container in the centre of oven and close the door.

15.6.3 Enter Service mode and select 'Microwave leakage test' (A) from the oven tests.

15.6.4 Set the leakage meter to the appropriate scale/range.

15.6.5 Move the survey meter probe across all casework joins and vent areas including those marked in yellow, shown opposite.

15.6.6 When the Magnetron circuit stops after 30 seconds, change the water and re-select the test to continue.

15.6.7 Select the red 'X' on the display to stop the test at any time.

15.6.8 Readings must be below 5mW/cm<sup>2</sup>. If a level greater than 5mW/cm<sup>2</sup> is observed, this should be reported to Merrychef Service Department immediately.

15.6.9 Notes should be kept of any leakage that is observed in terms of the level and position on the oven. This information should be kept with the service documentation.

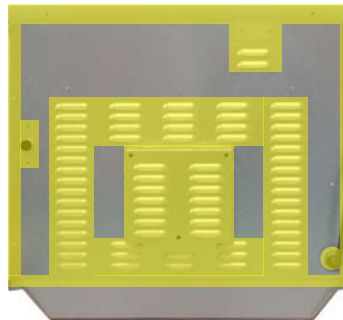
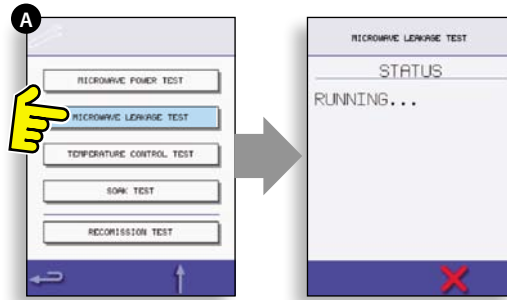



## 15.7 Temperature Control Test

### Measuring the oven cavity temperature.

(Note; re-calibrating the Thermocouple with the SRB is normally only required when the Thermocouple has been replaced or the oven is under or over cooking.)

#### Procedure:

15.7.1 Place the probe of a temperature reader (A) onto a heat sink in the centre of the oven cavity and close the oven door.

15.7.2 Select 'Temperature Control Test' (B) from the service mode tests. The oven heats up and cycles at the maximum set point temperature over 30 minutes.

15.7.3 Once the oven is up to maximum temperature check for a stable temperature reading.

15.7.4 Select the red X to finish the test, if necessary.

15.7.5 If the temperature reading is different to the maximum set point, scroll up (C) to select TEMP. COMP. (Temperature Compensation) (D) and enter the password.

15.7.6 Enter the figure from the temperature reader on the keypad (E) and select OK to calibrate the SRB to the thermocouple.

15.7.7 Retest to check that the oven cavity temperature reading is the same as the oven maximum set point temperature.

#### If the temperature reading is unstable:

- 1 Disconnect and isolate the oven from the electricity supply.
- 2 Allow the oven to cool down.
- 3 Remove the oven casing.
- 4 Check the cavity temperature sensor wire and connections.
- 5 If the wire and connections are ok; replace the cavity temperature sensor (see Spares & Replacement section).
- 6 Replace oven casing, switch ON and retest.
- 7 If the temperature is still unstable repeat steps 1 to 3, replace the SRB (see Spares & Replacement section), repeat step 6. NOTE: reuse the existing PM (Personality Module) on the new SRB (enter Serial No. on reboot).

15.7.8 Repeat the Temperature Control Test procedure.

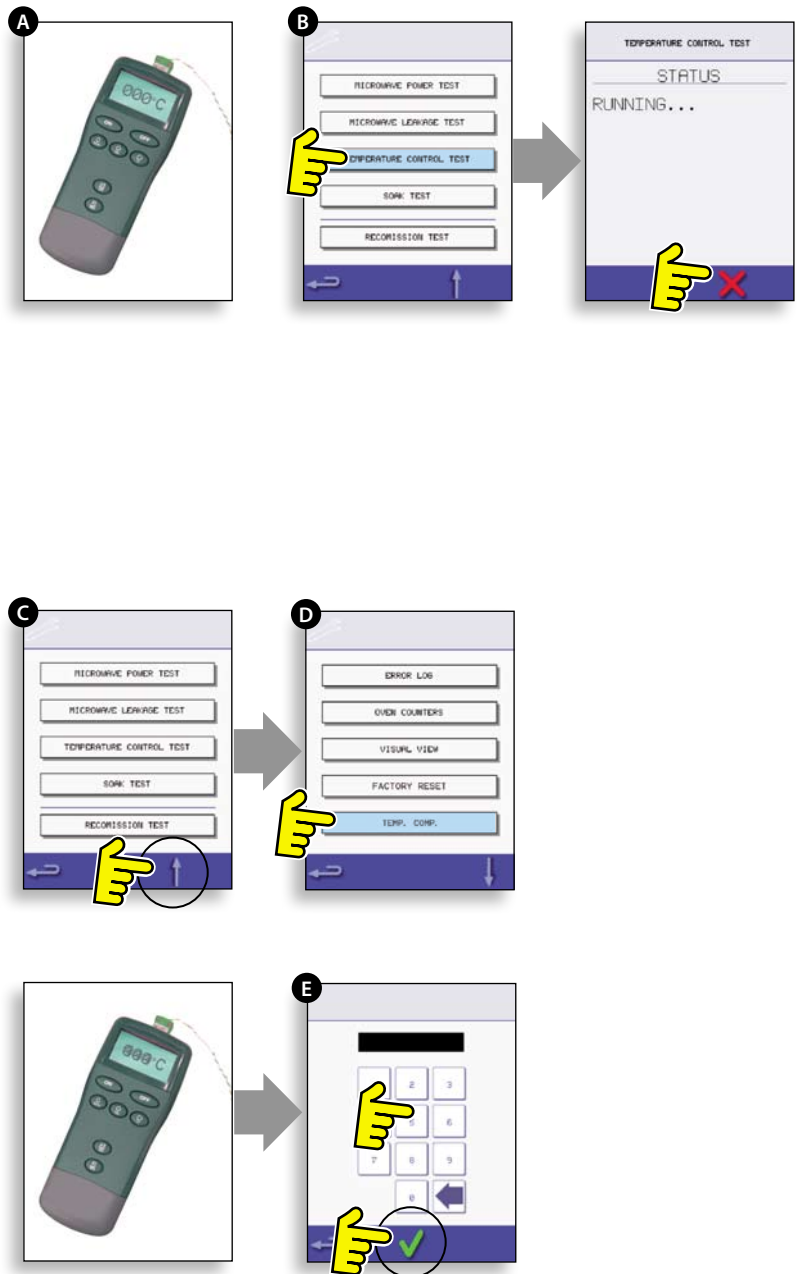

## 15.8 Soak Test

### Checking the oven cavity integrity.

#### Procedure:

15.8.1 Place an oven/microwave safe container with approx. 2 litres of water into the oven.

15.8.2 Close the oven door and select 'Soak Test' (A) from the Service mode oven tests (maximum oven temperature, 50% microwave power, maximum fan speed).

15.8.3 Run the test (30 minutes), carefully checking the oven casing, joints and door seal for signs of steam or water escaping from the oven cavity.

15.8.4 If necessary, rectify any leaks and repeat the test.

15.8.5 Safely remove the container from the oven.

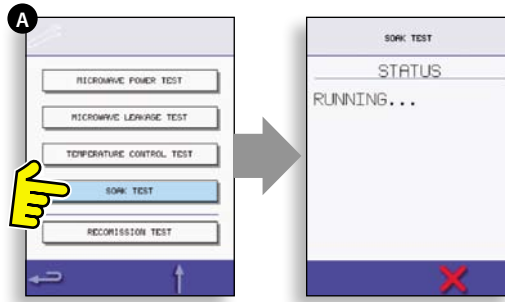

## 15.9 Recommission Test

The Recommission tests are performed following the completion of a service or repair to ensure the oven is operational before handing back to the customer.

Some of the tests have a countdown timer where failing to carry out a test within the time limit will cause a test failure and the Recommission test will have to be restarted.

#### Procedure:

15.9.1 Select 'Recommission Test' (A) from the service mode oven tests and follow the on screen instructions to perform the tests. Do not select the red 'X' unless you want to stop the test.

15.9.2 After a test has successfully passed, select OK to continue.

15.9.3 When all the tests have been successfully performed the display shows the Recommission test has passed, select OK to confirm.

15.9.4 In the event of a Recommission test failure, the detail will be recorded in the Error log. Any error should be rectified and the Recommission test run again.

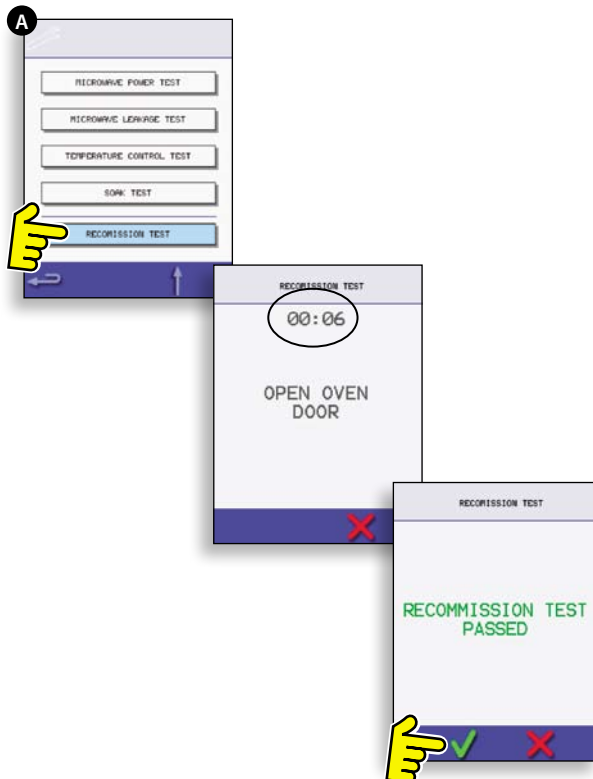



# 16 HIGH VOLTAGE COMPONENTS

High voltages and large currents are present at the High Voltage Capacitor. It is very dangerous to work near this part when the oven is on. NEVER make any voltage measurements at the High Voltage circuits, including the magnetron filament.

Even when the oven is not cooking, the High Voltage Capacitor has High Voltages present because of the Soft Start circuit.

## 16.1 Power Transformer Test

16.1.1 Disconnect and isolate the oven from the electricity supply.

16.1.2 Allow the oven to cool down.

16.1.3 Remove the oven casing.

16.1.4 Ensure that the High Voltage Capacitor is discharged before commencing work.

16.1.5 Remove all connections from the Power Transformer.

16.1.6 Using a D.M.M., check the resistance of the windings. Results should be as follows:

- 1 Mains winding between tags, approx.  $1.1 \Omega$
- 2 High Voltage winding, approx.  $60 \Omega$
- 3 Filament winding between terminals, less than  $1 \Omega$

16.1.7 Using a Megger, test the insulation resistance between:

- Primary winding and chassis, pass if reading is over  $10 M\Omega$
- Filament winding and chassis, pass if reading is over  $10 M\Omega$

One end of the High Voltage winding is connected to the chassis, so this is not tested.

## 16.2 High Voltage Rectifier Test (Diode Board)

16.2.1 Disconnect and isolate the oven from the electricity supply.

16.2.2 Allow the oven to cool down.

16.2.3 Remove the oven casing.

16.2.4 Ensure that the High Voltage Capacitor is discharged before commencing work.

16.2.5 Remove all connections from the High Voltage Rectifier.

16.2.6 Using a Megger, test for continuity in both directions. Results should be as follows:

- Open circuit both ways - FAIL
- Conducts one-way only - PASS
- Short circuit both ways - FAIL
- Conducts one way, leaks the other - FAIL



**DANGER:**  
BEFORE REMOVING THE OVEN CASING, ISOLATE THE OVEN FROM THE MAINS ELECTRICITY POWER SUPPLY; SWITCH OFF, DISCONNECT OVEN PLUG FROM WALL SOCKET, TURN OFF ISOLATOR SWITCH TO DISCONNECT FIXED WIRED OVENS AND LOCK-OFF.



**WARNING:**  
ALWAYS DISCHARGE THE HT CAPACITORS BEFORE WORKING ON THE OVEN USING A SUITABLY INSULATED  $10M\Omega$  RESISTOR.



**WARNING:**  
ALLOW OVEN TO COOL AND OBSERVE AND FOLLOW ALL SAFETY PRECAUTIONS INCLUDING THOSE DESCRIBED UNDER THE SAFETY REGULATIONS SECTION OF THIS MANUAL BEFORE ATTEMPTING A SERVICE OR REPAIR.



**CAUTION MICROWAVE EMISSIONS:**  
DO NOT BECOME EXPOSED TO EMISSIONS FROM THE MICROWAVE GENERATOR OR PARTS CONDUCTING MICROWAVE ENERGY.

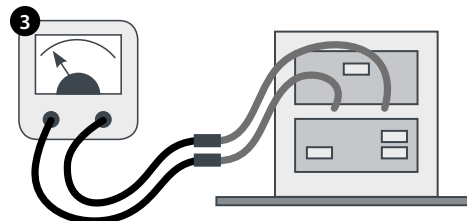
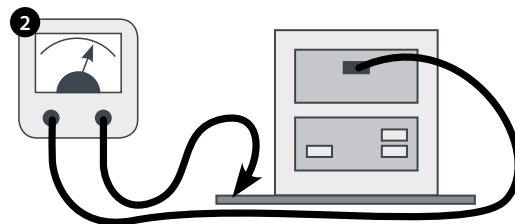
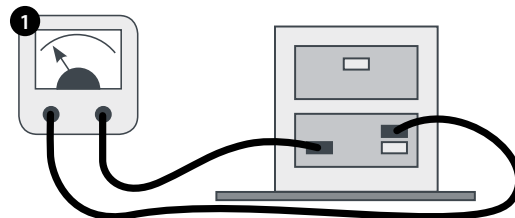

**High voltages and large currents are present at the High Voltage Capacitor. It is very dangerous to work near this part when the oven is on. NEVER make any voltage measurements at the High Voltage circuits, including the magnetron filament.**

**Even when the oven is not cooking, the High Voltage Capacitor has High Voltages present because of the Soft Start circuit.**

### 16.3 High Voltage Capacitor Test

- 16.3.1 Disconnect and isolate the oven from the electricity supply.
- 16.3.2 Allow the oven to cool down.
- 16.3.3 Remove the oven casing.
- 16.3.4 Ensure that the High Voltage Capacitor is discharged before commencing work.
- 16.3.5 Remove all connections from the High Voltage Capacitor.
- 16.3.6 Using a D.M.M., check for continuity between the terminals. Results should be as follows:
  - 1 Between Terminals, pass if approx. 10 MΩ
  - 2 Between Terminals and case, pass if open circuit.
- 16.3.7 Using a Megger, test the insulation resistance between the Terminals and case, pass if reading is over 100 MΩ

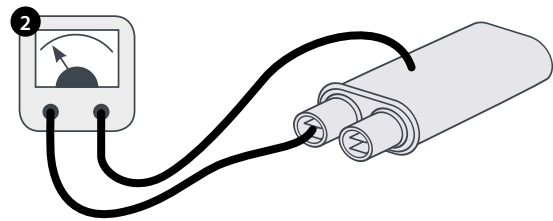
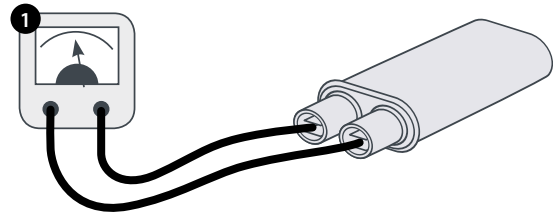

### 16.4 High Voltage Magnetron Test

- 16.4.1 Disconnect and isolate the oven from the electricity supply.
- 16.4.2 Allow the oven to cool down.
- 16.4.3 Remove the oven casing.
- 16.4.4 Ensure that the High Voltage Capacitor is discharged before commencing work.
- 16.4.5 Remove all connections from the High Voltage Magnetron.
- 16.4.6 Using a Megger check for continuity. Results should be as follows:
  - 1 Filament terminals, pass if 1 Ω or less.
  - 2 Between each filament terminal and the metal outer case should read open.

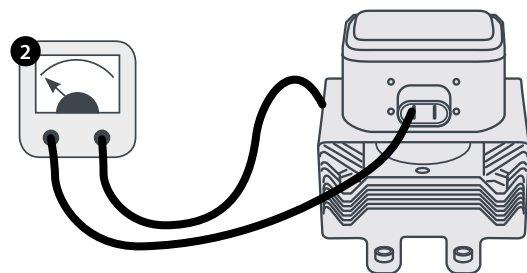
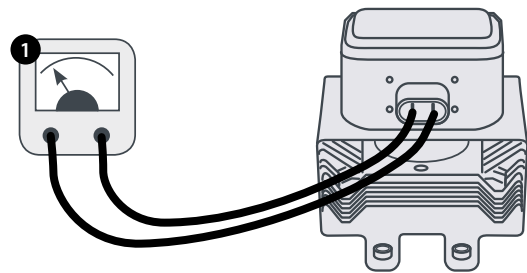

# 17 MAINS VOLTAGE COMPONENTS

## 17.1 Door Interlock Adjustment

Located on the door hinges are 3 safety interlock microswitches, to prevent microwave emissions escaping when the oven door is opened:

The Primary (SW3) breaks the electrical supply circuit to the transformers.

The Secondary (SW2) breaks the microwave circuit if the primary fails.

The Monitor switch (SW1) will short out the Microwave circuit blowing the fuse if both Primary and Secondary interlocks fail.

**IMPORTANT: in the event that the Monitor switch causes the Microwave circuit fuse to blow, the Secondary (SW2) and Monitor (SW1) microswitches must be replaced due to exposure from high short-circuit currents.**

The purpose of the following adjustment procedure is to set the interlock to switch off the Microwave circuit when the door is opened more than 4mm and for the Microwave circuit to operate when the door is closed and the door seal expands.

### 17.1.1 Door Interlock Adjustment procedure:

17.1.2 Disconnect and isolate the oven from the electricity supply.

17.1.3 Allow the oven to cool down.

17.1.4 Remove the oven casing.

17.1.5 Ensure that the High Voltage Capacitor is discharged before commencing work.

- 1 Position red 2mm spacers over the top corners of the door seal and carefully close the door ensuring the spacer is still in position.
- 2 Slacken the pivot screw.
- 3 Release the adjusting screws and move the backplate until microswitch SW3 just activates then secure all screws.
- 4 Open door to replace the red 2mm spacers with green 4mm spacers and close the door.
- 5 Slacken the pivot screw.
- 6 Release the adjusting screws and move the backplate until microswitch SW2 just activates then secure all screws.
- 7 Remove the spacers, then open and close the oven door 5-10 times.

**IMPORTANT: CHECK THE SWITCHES OPERATE IN THE FOLLOWING SEQUENCE AS MICROSWITCH SW3 MUST SWITCH THE LOAD CURRENT.**

#### Closing the door:

- SW1 opens first
- SW2 closes second
- SW3 closes third

#### Opening the door:

- SW3 opens first
- SW2 opens second
- SW1 closes third

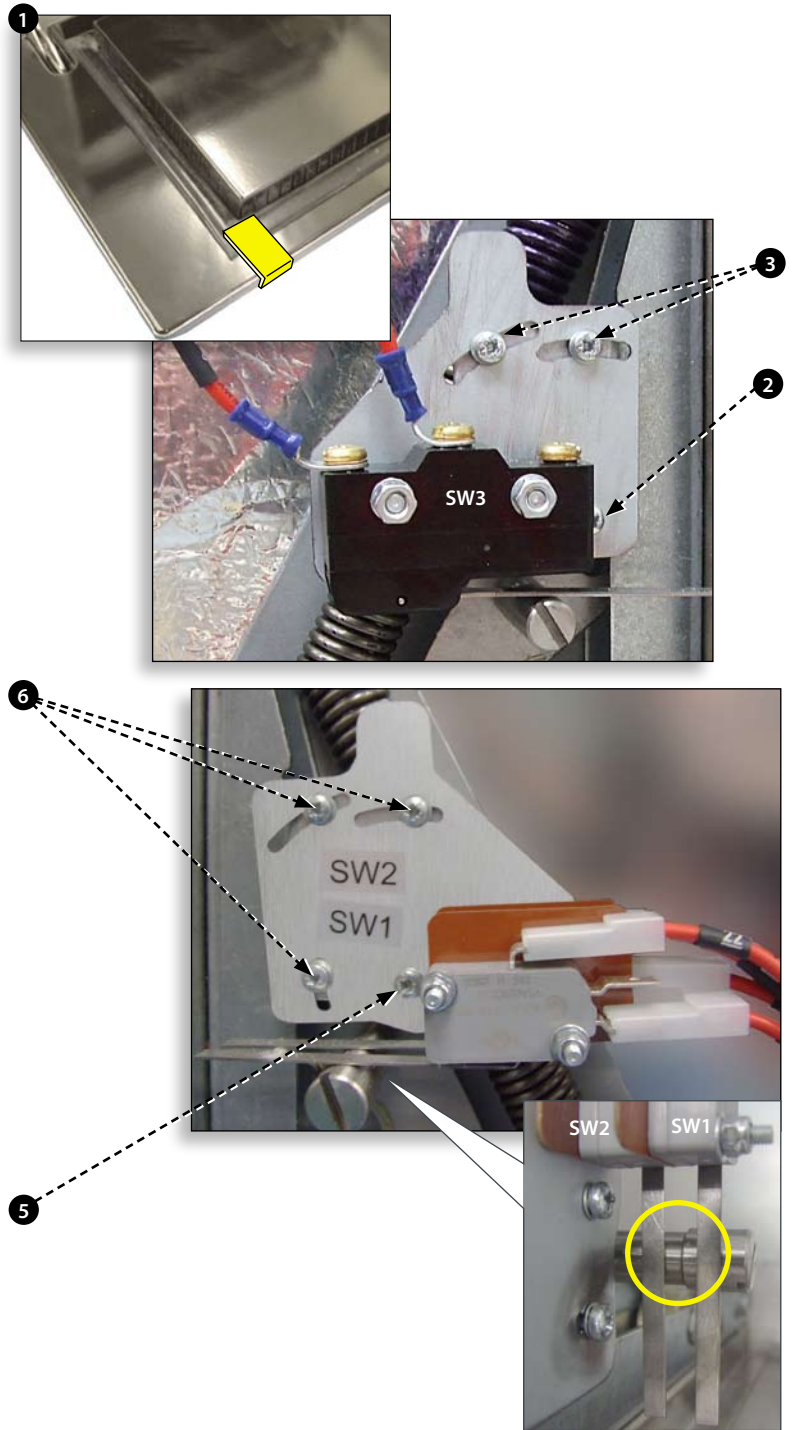

OVEN DOOR OPEN

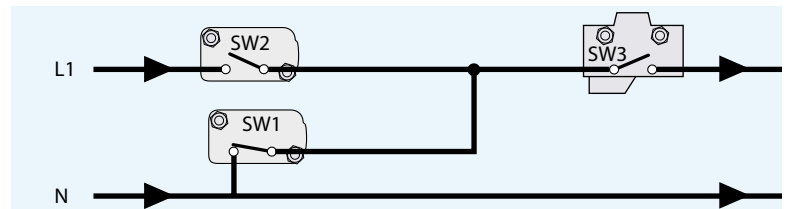

OVEN DOOR CLOSED

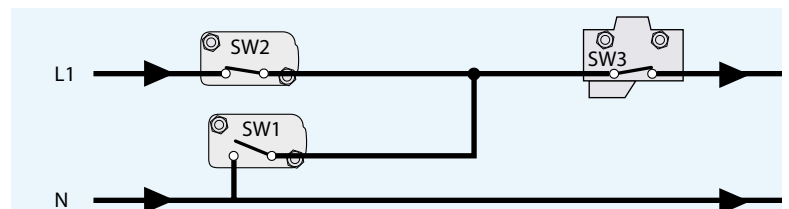

# 18 OVEN COMPONENTS



**DANGER:**  
BEFORE REMOVING THE OVEN CASING, ISOLATE THE OVEN FROM THE MAINS ELECTRICITY POWER SUPPLY; SWITCH OFF, DISCONNECT OVEN PLUG FROM WALL SOCKET, TURN OFF ISOLATOR SWITCH TO DISCONNECT FIXED WIRED OVENS AND LOCK-OFF.



**WARNING:**  
ALLOW OVEN TO COOL AND OBSERVE AND FOLLOW ALL SAFETY PRECAUTIONS INCLUDING THOSE DESCRIBED UNDER THE SAFETY REGULATIONS SECTION OF THIS MANUAL BEFORE ATTEMPTING A SERVICE OR REPAIR.



**CAUTION MICROWAVE EMISSIONS:**  
DO NOT BECOME EXPOSED TO EMISSIONS FROM THE MICROWAVE GENERATOR OR PARTS CONDUCTING MICROWAVE ENERGY.

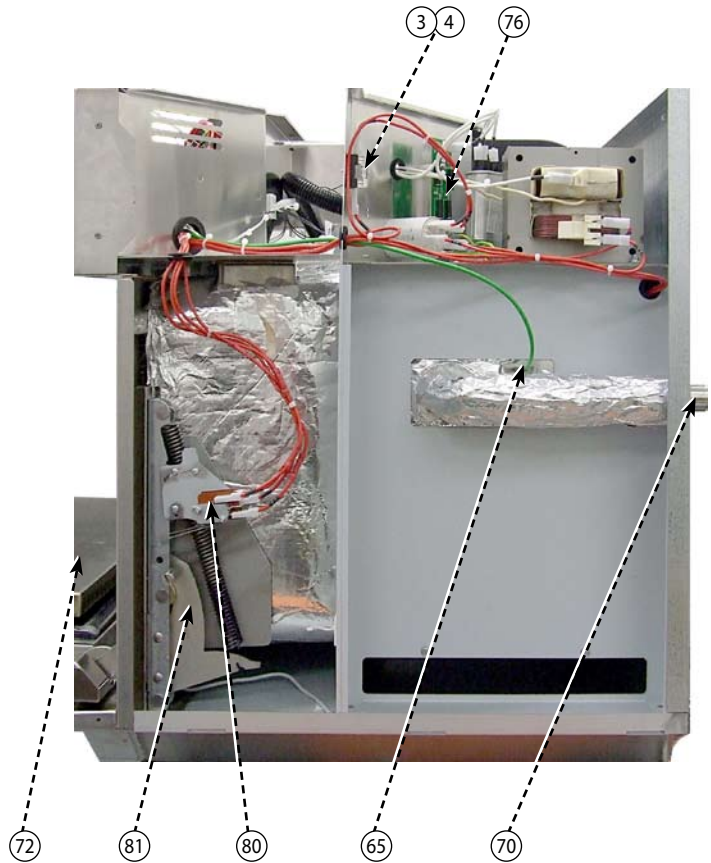

- 72 Door oven
- 81 Hinge assembly door RH
- 80 Microswitch SW1, SW2
- 3 Fuse HT Transformer (10A)
- 4 Fuse holder (13A)
- 76 HT Diode assembly PCB
- 65 Temperature sensor (Thermocouple) oven cavity
- 70 Vent steam outlet
- 11 Filter 16A
- 67 Overheat stat oven cavity manual reset
- 23 Connector Terminal block Mains power supply
- 9 Fuse Heater circuit (20A)
- 10 Fuse holder (30A)
- 6 Fuse Control circuit (3A)
- 82 Microswitch SW3
- 81 Hinge assembly door LH

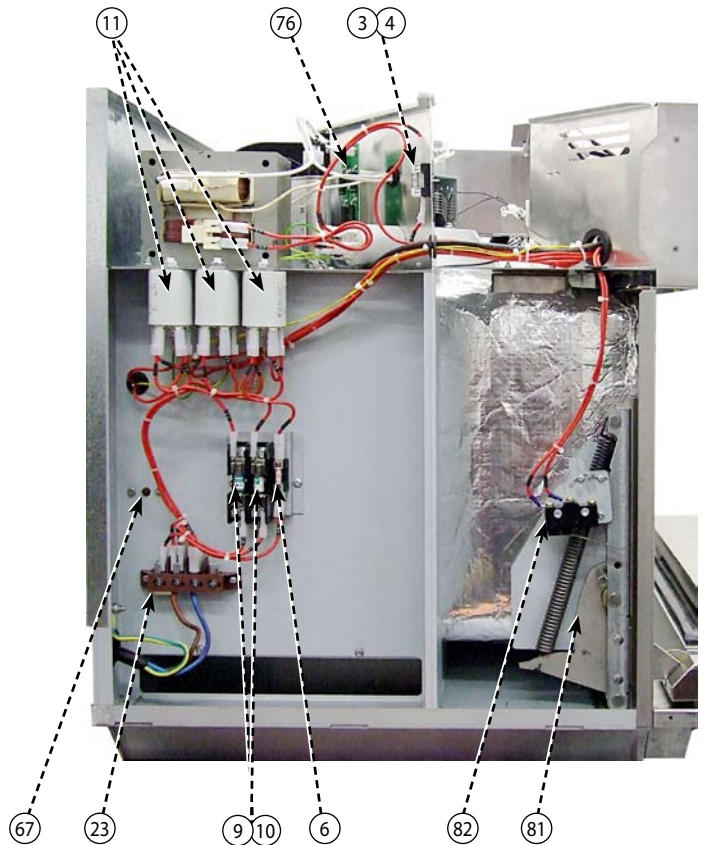



- 94 Transformer
- 83 HV capacitor
- 21 Connector block convection motor
- 13 Cooling fan motor
- 8 Capacitor 2 $\mu$ F (Blue) motor start
- 74 Motor assembly convection fan
- 58 Heater element x2 (connectors shown)
- 67 Overheat stat oven cavity
- 28 Gland Power supply cable
- 53 Wave guide LH
- 12 Magnetron LH
- 66 Speaker unit
- 15 Overheat stat Magnetron LH
- A (Detail A) Stirrer motor assembly
- 15 Overheat stat Magnetron RH
- 12 Magnetron RH
- 53 Wave guide RH
- 17 Motor start capacitor 2.5 $\mu$ F
- 18 SRB Smart Relay Board with in-built 1.25A fuse
- 19 BTS Touch Screen PCB
- 14 Transformer 24v
- 11 Filter HT Transformer

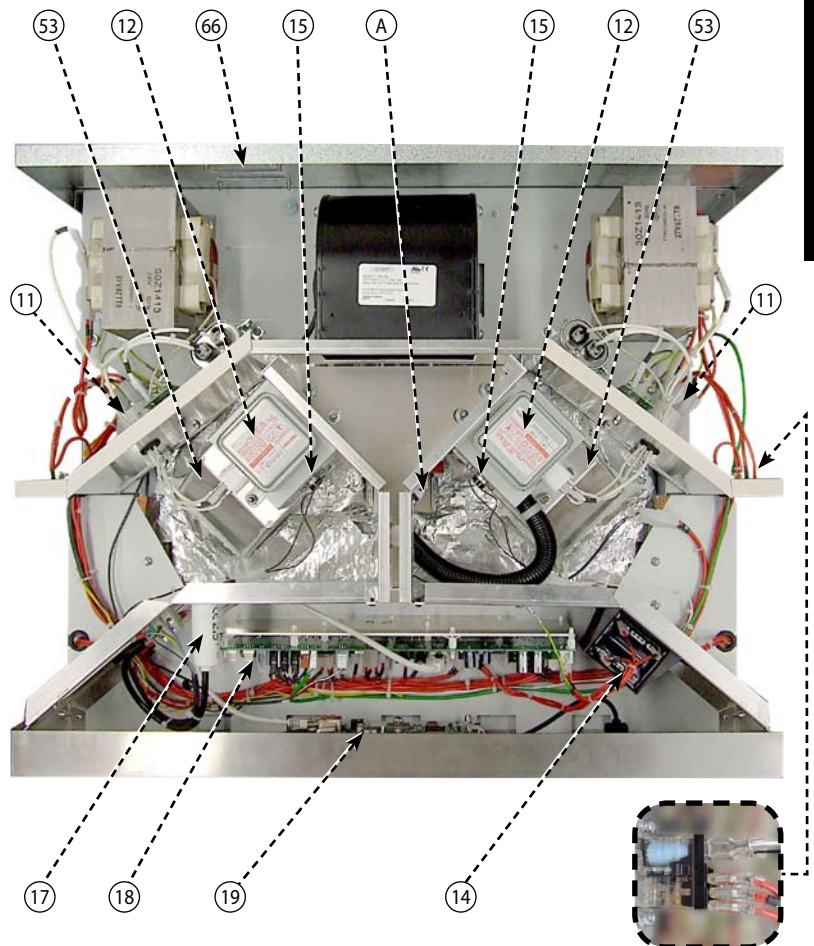
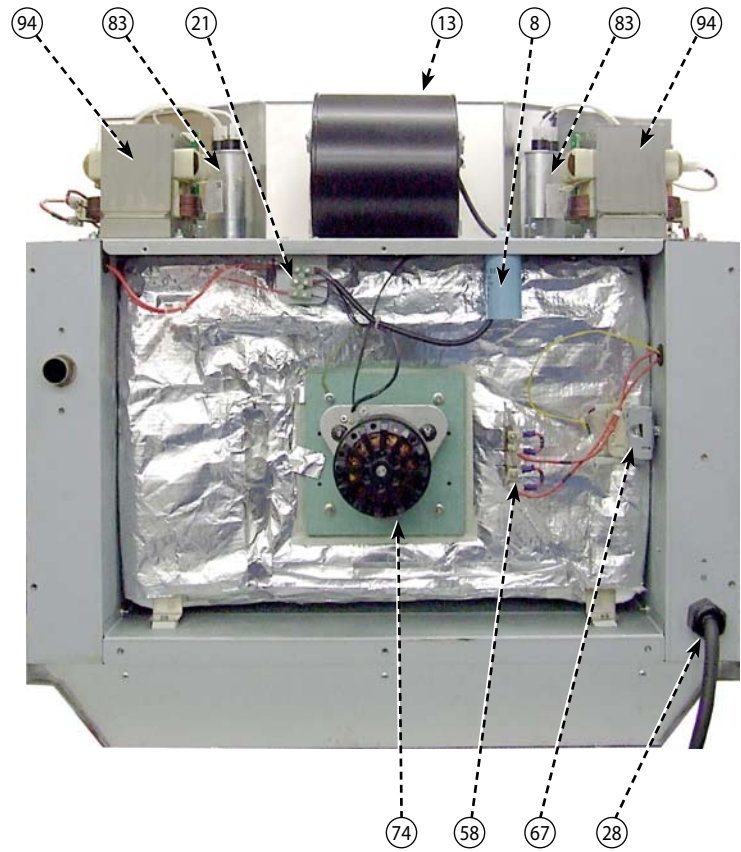

**SPARES & REPLACEMENT**

## 19 SRB & BTS Circuit Boards

### 19.1 SRB replacement

- 19.1.1 Disconnect and isolate the oven from the electricity supply.
- 19.1.2 Allow the oven to cool down.
- 19.1.3 Remove the oven casing.
- 19.1.4 Ensure that the High Voltage Capacitor is discharged before commencing work.
- 19.1.5 Taking anti-static precautions, disconnect all connections on the SRB.
- 19.1.6 Remove the PM (Personality Module) from the SRB and place safely aside.
- 19.1.7 Release retaining screws and remove the SRB.
- 19.1.8 Replace SRB and secure retaining screws.
- 19.1.9 Reconnect all connections to the SRB, for details see 'SRB Terminal Locations' (Electrical Circuits section).

- 1 Ensure the thermocouple negative (-) connection (white) and positive (+) connection (green) are fitted the correct way round or the oven temperature readings will be wrong.
- 2 Refit the PM removed from the old SRB to the new SRB. Refer to the following PM replacement if a new PM is fitted.

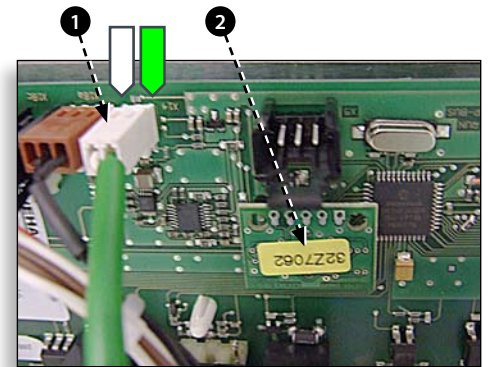
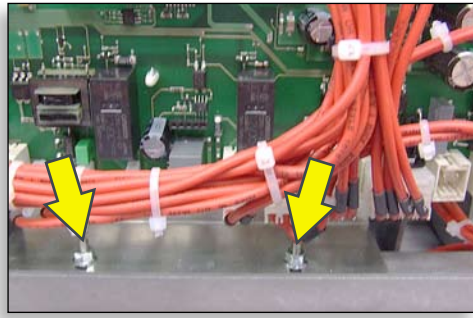

### 19.2 BTS replacement

- 19.2.1 Disconnect and isolate the oven from the electricity supply.
- 19.2.2 Allow the oven to cool down.
- 19.2.3 Remove the oven casing.
- 19.2.4 Ensure that the High Voltage Capacitor is discharged before commencing work.
- 19.2.5 Remove the top front panel.
- 19.2.6 Taking anti-static precautions, disconnect all connections on the BTS.
- 19.2.7 Remove the PM (Personality Module) (3) from the BTS and place safely aside.
- 19.2.8 Release the four retaining nuts and remove the BTS assembly (4).
- 19.2.9 Refit the PM removed from the old BTS to the new BTS. Refer to the following PM replacement if a new PM is fitted.
- 19.2.10 Replace the BTS assembly and secure with the retaining nuts.
- 19.2.11 Reconnect all connections to the BTS, for details see 'BTS Terminal Locations' (Electrical Circuits section).

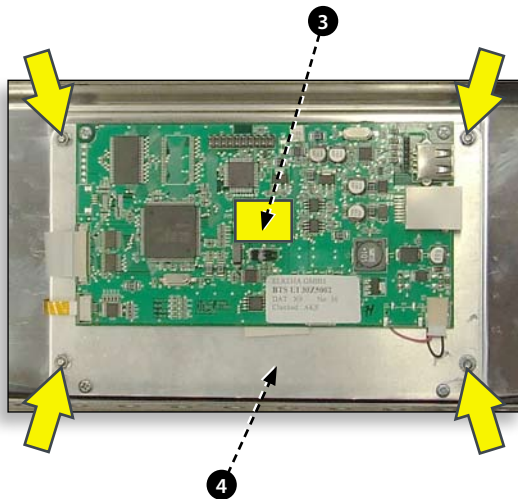

### 19.3 PM (Personality Module) replacement



The PM on the SRB contains the Firmware. The PM on the BTS contains the Firmware, Oven Serial Number, Temperature Calibration, Cooking Programs, Application Icons and the Recipe Images.

19.3.1 With a new PM fitted and casing refitted, switch on the oven and tap the screen to hold and check the BTS and SRB versions (1) are the latest release, if not, execute a Firmware update using the latest versions. For details see 'Firmware Updates' (Servicing section).

19.3.2 Tap the top right of the screen to bypass the preheat stage (2).

19.3.3 Enter the service password and select OK to display the Settings menu, see (3).

19.3.4 Select the USB symbol (4).

19.3.5 Slide the Merrychef badge upwards and insert the USB Memory Stick into the slot (5).

19.3.6 Once the USB has stopped flashing, select the required USB recipe symbol (6).

19.3.7 Select the Application Icons file to download (7). Note; a tinted band over a file name indicates the file is not valid for that oven.

19.3.8 Check the file information shown is correct before selecting OK (8), if not, select 'X' and locate the correct file.

19.3.9 When completed, select recipes to load the cooking programs (9). Once the programs are loaded the oven restarts.

19.3.10 Enter the Date & Time settings (10). For details see under 'Oven Control Settings' (Product Information section).

19.3.11 Turn the oven switch OFF/ON.

19.3.12 Remove the USB and keep in a safe place. Reposition the USB cover.

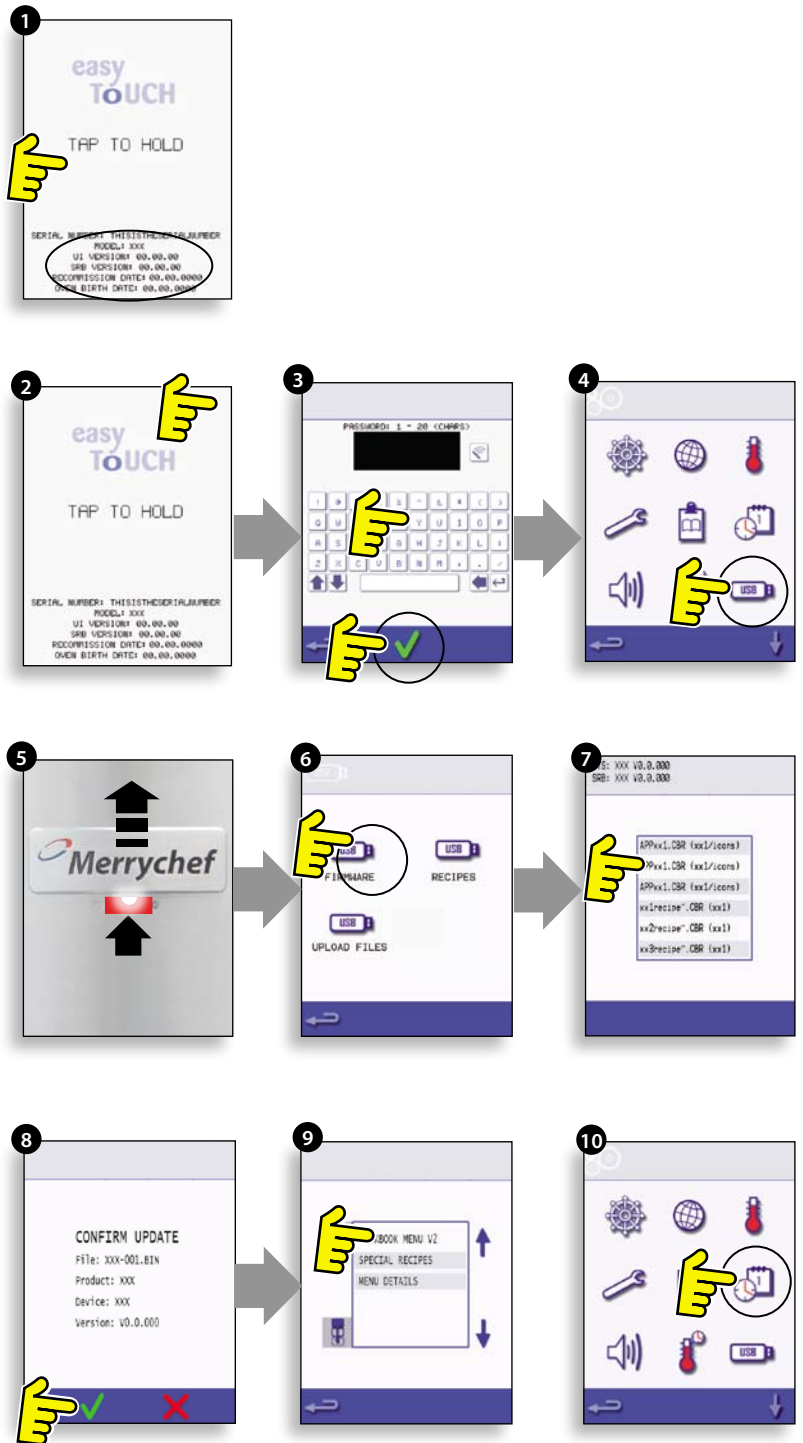

SPARES & REPLACEMENT

# 20 SPARE PARTS EXPLODED VIEW

SPARES & REPLACEMENT

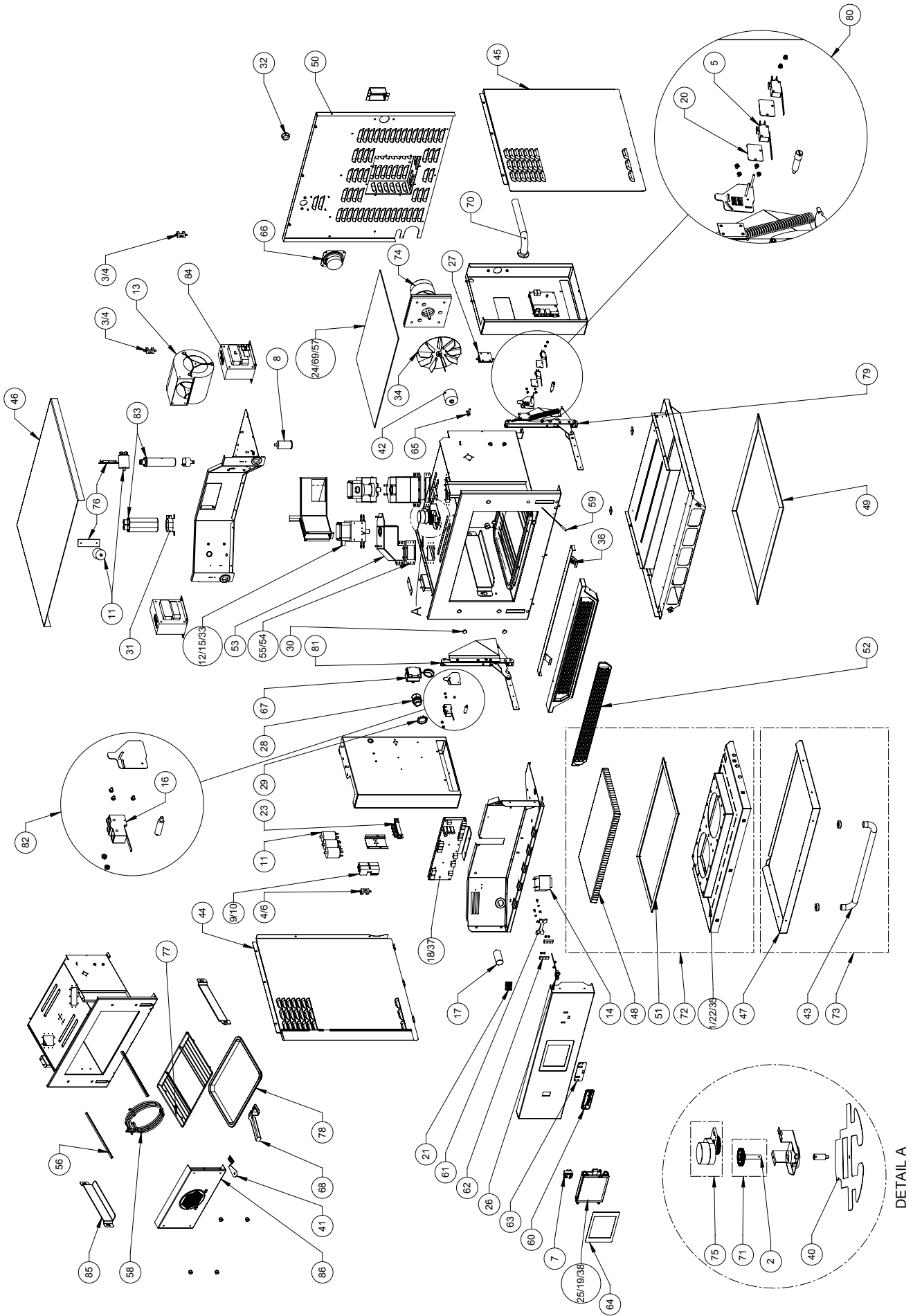



# 21 SPARE PARTS

## Parts list & recommended minimum stock holding & Service Kits

Exploded BOM No.	Part Number	Description	Qty Per Oven	Unit	1-10 Ovens	11-50 Ovens	51-100 Ovens	1st Aid/ To Go Box	Service Centre Kit
1	105005	M3 CAGE NUT	7	EA	7	21	42		
2	2741021	CERAMIC SHAFT	1	EA	1	3	6		1
5	30Z0240	MICROSWITCH	2	EA	2	6	12	2	4
7	30Z0503	SWITCH ON/OFF ROCKER DPST	1	EA	1	3	6	1	1
9	30Z1177	20 AMP LITTLEFUSE FLM020	2	EA	2	6	12	2	4
10	30Z1178	30A FUSE HOLDER	2	EA	1	3	6	1	2
11	30Z1340	FILTER 16A SCREW MOUNT	5	EA	2	6	12	1	4
12	30Z1415	MAGNETRON 2M303H	2	EA	1	3	6	1	2
13	30Z1423	500 BLOWER SINGLE FAN (MAGNETRON)	1	EA	1	3	6		1
15	30Z1427	MAGNETRON OVERHEAT STAT	2	EA	1	3	6	1	1
16	30Z1430	MICROSWITCH (LARGE)	1	EA	1	3	6	1	1
18	30Z5000	SMART RELAY BOARD SRB	1	EA	1	3	6		1
19	30Z5002	TOUCH SCREEN & PCB	1	EA	1	3	6		1
20	31Z0115	INSULATOR PAD	2	EA	2	6	12		
21	31Z0630	3-WAY TERMINAL BLOCK	2	EA	2	6	12		1
22	31Z0186	SILASTIC BLACK (DOOR SEAL)		TUBE	1	3	6	1	1
23	31Z0477	4 WAY MAINS TERMINAL BLOCK	1	EA	1	3	6		1
24	31Z0527	SILASTIC RED (STIRRER GLASS)		TUBE	1	3	6	1	1
25	31Z0599	BTS UI SRB CABLE (WHITE)	1	EA	1	3	6	1	1
26	31Z0600	USB ADAPTOR MODULE	1	EA	1	3	6		1
27	31Z0624	e5 MTR GOLD RESISTOR ASS	1	EA	1	3	6		1
28	31Z1255	PG21 CABLE GLAND BLACK	1	EA	1	3	6		
29	31Z1256	PG21 CABLE GLAND NUT	1	EA	1	3	6		
30	31Z1259	SHEET COVER CAP 12MM DIA	6	EA	6	18	36		
31	31Z1261	CAPACITOR CLIP UNIVERSAL	2	EA	2	6	12		
32	31Z1307	ETHERNET HOLE PLUG	1	EA	1	3	6		
33	31Z4016	M5 FLANGE NUT	55	EA	55	165	330		
34	31Z4041	FAN BLADE	1	EA	1	3	6		
35	31Z7013	ADHESIVE (LOCK 499)		TUBE	1	3	6		1
36	31Z7086	REED SWITCH RETAIN CLIP	1	EA	1	3	6		1
37	32Z7063	PERSONALITY MODULE SRB e5	1	EA	1	3	6		1
38	32Z7066	PERSONALITY MODULE BTS e5	1	EA	1	3	6		1
39	40C0864	SHELF SUPPORT CTM3 EUROPE	2	EA	2	6	12		
40	40C1007	STIRRER BLADE HI DISTRIBUTION	1	EA	1	3	6		1
41	40C1083	CLEANING SCOOP	1	EA	0	1	2		
42	40C1217	WAVE TRAP (HOT AIR MOTOR)	1	EA	0	1	2		
43	40C1305	DOOR HANDLE	1	EA	1	3	6		
44	40C1312	SIDE PANEL LH	1	EA	0	1	2		
45	40C1313	SIDE PANEL RH	1	EA	0	1	2		
46	40C1314	TOP PANEL OUTER	1	EA	0	1	2		
47	40C1317	DOOR SKIN	1	EA	0	1	2		
48	40C1340	DOOR CHOKE PLATE	1	EA	0	1	2		
49	40C1344	BASE SEAL 1-PIECE	1	EA	1	3	6		
50	41C0001	BACK PANEL ASSY	1	EA	0	1	2		
51	41C0003	500 DOOR SEAL KIT	1	EA	1	3	6	1	1
52	41C0004	AIR FILTER ASSY	1	EA	1	3	6	1	1
53	790048	WAVEGUIDE	2	EA	1	3	6		1
54	790049	WAVEGUIDE GASKET	2	EA	1	3	6		1
55	790050	WAVEGUIDE SEALING PLATE	2	EA	1	3	6		1
56	790052	RED SILICON SEAL LH/RH	1	MT	1	3	6	1	1
57	790053	RED SILICON SEAL FRONT/REAR	1	MT	1	3	6		1

SPARES & REPLACEMENT

Exploded BOM No.	Part Number	Description	Qty Per Oven	Unit	1-10 Ovens	11-50 Ovens	51-100 Ovens	1st Aid/ To Go Box	Service Centre Kit
58	DR0005	4 COIL HEAT ELEMENT	1	EA	1	3	6		1
59	DR0006	REED SWITCH	1	EA	1	3	6	1	1
60	DR0007	MERRYCHEF BADGE	1	EA	1	3	6		
61	DR0008	MERRYCHEF BADGE SLIDER	1	EA	1	3	6		
62	DR0009	MERRYCHEF BADGE GUIDE	1	EA	1	3	6		
63	DR0010	MERRYCHEF BADGE SEAL	1	EA	1	3	6		
64	DR0011	TOUCHSCREEN OVERLAY	1	EA	1	3	6		1
65	DR0020	CAVITY TEMP SENSOR (OVEN)	1	EA	1	3	6	1	1
66	DR0021	HARMONISED SPEAKER	1	EA	1	3	6		1
67	DR0043	OVERHEAT STAT LARGE	1	EA	1	3	6	1	1
68	MC3215	OVEN TRAY HANDLE	1	EA	1	3	6		
69	P11C0319	STIRRER GLASS ASSY	1	EA	1	3	6	1	1
70	P11C0498	STEAM PIPE WRAPPED ASSY	1	EA	1	3	6		
71	P11C0537	THV2 STIRRER GEAR & SHAFT	1	EA	1	3	6		1
72	P11C0578	DOOR FRAME ASSY HARM	1	EA	0	2	4		
73	P11C0579	DOOR OUTER COVER ASSY	1	EA	0	1	2		
74	P10C0316	HOT AIR MOTOR ASSY	1	EA	1	3	6		1
75	P11C0593	STIRRER MOTOR ASSY	1	EA	1	3	6		1
76	30Z5008	DIODE PCB ASSY	2	EA	2	6	12	2	2
77	RBR186X01	MEALSTREAM WIRE RACK	1	EA	1	3	6		
78	RBR290X02	OVEN TRAY	1	EA	1	3	6		
79 / 81	PSR101	EIKON DOOR HINGE KIT	1	EA	1	3	6		1
80 / 82	PSR102	EIKON M/SWITCH BRACKET KIT	1	EA	1	3	6		1

**eikon e5 - 208V & 240V 60Hz USA CAT - Unique Parts**

98	30Z1230	60HZ TRANS MULTI TAP	2	EA	2	6	12		2
99	30Z1330	0.88uF 2500V CAPACITOR	2	EA	2	6	12	2	2
100	40C1112	TIM HORTONS RACK SUPPORT	2	EA	0	1	2		
101	P11C0540	CATALYTIC CONVERTOR ASSY	1	EA	0	1	2		
102	SR209	POWER SUPPLY LEAD DG 3P (USA)	1	EA	1	3	6		
3	30Z1445	10A UL Fuse	2	EA	2	6	12	2	4
4	30Z0285	Fuseholder 1 1/4in	3	EA	1	3	6	1	3
6	30Z1444	7A UL Fuse	1	EA	2	6	12	2	4
8	30Z1448	6uf UL Starter cap	1	EA	1	3	6	1	1
17	30Z1447	2.5uf UL Starter cap	1	EA	1	3	6	1	2
14	30Z1455	LV TRANSFORMER	1	EA	1	3	6	1	2

## 22 ERROR CODES DISPLAYED

Error Code	Error Condition	Description	Trigger	Possible Causes	Error Level	System Response
E 101	Magnetron failed to energise	Detects a magnetron is not working correctly	The current measured by the current sensing transformer was outside of tolerance.	Failure of component/s in the microwave circuit	Critical	Display error message until system is power cycled.
E 102	Heater incorrect current	Detects a heating element is not working correctly	The current measured by the sensing transformer on the SRB was <1A when heating cycled on or >1A when heating cycled off.	If some current >1A, one or more heater elements could have failed. If current measured <1A possible wiring fault stopping power reaching element.	Critical	Display error message until system is power cycled.
E 103	Ambient overheat >70°C	Detects if the controls area is operating above temperature	The ambient temperature measured on the BTS and SRB was >70°C	Cooling fan failed. Cooling fan wired incorrectly. Inlet air too hot. Blocked inlet filter.	Critical	Display error message until ambient controls area temperature is below 60°C
E 104	Magnetron / Cavity Overheat	Detects if the cavity and magnetrons are above temperature	Cavity and magnetron overheat thermostats	Cooling fan failed. E103 / E106 not triggering. Failed SRB. Magnetron failure. Wiring / connection fault. Blocked Inlet filter.	Critical	Display error message until service call and the magnetron cools down or the cavity stat is reset.
E 105	Supply voltage high / low	Detects if the power supply voltage is outside specification	The power supply to the oven voltage sensor on the SRB measures too high / low	Incorrect mains voltage. Poor internal / external wiring connections. Faulty SRB.	Critical	Display error message until system power cycled.
E 106	Cavity reaches 25°C above setpoint once it has been controlling at setpoint	Detects if the cavity temperature has risen above limits	The setpoint of the oven was exceeded	Cavity fire. Failed convection fan. No impeller or loose impeller on convection fan.	Critical	Display error message until system is power cycled.
E 107	Communication error	No communication can be made between the BTS and SRB	Loss of communication between the SBR and BTS	SRB / BTS connection cable unplugged or damaged. Faulty BTS or SRB.	Critical	Display error message until system is power cycled.
E 108	BTS PM error	Wrong PM found / no PM found	The BTS or SRB either has an incorrect PM (Personality Module) fitted or no PM is fitted	The PM has been changed and is incorrect. The PM has been removed.	Critical	Display error message until system is power cycled.

Error Code	Error Condition	Description	Trigger	Possible Causes	Error Level	System Response
E 110	SRB version conflict	SRB firmware version incompatible with BTS version	The BTS has found that the firmware running the SRB is not supported.	Firmware update has been carried out to the BTS and the SRB has not been updated to match.	Critical	Display error message until system is power cycled.
E 111	Cavity sensor error	Cavity sensor broken / unplugged	The controller is reading an open circuit across the thermocouple input	The thermocouple is not connected. The thermocouple is broken open circuit. Failed SRB.	Critical	Display error message until system is power cycled.
E 112	Fan not running or low speed	Detects the fan speed	Less than 30 revolutions per second	No or low motor voltage. Wiring malfunction.	Critical	Display error message until system is power cycled.
N/A	Oven door open longer than 1 min.	Oven door open. Oven inoperable.	Break in switched feed on SRB	Door left open. Failed door switch/s or SRB. Faulty wiring or connection.	Warning	Display warning message until door is closed.
N/A	Air Filter removed	Air filter not fitted. Oven inoperable.	Filter not fitted.	Failed reed switch/s or SRB. Faulty wiring or connection.	Warning	Display error message until filter replaced.

## 23 SRB & BTS Circuit Boards

### 23.1 BTS LEDs

- Run - Pulsing 1 second flash, indicating that the board has booted up.
- Power - Lit to show that there is a power supply from the SRB.
- P-Bus - Irregular flashing, indicating data communication with SRB.
- C-Bus - Lit to show data being loaded from the PM onto the BTS.
- LD5 - Lit to show.

1 LD5

2 Power, Run, P-Bus, C-Bus.

### 23.2 BTS Terminal Locations

3 X6 - Speaker

4 X5 - USB socket

5 X4 - Communications to SRB

6 X11 - Screen backlight

7 X13 - Touch pad

8 X9 - Display Screen PCB

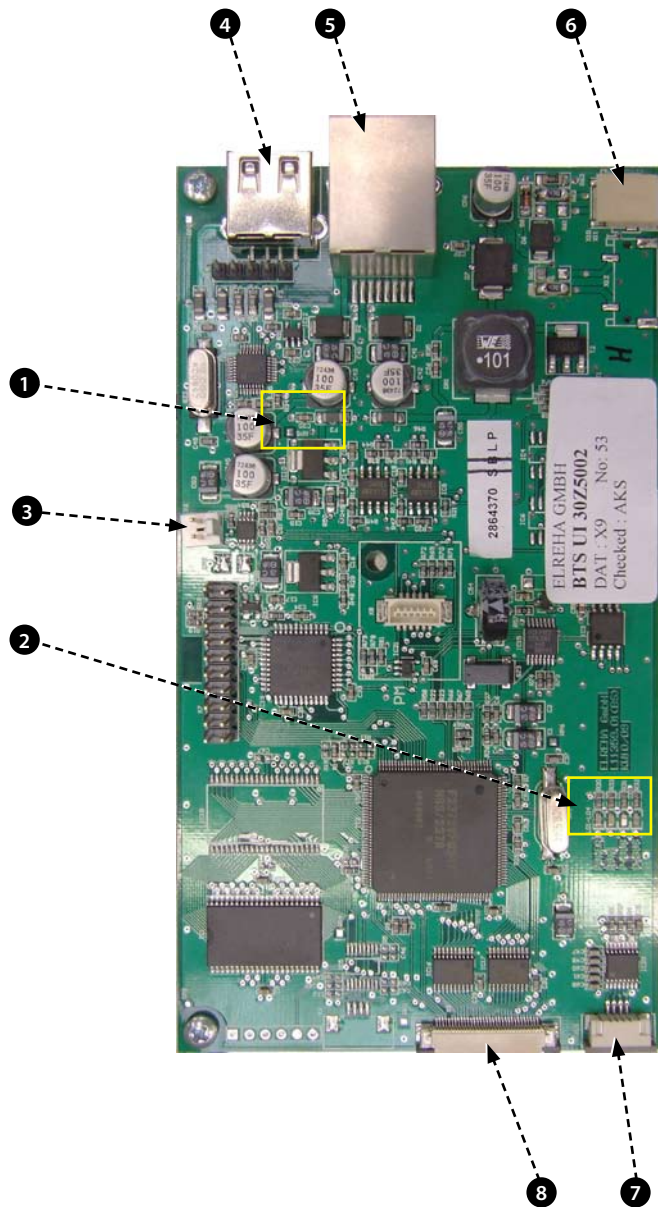



### 23.3 SRB LED's

- P-Bus - Irregular flashing, indicating data communication with BTS.
- Run - Pulsing 1 second flash, indicating that the board has booted up.
- 12v & 5v - Lit to show voltage outputs from inboard transformer.
- Relay & Triac - Lit to show that a signal has been sent to energise that component.

- 1 Cooling fan.
- 2 Convection fan.
- 3 Stirrer.
- 4 5v supply.
- 5 12v supply.
- 6 Heater safety.
- 7 Heater drive.
- 8 P-BUS: flashes when data is being sent / received. RUN: 1 second flash.
- 9 Oven Door.
- 10 Microwave safety relay.
- 11 Microwave 2 drive.
- 12 Microwave 1 drive.

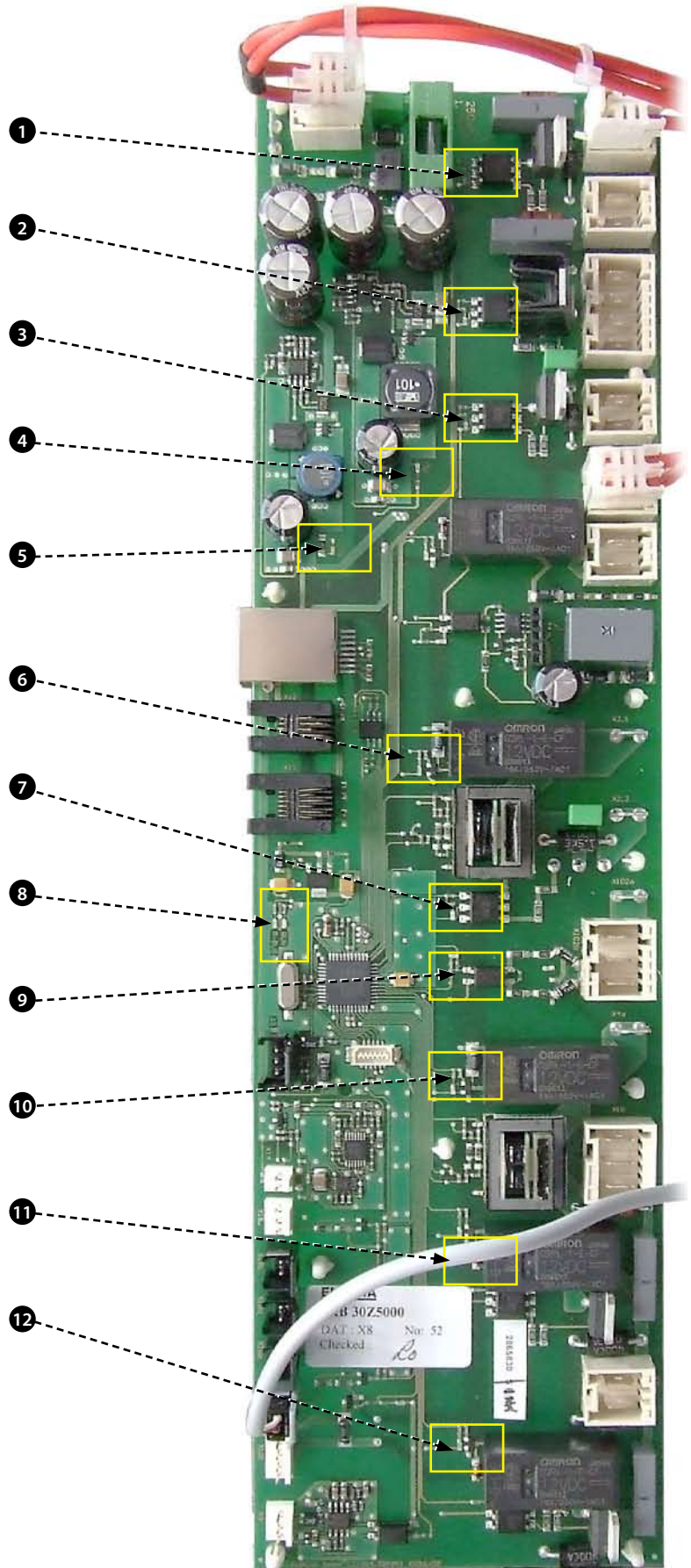



### 23.4 SRB Terminal Locations:

- 1 X3 - Not used.
- 2 X101 - Voltage Selection Relay coil feeds.
- 3 X18b - Air intake Filter Reed Switch.
- 4 X18e - Right Magnetron Overheat Thermostat.
- 5 X18d - Left Magnetron Overheat Thermostat.
- 6 X18c - Cavity Overheat Thermostat.
- 7 X18a - On/Off Switch.
- 8 X14 - Cavity Temperature Thermocouple.
- 9 X5 - Fan RPM Input (not used).
- 10 X13 - P Bus, Ethernet Port.
- 11 X12 - C Bus, Development PC Port.
- 12 X11 - P/C Bus, BTS Cable.
- 13 X1 - 24V supply from Low Voltage Transformer.
- 14 X8 - Cooling Fan.
- 15 X17 - Mains Output, Convection Fan.
- 16 X20 - Microwave Stirrer motor.
- 17 X9 - Not Used.
- 18 X103.1 - Mains Output to Low Voltage Transformer.
- 19 X103 - Mains Input, Live & Neutral.
- 20 X2.1 - Mains Input, Live for Heaters.
- 21 X2.2 - Mains Output, Live to Heaters.
- 22 X102a - Mains Input, Neutral for Magnetron Transformers & Monitor Door Switch.
- 23 X102b - Mains Output, Neutral to Magnetron Transformers & Monitor Door Switch.
- 24 X4a - Door Switch signal from Secondary Door Switch (Live for Magnetron Transformers).
- 25 X10 - Connector Block for door switches.
- 26 X4b - Live for Magnetron Transformers.

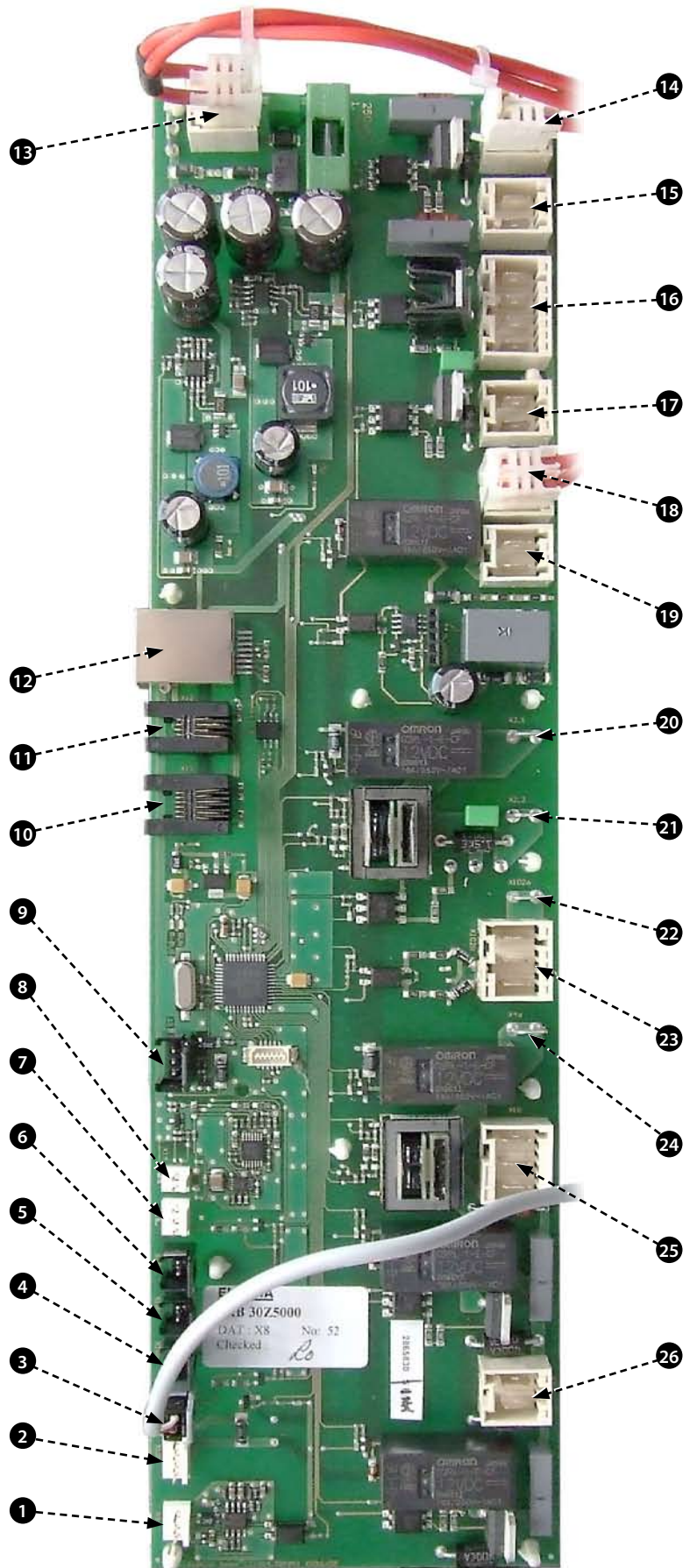

# 24 CIRCUIT DIAGRAM

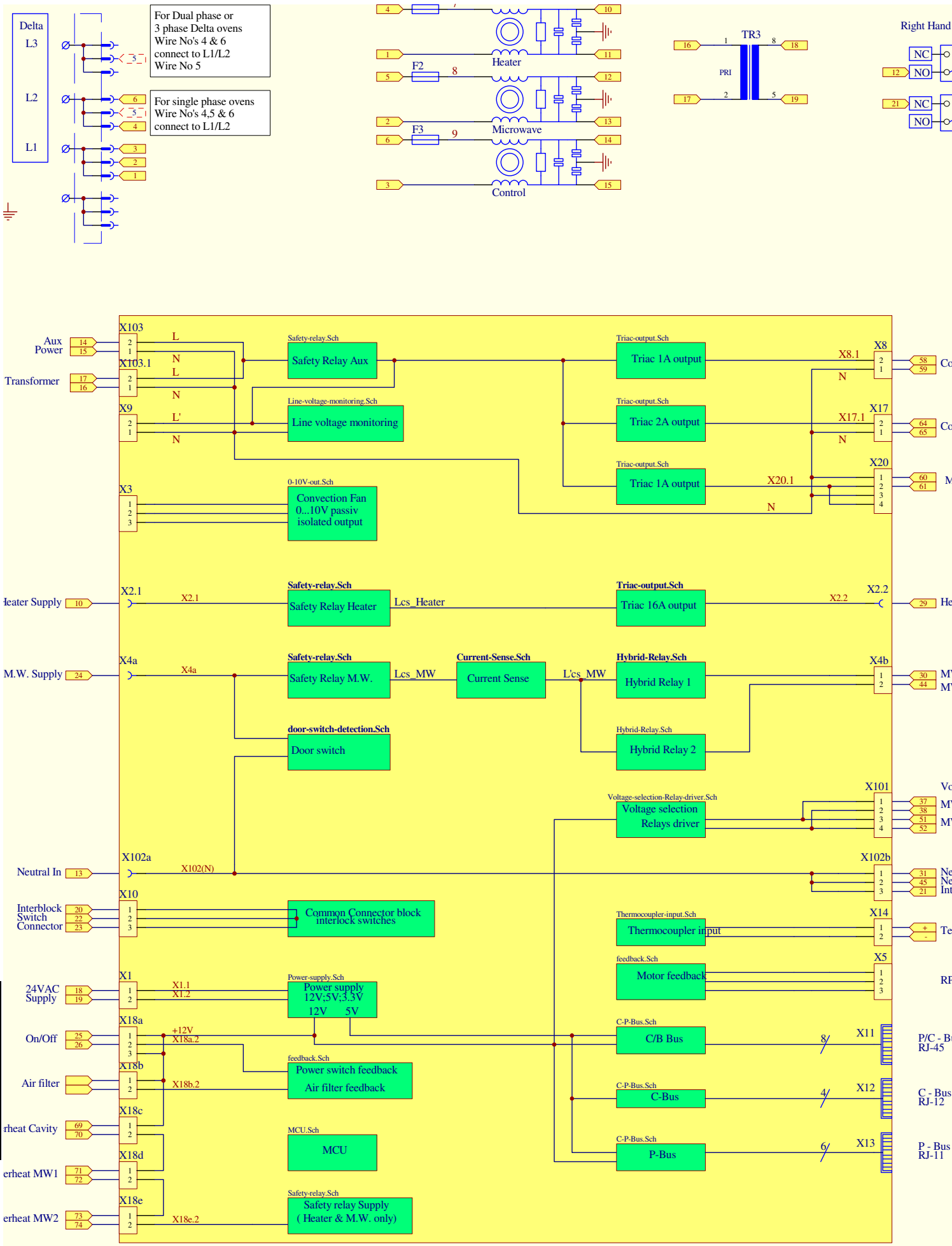

ELECTRICAL CIRCUITS

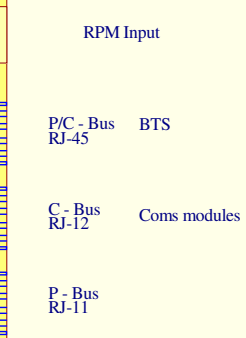
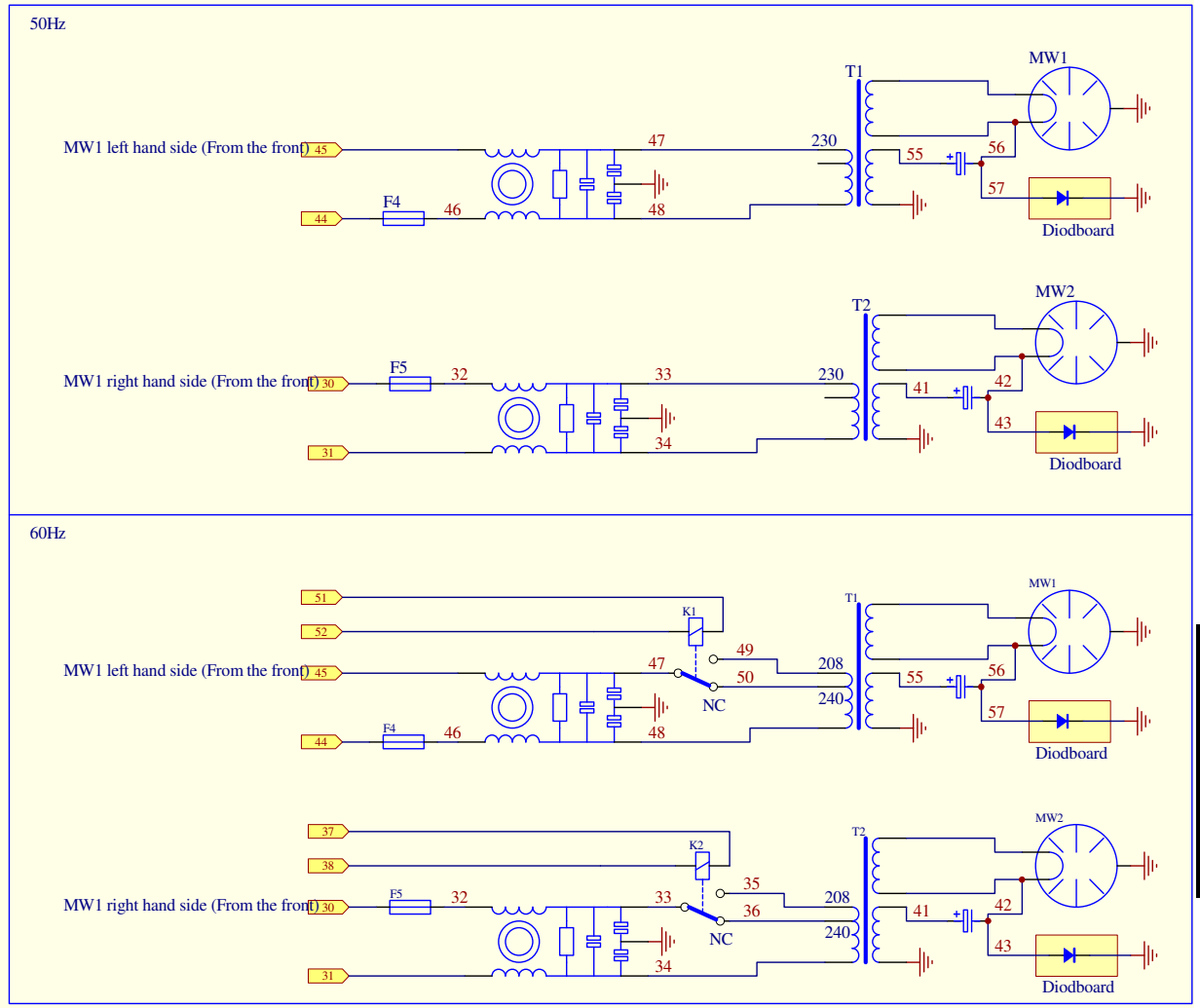
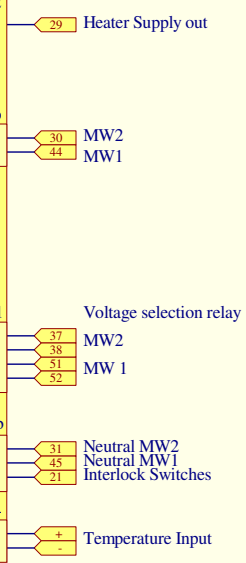
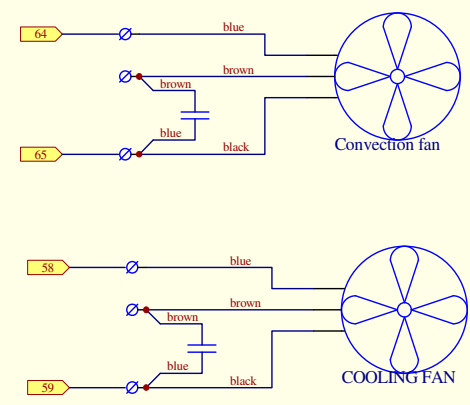
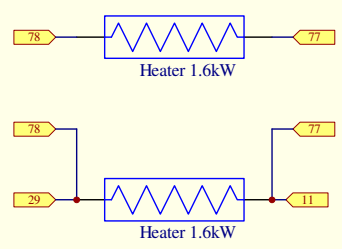
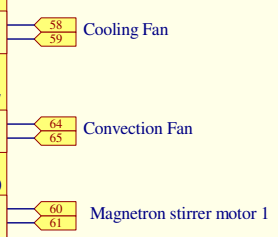
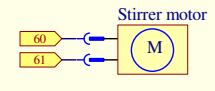
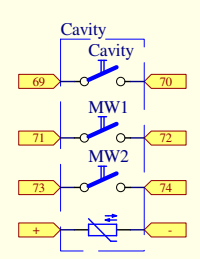
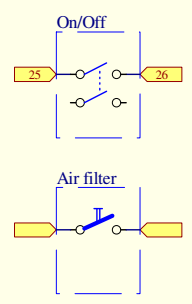
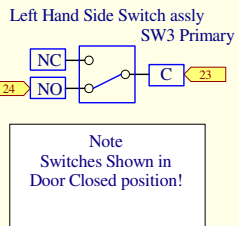
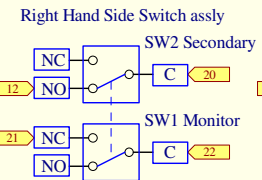

ELECTRICAL CIRCUITS

## 24.1 POWER CONNECTIONS e5

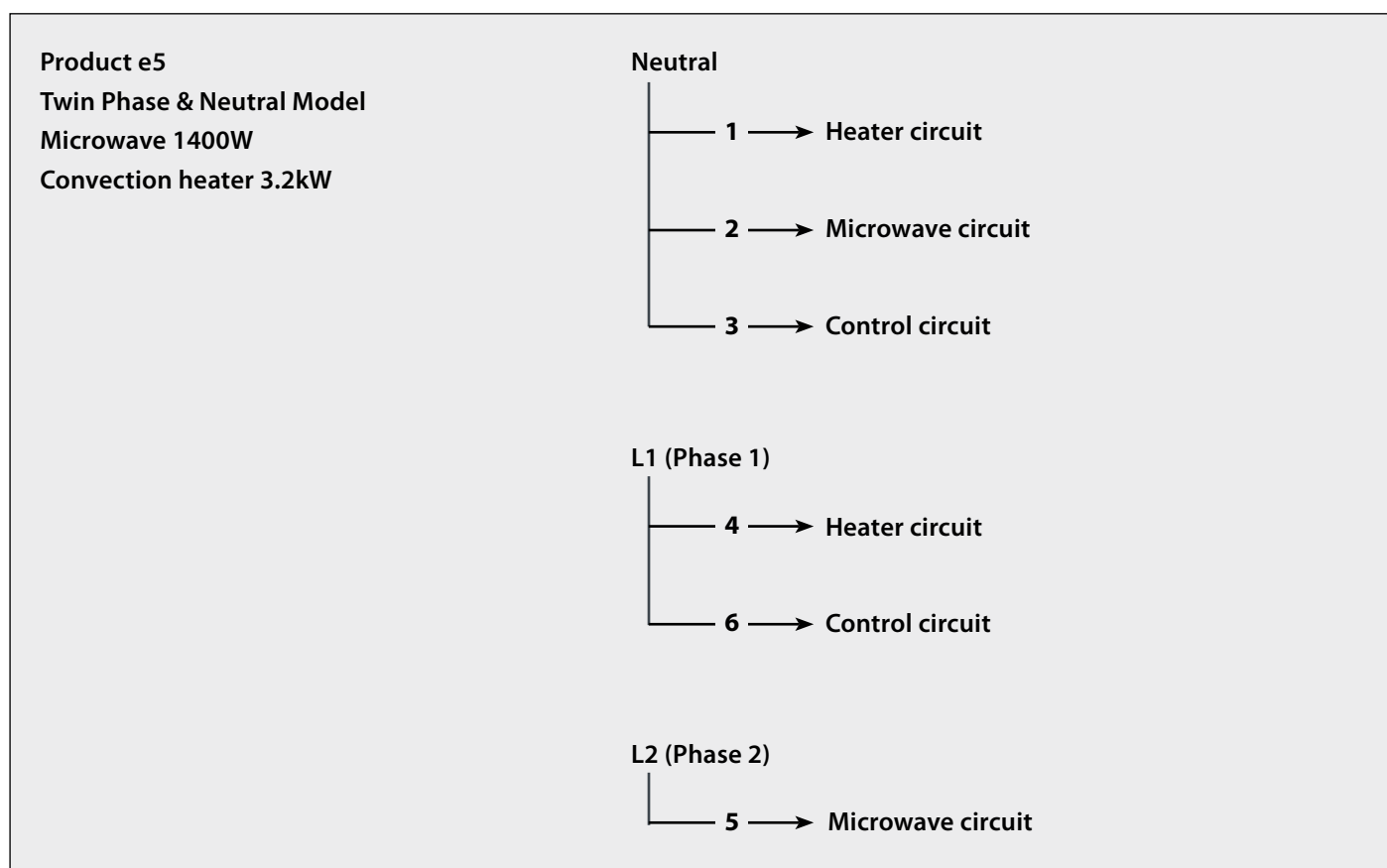
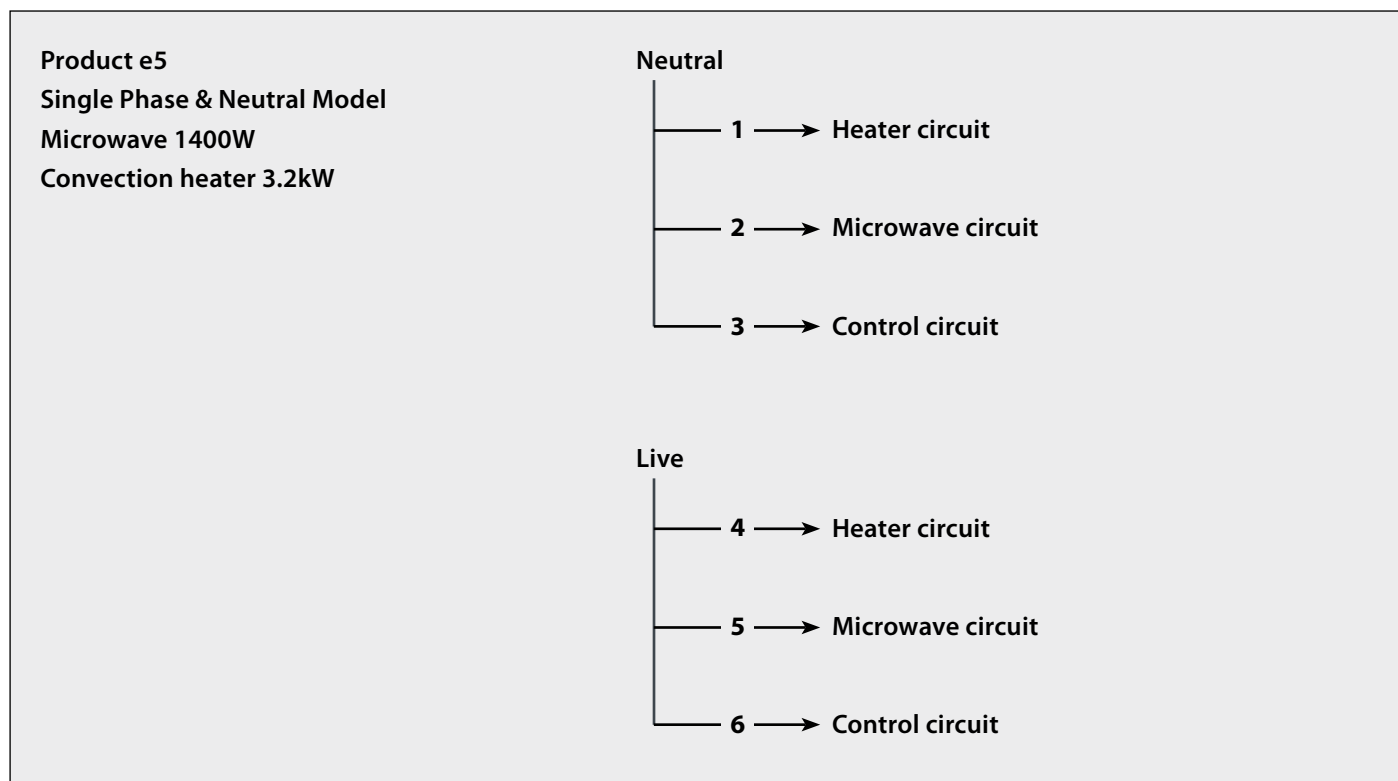

## 24.2 CONTROL CIRCUIT e5

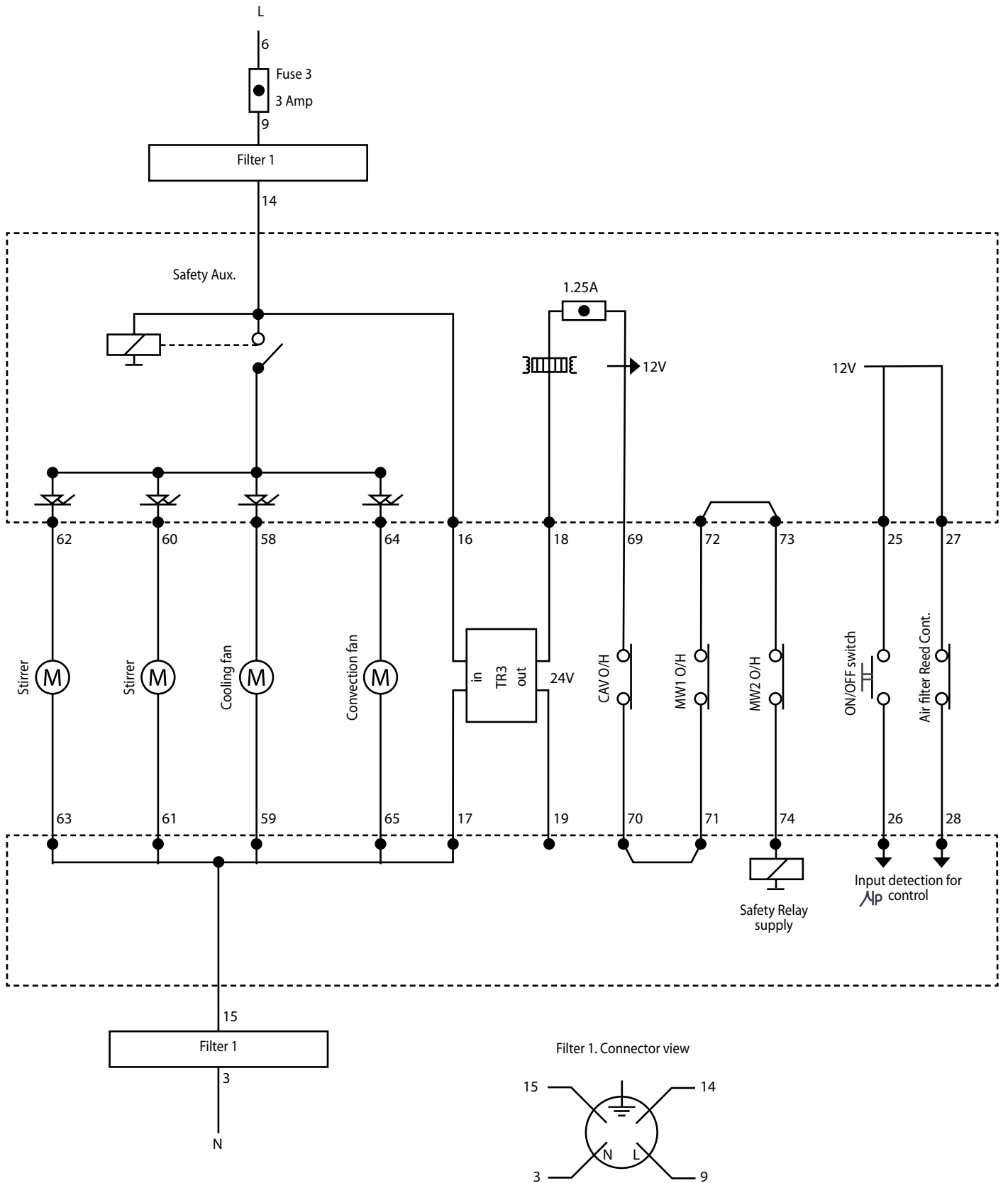

## 24.3 HEATER CIRCUIT e5

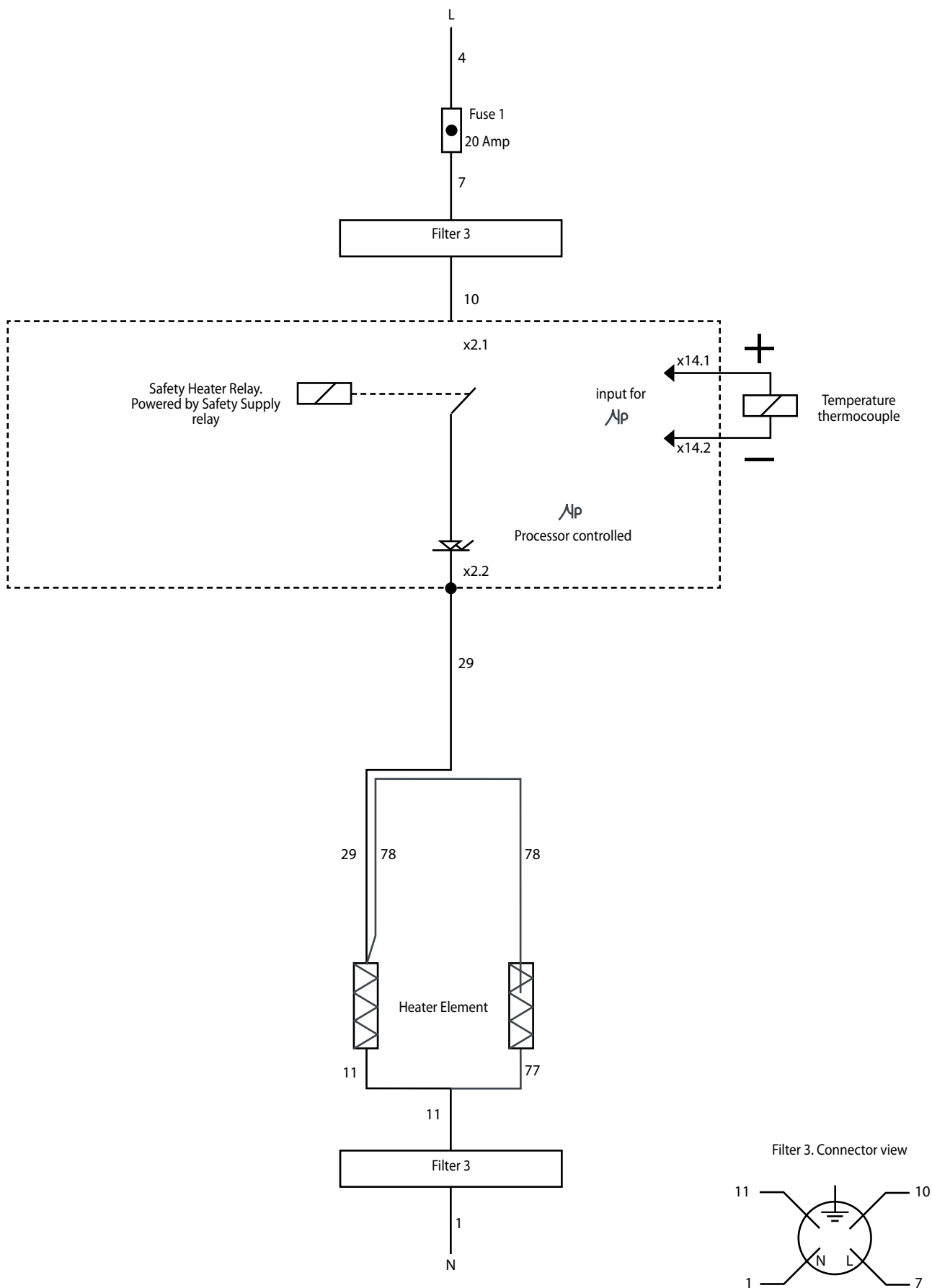



## 24.4 MICROWAVE CIRCUIT e5

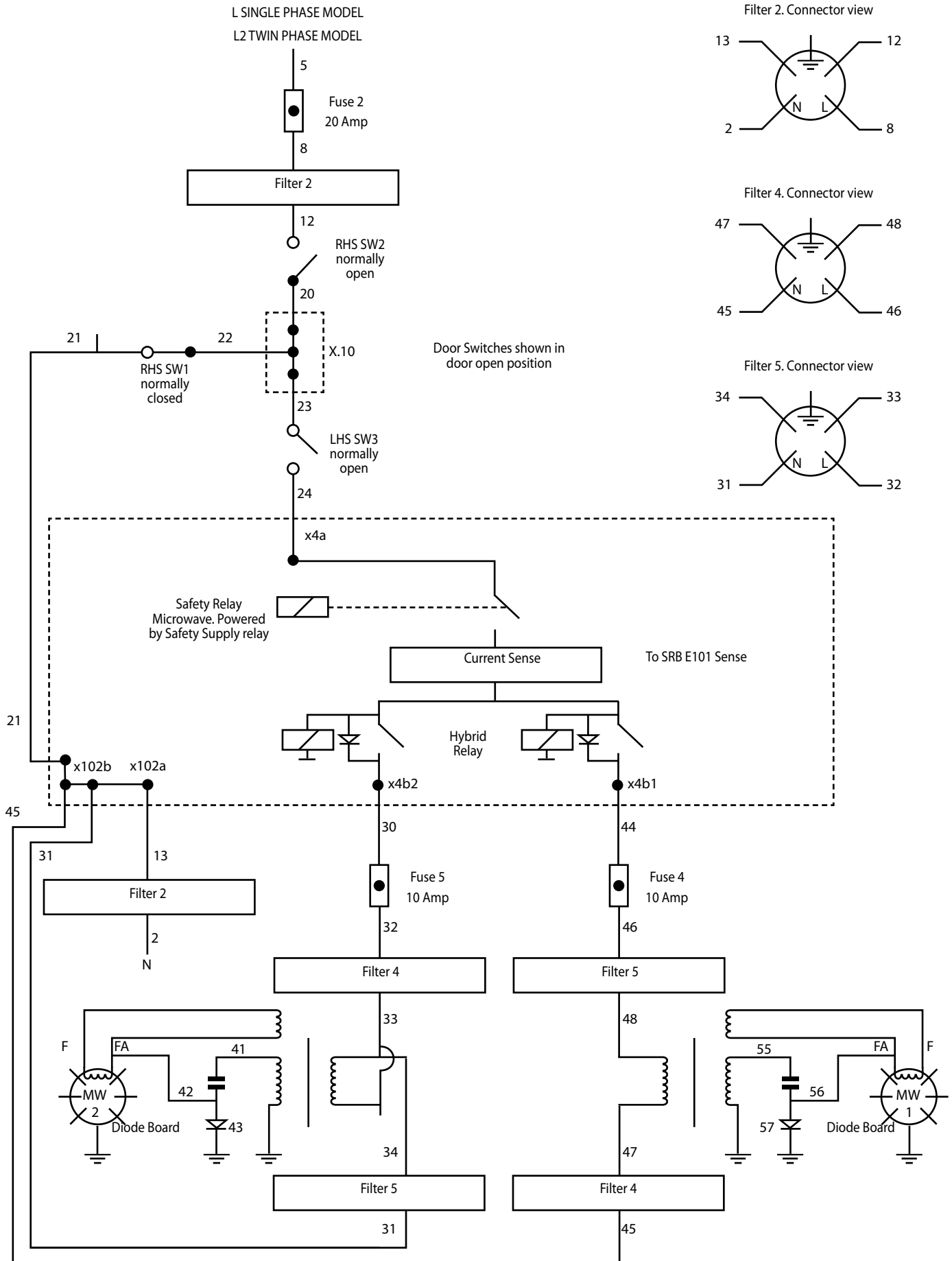

## 25 Commissioning the oven

---

### 25.1 Initial installation

- 1 Unpack the Oven and check for damage.
- 2 Check Oven Accessories.
- 3 Check location will provide adequate Ventilation.
- 4 Locate Oven onto a strong, level, non-flammable Surface.
- 5 Remove panels & check all wiring and components for security.
- 6 Refit panels.
- 7 Position the Oven with a minimum air gap of 50mm, sides & rear.
- 8 Check Electrical supply and connect.
- 9 Place a container of water within the oven and switch it on.
- 10 Record Model version & check against serial plate.
- 11 Record BTS (UI) version.
- 12 Record SRB version.
- 13 Record Serial Number & check against serial plate.
- 14 Enter Service Mode.
- 15 Record Voltage & Frequency.
- 16 Record Magnetron Current Draw.
- 17 Check for Microwave leakage.
- 18 Record Heater current.
- 19 Check door opening on display.
- 20 Check filter removal on display.
- 21 Check fan speed.
- 22 Turn off the oven and remove the water.
- 23 Switch on oven and run up to temperature.
- 24 Operate Oven, Cooking a Standard Batch.
- 25 Supply User information & contact details to Customer.
- 26 Instruct Users with an Overview of the equipment, Operation & Safety (Hazards).
- 27 Complete Service Report.

### 25.2 After Service

**Complete the following checks after the Oven has been Serviced/Repaired/Tested before connecting to the mains electricity power supply:**

- 25.2.1 All internal electrical connections are correct (see wiring diagrams).
  - 25.2.2 All wiring insulation is correct and is not touching any sharp edges.
  - 25.2.3 All grounding connections are electrically and mechanically secure.
  - 25.2.4 All door safety interlocks are secure and mechanically sound.
  - 25.2.5 The door activates all of the door interlock switches and in the correct order.
  - 25.2.6 The door operation is smooth, and the arms run freely in the slots.
  - 25.2.7 The temperature sensor is correctly connected to the SRB.
  - 25.2.8 The casing is securely refitted with no trapped wires.
- Before finishing a service call, recheck the following points:**
- 25.2.9 Run the Recommission tests to ensure the oven is functioning correctly and the touch screen is working.
  - 25.2.10 Microwave emissions are below permissible limit of  $5\text{mW}/\text{cm}^2$ .
  - 25.2.11 The power output of the oven is checked in accordance with the procedure.
  - 25.2.12 The oven has correct 50mm (2 inches) air gap all round and 50mm (2 inches) above. Air flow should not be restricted.
  - 25.2.13 Complete the Service Report.



---

### Correct disposal of this product (Waste Electrical & Electronic Equipment)



To prevent possible harm to the environment or human health from uncontrolled waste disposal, please separate this from other types of wastes and recycle it responsibly to promote the sustainable reuse of material resources.

Household users should contact either the retailer where they purchased this product, or their local government office for details of where and how they can take this item for environmentally safe recycling.

Business users should contact their supplier and check the terms and conditions of the purchase contract. This product should not be mixed with other commercial wastes for disposal.



Merrychef USA

1111 North Hadley RD

Fort Wayne

IN 46804 USA

Phone: 877/404 - 6872

Fax: 800/285 - 9511

e-mail: [info@merrychefusa.com](mailto:info@merrychefusa.com)

[www.merrychefusa.com](http://www.merrychefusa.com)

Merrychef reserves the right to change product specifications without notice and accepts no liability for any inaccuracies, errors or omissions contained herein.