

MERRYCHEF eikon SERIES OVENS

SERVICE PARTS LISTS

Tab 1	Merrychef eikon e2 [50Hz / 60Hz - 13A - 16A - 20A Models]	Pages 2 to 8
Tab 2	Merrychef eikon e2s [50Hz / 60Hz - 13A - 15/16A - 30A Models]	Pages 9 to 21
Tab 3	Merrychef eikon e3 [50Hz / 60Hz - EE - XE & XX Models]	Pages 22 to 26
Tab 4	Merrychef eikon e4 [50Hz / 60Hz Models]	Pages 27 to 34
Tab 5	Merrychef eikon e4s [50Hz / 60Hz Models]	Pages 35 to 38
Tab 6	Merrychef eikon e5 [50Hz / 60Hz Models]	Pages 39 to 42
Tab 7	Merrychef eikon e6 [60Hz Model]	Pages 43 to 45

Merrychef eikon e2 Oven - Exploded View

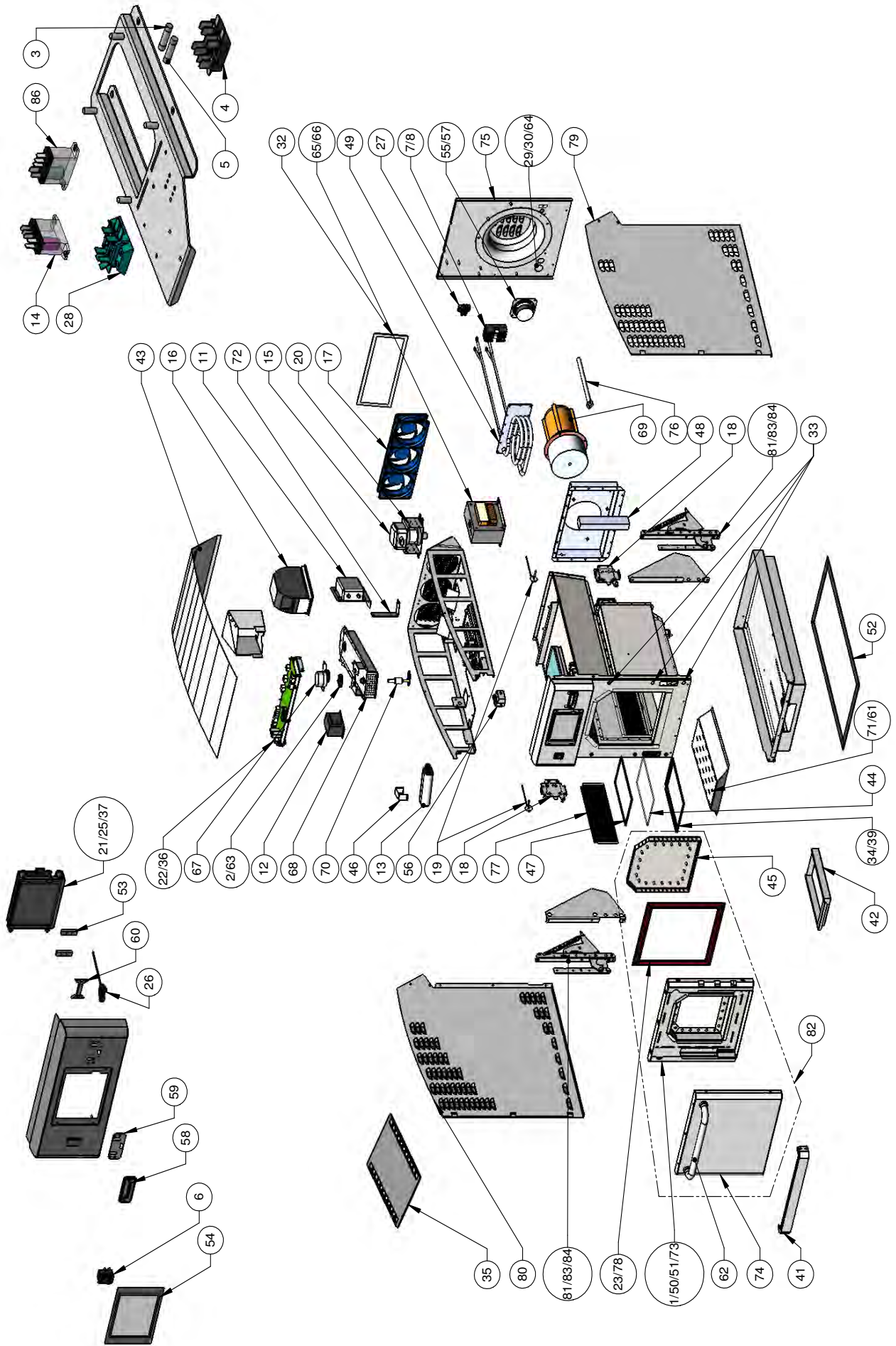

SPARES & REPLACEMENT

Merrychef eikon e2 Oven

Recommended Parts List

Recommended Min Stock Holding & Service List

Service Manual Exploded View	Part Number	Description	Qty Per Oven	Unit	1-10 Ovens	11-50 Ovens	51-100 Ovens	Recommended Service List
1	31Z4046	M3 CAGE NUT	7	EA	7	21	42	
1-50-51-73-78	PSJ225	INNER DOOR ASSY e2	1	EA	1	3	6	
2	2175164	3/32 X 3/4 SLIT PIN	1	EA	1	3	6	
6	30Z0503	SWITCH ON/OFF ROCKER DPST	1	EA	1	3	6	1
15	P30Z1472	MAGNETRON	1	EA	1	3	6	1
16	30Z1473	MTR SPEED CONTROLLER e2	1	EA	1	3	6	
18	30Z1477	e2 MICROSWITCH SHORT ARM	3	EA	3	9	18	3
18 x2	PSJ160	e2 DOOR MICROSWITCH KIT	1	EA	1	3	6	
20	30Z1480	e2/e6 MAG HI LIMIT STAT	1	EA	1	3	6	1
21	P30Z5009	TOUCH SCREEN PCB	1	EA	1	3	6	1
23	31Z0186	SILASTIC BLACK (DOOR SEAL)		TUBE	0	0	0	1
25	31Z0599	BTS UI SRB CABLE (WHITE)	1	EA	1	3	6	
26	31Z0600	USB ADAPTOR MODULE	1	EA	1	3	6	
28	31Z0652	2-WAY TERMINAL BLOCK	1	EA	1	3	6	
33	31Z1328	PLUG 1/2 INCH RND KICKEL	6	EA	6	18	36	
34	31Z1252	BOLT M4 X 10 HEX HD (PARTITION PLATE)	18	EA	18	54	108	
36	32Z7069	PERSONALITY MODULE e2 SRB	1	EA	1	3	6	1
37	32Z7072	PERSONALITY MODULE e2 QTS	1	EA	1	3	6	1
39	DJ0009	HORN COVER FRAME e2	1	EA	1	3	6	
41	DJ0024	UNDER DOOR COVER ASSY	1	EA	1	3	6	
42	DJ0063	DRIP PAN FINISHED e2	1	EA	1	3	6	
44 & 47	PSJ161	e2/e6 PARTITION PLATE KIT	2	EA	2	6	12	2
45	DJ0077	DOOR CHOKE PLATE	1	EA	1	3	6	
46	DJ0078	CAPACITOR CLIP e2	1	EA	1	3	6	
48	DJ0080	e2 CATALYST	1	EA	1	3	6	
49	DJ0081	e2 HEATER ELEMENT	1	EA	1	3	6	
50 & 51	SJ317	e2 DOOR INSULATION KIT V2	1	EA	1	3	6	
52	DJ0100	e2 BASE SEAL	1	EA	1	3	6	
53	DR0009	MERRYCHEF BADGE GUIDE	2	EA	2	6	12	
54	DR0011	TOUCHSCREEN OVERLAY	1	EA	1	3	6	1
55	DR0021	HARMONISED SPEAKER	1	EA	1	3	6	
56	DR0042	OVERHEAT SAFETY STAT	1	EA	1	3	6	1
57	DR0045	SPEAKER WIRE	1	EA	1	3	6	
58	DR0049	MERRYCHEF BADGE SMALL	1	EA	1	3	6	
59	DR0050	MERRYCHEF BADGE SEAL SM	1	EA	1	3	6	
60	DR0051	MERRYCHEF BADGE SLIDER SM	1	EA	1	3	6	
61	DV0370	LOWER IMPINGER HANDLE	1	EA	1	3	6	
62	DR0030	HANDLE SPACER	2	EA	2	6	12	
62	DV0431	DOOR HANDLE	1	EA	1	3	6	
63	DV0552	GEAR - STIRRER WHEEL	1	EA	1	3	6	
67	PSJ202	STIRRER MOTOR ASSY	1	EA	1	3	6	
68	SJ302	WAVEGUIDE ASSY e2	1	EA	1	3	6	
69	PSJ262	e2 CONVECTION MOTOR KIT	1	EA	1	3	6	1
70	PSJ204	e2 STIRRER ASSY	1	EA	1	3	6	
71 & 61	PSJ209	e2 JET PLATE ASSY	1	EA	1	3	6	
72	PSR109	DIODE REPLACEMENT KIT	1	EA	1	3	6	1
74	PSJ226	OUTER DOOR SKIN ASSY e2	1	EA	1	3	6	
76	SJ301	STEAM TUBE ASSY e2	1	EA	1	3	6	
77	SJ310	GREASE FILTER ASSY e2	2	EA	2	6	12	
78	PSJ313	DOOR GASKET	1	EA	1	3	6	1
81-83-84	PSJ152	e2 DOOR HINGE KIT	1	EA	1	3	6	1
82	PSJ153	e2 DOOR ASSY (COMPLETE)	1	EA	1	3	6	
Not Shown	30Z1457	eikon SRB 1.25V FUSE	1	EA	1	3	6	1
Not Shown	31Z1302	BADGE RETAINING SPRING	1	EA	1	3	6	
Not Shown	31Z1320	e2/e6 DOOR SWITCH SPACER	3	EA	3	9	18	
Not Numbered	DJ0054	CONTROL PANEL FINISHED	1	EA	1	3	6	
Not Shown	DJ0083	HORN QUARTZ	2	EA	2	6	12	
Not Shown	DX0094	SILICONE FOAM TAPE CUT	1	EA	1	3	6	
Not Numbered	SJ305	CAVITY ASSY e2	1	EA	1	3	6	
Not Shown	SJ318	e2 CAVITY INSULATION KIT V3	1	EA	1	3	6	

Merrychef eikon e2 Oven

Recommended Parts List

Recommended Min Stock Holding & Service List

Service Manual Exploded View	Part Number	Description	Qty Per Oven	Unit	1-10 Ovens	11-50 Ovens	51-100 Ovens	Recommended Service List
eikon e2 230Volts 50Hz 13A - UK - Unique Parts								
3	30Z0217	FUSE 1in 10A HRC	1	EA	1	3	6	1
4	30Z0231	FUSEHOLDER 1in (13A)	2	EA	2	6	12	
5	30Z0394	FUSE 1in 7A HRC	1	EA	1	3	6	1
6	31Z1250	MAINS ON/OFF SWITCH COVER	1	EA	1	3	6	
6	31Z1251	MAINS ON/OFF SWITCH BEZEL	1	EA	1	3	6	
7	30Z1177	20 AMP LITTLEFUSE FLM020	2	EA	2	6	12	2
8	30Z1178	30A FUSE HOLDER	2	EA	2	6	12	
11	30Z1482	e2 MAINS FILTER 20VT-1	1	EA	1	3	6	
12	30Z1455	TRANSFORMER LV CLASS 2	1	EA	1	3	6	1
13	30Z1431	1.2uF 2500V CAPACITOR	1	EA	1	3	6	1
14	30Z1440	RELAY 240V OMRON	1	EA	1	3	6	1
17	30Z1475	CABINET FAN e2 LRG	2	EA	2	6	12	
17	30Z1542	e2 FAN MOTOR AC 4300 H	1	EA	1	3	6	
19	SJ358	e2 CAVITY THERMOCOUPLE	1	EA	1	3	6	1
22	30Z5014	CONTROL PCB e2 SRB VDE	1	EA	1	3	6	1
27	31Z0651	3-WAY TERMINAL BLOCK	2	EA	2	6	12	
29	31Z1308	CABLE GLAND PG16	1	EA	1	3	6	
30	31Z1309	GLAND NUT PG16	1	EA	1	3	6	
32	SJ371	ROBUST AIR FILTER EU	1	EA	1	3	6	1
43	SJ325	e2 LID ASSY EU	1	EA	1	3	6	
64	P11M0339	MAINS CABLE ASSY	1	EA	1	3	6	
65	P30Z1413	230V 50Hz TRANSFORMER	1	EA	1	3	6	
75	SJ320	e2 BACK PANEL ASSY EU	1	EA	1	3	6	
79	SJ314	SIDE COVER RHS ASSY e2	1	EA	1	3	6	
80	SJ315	SIDE COVER LHS ASSY e2	1	EA	1	3	6	
Not Numbered	DJ0185	MAG FAN SHROUD MK2	1	EA	1	3	6	

eikon e2 230Volts 50Hz 13A Parent - UK - Unique Parts

3	30Z0217	FUSE 1in 10A HRC	1	EA	1	3	6	1
4	30Z0231	FUSEHOLDER 1in (13A)	2	EA	2	6	12	
5	30Z0394	FUSE 1in 7A HRC	1	EA	1	3	6	1
6	31Z1250	MAINS ON/OFF SWITCH COVER	1	EA	1	3	6	
6	31Z1251	MAINS ON/OFF SWITCH BEZEL	1	EA	1	3	6	
7	30Z1177	20 AMP LITTLEFUSE FLM020	4	EA	4	12	24	2
8	30Z1178	30A FUSE HOLDER	4	EA	4	12	24	
11	30Z1482	e2 MAINS FILTER 20VT-1	1	EA	1	3	6	
12	30Z1455	TRANSFORMER LV CLASS 2	1	EA	1	3	6	1
13	30Z1431	1.2uF 2500V CAPACITOR	1	EA	1	3	6	1
14	30Z1440	RELAY 240V OMRON	1	EA	1	3	6	1
17	30Z1475	CABINET FAN e2 LRG	2	EA	2	6	12	
17	30Z1542	e2 FAN MOTOR AC 4300 H	1	EA	1	3	6	
19	SJ358	e2 CAVITY THERMOCOUPLE	1	EA	1	3	6	1
22	30Z5014	CONTROL PCB e2 SRB VDE	1	EA	1	3	6	1
27	31Z0651	3-WAY TERMINAL BLOCK	2	EA	2	6	12	
29	31Z1308	CABLE GLAND PG16	1	EA	1	3	6	
30	31Z1309	GLAND NUT PG16	1	EA	1	3	6	
32	SJ371	ROBUST AIR FILTER EU	1	EA	1	3	6	1
43	SJ325	e2 LID ASSY EU	1	EA	1	3	6	
64	P11M0339	MAINS CABLE ASSY	1	EA	1	3	6	
65	P30Z1413	230V 50Hz TRANSFORMER	1	EA	1	3	6	
75	SJ320	e2 BACK PANEL ASSY EU	1	EA	1	3	6	
79	SJ314	SIDE COVER RHS ASSY e2	1	EA	1	3	6	
80	SJ315	SIDE COVER LHS ASSY e2	1	EA	1	3	6	
Not Shown	31Z0654	e2 UK PARENT SOCKET 13A	1	EA	1	3	6	
Not Shown	33Z0068	e2 PARENT EARTH WIRE	1	EA	1	3	6	
Not Shown	33Z0069	e2 PARENT FUSE TO FUSE	1	EA	1	3	6	
Not Shown	33Z0070	e2 PARENT FUSE TO SOCKET	1	EA	1	3	6	
Not Numbered	DJ0185	MAG FAN SHROUD MK2	1	EA	1	3	6	

Merrychef eikon e2 Oven

Recommended Parts List

Recommended Min Stock Holding & Service List

Service Manual Exploded View	Part Number	Description	Qty Per Oven	Unit	1-10 Ovens	11-50 Ovens	51-100 Ovens	Recommended Service List
eikon e2 230Volts 50Hz 16A - EU - Unique Parts								
3	30Z0217	FUSE 1in 10A HRC	1	EA	1	3	6	1
4	30Z0231	FUSEHOLDER 1in (13A)	2	EA	2	6	12	
5	30Z0394	FUSE 1in 7A HRC	1	EA	1	3	6	1
6	31Z1250	MAINS ON/OFF SWITCH COVER	1	EA	1	3	6	
6	31Z1251	MAINS ON/OFF SWITCH BEZEL	1	EA	1	3	6	
7	30Z1177	20 AMP LITTLEFUSE FLM020	2	EA	2	6	12	2
8	30Z1178	30A FUSE HOLDER	2	EA	2	6	12	
11	30Z1482	e2 MAINS FILTER 20VT-1	1	EA	1	3	6	
12	30Z1455	TRANSFORMER LV CLASS 2	1	EA	1	3	6	1
13	30Z1431	1.2uF 2500V CAPACITOR	1	EA	1	3	6	1
14	30Z1440	RELAY 240V OMRON	1	EA	1	3	6	1
17	30Z1475	CABINET FAN e2 LRG	2	EA	2	6	12	
17	30Z1542	e2 FAN MOTOR AC 4300 H	1	EA	1	3	6	
19	SJ358	e2 CAVITY THERMOCOUPLE	1	EA	1	3	6	1
22	30Z5014	CONTROL PCB e2 SRB VDE	1	EA	1	3	6	1
27	31Z0651	3-WAY TERMINAL BLOCK	2	EA	2	6	12	
29	31Z1308	CABLE GLAND PG16	1	EA	1	3	6	
30	31Z1309	GLAND NUT PG16	1	EA	1	3	6	
32	SJ371	ROBUST AIR FILTER EU	1	EA	1	3	6	1
43	SJ325	e2 LID ASSY EU	1	EA	1	3	6	
64	DJ0136	e2 16A EU MAINS LEAD ASSY	1	EA	1	3	6	
65	P30Z1413	230V 50Hz TRANSFORMER	1	EA	1	3	6	
75	SJ320	e2 BACK PANEL ASSY EU	1	EA	1	3	6	
79	SJ314	SIDE COVER RHS ASSY e2	1	EA	1	3	6	
80	SJ315	SIDE COVER LHS ASSY e2	1	EA	1	3	6	
86	30Z1439	RELAY 12V OMRON	1	EA	1	3	6	1
Not Numbered	DJ0185	MAG FAN SHROUD MK2	1	EA	1	3	6	

eikon e2 230Volts 50Hz 16A Parent - EU - Unique Parts

3	30Z0217	FUSE 1in 10A HRC	1	EA	1	3	6	1
4	30Z0231	FUSEHOLDER 1in (13A)	2	EA	2	6	12	
5	30Z0394	FUSE 1in 7A HRC	1	EA	1	3	6	1
6	31Z1250	MAINS ON/OFF SWITCH COVER	1	EA	1	3	6	
6	31Z1251	MAINS ON/OFF SWITCH BEZEL	1	EA	1	3	6	
7	30Z1177	20 AMP LITTLEFUSE FLM020	4	EA	4	12	24	2
8	30Z1178	30A FUSE HOLDER	4	EA	4	12	24	
11	30Z1482	e2 MAINS FILTER 20VT-1	1	EA	1	3	6	
12	30Z1455	TRANSFORMER LV CLASS 2	1	EA	1	3	6	1
13	30Z1431	1.2uF 2500V CAPACITOR	1	EA	1	3	6	1
14	30Z1440	RELAY 240V OMRON	1	EA	1	3	6	1
17	30Z1475	CABINET FAN e2 LRG	2	EA	2	6	12	
17	30Z1542	e2 FAN MOTOR AC 4300 H	1	EA	1	3	6	
19	SJ358	e2 CAVITY THERMOCOUPLE	1	EA	1	3	6	1
22	30Z5014	CONTROL PCB e2 SRB VDE	1	EA	1	3	6	1
27	31Z0651	3-WAY TERMINAL BLOCK	2	EA	2	6	12	
29	31Z1255	CABLE GLAND PG21	1	EA	1	3	6	
30	31Z1256	GLAND NUT PG21	1	EA	1	3	6	
32	SJ371	ROBUST AIR FILTER EU	1	EA	1	3	6	1
43	SJ325	e2 LID ASSY EU	1	EA	1	3	6	
64	DJ0137	e2 32A EU MAINS LEAD ASSY	1	EA	1	3	6	
65	P30Z1413	230V 50Hz TRANSFORMER	1	EA	1	3	6	
75	SJ328	e2P BACK PANEL ASSY	1	EA	1	3	6	
79	SJ314	SIDE COVER RHS ASSY e2	1	EA	1	3	6	
80	SJ315	SIDE COVER LHS ASSY e2	1	EA	1	3	6	
86	30Z1439	RELAY 12V OMRON	1	EA	1	3	6	1
Not Shown	31Z0655	e2 EU PARENT SOCKET 16A	1	EA	1	3	6	
Not Shown	33Z0068	e2 PARENT EARTH WIRE	1	EA	1	3	6	
Not Shown	33Z0069	e2 PARENT FUSE TO FUSE	1	EA	1	3	6	
Not Shown	33Z0070	e2 PARENT FUSE TO SOCKET	1	EA	1	3	6	
Not Numbered	DJ0185	MAG FAN SHROUD MK2	1	EA	1	3	6	

Merrychef eikon e2 Oven

Recommended Parts List

Recommended Min Stock Holding & Service List

Service Manual Exploded View	Part Number	Description	Qty Per Oven	Unit	1-10 Ovens	11-50 Ovens	51-100 Ovens	Recommended Service List
eikon e2 230Volts 50Hz 20A - EU - Unique Parts								
3	30Z0217	FUSE 1in 10A HRC	1	EA	1	3	6	1
4	30Z0231	FUSEHOLDER 1in (13A)	2	EA	2	6	12	
5	30Z0394	FUSE 1in 7A HRC	1	EA	1	3	6	1
6	31Z1250	MAINS ON/OFF SWITCH COVER	1	EA	1	3	6	
6	31Z1251	MAINS ON/OFF SWITCH BEZEL	1	EA	1	3	6	
7	30Z1177	20 AMP LITTLEFUSE FLM020	2	EA	2	6	12	2
8	30Z1178	30A FUSE HOLDER	2	EA	2	6	12	
11	30Z1482	e2 MAINS FILTER 20VT-1	1	EA	1	3	6	
12	30Z1455	TRANSFORMER LV CLASS 2	1	EA	1	3	6	1
13	30Z1431	1.2uF 2500V CAPACITOR	1	EA	1	3	6	1
17	30Z1475	CABINET FAN e2 LRG	2	EA	2	6	12	
17	30Z1542	e2 FAN MOTOR AC 4300 H	1	EA	1	3	6	
19	SJ358	e2 CAVITY THERMOCOUPLE	1	EA	1	3	6	1
22	30Z5014	CONTROL PCB e2 SRB VDE	1	EA	1	3	6	1
27	31Z0651	3-WAY TERMINAL BLOCK	2	EA	2	6	12	
29	31Z1255	CABLE GLAND BLACK PG21	1	EA	1	3	6	
30	31Z1256	NUT FOR CABLE GLAND PG21	1	EA	1	3	6	
32	SJ371	ROBUST AIR FILTER EU	1	EA	1	3	6	1
43	SJ325	e2 LID ASSY EU	1	EA	1	3	6	
64	DX0106	MAINS SUPPLY LEAD G (UL)	1	EA	1	3	6	
65	P30Z1413	230V 50Hz TRANSFORMER	1	EA	1	3	6	
75	SJ320	e2 BACK PANEL ASSY EU	1	EA	1	3	6	
79	SJ314	SIDE COVER RHS ASSY e2	1	EA	1	3	6	
80	SJ315	SIDE COVER LHS ASSY e2	1	EA	1	3	6	
Not Numbered	DJ0185	MAG FAN SHROUD MK2	1	EA	1	3	6	

eikon e2 208/240Volts 60Hz 15A - USA - Unique Parts

86	30Z1439	RELAY 12V OMRON	1	EA	1	3	6	1
3	30Z1508	e2 FUSE 10A 1 1/4in	1	EA	1	3	6	1
4	30Z0285	FUSE HOLDER 1 1/4in	1	EA	1	3	6	
8	30Z1505	e2 USA LARGE FUSE HOLDER	2	EA	2	6	12	
11	30Z1479	e2 RFI FILTER	1	EA	1	3	6	
12	30Z1455	TRANSFORMER LV CLASS 2	1	EA	1	3	6	1
13	30Z1501	0.91 uF HV CAP 2300V	1	EA	1	3	6	1
14	30Z1440	RELAY 240V OMRON	1	EA	1	3	6	1
17	30Z1475	CABINET FAN e2 LRG	2	EA	2	6	12	
17	30Z1476	CABINET FAN e2 SML	1	EA	1	3	6	
19	SJ358	e2 CAVITY THERMOCOUPLE	1	EA	1	3	6	1
22	30Z5010	CONTROL PCB e2 SRB	1	EA	1	3	6	1
28	31Z0661	e2 USA 2-WAY TERM BLOCK	1	EA	1	3	6	
29 & 30	31Z1331	e2 US GLAND + NUT	1	EA	1	3	6	
32	DJ0144	USA CARTRIDGE FILTER	1	EA	1	3	6	1
43	DJ0122	LID FINISHED e2 US	1	EA	1	3	6	
64	DJ0139	e2D MAINS LEAD SP 15A	1	EA	1	3	6	
66	P30Z1509	e2 TRANS 208-230V 60Hz	1	EA	1	3	6	
75	DJ0123	BACK COVER FINISHED US	1	EA	1	3	6	
79	SJ326	e2 SIDE COVER RH ASSY US	1	EA	1	3	6	
80	SJ327	e2 SIDE COVER LH ASSY US	1	EA	1	3	6	
Not Shown	30Z1474	e2 THERMAL TRIP	1	EA	1	3	6	1
Not Shown	30Z1526	e2 USA 15A FUSE	2	EA	2	6	12	1
Not Shown	31Z0527	SILASTIC RED		TUBE	0	0	0	
Not Shown	31Z1322	FAN GUARD LRG	1	EA	1	3	6	
Not Shown	31Z1323	FAN GUARD SML	1	EA	1	3	6	
Not Shown	31Z1324	e2 LEG 4 INCH	4	EA	4	12	24	
Not Numbered	DJ0141	REAR DUCT USA e2	1	EA	1	3	6	

Merrychef eikon e2 Oven

Recommended Parts List

Recommended Min Stock Holding & Service List

Service Manual Exploded View	Part Number	Description	Qty Per Oven	Unit	1-10 Ovens	11-50 Ovens	51-100 Ovens	Recommended Service List
eikon e2 208/240Volts 60Hz 15A Parent - USA - Unique Parts								
86	30Z1439	RELAY 12V OMRON	1	EA	1	3	6	1
3	30Z1508	e2 FUSE 10A 1 1/4in	1	EA	1	3	6	1
4	30Z0285	FUSE HOLDER 1 1/4in	1	EA	1	3	6	
8	30Z1505	e2 USA LARGE FUSE HOLDER	4	EA	4	12	24	
11	30Z1479	e2 RFI FILTER	1	EA	1	3	6	
12	30Z1455	TRANSFORMER LV CLASS 2	1	EA	1	3	6	1
13	30Z1501	0.91 uF HV CAP 2300V	1	EA	1	3	6	1
14	30Z1440	RELAY 240V OMRON	1	EA	1	3	6	1
17	30Z1475	CABINET FAN e2 LRG	2	EA	2	6	12	
17	30Z1476	CABINET FAN e2 SML	1	EA	1	3	6	
19	SJ358	e2 CAVITY THERMOCOUPLE	1	EA	1	3	6	1
22	30Z5010	CONTROL PCB e2 SRB	1	EA	1	3	6	1
28	31Z0661	e2 USA 2-WAY TERM BLOCK	1	EA	1	3	6	
29 & 30	31Z1331	e2 US GLAND + NUT	1	EA	1	3	6	
32	DJ0144	USA CARTRIDGE FILTER	1	EA	1	3	6	1
43	DJ0122	LID FINISHED e2 US	1	EA	1	3	6	
64	DJ0140	e2P MAINS LEAD DF 30A	1	EA	1	3	6	
66	P30Z1509	e2 TRANS 208-230V 60Hz	1	EA	1	3	6	
75	DJ0123	BACK COVER FINISHED US	1	EA	1	3	6	
79	SJ326	e2 SIDE COVER RH ASSY US	1	EA	1	3	6	
80	SJ327	e2 SIDE COVER LH ASSY US	1	EA	1	3	6	
Not Shown	30Z1474	e2 THERMAL TRIP	1	EA	1	3	6	1
Not Shown	30Z1494	e2 US DEPENDENDANT SOCKET	1	EA	1	3	6	
Not Shown	30Z1526	e2 USA 15A FUSE	4	EA	4	12	24	1
Not Shown	31Z0527	SILASTIC RED		TUBE	0	0	0	
Not Shown	31Z0659	e2 USA TWIN WIRE LOOM	1	EA	1	3	6	
Not Shown	31Z1322	FAN GUARD LRG	1	EA	1	3	6	
Not Shown	31Z1323	FAN GUARD SML	1	EA	1	3	6	
Not Shown	31Z1324	e2 LEG 4 INCH	4	EA	4	12	24	
Not Numbered	DJ0141	REAR DUCT USA e2	1	EA	1	3	6	

eikon e2 208/240Volts 60Hz 20A - USA - Unique Parts

86	30Z1439	RELAY 12V OMRON	1	EA	1	3	6	1
3	30Z1508	e2 FUSE 10A 1 1/4in	1	EA	1	3	6	1
4	30Z0285	FUSE HOLDER 1 1/4in	1	EA	1	3	6	
7	30Z1504	e2 USA FUSE HOLDER	1	EA	1	3	6	
11	30Z1479	e2 RFI FILTER	1	EA	1	3	6	
12	30Z1455	TRANSFORMER LV CLASS 2	1	EA	1	3	6	1
13	30Z1501	0.91 uF HV CAP 2300V	1	EA	1	3	6	1
17	30Z1475	CABINET FAN e2 LRG	2	EA	2	6	12	
17	30Z1476	CABINET FAN e2 SML	1	EA	1	3	6	
19	SJ358	e2 CAVITY THERMOCOUPLE	1	EA	1	3	6	1
22	30Z5010	CONTROL PCB e2 SRB	1	EA	1	3	6	1
28	31Z0661	e2 USA 2-WAY TERM BLOCK	1	EA	1	3	6	
29 & 30	31Z1331	e2 US GLAND + NUT	1	EA	1	3	6	
32	DJ0144	USA CARTRIDGE FILTER	1	EA	1	3	6	1
43	DJ0122	LID FINISHED e2 US	1	EA	1	3	6	
64	DJ0138	e2 USA 20A MAINS LEAD	1	EA	1	3	6	
66	P30Z1509	e2 TRANS 208-230V 60Hz	1	EA	1	3	6	
75	DJ0123	BACK COVER FINISHED US	1	EA	1	3	6	
79	SJ326	e2 SIDE COVER RH ASSY US	1	EA	1	3	6	
80	SJ327	e2 SIDE COVER LH ASSY US	1	EA	1	3	6	
Not Shown	30Z1474	e2 THERMAL TRIP	1	EA	1	3	6	1
Not Shown	30Z1527	e2 USA 20A FUSE	2	EA	2	6	12	1
Not Shown	31Z0527	SILASTIC RED		TUBE	0	0	0	
Not Shown	31Z1322	FAN GUARD LRG	1	EA	1	3	6	
Not Shown	31Z1323	FAN GUARD SML	1	EA	1	3	6	
Not Shown	31Z1324	e2 LEG 4 INCH	4	EA	4	12	24	
Not Numbered	DJ0141	REAR DUCT USA e2	1	EA	1	3	6	

Merrychef eikon e2 Oven

Recommended Parts List

Recommended Min Stock Holding & Service List

Service Manual Exploded View	Part Number	Description	Qty Per Oven	Unit	1-10 Ovens	11-50 Ovens	51-100 Ovens	Recommended Service List
------------------------------	-------------	-------------	--------------	------	------------	-------------	--------------	--------------------------

e2 Accessories

35	32Z4044	COOK PLATE 11 HOLE		EA				
Not Shown	32Z4045	e2 SOLID BREAD BASKET		EA				
Not Shown	32Z4046	e2 MESH BASE BASKET		EA				
Not Shown	32Z4051	1/4 GASRONORM DISH		EA				
Not Shown	32Z4053	e2 COOK/GRIDDLE TRAY		EA				
Not Shown	SR314	e2 PIZZA PADDLE		EA				

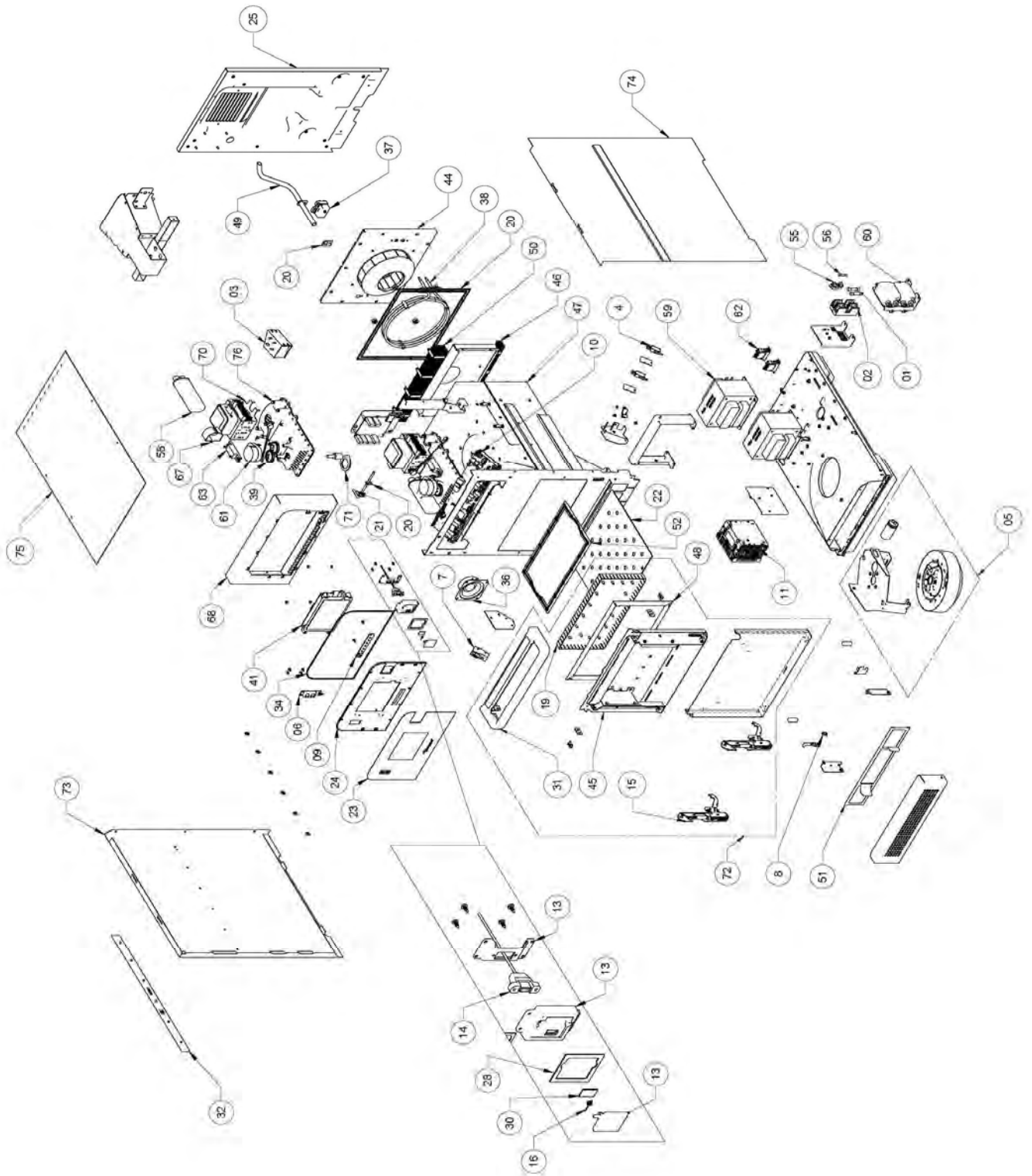

Merrychef eikon e2s Oven

Recommended Parts List

Recommended Min Stock Holding & Service List

Service Manual Exploded View	Part Number	Description	Qty Per Oven	Unit	1-10 Ovens	11-50 Ovens	51-100 Ovens	Recommended Service List
1	30Z1177	20 AMP LITTLEFUZE FLM020	2	EA	2	6	12	2
2	30Z1178	30A FUSE HOLDER	2	EA	2	6	12	
3	30Z1455	TRANSFORMER LV CLASS 2	1	EA	1	3	6	1
4	30Z1477	e2 MICROSWITCH SHORT ARM	2	EA	2	6	12	2
5	PSB203	e2s COOLING FAN ASSY	1	EA	1	3	6	
6	30Z1554	CONVOTHERM TOGGLE SWITCH	1	EA	1	3	6	1
7	30Z1566	SHORT LEVER MICROSWITCH	1	EA	1	3	6	1
8	30Z1562	AIR FILTER MICROSWITCH	1	EA	1	3	6	1
9	30Z5019	ILLUMINATION BOARD	1	EA	1	3	6	
10	30Z5021	CONTROL PCB UNI SRB	1	EA	1	3	6	1
11	30Z5022	e2s MOTOR SPEED CONTROLLER	1	EA	1	3	6	
13	SB374	USB PLASTIC PARTS ASSY	1	EA	1	3	6	
14	31Z0600	USB ADAPTOR MODULE	1	EA	1	3	6	
15	31Z1374	DOOR HINGE ASSY	2	EA	2	6	12	2
16	31Z1385	USB SPRING e2s	1	EA	1	3	6	
19	DB0031	DOOR CHOKE PLATE	1	EA	1	3	6	
20	DB0226	STEAM PIPE GASKET	1	EA	1	3	6	
20	DB0362	e2s MOTOR GASKET	1	EA	1	3	6	
20	PSBxxx	e2s GASKET KIT		EA	0	0	0	
21	DB0063	THERMOCOUPLE ASSY ANGLED	1	EA	1	3	6	1
22	DB0088PTFE	UPPER IMPINGER PLATE	1	EA	1	3	6	1
23	DB0127	TOUCHSCREEN OVERLAY	1	EA	1	3	6	1
24	DB0167	CONTROL D	1	EA	1	3	6	
25	DB0179	REAR CASEWORK PRESSED	1	EA	1	3	6	
28	DB0277	USB SEAL e2s	1	EA	1	3	6	
30	DB0279	MOUNT SEAL e2s	1	EA	1	3	6	
31	PSB367	e2s DOOR HANDLE ASSY COMPLETE	1	EA	1	3	6	
32	DB0301	e2s SIDE TRIM PLASTIC	2	EA	2	6	12	
33	DB0308	THERMOCOUPLE GASKET	1	EA	1	3	6	
34	DB0322	CONTROL D GASKET	1	EA	1	3	6	
36	DR0021	HARMONISED SPEAKER	1	EA	1	3	6	
37	DR0079	eikon OVER TEMP STAT	1	EA	1	3	6	1
38	PDR0142	e2s HEATER ELEMENT Kit	1	EA	1	3	6	
39	DV0552	GEAR - STIRRER WHEEL	6	EA	6	18	36	
41	P30Z5009	TOUCH SCREEN PCB	1	EA	1	3	6	1
44	PSB238	e2s CONVECTION MOTOR HANNING	1	EA	1	3	6	
45	SB214	e2s DOOR FRAME ASSY	1	EA	1	3	6	
46	SB314	LOWER CATALYST ASSEMBLY	1	EA	1	3	6	
47	SB368	e2s CAVITY ASSEMBLY	1	EA	1	3	6	
48	PSB316	e2s DOOR SEAL ASSY	1	EA	1	3	6	1
49	PSB318	e2s STEAM PIPE ASSY	1	EA	1	3	6	
50	SB325	UPPER CATALYST ASSEMBLY	1	EA	1	3	6	
51	SB326	AIR FILTER FRAME ASSY	1	EA	1	3	6	1
52	SB363	e2s PARTITION PLATE	1	EA	1	3	6	
Not Shown	30Z1457	eikon SRB 1.25A FUSE	1	EA	1	3	6	1
Not Shown	31Z0186	SILASTIC BLACK (DOOR SEAL)		TUBE	0	0	0	1
Not Shown	31Z0599	BTS UI SRB CABLE (WHITE)	1	EA	1	3	6	
Not Shown	32Z7079	PERSONALITY MODULE e2s SRB	1	EA	1	3	6	1
Not Shown	32Z7080	PERSONALITY MODULE e2s QTS	1	EA	1	3	6	1
Not Shown	DB0391	AIR DIFFUSER	1	EA	1	3	6	
Not Shown	DV0830	e4s SPEAKER WIRE	1	EA	1	3	6	
Not Shown	PSB332	e2s CAVITY INSULATION KIT	1	EA	1	3	6	
Not Shown	PSB333	e2s DOOR INSULATION KIT	1	EA	1	3	6	
Not Shown	PSBxxx	e2s DOOR MICROSWITCH KIT		EA	0	0	0	

Recommended Parts List

Recommended Min Stock Holding & Service List

Service Manual Exploded View	Part Number	Description	Qty Per Oven	Unit	1-10 Ovens	11-50 Ovens	51-100 Ovens	Recommended Service List
------------------------------	-------------	-------------	--------------	------	------------	-------------	--------------	--------------------------

eikon e2s 200/230Volts 50Hz 13A - UK - Classic - Unique Parts

55	30Z0231	FUSEHOLDER 1in (13A)	1	EA	1	3	6	
56	30Z0456	FUSE 1In 13A HRC	1	EA	1	3	6	1
57	30Z1427	MAGNETRON OVERHEAT STAT	1	EA	1	3	6	1
58	30Z1431	1.2uF 2500V CAPACITOR	1	EA	1	3	6	1
59	P30Z1540	HT TRANSFORMER 200/230V 50Hz	1	EA	1	3	6	
60	30Z1573	e2s MAINS FILTER	2	EA	2	6	12	
62	30Z1563	e2s RELAY	1	EA	1	3	6	1
63	30Z5013	HT DIODE BOARD EIKON	1	EA	1	3	6	1
67	DB0365	LARGE RAD CAP CLIP	1	EA	1	3	6	
68	DB0369	CONTROL PANEL CLASSIC	1	EA	1	3	6	
70	P30Z1415	MAGNETRON 2M303H	1	EA	1	3	6	1
71	PSR270	e2s STIRRER ASSY	1	EA	1	3	6	
72	PSB124	e2s DOOR ASSY - CLASSIC (COMPLETE)	1	EA	1	3	6	
73	PSB234	e2s LH CASWORK - CLASSIC	1	EA	1	3	6	
74	PSB233	e2s RH CASWORK - CLASSIC	1	EA	1	3	6	
75	SB373	LID ASSEMBLY CLASSIC	1	EA	1	3	6	
76	SR317	e2s WAVEGUIDE ASSY	1	EA	1	3	6	
Not Shown	31Z1308	CABLE GLAND PG16	1	EA	1	3	6	
Not Shown	31Z1309	GLAND NUT PG16	1	EA	1	3	6	
Not Numbered	DB0371	AIR FILTER BODY V2 CLASSIC	1	EA	1	3	6	
Not Shown	SR241	MAINS SUPPLY LEAD e2s AA 13A	1	EA	1	3	6	

eikon e2s 200/230Volts 50Hz 13A - UK - Red Trend - Unique Parts

As per above eikon 200/230Volts 50Hz 13A - UK - Classic but with Red Casework

68	DB0379	CONTROL PANEL - RED	1	EA	1	3	6	
72	PSB103	e2s DOOR ASSY - RED (COMPLETE)	1	EA	1	3	6	
73	PSB216	LH CASWORK ASSY - RED	1	EA	1	3	6	
74	PSB217	RH CASWORK ASSY - RED	1	EA	1	3	6	
Not Shown	PSBxxx	e2s LID ASSY TREND	1	EA	1	3	6	
Not Numbered	SB383	AIR FILTER BODY - RED	1	EA	1	3	6	

eikon e2s 200/230Volts 50Hz 13A - UK - Black Trend - Unique Parts

As per above eikon 200/230Volts 50Hz 13A - UK - Classic but with Black Casework

68	SB380	CONTROL PANEL - BLACK	1	EA	1	3	6	
72	PSB382	e2s DOOR ASSY - BLACK	1	EA	1	3	6	
73	PSB286	e2s LH CASWORK - BLACK	1	EA	1	3	6	
74	PSB285	e2s RH CASWORK - BLACK	1	EA	1	3	6	
Not Shown	PSBxxx	e2s LID ASSY TREND	1	EA	1	3	6	
Not Numbered	SB384	AIR FILTER BODY - BLACK	1	EA	1	3	6	

Recommended Parts List

Recommended Min Stock Holding & Service List

Service Manual Exploded View	Part Number	Description	Qty Per Oven	Unit	1-10 Ovens	11-50 Ovens	51-100 Ovens	Recommended Service List
eikon e2s 200/230Volts 50Hz 16A - 1P - EU - Classic - Unique Parts								
	55	30Z0231	FUSEHOLDER 1in (13A)	1	EA	1	3	6
	56	30Z0456	FUSE 1In 13A HRC	1	EA	1	3	6
	57	30Z1427	MAGNETRON OVERHEAT STAT	1	EA	1	3	6
	58	30Z1431	1.2uF 2500V CAPACITOR	1	EA	1	3	6
	59	P30Z1540	HT TRANSFORMER 200/230V 50Hz	1	EA	1	3	6
	60	30Z1573	e2s MAINS FILTER	2	EA	2	6	12
	61	PSR240	e2s STIRRER MOTOR ASSY	1	EA	1	3	6
	62	30Z1563	e2s RELAY	1	EA	1	3	6
	63	30Z5013	HT DIODE BOARD EIKON	1	EA	1	3	6
	67	DB0365	LARGE RAD CAP CLIP	1	EA	1	3	6
	68	DB0369	CONTROL PANEL CLASSIC	1	EA	1	3	6
	70	P30Z1415	MAGNETRON 2M303H	1	EA	1	3	6
	71	PSR270	e2s STIRRER ASSY	1	EA	1	3	6
	72	PSB124	e2s DOOR ASSY - CLASSIC (COMPLETE)	1	EA	1	3	6
	73	PSB234	e2s LH CASWORK - CLASSIC	1	EA	1	3	6
	74	PSB233	e2s RH CASWORK - CLASSIC	1	EA	1	3	6
	75	SB373	LID ASSEMBLY CLASSIC	1	EA	1	3	6
	76	SR317	e2s WAVEGUIDE ASSY	1	EA	1	3	6
Not Shown		31Z1255	CABLE GLAND BLACK PG21	1	EA	1	3	6
Not Shown		31Z1256	NUT FOR CABLE GLAND PG21	1	EA	1	3	6
Not Numbered		DB0371	AIR FILTER BODY V2 CLASSIC	1	EA	1	3	6
Not Shown		SR242	MAINS LEAD SUPPLY e2s AB 16A	1	EA	1	3	6

eikon e2s 200/230Volts 50Hz 16A - 1P - EU - Red Trend - Unique Parts

As per above eikon 200/230Volts 50Hz 16A - 1P - EU - Classic but with Red Casework

	68	DB0379	CONTROL PANEL - RED	1	EA	1	3	6
	72	PSB103	e2s DOOR ASSY - RED (COMPLETE)	1	EA	1	3	6
	73	PSB216	LH CASWORK ASSY - RED	1	EA	1	3	6
	74	PSB217	RH CASWORK ASSY - RED	1	EA	1	3	6
Not Shown		PSBxxx	e2s LID ASSY TREND	1	EA	1	3	6
Not Numbered		SB383	AIR FILTER BODY - RED	1	EA	1	3	6

eikon e2s 200/230Volts 50Hz 16A - 1P - EU - Black Trend - Unique Parts

As per above eikon 200/230Volts 50Hz 16A - 1P - EU - Classic but with Black Casework

	68	SB380	CONTROL PANEL - BLACK	1	EA	1	3	6
	72	PSB382	e2s DOOR ASSY - BLACK	1	EA	1	3	6
	73	PSB286	e2s LH CASWORK - BLACK	1	EA	1	3	6
	74	PSB285	e2s RH CASWORK - BLACK	1	EA	1	3	6
Not Shown		PSBxxx	e2s LID ASSY TREND	1	EA	1	3	6
Not Numbered		SB384	AIR FILTER BODY - BLACK	1	EA	1	3	6

Recommended Parts List

Recommended Min Stock Holding & Service List

Service Manual Exploded View	Part Number	Description	Qty Per Oven	Unit	1-10 Ovens	11-50 Ovens	51-100 Ovens	Recommended Service List
------------------------------	-------------	-------------	--------------	------	------------	-------------	--------------	--------------------------

eikon e2s 200/230Volts 50Hz 16A - 2P - EU - Classic - Unique Parts

55	30Z0231	FUSEHOLDER 1in (13A)	1	EA	1	3	6	
56	30Z0456	FUSE 1In 13A HRC	1	EA	1	3	6	1
57	30Z1427	MAGNETRON OVERHEAT STAT	2	EA	2	6	12	1
58	30Z1431	1.2uF 2500V CAPACITOR	2	EA	2	6	12	1
59	P30Z1540	HT TRANSFORMER 200/230V 50Hz	2	EA	2	6	12	
60	30Z1573	e2s MAINS FILTER	2	EA	2	6	12	
61	PSR240	e2s STIRRER MOTOR ASSY	2	EA	2	6	12	
62	30Z1563	e2s RELAY	2	EA	2	6	12	1
63	30Z5013	HT DIODE BOARD EIKON	1	EA	1	3	6	1
67	DB0365	LARGE RAD CAP CLIP	2	EA	2	6	12	
68	DB0369	CONTROL PANEL CLASSIC	1	EA	1	3	6	
70	P30Z1415	MAGNETRON 2M303H	2	EA	2	6	12	1
71	PSR270	e2s STIRRER ASSY	2	EA	2	6	12	
72	PSB124	e2s DOOR ASSY - CLASSIC (COMPLETE)	1	EA	1	3	6	
73	PSB234	e2s LH CASWORK - CLASSIC	1	EA	1	3	6	
74	PSB233	e2s RH CASWORK - CLASSIC	1	EA	1	3	6	
75	SB373	LID ASSEMBLY CLASSIC	1	EA	1	3	6	
76	SR317	e2s WAVEGUIDE ASSY	2	EA	2	6	12	
Not Shown	31Z1255	CABLE GLAND BLACK PG21	1	EA	1	3	6	
Not Shown	31Z1256	NUT FOR CABLE GLAND PG21	1	EA	1	3	6	
Not Numbered	DB0371	AIR FILTER BODY V2 CLASSIC	1	EA	1	3	6	
Not Shown	SR258	MAINS LEAD SUPPLY e2s BD 16A 2P	1	EA	1	3	6	

eikon e2s 200/230Volts 50Hz 16A - 2P - EU - Red Trend - Unique Parts

As per above eikon 200/230Volts 50Hz 16A - 2P - EU - Classic but with Red Casework

68	DB0379	CONTROL PANEL - RED	1	EA	1	3	6	
72	PSB103	e2s DOOR ASSY - RED (COMPLETE)	1	EA	1	3	6	
73	PSB216	LH CASWORK ASSY - RED	1	EA	1	3	6	
74	PSB217	RH CASWORK ASSY - RED	1	EA	1	3	6	
Not Shown	PSBxxx	e2s LID ASSY TREND	1	EA	1	3	6	
Not Numbered	SB383	AIR FILTER BODY - RED	1	EA	1	3	6	

eikon e2s 200/230Volts 50Hz 16A - 2P - EU - Black Trend - Unique Parts

As per above eikon 200/230Volts 50Hz 16A - 2P - EU - Classic but with Black Casework

68	SB380	CONTROL PANEL - BLACK	1	EA	1	3	6	
72	PSB382	e2s DOOR ASSY - BLACK	1	EA	1	3	6	
73	PSB286	e2s LH CASWORK - BLACK	1	EA	1	3	6	
74	PSB285	e2s RH CASWORK - BLACK	1	EA	1	3	6	
Not Shown	PSBxxx	e2s LID ASSY TREND	1	EA	1	3	6	
Not Numbered	SB384	AIR FILTER BODY - BLACK	1	EA	1	3	6	

Recommended Parts List

Recommended Min Stock Holding & Service List

Service Manual Exploded View	Part Number	Description	Qty Per Oven	Unit	1-10 Ovens	11-50 Ovens	51-100 Ovens	Recommended Service List
------------------------------	-------------	-------------	--------------	------	------------	-------------	--------------	--------------------------

eikon e2s 200/230Volts 50Hz 30A - 1P - EU - Classic - Unique Parts

55	30Z0231	FUSEHOLDER 1in (13A)	1	EA	1	3	6	
56	30Z0456	FUSE 1In 13A HRC	1	EA	1	3	6	1
57	30Z1427	MAGNETRON OVERHEAT STAT	2	EA	2	6	12	1
58	30Z1431	1.2uF 2500V CAPACITOR	2	EA	2	6	12	2
59	P30Z1540	HT TRANSFORMER 200/230V 50Hz	2	EA	2	6	12	
60	30Z1573	e2s MAINS FILTER	2	EA	2	6	12	
61	PSR240	e2s STIRRER MOTOR ASSY	2	EA	2	6	12	
62	30Z1563	e2s RELAY	2	EA	2	6	12	2
63	30Z5013	HT DIODE BOARD EIKON	2	EA	2	6	12	2
67	DB0365	LARGE RAD CAP CLIP	2	EA	2	6	12	
68	DB0369	CONTROL PANEL CLASSIC	1	EA	1	3	6	
70	P30Z1415	MAGNETRON 2M303H	2	EA	2	6	12	1
71	PSR270	e2s STIRRER ASSY	2	EA	2	6	12	
72	PSB124	e2s DOOR ASSY CLASSIC (COMPLETE)	1	EA	1	3	6	
73	PSB234	e2s LH CASWORK - CLASSIC	1	EA	1	3	6	
74	PSB233	e2s RH CASWORK - CLASSIC	1	EA	1	3	6	
75	SB373	LID ASSEMBLY CLASSIC	1	EA	1	3	6	
76	SR317	e2s WAVEGUIDE ASSY	2	EA	2	6	12	
Not Shown	31Z1255	CABLE GLAND BLACK PG21	1	EA	1	3	6	
Not Shown	31Z1256	NUT FOR CABLE GLAND PG21	1	EA	1	3	6	
Not Numbered	DB0371	AIR FILTER BODY V2 CLASSIC	1	EA	1	3	6	
Not Shown	SR250	MAINS LEAD SUPPLY e2s HE 30A Blue Plug	1	EA	1	3	6	

eikon e2s 200/230Volts 50Hz 30A - 1P - EU - Red Trend - Unique Parts

As per above eikon 200/230Volts 50Hz 30A - 1P - EU - Classic but with Red Casework

68	DB0379	CONTROL PANEL - RED	1	EA	1	3	6	
72	PSB103	e2s DOOR ASSY - RED (COMPLETE)	1	EA	1	3	6	
73	PSB216	LH CASWORK ASSY - RED	1	EA	1	3	6	
74	PSB217	RH CASWORK ASSY - RED	1	EA	1	3	6	
Not Shown	PSBxxx	e2s LID ASSY TREND	1	EA	1	3	6	
Not Numbered	SB383	AIR FILTER BODY - RED	1	EA	1	3	6	

eikon e2s 200/230Volts 50Hz 30A - 1P - EU - Black Trend - Unique Parts

As per above eikon 200/230Volts 50Hz 30A - 1P - EU - Classic but with Black Casework

68	SB380	CONTROL PANEL - BLACK	1	EA	1	3	6	
72	PSB382	e2s DOOR ASSY - BLACK	1	EA	1	3	6	
73	PSB286	e2s LH CASWORK - BLACK	1	EA	1	3	6	
74	PSB285	e2s RH CASWORK - BLACK	1	EA	1	3	6	
Not Shown	PSBxxx	e2s LID ASSY TREND	1	EA	1	3	6	
Not Numbered	SB384	AIR FILTER BODY - BLACK	1	EA	1	3	6	

Recommended Parts List

Recommended Min Stock Holding & Service List

Service Manual Exploded View	Part Number	Description	Qty Per Oven	Unit	1-10 Ovens	11-50 Ovens	51-100 Ovens	Recommended Service List
------------------------------	-------------	-------------	--------------	------	------------	-------------	--------------	--------------------------

eikon e2s 200/230Volts 50Hz 30A - AZ - Classic - Unique Parts

55	30Z0231	FUSEHOLDER 1in (13A)	1	EA	1	3	6	
56	30Z0456	FUSE 1In 13A HRC	1	EA	1	3	6	1
57	30Z1427	MAGNETRON OVERHEAT STAT	2	EA	2	6	12	1
58	30Z1431	1.2uF 2500V CAPACITOR	2	EA	2	6	12	2
59	P30Z1540	HT TRANSFORMER 200/230V 50Hz	2	EA	2	6	12	
60	30Z1573	e2s MAINS FILTER	2	EA	2	6	12	
61	PSR240	e2s STIRRER MOTOR ASSY	2	EA	2	6	12	
62	30Z1563	e2s RELAY	2	EA	2	6	12	2
63	30Z5013	HT DIODE BOARD EIKON	2	EA	2	6	12	2
67	DB0365	LARGE RAD CAP CLIP	2	EA	2	6	12	
68	DB0369	CONTROL PANEL CLASSIC	1	EA	1	3	6	
70	P30Z1415	MAGNETRON 2M303H	2	EA	2	6	12	1
71	PSR270	e2s STIRRER ASSY	2	EA	2	6	12	
72	PSBxxx	e2s DOOR ASSY TREND (COMPLETE)	1	EA	1	3	6	
73	PSB234	e2s LH CASWORK - CLASSIC	1	EA	1	3	6	
74	PSB233	e2s RH CASWORK - CLASSIC	1	EA	1	3	6	
75	SB373	LID ASSEMBLY CLASSIC	1	EA	1	3	6	
76	SR317	e2s WAVEGUIDE ASSY	2	EA	2	6	12	
Not Shown	31Z1255	CABLE GLAND BLACK PG21	1	EA	1	3	6	
Not Shown	31Z1256	NUT FOR CABLE GLAND PG21	1	EA	1	3	6	
Not Numbered	DB0371	AIR FILTER BODY V2 CLASSIC	1	EA	1	3	6	
Not Shown	SR249	MAINS LEAD SUPPLY e2s GK 30A	1	EA	1	3	6	

eikon e2s 200/230Volts 50Hz 30A - AZ - Black Trend - Unique Parts

As per above eikon 200/230Volts 50Hz 30A - AZ - Classic but with Black Casework

68	SB380	CONTROL PANEL - BLACK	1	EA	1	3	6	
72	PSB382	e2s DOOR ASSY - BLACK	1	EA	1	3	6	
73	PSB286	e2s LH CASWORK - BLACK	1	EA	1	3	6	
74	PSB285	e2s RH CASWORK - BLACK	1	EA	1	3	6	
Not Shown	PSBxxx	e2s LID ASSY TREND	1	EA	1	3	6	
Not Numbered	SB384	AIR FILTER BODY - BLACK	1	EA	1	3	6	

Recommended Parts List

Recommended Min Stock Holding & Service List

Service Manual Exploded View	Part Number	Description	Qty Per Oven	Unit	1-10 Ovens	11-50 Ovens	51-100 Ovens	Recommended Service List
------------------------------	-------------	-------------	--------------	------	------------	-------------	--------------	--------------------------

eikon e2s 208/240Volts 60Hz 15A - BR - Classic - Unique Parts

55	30Z1504	e2 USA FUSE HOLDER	1	EA	1	3	6	
56	30Z1507	12A FUSE SLOW/B	1	EA	1	3	6	1
57	30Z1427	MAGNETRON OVERHEAT STAT	1	EA	1	3	6	1
58	30Z1549	0.95 uF HV CAPACITOR 2500V	1	EA	1	3	6	1
59	P30Z1558	60Hz TRANS MULTI 208-240V	2	EA	2	6	12	
60	30Z1573	e2s MAINS FILTER	2	EA	2	6	12	
61	PSR240	e2s STIRRER MOTOR ASSY	1	EA	1	3	6	
63	30Z5013	HT DIODE BOARD EIKON	1	EA	1	3	6	1
67	DB0365	LARGE RAD CAP CLIP	1	EA	1	3	6	
68	DB0369	CONTROL PANEL CLASSIC	1	EA	1	3	6	
70	P30Z1415	MAGNETRON 2M303H	1	EA	1	3	6	1
71	PSR270	e2s STIRRER ASSY	1	EA	1	3	6	
72	PSB124	e2s DOOR ASSY CLASSIC (COMPLETE)	1	EA	1	3	6	
73	PSB234	e2s LH CASWORK - CLASSIC	1	EA	1	3	6	
74	PSB233	e2s RH CASWORK - CLASSIC	1	EA	1	3	6	
75	SB373	LID ASSEMBLY CLASSIC	1	EA	1	3	6	
76	SR317	e2s WAVEGUIDE ASSY	1	EA	1	3	6	
Not Shown	31Z1255	CABLE GLAND BLACK PG21	1	EA	1	3	6	
Not Shown	31Z1256	NUT FOR CABLE GLAND PG21	1	EA	1	3	6	
Not Numbered	DB0371	AIR FILTER BODY V2 CLASSIC	1	EA	1	3	6	
Not Shown	SR256	MAINS LEAD SUPPLY e2s SP 15A US	1	EA	1	3	6	

eikon e2s 208/240Volts 60Hz 30A - BR - Classic - Unique Parts

55	30Z1504	e2 USA FUSE HOLDER	1	EA	1	3	6	
56	30Z1507	12A FUSE SLOW/B	1	EA	1	3	6	1
57	30Z1427	MAGNETRON OVERHEAT STAT	2	EA	2	6	12	1
58	30Z1549	0.95 uF HV CAPACITOR 2500V	2	EA	2	6	12	2
59	P30Z1558	60Hz TRANS MULTI 208-240V	2	EA	2	6	12	
60	30Z1573	e2s MAINS FILTER	2	EA	2	6	12	
61	PSR240	e2s STIRRER MOTOR ASSY	2	EA	2	6	12	
62	30Z1563	e2s RELAY	2	EA	2	6	12	2
63	30Z5013	HT DIODE BOARD EIKON	2	EA	2	6	12	2
67	DB0365	LARGE RAD CAP CLIP	2	EA	2	6	12	
68	DB0369	CONTROL PANEL CLASSIC	1	EA	1	3	6	
70	P30Z1415	MAGNETRON 2M303H	2	EA	2	6	12	1
71	PSR270	e2s STIRRER ASSY	2	EA	2	6	12	
72	PSB124	e2s DOOR ASSY CLASSIC (COMPLETE)	1	EA	1	3	6	
73	PSB234	e2s LH CASWORK - CLASSIC	1	EA	1	3	6	
74	PSB233	e2s RH CASWORK - CLASSIC	1	EA	1	3	6	
75	SB373	LID ASSEMBLY CLASSIC	1	EA	1	3	6	
76	SR317	e2s WAVEGUIDE ASSY	2	EA	2	6	12	
Not Shown	31Z1255	CABLE GLAND BLACK PG21	1	EA	1	3	6	
Not Shown	31Z1256	NUT FOR CABLE GLAND PG21	1	EA	1	3	6	
Not Numbered	DB0371	AIR FILTER BODY V2 CLASSIC	1	EA	1	3	6	
Not Shown	SR246	MAINS LEAD SUPPLY e2s DJ 30A	1	EA	1	3	6	

Recommended Parts List

Recommended Min Stock Holding & Service List

Service Manual Exploded View	Part Number	Description	Qty Per Oven	Unit	1-10 Ovens	11-50 Ovens	51-100 Ovens	Recommended Service List
eikon e2s 200/230Volts 50Hz 15A - CN - Red Trend - Unique Parts								
55	30Z0231	FUSEHOLDER 1in (13A)	1	EA	1	3	6	
56	30Z0456	FUSE 1In 13A HRC	1	EA	1	3	6	1
57	30Z1427	MAGNETRON OVERHEAT STAT	1	EA	1	3	6	1
58	30Z1431	1.2uF 2500V CAPACITOR	1	EA	1	3	6	2
59	P30Z1540	HT TRANSFORMER 200/230V 50Hz	1	EA	1	3	6	
60	30Z1573	e2s MAINS FILTER	2	EA	2	6	12	
61	PSR240	e2s STIRRER MOTOR ASSY	1	EA	1	3	6	
62	30Z1563	e2s RELAY	1	EA	1	3	6	2
63	30Z5013	HT DIODE BOARD EIKON	1	EA	1	3	6	2
67	DB0365	LARGE RAD CAP CLIP	1	EA	1	3	6	
68	DB0379	CONTROL PANEL - RED	1	EA	1	3	6	
70	P30Z1415	MAGNETRON 2M303H	1	EA	1	3	6	1
71	PSR270	e2s STIRRER ASSY	1	EA	1	3	6	
72	PSB103	e2s DOOR ASSY - RED	1	EA	1	3	6	
73	PSB216	e2s LH CASWORK - RED	1	EA	1	3	6	
74	PSB217	e2s RH CASWORK - RED	1	EA	1	3	6	
76	SR317	e2s WAVEGUIDE ASSY	1	EA	1	3	6	
Not Shown	31Z1308	CABLE GLAND PG16	1	EA	1	3	6	
Not Shown	31Z1309	GLAND NUT PG16	1	EA	1	3	6	
Not Shown	PSBxxx	e2s LID ASSY TREND	1	EA	1	3	6	
Not Shown	SR259	MAINS LEAD ASSY e2s AV	1	EA	1	3	6	
Not Numbered	SB383	AIR FILTER BODY - RED	1	EA	1	3	6	

eikon e2s 200/230Volts 50Hz 15A - CN - Black Trend - Unique Parts

As per above eikon 200/230Volts 50Hz 15A - CN - Red Trend but with Black Casework

68	SB380	CONTROL PANEL - BLACK	1	EA	1	3	6	
72	PSB382	e2s DOOR ASSY - BLACK	1	EA	1	3	6	
73	PSB286	e2s LH CASWORK - BLACK	1	EA	1	3	6	
74	PSB285	e2s RH CASWORK - BLACK	1	EA	1	3	6	
Not Shown	PSBxxx	e2s LID ASSY TREND	1	EA	1	3	6	
Not Numbered	SB384	AIR FILTER BODY - BLACK	1	EA	1	3	6	

eikon e2s 200/230Volts 50Hz 30A - CN - Classic - Unique Parts

55	30Z0231	FUSEHOLDER 1in (13A)	1	EA	1	3	6	
56	30Z0456	FUSE 1In 13A HRC	1	EA	1	3	6	1
57	30Z1427	MAGNETRON OVERHEAT STAT	2	EA	2	6	12	1
58	30Z1431	1.2uF 2500V CAPACITOR	2	EA	2	6	12	2
59	P30Z1540	HT TRANSFORMER 200/230V 50Hz	2	EA	2	6	12	
60	30Z1573	e2s MAINS FILTER	2	EA	2	6	12	
61	PSR240	e2s STIRRER MOTOR ASSY	2	EA	2	6	12	
62	30Z1563	e2s RELAY	2	EA	2	6	12	2
63	30Z5013	HT DIODE BOARD EIKON	2	EA	2	6	12	2
67	DB0365	LARGE RAD CAP CLIP	2	EA	2	6	12	
68	DB0369	CONTROL PANEL CLASSIC	1	EA	1	3	6	
70	P30Z1415	MAGNETRON 2M303H	2	EA	2	6	12	1
71	PSR270	e2s STIRRER ASSY	2	EA	2	6	12	
72	PSB124	e2s DOOR ASSY CLASSIC (COMPLETE)	1	EA	1	3	6	
73	PSB234	e2s LH CASWORK - CLASSIC	1	EA	1	3	6	
74	PSB233	e2s RH CASWORK - CLASSIC	1	EA	1	3	6	
75	SB373	LID ASSEMBLY CLASSIC	1	EA	1	3	6	
76	SR317	e2s WAVEGUIDE ASSY	2	EA	2	6	12	
Not Shown	31Z1255	CABLE GLAND BLACK PG21	1	EA	1	3	6	
Not Shown	31Z1256	NUT FOR CABLE GLAND PG21	1	EA	1	3	6	
Not Numbered	DB0371	AIR FILTER BODY V2 CLASSIC	1	EA	1	3	6	
Not Shown	SR251	MAINS LEAD ASSY e2s KE 30A CHINA	1	EA	1	3	6	

Recommended Parts List

Recommended Min Stock Holding & Service List

Service Manual Exploded View	Part Number	Description	Qty Per Oven	Unit	1-10 Ovens	11-50 Ovens	51-100 Ovens	Recommended Service List
eikon e2s 220Volts 60Hz 20A - MX - Red Trend - Unique Parts								
	30Z1504	e2 USA FUSE HOLDER	1	EA	1	3	6	
	30Z1507	12A FUSE SLOW/B	1	EA	1	3	6	1
	30Z1427	MAGNETRON OVERHEAT STAT	1	EA	1	3	6	1
	30Z1549	0.95 uF HV CAPACITOR 2500V	1	EA	1	3	6	1
	P30Z1558	60Hz TRANS MULTI 208-240V	1	EA	1	3	6	
	30Z1547	MAINS FILTER 20ES86 (NOTE-1 BELOW)	1	EA	1	3	6	
	PSR240	e2s STIRRER MOTOR ASSY	1	EA	1	3	6	
	30Z1563	e2s RELAY	1	EA	1	3	6	1
	30Z5013	HT DIODE BOARD EIKON	1	EA	1	3	6	1
	DB0365	LARGE RAD CAP CLIP	1	EA	1	3	6	
	DB0379	CONTROL PANEL - RED	1	EA	1	3	6	
	P30Z1415	MAGNETRON 2M303H	1	EA	1	3	6	1
	PSR270	e2s STIRRER ASSY	1	EA	1	3	6	
	PSB103	e2s DOOR ASSY - RED	1	EA	1	3	6	
	PSB216	e2s LH CASWORK - RED	1	EA	1	3	6	
	PSB217	e2s RH CASWORK - RED	1	EA	1	3	6	
	SR317	e2s WAVEGUIDE ASSY	1	EA	1	3	6	
Not Shown	31Z1255	CABLE GLAND BLACK PG21	1	EA	1	3	6	
Not Shown	31Z1256	NUT FOR CABLE GLAND PG21	1	EA	1	3	6	
Not Shown	PSBxxx	e2s LID ASSY TREND	1	EA	1	3	6	
Not Shown	SR255	MAINS LEAD SUPPLY e2s SN 20A US	1	EA	1	3	6	
Not Numbered	SB383	AIR FILTER BODY - RED	1	EA	1	3	6	

eikon e2s 220Volts 60Hz 30A - MX - Classic - Unique Parts

	30Z1504	e2 USA FUSE HOLDER	1	EA	1	3	6	
	30Z1507	12A FUSE SLOW/B	1	EA	1	3	6	1
	30Z1427	MAGNETRON OVERHEAT STAT	2	EA	2	6	12	1
	30Z1549	0.95 uF HV CAPACITOR 2500V	2	EA	2	6	12	2
	P30Z1558	60Hz TRANS MULTI 208-240V	2	EA	2	6	12	
	30Z1573	e2s MAINS FILTER	2	EA	2	6	12	
	PSR240	e2s STIRRER MOTOR ASSY	2	EA	2	6	12	
	30Z1563	e2s RELAY	2	EA	2	6	12	2
	30Z5013	HT DIODE BOARD EIKON	2	EA	2	6	12	2
	DB0365	LARGE RAD CAP CLIP	2	EA	2	6	12	
	DB0369	CONTROL PANEL CLASSIC	1	EA	1	3	6	
	P30Z1415	MAGNETRON 2M303H	2	EA	2	6	12	1
	PSR270	e2s STIRRER ASSY	2	EA	2	6	12	
	PSB124	e2s DOOR ASSY CLASSIC (COMPLETE)	1	EA	1	3	6	
	PSB234	e2s LH CASWORK - CLASSIC	1	EA	1	3	6	
	PSB233	e2s RH CASWORK - CLASSIC	1	EA	1	3	6	
	SB373	LID ASSEMBLY CLASSIC	1	EA	1	3	6	
	SR317	e2s WAVEGUIDE ASSY	2	EA	2	6	12	
Not Shown	31Z1255	CABLE GLAND BLACK PG21	1	EA	1	3	6	
Not Shown	31Z1256	NUT FOR CABLE GLAND PG21	1	EA	1	3	6	
Not Numbered	DB0371	AIR FILTER BODY V2 CLASSIC	1	EA	1	3	6	
Not Shown	SR245	MAINS SUPPLY LEAD e2s DH	1	EA	1	3	6	

Recommended Parts List

Recommended Min Stock Holding & Service List

Service Manual Exploded View	Part Number	Description	Qty Per Oven	Unit	1-10 Ovens	11-50 Ovens	51-100 Ovens	Recommended Service List
------------------------------	-------------	-------------	--------------	------	------------	-------------	--------------	--------------------------

eikon e2s 208/240Volts 60Hz 15A - USA - Classic - Unique Parts

55	30Z1504	e2 USA FUSE HOLDER	1	EA	1	3	6	
56	30Z1507	12A FUSE SLOW/B	1	EA	1	3	6	1
57	30Z1427	MAGNETRON OVERHEAT STAT	1	EA	1	3	6	1
58	30Z1549	0.95 uF HV CAPACITOR 2500V	1	EA	1	3	6	1
59	P30Z1558	60Hz TRANS MULTI 208-240V	1	EA	1	3	6	
60	30Z1547	MAINS FILTER 20ES86 (NOTE-1 BELOW)	1	EA	1	3	6	
61	PSR240	e2s STIRRER MOTOR ASSY	1	EA	1	3	6	
62	30Z1563	e2s RELAY	1	EA	1	3	6	1
63	30Z5013	HT DIODE BOARD EIKON	1	EA	1	3	6	1
67	DB0365	LARGE RAD CAP CLIP	1	EA	1	3	6	
68	DB0369	CONTROL PANEL CLASSIC	1	EA	1	3	6	
70	P30Z1415	MAGNETRON 2M303H	1	EA	1	3	6	1
71	PSR270	e2s STIRRER ASSY	1	EA	1	3	6	
72	PSB124	e2s DOOR ASSY CLASSIC (COMPLETE)	1	EA	1	3	6	
73	PSB234	e2s LH CASWORK - CLASSIC	1	EA	1	3	6	
74	PSB233	e2s RH CASWORK - CLASSIC	1	EA	1	3	6	
75	SB373	LID ASSEMBLY CLASSIC	1	EA	1	3	6	
76	SR317	e2s WAVEGUIDE ASSY	1	EA	1	3	6	
Not Shown	31Z1255	CABLE GLAND BLACK PG21	1	EA	1	3	6	
Not Shown	31Z1256	NUT FOR CABLE GLAND PG21	1	EA	1	3	6	
Not Numbered	DB0371	AIR FILTER BODY V2 CLASSIC	1	EA	1	3	6	
Not Shown	SR256	MAINS LEAD SUPPLY e2s SP 15A US	1	EA	1	3	6	

eikon e2s 208/240Volts 60Hz 15A - USA - Red Trend - Unique Parts

As per above eikon 208/240Volts 60Hz 15A - USA - Classic but with Red Casework

68	DB0379	CONTROL PANEL - RED	1	EA	1	3	6	
72	PSB103	e2s DOOR ASSY - RED (COMPLETE)	1	EA	1	3	6	
73	PSB216	LH CASWORK ASSY - RED	1	EA	1	3	6	
74	PSB217	RH CASWORK ASSY - RED	1	EA	1	3	6	
Not Shown	PSBxxx	e2s LID ASSY TREND	1	EA	1	3	6	
Not Numbered	SB383	AIR FILTER BODY - RED	1	EA	1	3	6	

eikon e2s 208/240Volts 60Hz 15A - USA - Black Trend - Unique Parts

As per above eikon 208/240Volts 60Hz 15A - USA - Classic but with Black Casework

68	SB380	CONTROL PANEL - BLACK	1	EA	1	3	6	
72	PSB382	e2s DOOR ASSY - BLACK	1	EA	1	3	6	
73	PSB286	e2s LH CASWORK - BLACK	1	EA	1	3	6	
74	PSB285	e2s RH CASWORK - BLACK	1	EA	1	3	6	
Not Shown	PSBxxx	e2s LID ASSY TREND	1	EA	1	3	6	
Not Numbered	SB384	AIR FILTER BODY - BLACK	1	EA	1	3	6	

Recommended Parts List

Recommended Min Stock Holding & Service List

Service Manual Exploded View	Part Number	Description	Qty Per Oven	Unit	1-10 Ovens	11-50 Ovens	51-100 Ovens	Recommended Service List
------------------------------	-------------	-------------	--------------	------	------------	-------------	--------------	--------------------------

eikon e2s 208/240Volts 60Hz 20A - USA - Classic - Unique Parts

55	30Z1504	e2 USA FUSE HOLDER	1	EA	1	3	6	
56	30Z1507	12A FUSE SLOW/B	1	EA	1	3	6	1
57	30Z1427	MAGNETRON OVERHEAT STAT	1	EA	1	3	6	1
58	30Z1549	0.95 uF HV CAPACITOR 2500V	1	EA	1	3	6	1
59	P30Z1558	60Hz TRANS MULTI 208-240V	1	EA	1	3	6	
60	30Z1547	MAINS FILTER 20ES86 (NOTE-1 BELOW)	1	EA	1	3	6	
61	PSR240	e2s STIRRER MOTOR ASSY	1	EA	1	3	6	
62	30Z1563	e2s RELAY	1	EA	1	3	6	1
63	30Z5013	HT DIODE BOARD EIKON	1	EA	1	3	6	1
67	DB0365	LARGE RAD CAP CLIP	1	EA	1	3	6	
68	DB0369	CONTROL PANEL CLASSIC	1	EA	1	3	6	
70	P30Z1415	MAGNETRON 2M303H	1	EA	1	3	6	1
71	PSR270	e2s STIRRER ASSY	1	EA	1	3	6	
72	PSB124	e2s DOOR ASSY CLASSIC (COMPLETE)	1	EA	1	3	6	
73	PSB234	e2s LH CASWORK - CLASSIC	1	EA	1	3	6	
74	PSB233	e2s RH CASWORK - CLASSIC	1	EA	1	3	6	
75	SB373	LID ASSEMBLY CLASSIC	1	EA	1	3	6	
76	SR317	e2s WAVEGUIDE ASSY	1	EA	1	3	6	
Not Shown	31Z1255	CABLE GLAND BLACK PG21	1	EA	1	3	6	
Not Shown	31Z1256	NUT FOR CABLE GLAND PG21	1	EA	1	3	6	
Not Numbered	DB0371	AIR FILTER BODY V2 CLASSIC	1	EA	1	3	6	
Not Shown	SR255	MAINS LEAD SUPPLY e2s SN 20A US	1	EA	1	3	6	

eikon e2s 208/240Volts 60Hz 20A - USA - Red Trend - Unique Parts

As per above eikon 208/240Volts 60Hz 20A - USA - Classic but with Red Casework

68	DB0379	CONTROL PANEL - RED	1	EA	1	3	6	
72	PSB103	e2s DOOR ASSY - RED (COMPLETE)	1	EA	1	3	6	
73	PSB216	LH CASWORK ASSY - RED	1	EA	1	3	6	
74	PSB217	RH CASWORK ASSY - RED	1	EA	1	3	6	
Not Shown	PSBxxx	e2s LID ASSY TREND	1	EA	1	3	6	
Not Numbered	SB383	AIR FILTER BODY - RED	1	EA	1	3	6	

eikon e2s 208/240Volts 60Hz 20A - USA - Black Trend - Unique Parts

As per above eikon 208/240Volts 60Hz 20A - USA - Classic but with Black Casework

68	SB380	CONTROL PANEL - BLACK	1	EA	1	3	6	
72	PSB382	e2s DOOR ASSY - BLACK	1	EA	1	3	6	
73	PSB286	e2s LH CASWORK - BLACK	1	EA	1	3	6	
74	PSB285	e2s RH CASWORK - BLACK	1	EA	1	3	6	
Not Shown	PSBxxx	e2s LID ASSY TREND	1	EA	1	3	6	
Not Numbered	SB384	AIR FILTER BODY - BLACK	1	EA	1	3	6	

Recommended Parts List

Recommended Min Stock Holding & Service List

Service Manual Exploded View	Part Number	Description	Qty Per Oven	Unit	1-10 Ovens	11-50 Ovens	51-100 Ovens	Recommended Service List
eikon e2s 208/240Volts 60Hz 30A - USA - Classic - Unique Parts								
	55	30Z1504	e2 USA FUSE HOLDER	1	EA	1	3	6
	56	30Z1507	12A FUSE SLOW/B	1	EA	1	3	6
	57	30Z1427	MAGNETRON OVERHEAT STAT	2	EA	2	6	12
	58	30Z1549	0.95 uF HV CAPACITOR 2500V	2	EA	2	6	12
	59	P30Z1558	60Hz TRANS MULTI 208-240V	2	EA	2	6	12
	60	30Z1573	e2s MAINS FILTER	2	EA	2	6	12
	61	PSR240	e2s STIRRER MOTOR ASSY	2	EA	2	6	12
	62	30Z1563	e2s RELAY	2	EA	2	6	12
	63	30Z5013	HT DIODE BOARD EIKON	2	EA	2	6	12
	67	DB0365	LARGE RAD CAP CLIP	2	EA	2	6	12
	68	DB0369	CONTROL PANEL CLASSIC	1	EA	1	3	6
	70	P30Z1415	MAGNETRON 2M303H	2	EA	2	6	12
	71	PSR270	e2s STIRRER ASSY	2	EA	2	6	12
	72	PSB124	e2s DOOR ASSY CLASSIC (COMPLETE)	1	EA	1	3	6
	73	PSB234	e2s LH CASWORK - CLASSIC	1	EA	1	3	6
	74	PSB233	e2s RH CASWORK - CLASSIC	1	EA	1	3	6
	75	SB373	LID ASSEMBLY CLASSIC	1	EA	1	3	6
	76	SR317	e2s WAVEGUIDE ASSY	2	EA	2	6	12
Not Shown		31Z1255	CABLE GLAND BLACK PG21	1	EA	1	3	6
Not Shown		31Z1256	NUT FOR CABLE GLAND PG21	1	EA	1	3	6
Not Numbered		DB0371	AIR FILTER BODY V2 CLASSIC	1	EA	1	3	6
Not Shown		SR245	MAINS SUPPLY LEAD e2s DH	1	EA	1	3	6

eikon e2s 208/240Volts 60Hz 30A - USA - Red Trend - Unique Parts

As per above eikon 208/240Volts 60Hz 30A - USA - Classic but with Red Casework

	68	DB0379	CONTROL PANEL - RED	1	EA	1	3	6
	72	PSB103	e2s DOOR ASSY - RED (COMPLETE)	1	EA	1	3	6
	73	PSB216	LH CASWORK ASSY - RED	1	EA	1	3	6
	74	PSB217	RH CASWORK ASSY - RED	1	EA	1	3	6
Not Shown		PSBxxx	e2s LID ASSY TREND	1	EA	1	3	6
Not Numbered		SB383	AIR FILTER BODY - RED	1	EA	1	3	6

eikon e2s 208/240Volts 60Hz 30A - USA - Black Trend - Unique Parts

As per above eikon 208/240Volts 60Hz 30A - USA - Classic but with Black Casework

	68	SB380	CONTROL PANEL - BLACK	1	EA	1	3	6
	72	PSB382	e2s DOOR ASSY - BLACK	1	EA	1	3	6
	73	PSB286	e2s LH CASWORK - BLACK	1	EA	1	3	6
	74	PSB285	e2s RH CASWORK - BLACK	1	EA	1	3	6
Not Shown		PSBxxx	e2s LID ASSY TREND	1	EA	1	3	6
Not Numbered		SB384	AIR FILTER BODY - BLACK	1	EA	1	3	6

e2s Accessories

Not Shown		32Z4068	e2s COOK PLATE	1	EA	1	3	6
Not Shown		32Z4079	GASTRONORM 1/4 65mm PAN	1	EA	1	3	6
Not Shown		32Z4080	e2s S/BASKET 11"x11"		EA	0	0	0
Not Shown		32Z4088	e2s LINER		EA	0	0	0
Not Shown		32Z4089	e2s S/BASKET QTR SIZE		EA	0	0	0
Not Shown		32Z4090	e2s S/BASKET HALF SIZE		EA	0	0	0
Not Shown		32Z4093	e2s S/BASKET 11"x11" GREEN		EA	0	0	0
Not Shown		32Z4094	e2s S/BASKET 1/2 SIZE GREEN		EA	0	0	0
Not Shown		32Z4095	e2s S/BASKET 1/4 SIZE GREEN		EA	0	0	0
Not Shown		32Z4096	e2s LINER GREEN		EA	0	0	0
Not Shown		DB0094	e2s COOK PLATE		EA	0	0	0
Not Shown		SB360	COMBINED LOWER JET PLATE		EA	0	0	0
Not Shown		SR318	GUARDED PADDLE e2s		EA	0	0	0
Not Shown		SR319	PIZZA PADDLE e2s		EA	0	0	0

NOTES: **NOTE-1** 30Z1573 will replace 30Z1547 once stock is depleted on all USA Models

Merrychef eikon e3 Oven - Exploded View

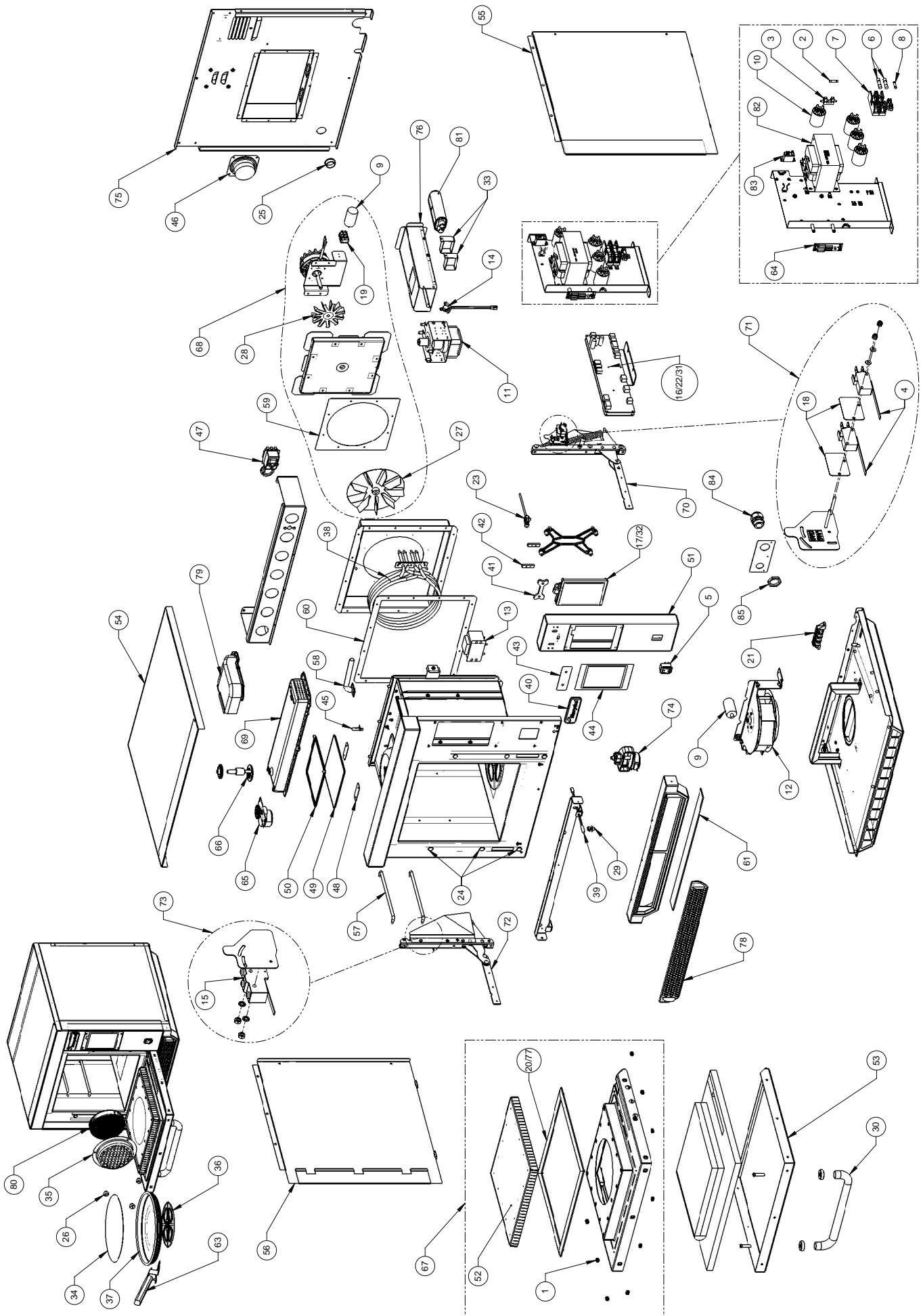

SPARES & REPLACEMENT

Merrychef eikon e3 Oven

Recommended Parts List

Recommended Min Stock Holding & Service List

Service Manual Exploded View	Part Number	Description	Qty Per Oven	Unit	1-10 Ovens	11-50 Ovens	51-100 Ovens	Recommended Service List
1	31Z4046	M3 CAGE NUT	9	EA	9	27	54	
4	30Z1459	MICROSWITCH	2	EA	2	6	12	2
5	30Z0503	SWITCH ON/OFF ROCKER DPST	1	EA	1	3	6	1
6	30Z1177	20 AMP LITTLEFUSE FLM020	2	EA	2	6	12	2
7	30Z1178	30A FUSE HOLDER	2	EA	2	6	12	
9 - 12	PSX286	e3 COOLING FAN KIT	1	EA	1	3	6	
10	30Z1340	FILTER 16A SCREW MOUNT	4	EA	4	12	24	
11	P30Z1415	MAGNETRON 2M303H	1	EA	1	3	6	1
13	30Z1425	LV TRANSFORMER	1	EA	1	3	6	1
14	30Z1427	MAGNETRON OVERHEAT STAT	1	EA	1	3	6	1
15	30Z1430	MICROSWITCH (LARGE)	1	EA	1	3	6	1
16	31Z0599	BTS UI SRB CABLE (WHITE)	1	EA	1	3	6	
16	P30Z5000	SMART RELAY BOARD SRB	1	EA	1	3	6	1
17	P30Z5009	TOUCH SCREEN PCB	1	EA	1	3	6	1
18	31Z0115	INSULATOR PAD	2	EA	2	6	12	
19	31Z0630	3-WAY TERMINAL BLOCK	1	EA	1	3	6	
20	31Z0186	SILASTIC BLACK (DOOR SEAL)		TUBE	0	0	0	1
21	31Z0477	4 WAY MAINS TERMINAL BLOCK	1	EA	1	3	6	
23	31Z0600	USB ADAPTOR MODULE	1	EA	1	3	6	
24	31Z1259	SHEET COVER CAP 12MM DIA	6	EA	6	18	36	
25	31Z1307	ETHERNET HOLE PLUG	1	EA	1	3	6	
26	DX0146	SCREW CAT COVER e3	3	EA	3	9	18	
26 - 35 - 80	PSX175	UPGRADE KIT e3N TO e3C		EA	0	0	0	
27	SR314	FAN BLADE ASSY e3 & e5	1	EA	1	3	6	
28	31Z4042	MOTOR COOLING FAN BLADE	1	EA	1	3	6	
29	31Z7086	REED SWITCH RETAIN CLIP	1	EA	1	3	6	
30	DV0431	DOOR HANDLE	1	EA	1	3	6	
30 - 53 - 67	PSX174	DOOR ASSY e3	1	EA	1	3	6	
31	32Z7061	PERSONALITY MODULE SRB e3	1	EA	1	3	6	1
32	32Z7064	PERSONALITY MODULE BTS e3	1	EA	1	3	6	1
33	40H0046	CAPACITOR CLIP - SINGLE	2	EA	2	6	12	
35	40H0221	EC403 CAT COVER (REMOVABLE)	1	EA	1	3	6	
38	PSX173	HEATER ASSEMBLY KIT e3	1	EA	1	3	6	
39	DR0006	REED SWITCH	1	EA	1	3	6	1
40	DR0007	MERRYCHEF BADGE	1	EA	1	3	6	
41	DR0008	MERRYCHEF BADGE SLIDER	1	EA	1	3	6	
42	DR0009	MERRYCHEF BADGE GUIDE	1	EA	1	3	6	
43	DR0047	MERRYCHEF BADGE SEAL	1	EA	1	3	6	
44	DR0011	TOUCHSCREEN OVERLAY	1	EA	1	3	6	1
45	DR0020	CAVITY TEMP SENSOR (OVEN)	1	EA	1	3	6	1
46	DR0021	HARMONISED SPEAKER	1	EA	1	3	6	
47	DR0042	OVERHEAT SAFETY STAT	1	EA	1	3	6	1
48	DV0202	CERAMIC PLATE RETAINER	2	EA	2	6	12	
49	DR0060	e3/e4s PARTITION PLATE	1	EA	1	3	6	1
50	DV0692	SEAL - CERAMIC COVER	1	EA	1	3	6	1
51	DX0195	CONTROL BOX FINISHED v2 (NOTE-1 BELOW)	1	EA	1	3	6	
52	DX0191	DOOR CHOKE FINISHED e3 v2	1	EA	1	3	6	
53	DX0198	DOOR SKIN FINISHED e3 v2	1	EA	1	3	6	
54	DX0199	TOP PANEL e3 v2 (NOTE-1 BELOW)	1	EA	1	3	6	
55	DX0180	RHS CASEWORK e3 v2 (NOTE-1 BELOW)	1	EA	1	3	6	
55	DX0219	RH CASEWORK e3 (NOTE-2 BELOW)	1	EA	1	3	6	
56	DX0179	LHS CASEWORK v2 (NOTE-1 BELOW)	1	EA	1	3	6	
56	DX0220	LH CASEWORK e3 (NOTE-2 BELOW)	1	EA	1	3	6	
57	DX0031	CAVITY SHELF RUNNER	4	EA	4	12	24	
58	SX320	STEAM PIPE	1	EA	1	3	6	
59	DX0058	HOT BOX 2 MOTOR SEAL	1	EA	1	3	6	
60	DX0059	CAVITY 2 HOT BOX SEAL	1	EA	1	3	6	
61	DX0083	FRONT TRIM SEAL	1	EA	1	3	6	
64	PSR109	DIODE REPLACEMENT KIT	1	EA	1	3	6	1
65	PSA288	STIRRER MOTOR ASSY (PINNED)	1	EA	1	3	6	
66	PSA291	STIRRER ASSY (PINNED)	1	EA	1	3	6	
67	PSX202	DOOR FRAME ASSY e3	1	EA	1	3	6	
68	PSX209	HOT AIR MOTOR SUB-ASSY (NOTE-5 BELOW)	1	EA	1	3	6	
68	PSX284	e3 CONVECTION MOTOR ASSY	1	EA	1	3	6	
69	SA374	CAST WAVEGUIDE ASSY	1	EA	1	3	6	
70 - 72	PSR101	EIKON DOOR HINGE KIT (NOTE-6 BELOW)	1	EA	1	3	6	
71 - 73	PSR102	EIKON M/SWITCH BRACKET KIT	1	EA	1	3	6	
74	PSX203	TURNTABLE DRIVE ASSY	1	EA	1	3	6	

Merrychef eikon e3 Oven

Recommended Parts List

Recommended Min Stock Holding & Service List

Service Manual Exploded View	Part Number	Description	Qty Per Oven	Unit	1-10 Ovens	11-50 Ovens	51-100 Ovens	Recommended Service List
75	SX333	REAR CASEWORK ASSY e3 v2 (NOTE-1 BELOW)	1	EA	1	3	6	
76	SX334	EXHAUST DUCT ASSY e3 v2	1	EA	1	3	6	
77	SX307	DOOR SEAL ASSY	1	EA	1	3	6	1
78	SX328	AIR FILTER ASSY (NOTE-2 BELOW)	1	EA	1	3	6	1
79	PSX278	WAVEGUIDE AIR DUCT	1	EA	1	3	6	
80	SX315	CERAMIC CAT CONVERTER	1	EA	1	3	6	
Not Shown	30Z1457	EIKON SRB 1.25A FUSE	1	EA	1	3	6	1
Not Shown	DR0045	SPEAKER WIRE	1	EA	1	3	6	
Not Numbered	DX0194	HOT BOX FINISHED e3 v2	1	EA	1	3	6	
Not Shown	DX0235	REED SWITCH BRACKET (NOTE-2 BELOW)	1	EA	1	3	6	
Not Numbered	SX338	CAVITY ASSY e3 (NOTE-3 BELOW)	1	EA	1	3	6	
Not Shown	SX339	AIR FILTER ASSY e3 (NOTE-3 BELOW)	1	EA	1	3	6	1

eikon e3 EE - 230Volts 50HZ - UK/EU - Unique Parts

2	30Z0217	FUSE 1in 10A HRC	1	EA	1	3	6	1
3	30Z0231	FUSEHOLDER 1in (13A)	2	EA	2	6	12	
8	30Z1207	FUSE 1in 3A HBC	1	EA	1	3	6	1
9	30Z1298	CAPACITOR - MOTOR START (NOTE-4 BELOW)	2	EA	2	6	12	
81	30Z1330	0.88uF 2500V CAPACITOR	1	EA	1	3	6	1
82	P30Z1413	230V 50Hz TRANSFORMER	1	EA	1	3	6	
83	30Z1440	RELAY 240V OMRON	1	EA	1	3	6	1
84	31Z1308	CABLE GLAND PG16	1	EA	1	3	6	
85	31Z1309	GLAND NUT PG16	1	EA	1	3	6	
Not Shown	DX0101	MAINS SUPPLY LEAD A (UK)	1	EA	1	3	6	
Not Shown	DX0103	MAINS SUPPLY LEAD C (EU)	1	EA	1	3	6	

eikon e3 XE - 230Volts 50HZ - UK/EU - Unique Parts

2	30Z0217	FUSE 1in 10A HRC	1	EA	1	3	6	1
3	30Z0231	FUSEHOLDER 1in (13A)	2	EA	2	6	12	
8	30Z1207	FUSE 1in 3A HBC	1	EA	1	3	6	1
9	30Z1298	CAPACITOR - MOTOR START (NOTE-4 BELOW)	2	EA	2	6	12	
81	30Z1330	0.88uF 2500V CAPACITOR	1	EA	1	3	6	1
82	P30Z1413	230V 50Hz TRANSFORMER	1	EA	1	3	6	
84	31Z1255	CABLE GLAND BLACK PG21	1	EA	1	3	6	
85	31Z1256	NUT FOR CABLE GLAND PG21	1	EA	1	3	6	
Not Shown	DX0102	MAINS SUPPLY LEAD BC 2P (UK)	1	EA	1	3	6	
Not Shown	DX0106	MAINS SUPPLY LEAD CE 1P (UK/EU)	1	EA	1	3	6	
Not Shown	DX0109	MAINS SUPPLY LEAD BD 2P (EU)	1	EA	1	3	6	

eikon e3 XX - 230Volts 50HZ - UK/EU - Unique Parts

2	30Z0217	FUSE 1in 10A HRC	1	EA	1	3	6	1
3	30Z0231	FUSEHOLDER 1in (13A)	2	EA	2	6	12	
8	30Z1207	FUSE 1in 3A HBC	1	EA	1	3	6	1
9	30Z1298	CAPACITOR - MOTOR START (NOTE-4 BELOW)	2	EA	2	6	12	
81	30Z1431	1.2uF 2500V CAPACITOR	1	EA	1	3	6	1
82	P30Z1413	230V 50Hz TRANSFORMER	1	EA	1	3	6	
84	31Z1255	CABLE GLAND BLACK PG21	1	EA	1	3	6	
85	31Z1256	NUT FOR CABLE GLAND PG21	1	EA	1	3	6	
Not Shown	DX0102	MAINS SUPPLY LEAD BC 2P (UK)	1	EA	1	3	6	
Not Shown	DX0106	MAINS SUPPLY LEAD CE 1P (UK/EU)	1	EA	1	3	6	
Not Shown	DX0109	MAINS SUPPLY LEAD BD 2P (EU)	1	EA	1	3	6	

Merrychef eikon e3 Oven

Recommended Parts List

Recommended Min Stock Holding & Service List

Service Manual Exploded View	Part Number	Description	Qty Per Oven	Unit	1-10 Ovens	11-50 Ovens	51-100 Ovens	Recommended Service List
------------------------------	-------------	-------------	--------------	------	------------	-------------	--------------	--------------------------

eikon e3 XX - 230Volts 50HZ - AZ - Unique Parts

2	30Z0217	FUSE 1in 10A HRC	1	EA	1	3	6	1
3	30Z0231	FUSEHOLDER 1in (13A)	2	EA	2	6	12	
8	30Z1207	FUSE 1in 3A HBC	1	EA	1	3	6	1
9	30Z1298	CAPACITOR - MOTOR START (NOTE-4 BELOW)	2	EA	2	6	12	
81	30Z1431	1.2uF 2500V CAPACITOR	1	EA	1	3	6	1
82	P30Z1413	230V 50Hz TRANSFORMER	1	EA	1	3	6	
84	31Z1255	CABLE GLAND BLACK PG21	1	EA	1	3	6	
85	31Z1256	NUT FOR CABLE GLAND PG21	1	EA	1	3	6	
Not Shown	DX0111	MAINS SUPPLY LEAD BZ 2P (AZ)	1	EA	1	3	6	

eikon e3 XX - 230Volts 50HZ - CN - Unique Parts

2	30Z0217	FUSE 1in 10A HRC	1	EA	1	3	6	1
3	30Z0231	FUSEHOLDER 1in (13A)	2	EA	2	6	12	
8	30Z1207	FUSE 1in 3A HBC	1	EA	1	3	6	1
9	30Z1298	CAPACITOR - MOTOR START (NOTE-4 BELOW)	2	EA	2	6	12	
81	30Z1431	1.2uF 2500V CAPACITOR	1	EA	1	3	6	1
82	P30Z1413	230V 50Hz TRANSFORMER	1	EA	1	3	6	
84	31Z1255	CABLE GLAND BLACK PG21	1	EA	1	3	6	
85	31Z1256	NUT FOR CABLE GLAND PG21	1	EA	1	3	6	
Not Shown	DX0110	MAINS SUPPLY LEAD JE 1P (CN)	1	EA	1	3	6	

eikon e3 XX - 220Volts 60HZ - BR - Unique Parts

3	30Z0285	FUSEHOLDER 1 1/4in	2	EA	2	6	12	1
2	30Z1443	FUSE 3A UL	1	EA	1	3	6	1
8	30Z1445	FUSE 10A UL	1	EA	1	3	6	1
9	30Z1446	STARTER CAP 2uF UL (NOTE-4 BELOW)	2	EA	2	6	12	
81	30Z1330	0.88uF 2500V CAPACITOR	1	EA	1	3	6	1
82	P30Z1230	60HZ TRANS MULTI TAP	1	EA	1	3	6	
84	31Z1255	CABLE GLAND BLACK PG21	1	EA	1	3	6	
85	31Z1256	NUT FOR CABLE GLAND PG21	1	EA	1	3	6	
Not Shown	30Z1455	TRANSFORMER LV CLASS 2	1	EA	1	3	6	1
Not Shown	31Z1266	PLUG & LEAD ASSY (SUBWAY)	1	EA	1	3	6	

eikon e3 XX - 220Volts 60HZ - MX - Unique Parts

2	30Z1443	FUSE 3A UL	1	EA	1	3	6	1
3	30Z0285	FUSEHOLDER 1 1/4in	2	EA	2	6	12	1
8	30Z1445	FUSE 10A UL	1	EA	1	3	6	1
9	30Z1446	STARTER CAP 2uF UL (NOTE-4 BELOW)	2	EA	2	6	12	
81	30Z1332	1.05uF CAPACITOR 2500V	1	EA	1	3	6	1
82	P30Z1230	60HZ TRANS MULTI TAP	1	EA	1	3	6	
84	31Z1255	CABLE GLAND BLACK PG21	1	EA	1	3	6	
85	31Z1256	NUT FOR CABLE GLAND PG21	1	EA	1	3	6	
Not Shown	30Z1455	TRANSFORMER LV CLASS 2	1	EA	1	3	6	1
Not Shown	31Z1266	PLUG & LEAD ASSY (SUBWAY)	1	EA	1	3	6	

eikon e3 XX - 220Volts 60HZ - SA - Unique Parts

2	30Z0217	FUSE 1in 10A HRC	1	EA	1	3	6	1
3	30Z0231	FUSEHOLDER 1in (13A)	2	EA	2	6	12	
8	30Z1207	FUSE 1in 3A HBC	1	EA	1	3	6	1
9	30Z1298	CAPACITOR - MOTOR START (NOTE-4 BELOW)	2	EA	2	6	12	
81	30Z1332	1.05uF CAPACITOR 2500V	1	EA	1	3	6	1
82	P30Z1230	60HZ TRANS MULTI TAP	1	EA	1	3	6	
84	31Z1255	CABLE GLAND BLACK PG21	1	EA	1	3	6	
85	31Z1256	NUT FOR CABLE GLAND PG21	1	EA	1	3	6	
Not Shown	DX0106	MAINS SUPPLY LEAD CE 1P (UK/EU)	1	EA	1	3	6	

Merrychef eikon e3 Oven

Recommended Parts List

Recommended Min Stock Holding & Service List

Service Manual Exploded View	Part Number	Description	Qty Per Oven	Unit	1-10 Ovens	11-50 Ovens	51-100 Ovens	Recommended Service List
eikon e3 XX - 220Volts 60HZ - TW - Unique Parts								
2	30Z0217	FUSE 1in 10A HRC	1	EA	1	3	6	1
3	30Z0231	FUSEHOLDER 1in (13A)	2	EA	2	6	12	
8	30Z1207	FUSE 1in 3A HBC	1	EA	1	3	6	1
9	30Z1298	CAPACITOR - MOTOR START (NOTE-4 BELOW)	2	EA	2	6	12	
81	30Z1332	1.05uF CAPACITOR 2500V	1	EA	1	3	6	1
82	P30Z1230	230V 60Hz TRANSFORMER	1	EA	1	3	6	
84	31Z1255	CABLE GLAND PG21	1	EA	1	3	6	
85	31Z1256	GLAND NUT PG21	1	EA	1	3	6	
Not Shown		MAINS SUPPLY LEAD	1	EA	1	3	6	

eikon e3 XX - 220Volts 60HZ - USA - Unique Parts

2	30Z1443	FUSE 3A UL	1	EA	1	3	6	1
3	30Z0285	FUSEHOLDER 1 1/4in	2	EA	2	6	12	
8	30Z1445	FUSE 10A UL	1	EA	1	3	6	1
9	30Z1446	STARTER CAP 2uF UL (NOTE-4 BELOW)	2	EA	2	6	12	
81	30Z1332	1.05uF CAPACITOR 2500V	1	EA	1	3	6	1
82	P30Z1230	60HZ TRANS MULTI TAP	1	EA	1	3	6	
84	31Z1255	CABLE GLAND BLACK PG21	1	EA	1	3	6	
85	31Z1256	NUT FOR CABLE GLAND PG21	1	EA	1	3	6	
Not Shown	30Z1439	RELAY V12 OMRON	1	EA	1	3	6	1
Not Shown	30Z1455	TRANSFORMER LV CLASS 2	1	EA	1	3	6	1
Not Shown	31Z1266	PLUG & LEAD ASSY (SUBWAY)	1	EA	1	3	6	

All above oven variations can be fitted with or without Catalytic Converters (see Main List for part no.)

eikon Service Kits

Not Shown	PSR110	TEN SPRING SERVICE KIT e3/e4/e4s/e5 & 402s		EA				
Not Shown	PSR113	TWO SPRING SERVICE KIT e3/e4/e4s/e5 & 402s		EA				1
Not Shown	PSX195	e3 RETROFIT RESISTOR KIT		EA				

e3 Accessories

34	40H0190	TEFLON SHEET		EA				
36	40H0249	CAST TURNTABLE DISK		EA				
37	40H0347	CAST COOKING CAROUSEL/TRAY		EA				
63	SR313	GENERIC HANDLE V2		EA				
Not Shown	31Z1234	PIZZA TRIVET RACK		EA				
Not Shown	32Z4043	e3 GASRONORM DISH 1/6 S/STEEL		EA				
Not Shown	40H0240	ROUND GRILL TRAY		EA				
Not Shown	DR0056	CHROMIUM PLATED STEEL RACK		EA				
Not Shown	DX0117	SQUARE BAKING TRAY		EA				

NOTES:

NOTE-1 In May 2012 Casework Changed - Order the following Part Numbers for **Pre-May 2012** Ovens:

DX0005 - Control Box, DX0020 - Top Panel, DX0021 - RHS Casework, DX0022 - LHS Casework & SX305 - Rear Casework Assy.

NOTE-2 In Oct 2013 Casework & Air Filter Changed - Order the following Part Numbers for **Post-May 2012 / Pre October 2013** Ovens: DX0179 - LHS Casework, DX0180 - RHS Casework & Air Filter Assy - SX328

NOTE-3 Post Oct 2013 Cavity Assy SX338 will **ONLY** Support; SX339 - Air Filter Assy, DX0219 & DX0220 - Casework & DX0235 - Reed Switch Bracket

NOTE-4 Only used with PSX209 - Hot Air Motor Assy

NOTE-5 Only used with Pre Oct 2013 Ovens

NOTE-6 In the event of a broken Hinge Spring, then PSR110 - Spring Replacement Kit is available with tool to replace up to five pairs of springs

Merrychef eikon e4 Oven - Exploded View

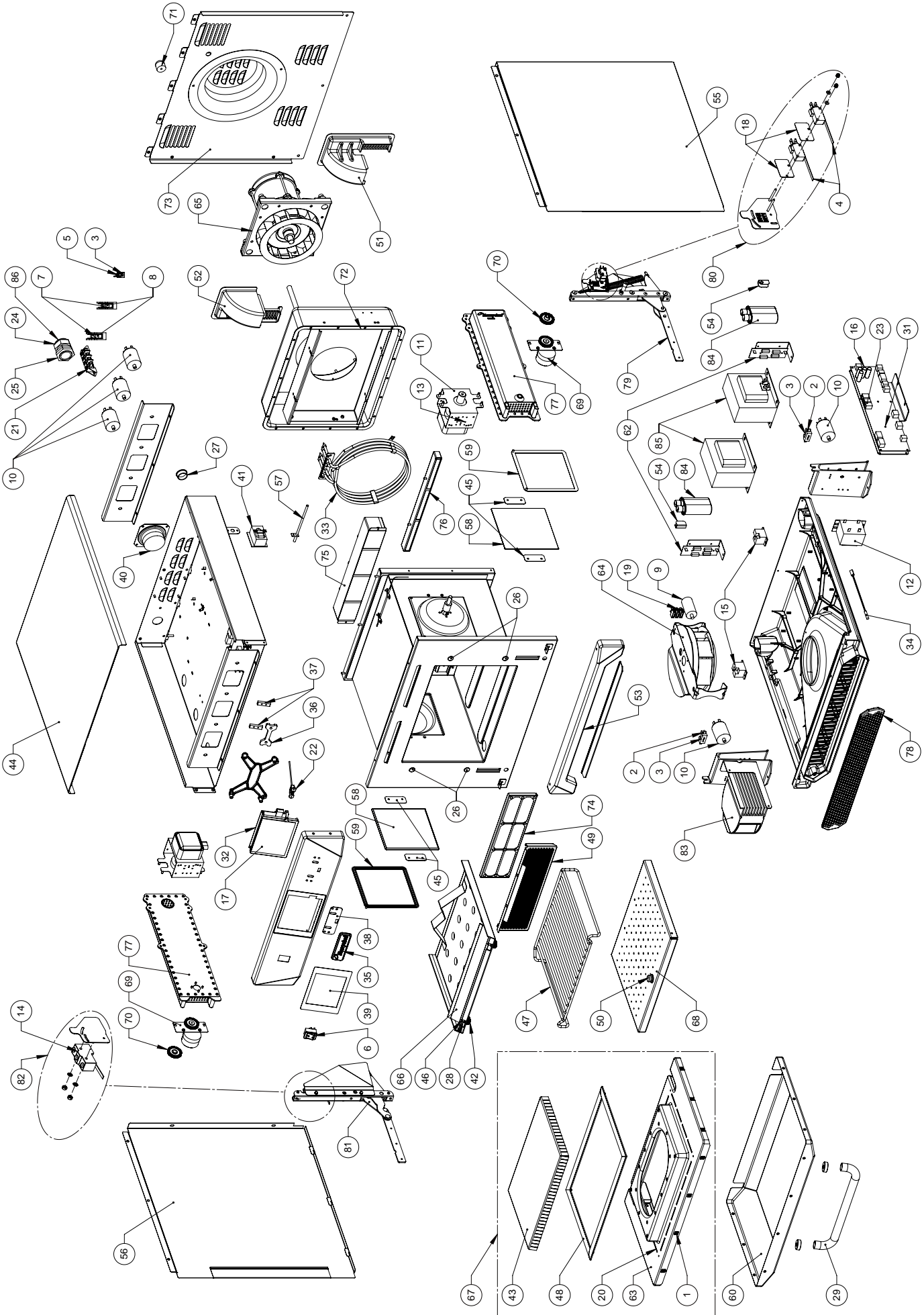

SPARES & REPLACEMENT

Merrychef eikon e4 Oven

Recommended Parts List

Recommended Min Stock Holding & Service List

Service Manual Exploded View	Part Number	Description	Qty Per Oven	Unit	1-10 Ovens	11-50 Ovens	51-100 Ovens	Recommended Service List
1	31Z4046	M3 CAGE NUT	10	EA	10	30	60	
4	30Z1459	MICROSWITCH	2	EA	2	6	12	2
6	30Z0503	SWITCH ON/OFF ROCKER DPST	1	EA	1	3	6	1
7	30Z1177	20 AMP LITTLEFUZE FLM020	2	EA	2	6	12	2
8	30Z1178	30A FUSE HOLDER	2	EA	2	6	12	
10	30Z1340	FILTER 16A SCREW MOUNT	5	EA	5	15	30	
13	30Z1427	MAGNETRON OVERHEAT STAT	2	EA	2	6	12	1
14	30Z1430	MICROSWITCH (LARGE)	1	EA	1	3	6	1
16	P30Z5000	SMART RELAY BOARD SRB	1	EA	1	3	6	1
17	P30Z5009	TOUCH SCREEN PCB	1	EA	1	3	6	1
18	31Z0115	INSULATOR PAD	2	EA	2	6	12	
20	31Z0186	SILASTIC BLACK (DOOR SEAL)		TUBE	0	0	0	1
21	31Z0477	4 WAY MAINS TERMINAL BLOCK	1	EA	1	3	6	
22	31Z0600	USB ADAPTOR MODULE	1	EA	1	3	6	
23	31Z0620	BTS UI SRB CABLE (WHITE)	1	EA	1	3	6	
24	31Z1255	PG21 CABLE GLAND BLACK	1	EA	1	3	6	
25	31Z1256	PG21 CABLE GLAND NUT	1	EA	1	3	6	
26	31Z1259	SHEET COVER CAP 12MM DIA	4	EA	4	12	24	
27	31Z1307	ETHERNET HOLE PLUG	1	EA	1	3	6	
28	31Z3154	M4x6 SET SCREW S/S A2 (IMPINGER)	2	EA	2	6	12	
29	DV0431	DOOR HANDLE	1	EA	1	3	6	
29 - 60	PSA2144	DOOR SKIN ASSY e4	1	EA	1	3	6	
29 - 60 - 67	PSA1138	DOOR ASSY (e4)	1	EA	1	3	6	
31	32Z7062	PERSONALITY MODULE SRB e4	1	EA	1	3	6	1
32	32Z7065	PERSONALITY MODULE BTS e4	1	EA	1	3	6	1
33	PSA1184	HEATER ASSEMBLY KIT e4	1	EA	1	3	6	
34	DR0006	REED SWITCH	1	EA	1	3	6	
35	DR0007	MERRYCHEF BADGE	1	EA	1	3	6	
36	DR0008	MERRYCHEF BADGE SLIDER	1	EA	1	3	6	
37	DR0009	MERRYCHEF BADGE GUIDE	1	EA	1	3	6	
38	DR0047	MERRYCHEF BADGE SEAL	1	EA	1	3	6	
39	DR0011	TOUCHSCREEN OVERLAY	1	EA	1	3	6	1
40	DR0021	HARMONISED SPEAKER	1	EA	1	3	6	
41	DR0042	OVERHEAT STAT SMALL	1	EA	1	3	6	1
42	DV0061	IMPINGER THUMB NUT	2	EA	2	6	12	
43	DV0168VIT	DOOR CHOKE PRESSED (VITREOUS)	1	EA	1	3	6	
44	DV0187	TOP PANEL (PRESSED)	1	EA	1	3	6	
45	DV0202	CERAMIC PLATE RETAINER	4	EA	4	12	24	
46	DV0239	IMPINGER FIXING - FAST THREAD	2	EA	2	6	12	
48	PSA3113	DOOR SEAL	1	EA	1	3	6	1
49	DV0752	GREASE FILTER HOUSING e4 (NOTE-1 BELOW)	1	EA	1	3	6	
50	DV0370	LOWER IMPINGER HANDLE	1	EA	1	3	6	
51	DV0816	e4s CAST RH DUCT	1	EA	1	3	6	
52	DV0403	CAST REAR DUCTING LH	1	EA	1	3	6	
53	DV0437	LOWER FASCIA FINISHED	1	EA	1	3	6	
54	DV0452	CAPACITOR CLIP	2	EA	2	6	12	
55	DV0840	e4s RH SIDE PANEL	1	EA	1	3	6	
56	DV0841	e4s LH SIDE PANEL	1	EA	1	3	6	
57	DV0661	THERMOCOUPLE (OVEN)	1	EA	1	3	6	1
58	DV0666	STIRRER COVER - CERAMIC	2	EA	2	6	12	2
59	DV0692	SEAL - CERAMIC COVER	2	EA	2	6	12	2
60	DV0700	DOOR SKIN	1	EA	1	3	6	
62	PSR109	DIODE REPLACEMENT KIT	2	EA	2	6	12	2
65	PSA1180	HOT AIR MOTOR ASSY	1	EA	1	3	6	
66	PSA2101	TOP IMPINGER PLATE SS	1	EA	1	3	6	
67	PSA246	DOOR + CHOKE ASSY (PRESSED)	1	EA	1	3	6	
68	PSA266	IMPINGER PLATE LOWER	1	EA	1	3	6	
70	PSA291	STIRRER ASSY (PINNED)	2	EA	2	6	12	
71	6004011	RUBBER FOOT O 40 x25	1	EA	1	3	6	
72	DV0648	CAVITY HOT BOX FINISHED	1	EA	1	3	6	
73	SA329	REAR PANEL ASSY	1	EA	1	3	6	
74	SA3126	GREASE FILTER CARTRIDGE (NOTE-1 BELOW)	1	EA	1	3	6	
75	SA351	UPPER CAT ASSY	1	EA	1	3	6	

Merrychef eikon e4 Oven

Recommended Parts List

Recommended Min Stock Holding & Service List

Service Manual Exploded View	Part Number	Description	Qty Per Oven	Unit	1-10 Ovens	11-50 Ovens	51-100 Ovens	Recommended Service List
76	SA353	LOWER CAT ASSY	1	EA	1	3	6	
77	SA374	CAST WAVEGUIDE ASSY	2	EA	2	6	12	
78	SA3127	AIR FILTER ASSY	1	EA	1	3	6	1
79 - 81	PSR101	EIKON DOOR HINGE KIT (NOTE-3 BELOW)	1	EA	1	3	6	
80 - 82	PSR102	EIKON M/SWITCH BRACKET KIT	1	EA	1	3	6	
Not Shown	30Z1457	eikon SRB 1.25A FUSE	1	EA	1	3	6	1
Not Shown	DR0045	SPEAKER WIRE	1	EA	1	3	6	
Not Shown	PSA3105	GASKET KIT	1	EA	1	3	6	
Not Numbered	SA312	VENT PIPE	1	EA	1	3	6	

eikon e4 230Volts 50Hz - UK/EU (GC//HE) - Unique Parts

2	30Z0217	FUSE 1in 10A HRC	2	EA	2	6	12	2
3	30Z0231	FUSEHOLDER 1in (13A)	3	EA	3	9	18	
5	30Z0394	FUSE 1in 7A HRC	1	EA	1	3	6	1
9	30Z1298	CAPACITOR - MOTOR START (COOLING)	1	EA	1	3	6	
11	P30Z1415	MAGNETRON 2M303H	2	EA	2	6	12	1
12	30Z1425	TRANSFORMER 240V 50/60Hz	1	EA	1	3	6	1
19	31Z0630	CHOCH BLOCK 3-WAY	1	EA	1	3	6	
64	PSA2195	COOLING FAN SUB-ASSEMBLY	1	EA	1	3	6	
69	PSA288	STIRRER MOTOR ASSY (PINNED)	2	EA	2	6	12	
83	30Z1319	MOTOR SPEED CONTROLLER (EU)	1	EA	1	3	6	
84	30Z1332	1.05uF 2500V CAPACITOR	2	EA	2	6	12	2
85	P30Z1413	230V 50Hz TRANSFORMER	2	EA	2	6	12	
86	SA225	MAINS LEAD ASSY (EU) 4-C	1	EA	1	3	6	
86	SA226	MAINS LEAD ASSY (UK) 3-C	1	EA	1	3	6	

eikon e4 230Volts 50Hz - UK/EU (UR) - Unique Parts

2	30Z0217	FUSE 1in 10A HRC	2	EA	2	6	12	2
3	30Z0231	FUSEHOLDER 1in (13A)	3	EA	3	9	18	
5	30Z0394	FUSE 1in 7A HRC	1	EA	1	3	6	1
9	30Z1298	CAPACITOR - MOTOR START (COOLING)	1	EA	1	3	6	
11	P30Z1415	MAGNETRON 2M303H	2	EA	2	6	12	1
12	30Z1425	TRANSFORMER 240V 50/60Hz	1	EA	1	3	6	1
15	30Z1440	RELAY 240V OMRON	1	EA	1	3	6	1
19	31Z0630	CHOCH BLOCK 3-WAY	1	EA	1	3	6	
64	PSA2195	COOLING FAN SUB-ASSEMBLY	1	EA	1	3	6	
69	PSA288	STIRRER MOTOR ASSY (PINNED)	2	EA	2	6	12	
83	30Z1319	MOTOR SPEED CONTROLLER (EU)	1	EA	1	3	6	
84	30Z1332	1.05uF 2500V CAPACITOR	2	EA	2	6	12	2
85	P30Z1413	230V 50Hz TRANSFORMER	2	EA	2	6	12	
86	SA2205	e4 3/PHASE MAINS LEAD	2	EA	2	6	12	

eikon e4 230Volts 50Hz - AP - Unique Parts

2	30Z0217	FUSE 1in 10A HRC	2	EA	2	6	12	2
3	30Z0231	FUSEHOLDER 1in (13A)	3	EA	3	9	18	
5	30Z0394	FUSE 1in 7A HRC	1	EA	1	3	6	1
9	30Z1298	CAPACITOR - MOTOR START (COOLING)	1	EA	1	3	6	
11	P30Z1415	MAGNETRON 2M303H	2	EA	2	6	12	1
12	30Z1425	TRANSFORMER 240V 50/60Hz	1	EA	1	3	6	1
19	31Z0630	CHOCH BLOCK 3-WAY	1	EA	1	3	6	
64	PSA2195	COOLING FAN SUB-ASSEMBLY	1	EA	1	3	6	
69	PSA288	STIRRER MOTOR ASSY (PINNED)	2	EA	2	6	12	
83	30Z1319	MOTOR SPEED CONTROLLER (EU)	1	EA	1	3	6	
84	30Z1332	1.05uF 2500V CAPACITOR	2	EA	2	6	12	2
85	P30Z1413	230V 50Hz TRANSFORMER	2	EA	2	6	12	
86	SA225	MAINS LEAD ASSY (EU) 4-C	1	EA	1	3	6	

Merrychef eikon e4 Oven

Recommended Parts List

Recommended Min Stock Holding & Service List

Service Manual Exploded View	Part Number	Description	Qty Per Oven	Unit	1-10 Ovens	11-50 Ovens	51-100 Ovens	Recommended Service List
------------------------------	-------------	-------------	--------------	------	------------	-------------	--------------	--------------------------

eikon e4 230Volts 50Hz - AZ (GC/GK) - Unique Parts

2	30Z0217	FUSE 1in 10A HRC	2	EA	2	6	12	2
3	30Z0231	FUSEHOLDER 1in (13A)	3	EA	3	9	18	
5	30Z0394	FUSE 1in 7A HRC	1	EA	1	3	6	1
9	30Z1298	CAPACITOR - MOTOR START (COOLING)	1	EA	1	3	6	
11	P30Z1415	MAGNETRON 2M303H	2	EA	2	6	12	
12	30Z1425	TRANSFORMER 240V 50/60Hz	1	EA	1	3	6	1
19	31Z0630	CHOCH BLOCK 3-WAY	1	EA	1	3	6	
64	PSA2195	COOLING FAN SUB-ASSEMBLY	1	EA	1	3	6	
69	PSA288	STIRRER MOTOR ASSY (PINNED)	2	EA	2	6	12	
83	30Z1319	MOTOR SPEED CONTROLLER (EU)	1	EA	1	3	6	
84	30Z1332	1.05uF 2500V CAPACITOR	2	EA	2	6	12	2
85	P30Z1413	230V 50Hz TRANSFORMER	2	EA	2	6	12	
86	SA225	MAINS LEAD ASSY (EU) 4-C	1	EA	1	3	6	
86	SR216	MAINS SUPPLY LEAD GK (AZ)	1	EA	1	3	6	

eikon e4 230Volts 50Hz - BO (DE) - Unique Parts

3	30Z0285	FUSEHOLDER 1 1/4in	3	EA	3	9	18	
2	30Z1445	FUSE 10A UL	2	EA	2	6	12	1
5	30Z1444	FUSE 7A UL	1	EA	1	3	6	1
9	30Z1446	STARTER CAP 2uF UL	1	EA	1	3	6	
11	P30Z1415	MAGNETRON 2M303H	2	EA	2	6	12	1
12	30Z1455	TRANSFORMER LV CLASS 2	1	EA	1	3	6	1
19	31Z0630	CHOCH BLOCK 3-WAY	1	EA	1	3	6	
64	PSA2195	COOLING FAN SUB-ASSEMBLY	1	EA	1	3	6	
69	PSA288	STIRRER MOTOR ASSY (PINNED)	2	EA	2	6	12	
83	30Z1319	MOTOR SPEED CONTROLLER (EU)	1	EA	1	3	6	
84	30Z1332	1.05uF 2500V CAPACITOR	2	EA	2	6	12	2
85	P30Z1413	230V 50Hz TRANSFORMER	2	EA	2	6	12	
86	SR229	MAINS SUPPLY LEAD DE	1	EA	1	3	6	

eikon e4 230Volts 50Hz - CN - Unique Parts

2	30Z0217	FUSE 1in 10A HRC	2	EA	2	6	12	2
3	30Z0231	FUSEHOLDER 1in (13A)	3	EA	3	9	18	
5	30Z0394	FUSE 1in 7A HRC	1	EA	1	3	6	1
9	30Z1298	CAPACITOR - MOTOR START (COOLING)	1	EA	1	3	6	
11	P30Z1415	MAGNETRON 2M303H	2	EA	2	6	12	1
12	30Z1425	TRANSFORMER 240V 50/60Hz	1	EA	1	3	6	1
19	31Z0630	CHOCH BLOCK 3-WAY	1	EA	1	3	6	
64	PSA2195	COOLING FAN SUB-ASSEMBLY	1	EA	1	3	6	
69	PSA288	STIRRER MOTOR ASSY (PINNED)	2	EA	2	6	12	
83	30Z1319	MOTOR SPEED CONTROLLER (EU)	1	EA	1	3	6	
84	30Z1332	1.05uF 2500V CAPACITOR	2	EA	2	6	12	2
85	P30Z1233	230V 50Hz TRANSFORMER	2	EA	2	6	12	
86	SA2111	MAINS CABLE ASSY 1P CHINA	1	EA	1	3	6	

eikon e4 230Volts 50Hz - DE - Unique Parts

2	30Z0217	FUSE 1in 10A HRC	2	EA	2	6	12	2
3	30Z0231	FUSEHOLDER 1in (13A)	3	EA	3	9	18	
5	30Z0394	FUSE 1in 7A HRC	1	EA	1	3	6	1
9	30Z1298	CAPACITOR - MOTOR START (COOLING)	1	EA	1	3	6	
11	P30Z1415	MAGNETRON 2M303H	2	EA	2	6	12	1
12	30Z1425	TRANSFORMER 240V 50/60Hz	1	EA	1	3	6	1
19	31Z0630	CHOCH BLOCK 3-WAY	1	EA	1	3	6	
64	PSA2195	COOLING FAN SUB-ASSEMBLY	1	EA	1	3	6	
69	PSA288	STIRRER MOTOR ASSY (PINNED)	2	EA	2	6	12	
83	30Z1319	MOTOR SPEED CONTROLLER (EU)	1	EA	1	3	6	
84	30Z1332	1.05uF 2500V CAPACITOR	2	EA	2	6	12	2
85	P30Z1413	230V 50Hz TRANSFORMER	2	EA	2	6	12	
86	SA225	MAINS LEAD ASSY (EU) 4-C	1	EA	1	3	6	

Merrychef eikon e4 Oven

Recommended Parts List

Recommended Min Stock Holding & Service List

Service Manual Exploded View	Part Number	Description	Qty Per Oven	Unit	1-10 Ovens	11-50 Ovens	51-100 Ovens	Recommended Service List
------------------------------	-------------	-------------	--------------	------	------------	-------------	--------------	--------------------------

eikon e4 200V 50Hz - JP - Unique Parts

2	30Z0217	FUSE 1in 10A HRC	2	EA	2	6	12	2
3	30Z0231	FUSEHOLDER 1in (13A)	3	EA	3	9	18	
5	30Z0394	FUSE 1in 7A HRC	1	EA	1	3	6	1
9	30Z1466	STARTER CAP UL 3uF - MOTOR START (COOLING)	1	EA	1	3	6	
11	P30Z1525	MAGNETRON - JAPAN	2	EA	2	6	12	1
12	30Z1425	TRANSFORMER 240V 50/60Hz	1	EA	1	3	6	1
19	31Z0631	CHOCH BLOCK 4-WAY	1	EA	1	3	6	
64	PSA2153	200V COOLING FAN SUB-ASSEMBLY	1	EA	1	3	6	
69	PSA2154	200V STIRRER MOTOR ASSY (PINNED)	2	EA	2	6	12	
83	30Z1319	MOTOR SPEED CONTROLLER (EU)	1	EA	1	3	6	
84	30Z1332	1.05uF 2500V CAPACITOR	2	EA	2	6	12	2
85	P30Z1463	200V 50HZ TRANSFORMER (50Hz ONLY)	2	EA	2	6	12	
86	SA2110	MAINS CABLE ASSY DE (JP)	1	EA	1	3	6	

eikon e4 220Volts 60Hz - BR (DF) - Unique Parts

2	30Z0217	FUSE 1in 10A HRC	2	EA	2	6	12	2
3	30Z0231	FUSEHOLDER 1in (13A)	3	EA	3	9	18	
5	30Z0394	FUSE 1in 7A HRC	1	EA	1	3	6	1
9	30Z1298	CAPACITOR - MOTOR START (COOLING)	1	EA	1	3	6	
11	P30Z1415	MAGNETRON 2M303H	2	EA	2	6	12	1
12	30Z1425	TRANSFORMER 240V 50/60Hz	1	EA	1	3	6	1
19	31Z0630	CHOCH BLOCK 3-WAY	1	EA	1	3	6	
64	PSA2195	COOLING FAN SUB-ASSEMBLY	1	EA	1	3	6	
69	PSA288	STIRRER MOTOR ASSY (PINNED)	2	EA	2	6	12	
83	30Z1319	MOTOR SPEED CONTROLLER (EU)	1	EA	1	3	6	
84	30Z1330	0.88uF 2500V CAPACITOR	2	EA	2	6	12	2
85	P30Z1230	60HZ TRANS MULTI TAP	2	EA	2	6	12	
86	31Z1266	PLUG & LEAD ASSY (SUBWAY)	1	EA	1	3	6	

eikon e4 220Volts 60Hz - BR (DJ) - Unique Parts

3	30Z0285	FUSEHOLDER 1 1/4in	3	EA	3	9	18	
2	30Z1445	FUSE 10A UL	2	EA	2	6	12	2
5	30Z1444	FUSE 7A UL	1	EA	1	3	6	1
9	30Z1446	STARTER CAP 2uF UL	1	EA	1	3	6	
11	P30Z1415	MAGNETRON 2M303H	2	EA	2	6	12	1
12	30Z1455	TRANSFORMER LV CLASS 2	1	EA	1	3	6	1
19	31Z0630	CHOCH BLOCK 3-WAY	1	EA	1	3	6	
64	PSA2195	COOLING FAN SUB-ASSEMBLY	1	EA	1	3	6	
69	PSA288	STIRRER MOTOR ASSY (PINNED)	2	EA	2	6	12	
83	30Z1319	MOTOR SPEED CONTROLLER (EU)	1	EA	1	3	6	
84	30Z1330	0.88uF 2500V CAPACITOR	2	EA	2	6	12	2
85	P30Z1230	60HZ TRANS MULTI TAP	2	EA	2	6	12	
86	SR228	MAINS SUPPLY LEAD DJ	1	EA	1	3	6	

eikon e4 200V 60Hz - JP - Unique Parts

2	30Z0217	FUSE 1in 10A HRC	2	EA	2	6	12	2
3	30Z0231	FUSEHOLDER 1in (13A)	3	EA	3	9	18	
5	30Z0394	FUSE 1in 7A HRC	1	EA	1	3	6	1
9	30Z1466	STARTER CAP UL 3uF - MOTOR START (COOLING)	1	EA	1	3	6	
11	P30Z1525	MAGNETRON - JAPAN	2	EA	2	6	12	1
12	30Z1425	TRANSFORMER 240V 50/60Hz	1	EA	1	3	6	1
19	31Z0631	CHOCH BLOCK 4-WAY	1	EA	1	3	6	
64	PSA2153	200V COOLING FAN SUB-ASSEMBLY	1	EA	1	3	6	
69	PSA2154	200V STIRRER MOTOR ASSY (PINNED)	2	EA	2	6	12	
83	30Z1319	MOTOR SPEED CONTROLLER (EU)	1	EA	1	3	6	
84	30Z1332	1.05uF 2500V CAPACITOR	2	EA	2	6	12	2
85	P30Z1464	200V 60HZ TRANSFORMER (60Hz ONLY)	2	EA	2	6	12	
86	SA2110	MAINS CABLE ASSY DE (JP)	1	EA	1	3	6	

Merrychef eikon e4 Oven

Recommended Parts List

Recommended Min Stock Holding & Service List

Service Manual Exploded View	Part Number	Description	Qty Per Oven	Unit	1-10 Ovens	11-50 Ovens	51-100 Ovens	Recommended Service List
eikon e4 220Volts 60Hz - KR (HE) - Unique Parts								
2	30Z0217	FUSE 1in 10A HRC	2	EA	2	6	12	2
3	30Z0231	FUSEHOLDER 1in (13A)	3	EA	3	9	18	
5	30Z0394	FUSE 1in 7A HRC	1	EA	1	3	6	1
9	30Z1298	CAPACITOR - MOTOR START (COOLING)	1	EA	1	3	6	
11	P30Z1415	MAGNETRON 2M303H	2	EA	2	6	12	1
12	30Z1425	TRANSFORMER 240V 50/60Hz	1	EA	1	3	6	1
19	31Z0630	CHOCH BLOCK 3-WAY	1	EA	1	3	6	
64	PSA2195	COOLING FAN SUB-ASSEMBLY	1	EA	1	3	6	
69	PSA288	STIRRER MOTOR ASSY (PINNED)	2	EA	2	6	12	
83	30Z1319	MOTOR SPEED CONTROLLER (EU)	1	EA	1	3	6	
84	30Z1330	0.88uF 2500V CAPACITOR	2	EA	2	6	12	2
85	P30Z1230	60HZ TRANS MULTI TAP	2	EA	2	6	12	
86	SA226	MAINS LEAD ASSY (UK) 3-C	1	EA	1	3	6	

eikon e4 208-240Volts 60Hz - LA (DF) - Unique Parts								
3	30Z0285	FUSEHOLDER 1 1/4in	3	EA	3	9	18	
2	30Z1445	FUSE 10A UL	2	EA	2	6	12	2
5	30Z1444	FUSE 7A UL	1	EA	1	3	6	1
9	30Z1446	STARTER CAP 2uF UL	1	EA	1	3	6	
11	P30Z1415	MAGNETRON 2M303H	2	EA	2	6	12	1
12	30Z1455	TRANSFORMER LV CLASS 2	1	EA	1	3	6	1
15	30Z1439	RELAY 12V OMRON	2	EA	2	6	12	2
19	31Z0630	CHOCH BLOCK 3-WAY	1	EA	1	3	6	
64	PSA2195	COOLING FAN SUB-ASSEMBLY	1	EA	1	3	6	
69	PSA288	STIRRER MOTOR ASSY (PINNED)	2	EA	2	6	12	
83	30Z1293	MOTOR SPEED CONTROLLER (USA)	1	EA	1	3	6	
84	30Z1330	0.88uF 2500V CAPACITOR	2	EA	2	6	12	2
85	P30Z1230	60HZ TRANS MULTI TAP	2	EA	2	6	12	
86	31Z1266	PLUG & LEAD ASSY (SUBWAY)	1	EA	1	3	6	

eikon e4 220Volts 60Hz - LA (DF) - Unique Parts								
3	30Z0285	FUSEHOLDER 1 1/4in	3	EA	3	9	18	
2	30Z1445	FUSE 10A UL	2	EA	2	6	12	2
5	30Z1444	FUSE 7A UL	1	EA	1	3	6	1
9	30Z1446	STARTER CAP 2uF UL	1	EA	1	3	6	
11	P30Z1415	MAGNETRON 2M303H	2	EA	2	6	12	1
12	30Z1455	TRANSFORMER LV CLASS 2	1	EA	1	3	6	1
19	31Z0630	CHOCH BLOCK 3-WAY	1	EA	1	3	6	
64	PSA2195	COOLING FAN SUB-ASSEMBLY	1	EA	1	3	6	
69	PSA288	STIRRER MOTOR ASSY (PINNED)	2	EA	2	6	12	
83	30Z1319	MOTOR SPEED CONTROLLER (EU)	1	EA	1	3	6	
84	30Z1330	0.88uF 2500V CAPACITOR	2	EA	2	6	12	2
85	P30Z1230	60HZ TRANS MULTI TAP	2	EA	2	6	12	
86	31Z1266	PLUG & LEAD ASSY (SUBWAY)	1	EA	1	3	6	

eikon e4 220Volts 60Hz - MX - Unique Parts								
3	30Z0285	FUSEHOLDER 1 1/4in	3	EA	3	9	18	
2	30Z1445	FUSE 10A UL	2	EA	2	6	12	2
5	30Z1444	FUSE 7A UL	1	EA	1	3	6	1
9	30Z1446	STARTER CAP 2uF UL	1	EA	1	3	6	
11	P30Z1415	MAGNETRON 2M303H	2	EA	2	6	12	1
12	30Z1455	TRANSFORMER LV CLASS 2	1	EA	1	3	6	1
19	31Z0630	CHOCH BLOCK 3-WAY	1	EA	1	3	6	
64	PSA2195	COOLING FAN SUB-ASSEMBLY	1	EA	1	3	6	
69	PSA288	STIRRER MOTOR ASSY (PINNED)	2	EA	2	6	12	
83	30Z1293	MOTOR SPEED CONTROLLER (USA)	1	EA	1	3	6	
84	30Z1330	0.88uF 2500V CAPACITOR	2	EA	2	6	12	2
85	P30Z1230	60HZ TRANS MULTI TAP	2	EA	2	6	12	
86	31Z1266	PLUG & LEAD ASSY (SUBWAY)	1	EA	1	3	6	

Merrychef eikon e4 Oven

Recommended Parts List

Recommended Min Stock Holding & Service List

Service Manual Exploded View	Part Number	Description	Qty Per Oven	Unit	1-10 Ovens	11-50 Ovens	51-100 Ovens	Recommended Service List
eikon e4 220Volts 60Hz - PH (MH) - Unique Parts								
2	30Z0217	FUSE 1in 10A HRC	2	EA	2	6	12	2
3	30Z0231	FUSEHOLDER 1in (13A)	3	EA	3	9	18	
5	30Z0394	FUSE 1in 7A HRC	1	EA	1	3	6	1
9	30Z1298	CAPACITOR - MOTOR START (COOLING)	1	EA	1	3	6	
11	P30Z1415	MAGNETRON 2M303H	2	EA	2	6	12	1
12	30Z1425	TRANSFORMER 240V 50/60Hz	1	EA	1	3	6	1
19	31Z0630	CHOCH BLOCK 3-WAY	1	EA	1	3	6	
64	PSA2195	COOLING FAN SUB-ASSEMBLY	1	EA	1	3	6	
69	PSA288	STIRRER MOTOR ASSY (PINNED)	2	EA	2	6	12	
83	30Z1319	MOTOR SPEED CONTROLLER (EU)	1	EA	1	3	6	
84	30Z1330	0.88uF 2500V CAPACITOR	2	EA	2	6	12	2
85	P30Z1230	60HZ TRANS MULTI TAP	2	EA	2	6	12	
86	SA2128	MAINS CABLE ASSY PHILIPPINESS	1	EA	1	3	6	

eikon e4 220Volts 60Hz - SA (HE) - Unique Parts								
2	30Z0217	FUSE 1in 10A HRC	2	EA	2	6	12	2
3	30Z0231	FUSEHOLDER 1in (13A)	3	EA	3	9	18	
5	30Z0394	FUSE 1in 7A HRC	1	EA	1	3	6	1
9	30Z1298	CAPACITOR - MOTOR START (COOLING)	1	EA	1	3	6	
11	P30Z1415	MAGNETRON 2M303H	2	EA	2	6	12	1
12	30Z1425	TRANSFORMER 240V 50/60Hz	1	EA	1	3	6	1
19	31Z0630	CHOCH BLOCK 3-WAY	1	EA	1	3	6	
64	PSA2195	COOLING FAN SUB-ASSEMBLY	1	EA	1	3	6	
69	PSA288	STIRRER MOTOR ASSY (PINNED)	2	EA	2	6	12	
83	30Z1319	MOTOR SPEED CONTROLLER (EU)	1	EA	1	3	6	
84	30Z1330	0.88uF 2500V CAPACITOR	2	EA	2	6	12	2
85	P30Z1230	60HZ TRANS MULTI TAP	2	EA	2	6	12	
86	SA226	MAINS LEAD ASSY (UK) 3-C	1	EA	1	3	6	

eikon e4 220Volts 60Hz - TW (DZ/NZ) - Unique Parts								
2	30Z0217	FUSE 1in 10A HRC	2	EA	2	6	12	2
3	30Z0231	FUSEHOLDER 1in (13A)	3	EA	3	9	18	
5	30Z0394	FUSE 1in 7A HRC	1	EA	1	3	6	1
9	30Z1298	CAPACITOR - MOTOR START (COOLING)	1	EA	1	3	6	
11	P30Z1415	MAGNETRON 2M303H	2	EA	2	6	12	1
12	30Z1425	TRANSFORMER 240V 50/60Hz	1	EA	1	3	6	1
19	31Z0630	CHOCH BLOCK 3-WAY	1	EA	1	3	6	
64	PSA2195	COOLING FAN SUB-ASSEMBLY	1	EA	1	3	6	
69	PSA288	STIRRER MOTOR ASSY (PINNED)	2	EA	2	6	12	
83	30Z1319	MOTOR SPEED CONTROLLER (EU)	1	EA	1	3	6	
84	30Z1330	0.88uF 2500V CAPACITOR	2	EA	2	6	12	2
85	P30Z1230	60HZ TRANS MULTI TAP	2	EA	2	6	12	
86	SA2146	MAINS LEAD DZ e4	1	EA	1	3	6	
86	SA2147	MAINS LEAD NZ e4	1	EA	1	3	6	

eikon e4 208V-240V 60Hz - USA - Unique Parts								
3	30Z0285	FUSEHOLDER 1 1/4in	3	EA	3	9	18	
2	30Z1445	FUSE 10A UL	2	EA	2	6	12	2
5	30Z1444	FUSE 7A UL	1	EA	1	3	6	1
9	30Z1446	STARTER CAP 2uF UL	1	EA	1	3	6	
11	P30Z1415	MAGNETRON 2M303H	2	EA	2	6	12	1
12	30Z1455	TRANSFORMER LV CLASS 2	1	EA	1	3	6	1
15	30Z1439	OMRON RELAY 12V	1	EA	1	3	6	1
19	31Z0630	CHOCH BLOCK 3-WAY	1	EA	1	3	6	
64	PSA2195	COOLING FAN SUB-ASSEMBLY	1	EA	1	3	6	
69	PSA288	STIRRER MOTOR ASSY (PINNED)	2	EA	2	6	12	
83	30Z1293	MOTOR SPEED CONTROLLER (USA)	1	EA	1	3	6	
84	30Z1330	0.88uF 2500V CAPACITOR	2	EA	2	6	12	2
85	P30Z1230	60HZ TRANS MULTI TAP	2	EA	2	6	12	
86	31Z1266	PLUG & LEAD ASSY (SUBWAY)	1	EA	1	3	6	
86	DX0104	MAINS SUPPLY LEAD D (US)	1	EA	1	3	6	

Merrychef eikon e4 Oven

Recommended Parts List

Recommended Min Stock Holding & Service List

Service Manual Exploded View	Part Number	Description	Qty Per Oven	Unit	1-10 Ovens	11-50 Ovens	51-100 Ovens	Recommended Service List
------------------------------	-------------	-------------	--------------	------	------------	-------------	--------------	--------------------------

eikon e4 Upgrade Kits - All Models

Not Shown	PSA1189	REPLACEMENT SCREW SET KIT		EA				
Not Shown	PSA1192	GREASE FILTER UPGRADE KIT (NOTE-1 BELOW)		EA				
Not Shown	PSA1193	IMPINGER RESTING PLATE KIT		EA				
Not Shown	PSA1217	LOW NOISE MODIFICATION KIT e4 (NOTE-2 BELOW)		EA				
Not Shown	PSR110	TEN SPRING SERVICE KIT e3/e4/e4s/e5 & 402s		EA				
Not Shown	PSR113	TWO SPRING SERVICE KIT e3/e4/e4s/e5 & 402s		EA				1

e4 Accessories

47	DV0275	RACK V3	1	EA				
Not Shown	32Z4028	HALF SIZE GASTRONOM DISH	1	EA				
Not Shown	32Z4031	BREAD BASKET (WEAVED)		EA				
Not Shown	32Z4032	HASH-BROWN WEAVE BASKET		EA				
Not Shown	40H0240	ALUMINIUM PTFE TRAY		EA				
Not Shown	DV0343	GRIDDLE CARRIER (FOR PSA1108)		EA				
Not Shown	DV0344	GRIDDLE CARRIER HANDLE (FOR PSA1108)		EA				
Not Shown	DX0117	SQUARE BAKING TRAY	1	EA				
Not Shown	PSA1108	GRIDDLE ACCESSORY PACK		EA				
Not Shown	PSA1248	COOK PLATE KIT - USA		EA				
Not Shown	PSA299	4PACK GRIDDLE PLATES (FOR PSA1108)		EA				
Not Shown	SR310	LARGE PADDLE ALUM ASSY		EA				

NOTES:

NOTE-1 From November 2011 DV0752 & SA3126 Replaced DV0366 & SA340 Grease Filter Arrangement

NOTE-2 Upgrade option for ovens pre March 2013

NOTE-3 In the event of a broken Hinge Spring, then PSR113 - Two Spring Service Kit or PSR110 - Ten Spring Service Kit are available with tool - NOTE Springs MUST be replaced in Pairs.

Merrychef eikon e4s Oven - Exploded View

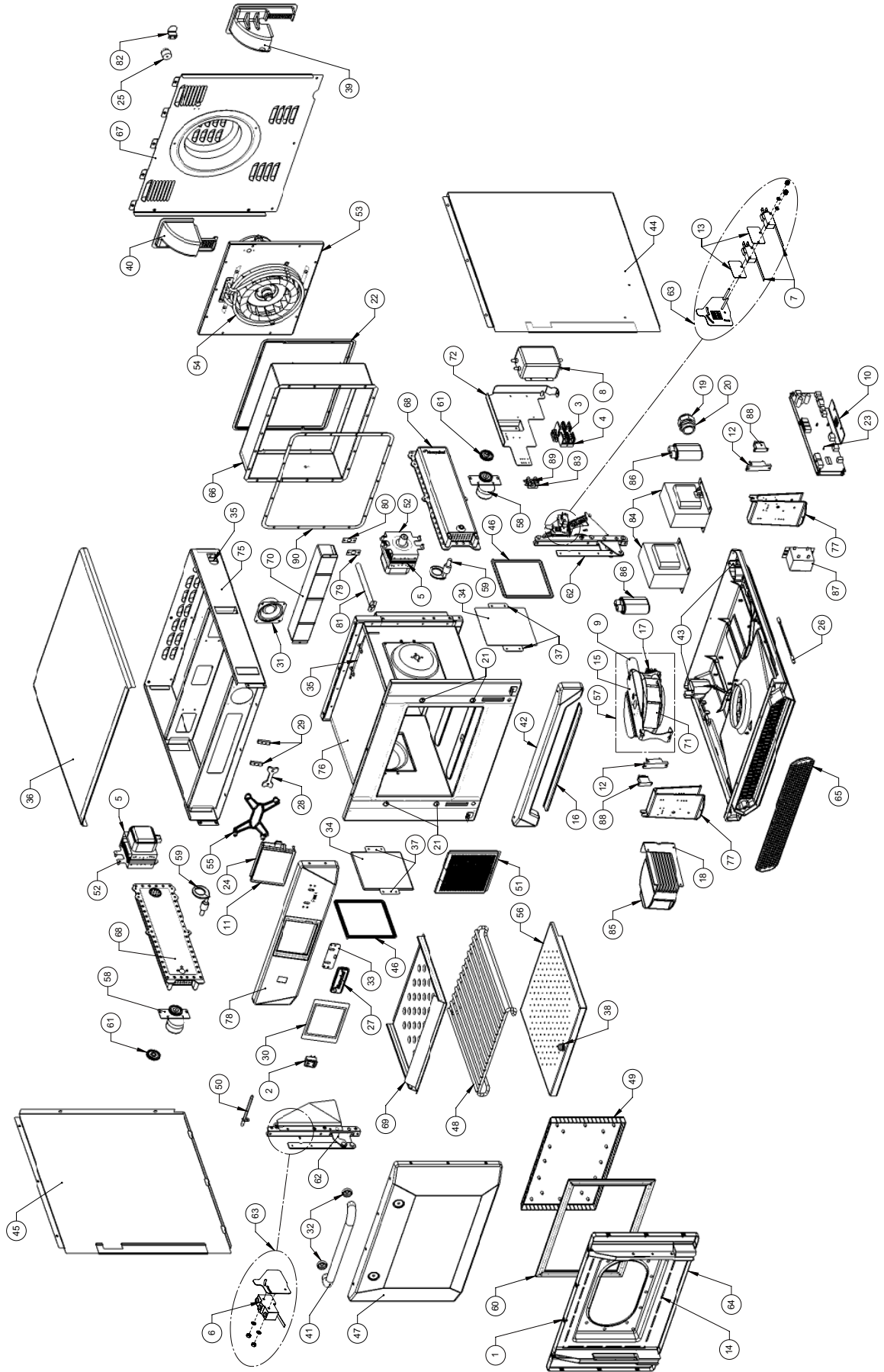

SPARES & REPLACEMENT

Merrychef eikon e4s Oven

Recommended Parts List

Recommended Min Stock Holding & Service List

Service Manual Exploded View	Part Number	Description	Qty Per Oven	Unit	1-10 Ovens	11-50 Ovens	51-100 Ovens	Service Centre Kit	e4s Unique Parts over e4
1	31Z4046	M3 CAGE NUT	10	EA	10	30	60		
2	30Z0503	SWITCH ON/OFF ROCKER DPST	1	EA	1	3	6	1	
3	30Z1535	25 AMP LITTLEFUSE FLM025	2	EA	2	6	12	2	2
4	30Z1178	30A FUSE HOLDER	2	EA	2	6	12		
5	30Z1427	MAGNETRON OVERHEAT STAT	2	EA	2	6	12	1	
6	30Z1430	MICROSWITCH (LARGE)	1	EA	1	3	6	1	
7	30Z1459	MICROSWITCH	2	EA	2	6	12	2	
10	30Z5011	CONTROL PCB e4s SRB	1	EA	1	3	6	1	1
11 - 55	P30Z5009	eikon TOUCH SCREEN & PCB	1	EA	1	3	6	1	
12	PSR109	DIODE REPLACEMENT KIT	2	EA	2	6	12	2	2
13	31Z0115	INSULATOR PAD	2	EA	2	6	12		
14	31Z0186	SILASTIC BLACK (DOOR SEAL)		TUBE	0	0	0	1	
21	31Z1259	SHEET COVER CAP 12MM DIA	4	EA	4	12	24		
22 - 79 - 90	PSA1243	e4s GASKET KIT	1	EA	1	3	6		1
23	32Z7075	PERSONALITY MODULE SRB e4s	1	EA	1	3	6	1	1
24	32Z7076	PERSONALITY MODULE QTS e4s	1	EA	1	3	6	1	1
25	6004011	RUBBER FOOT 0 40 X 25	1	EA	1	3	6		
26	DR0006	REED SWITCH	1	EA	1	3	6	1	
27	DR0007	MERRYCHEF BADGE	1	EA	1	3	6		
28	DR0008	MERRYCHEF BADGE SLIDER	1	EA	1	3	6		
29	DR0009	MERRYCHEF BADGE GUIDE	2	EA	2	6	12		
30	DR0011	TOUCHSCREEN OVERLAY	1	EA	1	3	6	1	
31	DR0021	HARMONISED SPEAKER	1	EA	1	3	6		
32	DR0030	HANDLE SPACER	2	EA	2	6	12		
33	DR0047	MERRYCHEF BADGE SEAL	1	EA	1	3	6		
34	DR0060	STIRRER COVER - CERAMIC	2	EA	2	6	12	2	2
35	DR0079	OVEN TEMP STAT	1	EA	1	3	6	1	1
36	DV0187	TOP PANEL (PRESSED)	1	EA	1	3	6		
37	DV0202	CERAMIC PLATE RETAINER	4	EA	4	12	24		
38	DV0370	LOWER IMPINGER HANDLE	1	EA	1	3	6		
39	DV0816	e4s CAST RH DUCT	1	EA	1	3	6		1
40	DV0403	CAST REAR DUCTING LH	1	EA	1	3	6		
41	DV0431	DOOR HANDLE	1	EA	1	3	6		
42	DV0437	LOWER FASCIA FINISHED	1	EA	1	3	6		
43	DV0452	CAPACITOR CLIP	2	EA	2	6	12		
44	DV0840	e4s RH SIDE PANEL	1	EA	1	3	6		1
45	DV0841	e4s LH SIDE PANEL	1	EA	1	3	6		1
46	DV0692	SEAL - CERAMIC COVER	2	EA	2	6	12	2	
47 - 41 - 32	PSA2144	DOOR SKIN ASSY e4	1	EA	1	3	6		
49	DV0168VIT	DOOR CHOKE PRESSED VITREOUS	1	EA	1	3	6		
50	DV0815	e4s CAVITY THERMOCOUPLE	1	EA	1	3	6	1	1
51	SA3153	e4s AIR DIFFUSER ASSY	1	EA	1	3	6		1
52	P30Z1415	MAGNETRON 2M303H	2	EA	2	6	12	1	
54 - 22 - 90	PSA1242	e4s HEATER ASSEMBLY KIT	1	EA	1	3	6		1
56	PSA2191	e4s IMPINGER PLATE LOWER	1	EA	1	3	6		1
57	PSA2195	e4s COOLING FAN ASSEMBLY	1	EA	1	3	6		1
58	PSA288	STIRRER MOTOR ASSY (PINNED)	2	EA	2	6	12		
59	PSA291	STIRRER ASSY (PINNED)	2	EA	2	6	12		
60	PSA3113	DOOR SEAL	1	EA	1	3	6	1	
62	PSA2214	e4s DOOR HINGE KIT (NOTE-1 BELOW)		EA	0	0	0		1
63	PSR102	EIKON M/SWITCH BRACKET KIT		EA	0	0	0		
64 - 60 - 49	PSA2197	e4s DOOR+CHOKE ASSY	1	EA	1	3	6		1
64-60-49-47-41	PSA1215	e4s DOOR ASSEMBLY (COMPLETE)	1	EA	1	3	6		1
65	SA3127	AIR FILTER ASSY e4	1	EA	1	3	6	1	
66	DV0773	CAVITY HOT BOX FINISHED	1	EA	1	3	6		1
67	SA3134	REAR PANEL WELDED ASSY e4s	1	EA	1	3	6		1
68	PSA2201	e4s WAVEGUIDE ASSY	2	EA	2	6	12		2
69	PSA1240	e4s UPPER IMPINGER PLATE	1	EA	1	3	6		1
70	SA3151	e4s UPPER CAT ASSY	1	EA	1	3	6		1
73	31Z1368	e4s FAN WHEEL	1	EA	1	3	6		
73 - 74 - 53 - 22	PSA1241	e4s HOT AIR MOTOR ASSY KIT	1	EA	1	3	6		1
76	SA3114	e4s CAVITY ASSY	1	EA	1	3	6		
78	DV0838	CONTROL PANEL e4/e4s	1	EA	1	3	6		
81	SA3132	e4s CAVITY INNER STEAM PIPE	1	EA	1	3	6		1
85	30Z1521	e4s MOTOR SPEED CONTROLLER	1	EA	1	3	6		1
Not Shown	30Z1457	eikon SRB 1.25A FUSE	1	EA	1	3	6	1	
Not Shown	31Z0600	USB ADAPTOR MODULE	1	EA	1	3	6		
Not Shown	31Z0620	BTS UI SRB CABLE (WHITE)	1	EA	1	3	6		
Not Shown	31Z1252	BOLT M4 X 10 HEX HD FLANGE SS	8	EA	8	24	48		
Not Shown	31Z1255	PG21 CABLE GLAND BLACK	1	EA	1	3	6		

Merrychef eikon e4s Oven

Recommended Parts List

Recommended Min Stock Holding & Service List

Service Manual Exploded View	Part Number	Description	Qty Per Oven	Unit	1-10 Ovens	11-50 Ovens	51-100 Ovens	Service Centre Kit	e4s Unique Parts over e4
Not Shown	31Z1256	PG21 CABLE GLAND NUT	1	EA	1	3	6		
Not Shown	DV0703	BASE LIP	1	EA	1	3	6		
Not Shown	DV0830	e4s SPEAKER WIRE	1	EA	1	3	6		
Not Shown	SA3136	CAVITY WRAP KIT	1	EA	1	3	6		1
Not Numbered	SA3150	e4s LOWER CAT ASSY	1	EA	1	3	6		1

eikon e4s 230Volts 50Hz - UK/EU - Single Phase - Unique Parts

8	30Z1488	e4s MAINS FILTER	1	EA	1	3	6		1
83	30Z0231	FUSEHOLDER 1in (13A)	3	EA	3	9	18		
84	P30Z1413	230V 50Hz TRANSFORMER	2	EA	2	6	12		
86	30Z1431	1.2uF 2500V CAPACITOR	2	EA	2	6	12	2	2
87	30Z1425	TRANSFORMER 240V 50/60Hz	1	EA	1	3	6	1	
89	30Z0456	FUSE 1in 13A HRC	3	EA	3	9	18	3	
Not Shown	SA2209	e4s 2P PLUG - 1P LEAD HC (UK)	1	EA	1	3	6		1
Not Shown	SR234	e4s SINGLE PHASE CABLE (EU)	1	EA	1	3	6		1

eikon e4s 230Volts 50Hz - EU - Twin Phase - Unique Parts

8	30Z1534	e4s MAINS FILTER 20A	2	EA	2	6	12		2
83	30Z0231	FUSEHOLDER 1in (13A)	3	EA	3	9	18		
84	P30Z1413	230V 50Hz TRANSFORMER	2	EA	2	6	12		
86	30Z1431	1.2uF 2500V CAPACITOR	2	EA	2	6	12	2	2
87	30Z1425	TRANSFORMER 240V 50/60Hz	1	EA	1	3	6	1	
89	30Z0456	FUSE 1in 13A HRC	3	EA	3	9	18	3	
Not Shown	SR239	e4s MAINS CABLE 2P+N+E	1	EA	1	3	6		1

eikon e4s 230Volts 50Hz - AP - Unique Parts

8	30Z1534	e4s MAINS FILTER 20A	2	EA	2	6	12		2
83	30Z0231	FUSEHOLDER 1in (13A)	3	EA	3	9	18		
84	P30Z1413	230V 50Hz TRANSFORMER	2	EA	2	6	12		
86	30Z1431	1.2uF 2500V CAPACITOR	2	EA	2	6	12	2	
87	30Z1425	TRANSFORMER 240V 50/60Hz	1	EA	1	3	6	1	
89	30Z0456	FUSE 1in 13A HRC	3	EA	3	9	18	3	
Not Shown	SR239	e4s MAINS CABLE 2P+N+E	1	EA	1	3	6		1

eikon e4s 230Volts 50Hz - AZ - Unique Parts

8	30Z1534	e4s MAINS FILTER 20A	2	EA	2	6	12		2
83	30Z0231	FUSEHOLDER 1in (13A)	3	EA	3	9	18		
84	P30Z1413	230V 50Hz TRANSFORMER	2	EA	2	6	12		
86	30Z1431	1.2uF 2500V CAPACITOR	2	EA	2	6	12	2	
87	30Z1425	TRANSFORMER 240V 50/60Hz	1	EA	1	3	6	1	
89	30Z0456	FUSE 1in 13A HRC	3	EA	3	9	18	3	
Not Shown	SR233	e4s MAINS CABLE AZ 5P	1	EA	1	3	6		

eikon e4s 220V 60Hz - BR - Unique Parts

8	30Z1488	e4s MAINS FILTER	1	EA	1	3	6		1
83	30Z0285	FUSEHOLDER 1 1/4in (13A)	3	EA	3	9	18		
84	P30Z1230	60HZ TRANS MULTI TAP	2	EA	2	6	12		
86	30Z1331	1.00uF 2500V CAPACITOR	2	EA	2	6	12	2	
87	30Z1455	TRANSFORMER LV CLASS 2	1	EA	1	3	6	1	
89	30Z1507	e4s USA 12A FUSE SLOW/B	3	EA	3	9	18	3	3
Not Shown	SR219	MAINS SUPPLY LEAD DJ	1	EA	1	3	6		1

eikon e4s 230Volts 50Hz - CN - Unique Parts

8	30Z1488	e4s MAINS FILTER	1	EA	1	3	6		1
83	30Z0231	FUSEHOLDER 1in (13A)	3	EA	3	9	18		
84	P30Z1233	230V 50Hz TRANS MULTI 220 240	2	EA	2	6	12		
86	30Z1431	1.2uF 2500V CAPACITOR	2	EA	2	6	12	2	2
87	30Z1425	TRANSFORMER 240V 50/60Hz	1	EA	1	3	6	1	
89	30Z0456	FUSE 1in 13A HRC	3	EA	3	9	18	3	
Not Shown	SR236	e4s MAINS CABLE 1P KE CN	1	EA	1	3	6		1

Merrychef eikon e4s Oven

Recommended Parts List

Recommended Min Stock Holding & Service List

Service Manual Exploded View	Part Number	Description	Qty Per Oven	Unit	1-10 Ovens	11-50 Ovens	51-100 Ovens	Service Centre Kit	e4s Unique Parts over e4
------------------------------	-------------	-------------	--------------	------	------------	-------------	--------------	--------------------	--------------------------

eikon e4s 230Volts 60Hz - KR - Unique Parts

8	30Z1488	e4s MAINS FILTER	1	EA	1	3	6		1
83	30Z0231	FUSEHOLDER 1in (13A)	3	EA	3	9	18		
84	P30Z1230	230V 60Hz TRANS MULTI 220 240	2	EA	2	6	12		
86	30Z1331	1.00uF 2500V CAPACITOR	2	EA	2	6	12	2	2
87	30Z1425	TRANSFORMER 240V 50/60Hz	1	EA	1	3	6	1	
89	30Z0456	FUSE 1in 13A HRC	3	EA	3	9	18	3	
Not Shown	SR234	e4s SINGLE PHASE CABLE	1	EA	1	3	6		1

eikon e4s 220V 60Hz - MX - Unique Parts

8	30Z1488	e4s MAINS FILTER	1	EA	1	3	6		1
83	30Z0285	FUSEHOLDER 1 1/4in (13A)	3	EA	3	9	18		
84	P30Z1230	60HZ TRANS MULTI TAP	2	EA	2	6	12		
86	30Z1331	1.00uF 2500V CAPACITOR	2	EA	2	6	12	2	
87	30Z1455	TRANSFORMER LV CLASS 2	1	EA	1	3	6	1	
89	30Z1507	e4s USA 12A FUSE SLOW/B	3	EA	3	9	18	3	3
Not Shown	SR235	e4s US MAINS LEAD ASSY DF	1	EA	1	3	6		1

eikon e4s 220Volts 60Hz - SA - Unique Parts

8	30Z1488	e4s MAINS FILTER	1	EA	1	3	6		1
83	30Z0231	FUSEHOLDER 1in (13A)	3	EA	3	9	18		
84	P30Z1230	60HZ TRANS MULTI TAP	2	EA	2	6	12		
86	30Z1331	1.00uF 2500V CAPACITOR	2	EA	2	6	12	2	
87	30Z1425	TRANSFORMER 240V 50/60Hz	1	EA	1	3	6	1	
89	30Z0456	FUSE 1in 13A HRC	3	EA	3	9	18	3	
Not Shown		POWER SUPPLY LEAD HE (EU)	1	EA	1	3	6		

eikon e4s 208V & 240V 60Hz - USA - Unique Parts

8	30Z1488	e4s MAINS FILTER	1	EA	1	3	6		1
83	30Z0285	FUSEHOLDER 1 1/4in (13A)	3	EA	3	9	18		
84	P30Z1230	60HZ TRANS MULTI TAP	2	EA	2	6	12		
86	30Z1331	1.00uF 2500V CAPACITOR	2	EA	2	6	12	2	
87	30Z1455	TRANSFORMER LV CLASS 2	1	EA	1	3	6	1	
88	30Z1439	OMRON RELAY 12V	2	EA	2	6	12	2	
89	30Z1507	e4s USA 12A FUSE SLOW/B	3	EA	3	9	18	3	3
Not Shown	SR235	e4s US MAINS LEAD ASSY DF	1	EA	1	3	6		1

eikon e4 Service Kits

Not Shown	PSR110	TEN SPRING SERVICE KIT e3/e4/e4s/e5 & 402s		EA					
Not Shown	PSR113	TWO SPRING SERVICE KIT e3/e4/e4s/e5 & 402s		EA				1	

e4s Accessories

48	DV0714	e4s WIRE RACK	1	EA					
Not Shown	32Z4028	HALF SIZE GASTRONOM DISH	1	EA					
Not Shown	32Z4031	BREAD BASKET (WEAVED)		EA					
Not Shown	32Z4032	HASH-BROWN WEAVE BASKET		EA					
Not Shown	40H0240	ALUMINIUM PTFE TRAY		EA					
Not Shown	DV0343	GRIDDLE CARRIER (FOR PSA1108)		EA					
Not Shown	DV0344	GRIDDLE CARRIER HANDLE (FOR PSA1108)		EA					
Not Shown	DX0117	SQUARE BAKING TRAY	1	EA					
Not Shown	PSA1108	GRIDDLE ACCESSORY PACK		EA					
Not Shown	PSA1248	COOK PLATE KIT - USA		EA					
Not Shown	PSA299	4PACK GRIDDLE PLATES (FOR PSA1108)		EA					
Not Shown	SR310	LARGE PADDLE ALUM ASSY		EA					

NOTES: **NOTE-1** In the event of a broken Hinge Spring, then PSR113 - Two Spring Service Kit or PSR110 - Ten Spring Service Kit are available with tool - NOTE Springs MUST be replaced in Pairs.

Merrychef eikon e5 Oven - Exploded View

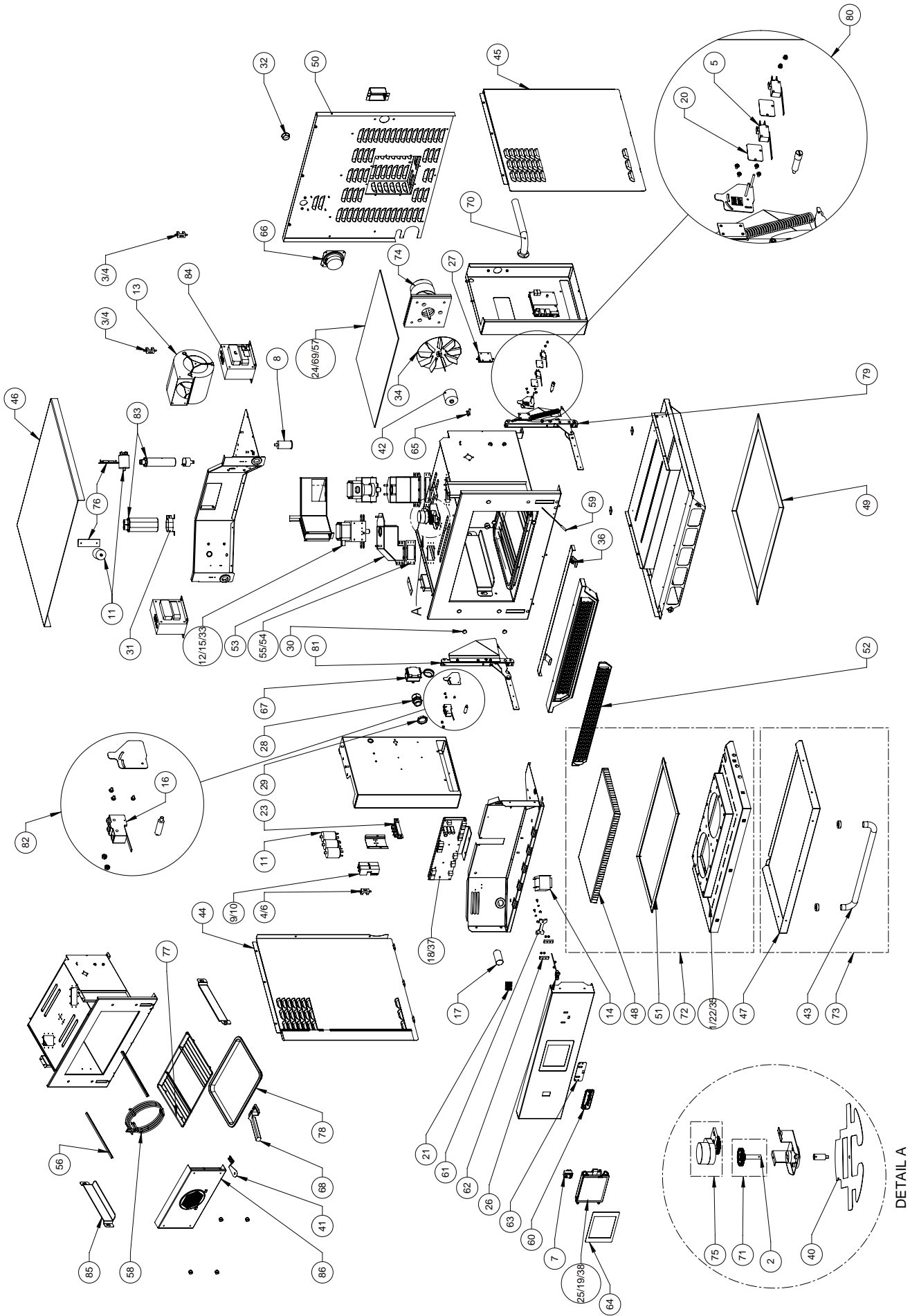

SPARES & REPLACEMENT

DETAIL A

Merrychef eikon e5 Oven

Recommended Parts List

Recommended Min Stock Holding & Service List

Service Manual Exploded View	Part Number	Description	Qty Per Oven	Unit	1-10 Ovens	11-50 Ovens	51-100 Ovens	Recommended Service List
1	31Z4046	M3 CAGE NUT	7	EA	7	21	42	
2	2741021	CERAMIC SHAFT	1	EA	1	3	6	
5	30Z1459	MICROSWITCH	2	EA	2	6	12	2
7	30Z0503	SWITCH ON/OFF ROCKER DPST	1	EA	1	3	6	1
9	30Z1177	20 AMP LITTLEFUZE FLM020	2	EA	2	6	12	2
10	30Z1178	30A FUSE HOLDER	2	EA	2	6	12	
11	30Z1340	FILTER 16A SCREW MOUNT	5	EA	5	15	30	
12	P30Z1415	MAGNETRON 2M303H	2	EA	2	6	12	1
13	30Z1423	500 BLOWER SINGLE FAN (MAGNETRON)	1	EA	1	3	6	
15	30Z1427	MAGNETRON OVERHEAT STAT	2	EA	2	6	12	1
16	30Z1430	MICROSWITCH (LARGE)	1	EA	1	3	6	1
18	P30Z5000	SMART RELAY BOARD SRB	1	EA	1	3	6	1
19	P30Z5009	TOUCH SCREEN PCB	1	EA	1	3	6	1
20	31Z0115	INSULATOR PAD	2	EA	2	6	12	
21	31Z0630	3-WAY TERMINAL BLOCK	1	EA	1	3	6	
22	31Z0186	SILASTIC BLACK (DOOR SEAL)		TUBE	0	0	0	1
23	31Z0477	4 WAY MAINS TERMINAL BLOCK	1	EA	1	3	6	
24	31Z0527	SILASTIC RED (STIRRER GLASS)		TUBE	0	0	0	1
25	31Z0599	BTS UI SRB CABLE (WHITE)	1	EA	1	3	6	
26	31Z0600	USB ADAPTOR MODULE	1	EA	1	3	6	
27	31Z0624	e5 MTR GOLD RESISTOR ASS	1	EA	1	3	6	
28	31Z1255	PG21 CABLE GLAND BLACK	1	EA	1	3	6	
29	31Z1256	PG21 CABLE GLAND NUT	1	EA	1	3	6	
30	31Z1259	SHEET COVER CAP 12MM DIA	6	EA	6	18	36	
31	31Z1261	CAPACITOR CLIP UNIVERSAL	2	EA	2	6	12	
32	31Z1307	ETHERNET HOLE PLUG	1	EA	1	3	6	
33	31Z4016	M5 FLANGE NUT	55	EA	55	165	330	
34	SR314	FAN BLADE	1	EA	1	3	6	
35	31Z7013	ADHESIVE (LOCK 499)		TUBE	0	0	0	
36	31Z7086	REED SWITCH RETAIN CLIP	1	EA	1	3	6	
37	32Z7063	PERSONALITY MODULE SRB e5	1	EA	1	3	6	1
38	32Z7066	PERSONALITY MODULE BTS e5	1	EA	1	3	6	1
40	40C1007	STIRRER BLADE HI DISTRIBUTION	1	EA	1	3	6	
42	40C1217	WAVE TRAP (HOT AIR MOTOR)	1	EA	1	3	6	
43	40C1305	DOOR HANDLE	1	EA	1	3	6	
44	40C1312	SIDE PANEL LH	1	EA	1	3	6	
45	40C1313	SIDE PANEL RH	1	EA	1	3	6	
46	40C1314	TOP PANEL OUTER	1	EA	1	3	6	
47	40C1317	DOOR SKIN	1	EA	1	3	6	
48	40C1340	DOOR CHOKE PLATE	1	EA	1	3	6	
49	40C1344	BASE SEAL 1-PIECE	1	EA	1	3	6	
50	41C0001	BACK PANEL ASSY	1	EA	1	3	6	
51	P41C0003	e5 DOOR SEAL KIT	1	EA	1	3	6	1
52	41C0018	AIR FILTER ASSY	1	EA	1	3	6	1
53	790048	WAVEGUIDE	2	EA	2	6	12	
54	790049	WAVEGUIDE GASKET	2	EA	2	6	12	
55	790050	WAVEGUIDE SEALING PLATE	2	EA	2	6	12	
56	P790052	RED SILICON SEAL LH/RH	1	MT	1	3	6	1
57	P790053	RED SILICON SEAL FRONT/REAR	1	MT	1	3	6	
58	PDR0005	4 COIL HEAT ELEMENT	1	EA	1	3	6	
59	40C1410	e5 REED SWITCH ASSY	1	EA	1	3	6	1
60	DR0007	MERRYCHEF BADGE	1	EA	1	3	6	
61	DR0008	MERRYCHEF BADGE SLIDER	1	EA	1	3	6	
62	DR0009	MERRYCHEF BADGE GUIDE	1	EA	1	3	6	
63	DR0047	MERRYCHEF BADGE SEAL	1	EA	1	3	6	
64	DR0011	TOUCHSCREEN OVERLAY	1	EA	1	3	6	1
65	DR0020	CAVITY TEMP SENSOR (OVEN)	1	EA	1	3	6	1
66	DR0021	HARMONISED SPEAKER	1	EA	1	3	6	
67	DR0042	OVERHEAT STAT SMALL	1	EA	1	3	6	1
69 - 57	P11C0319	STIRRER GLASS ASSY	1	EA	1	3	6	1
70	P11C0498	STEAM PIPE WRAPPED ASSY	1	EA	1	3	6	
71	P11C0537	THV2 STIRRER GEAR & SHAFT	1	EA	1	3	6	
72	P11C0578	DOOR FRAME ASSY HARM	1	EA	1	3	6	

Merrychef eikon e5 Oven

Recommended Parts List

Recommended Min Stock Holding & Service List

Service Manual Exploded View	Part Number	Description	Qty Per Oven	Unit	1-10 Ovens	11-50 Ovens	51-100 Ovens	Recommended Service List
73	P11C0579	DOOR OUTER COVER ASSY	1	EA	1	3	6	
75	P11C0593	STIRRER MOTOR ASSY	1	EA	1	3	6	
79 - 81	PSR101	EIKON DOOR HINGE KIT (NOTE-1 BELOW)		EA	0	0	0	
76	PSR109	DIODE REPLACEMENT KIT	2	EA	2	6	12	2
80 - 82	PSR102	EIKON M/SWITCH BRACKET KIT		EA	0	0	0	
Not Shown	30Z1457	EIKON SRB 1.25A FUSE	1	EA	1	3	6	1
Not Shown	40C1394	STEAM VENT CAP	1	EA	1	3	6	
Not Shown	41C0005	500 LOWER TRIM ASSY	1	EA	1	3	6	
Not Shown	DR0045	SPEAKER WIRE	1	EA	1	3	6	
Not Numbered	DX0146	SCREW CAT COVER	4	EA	4	12	24	

eikon e5 - 230V 50Hz UK/EU CAT - Unique Parts

3	30Z0217	FUSE 1in 10A HRC	2	EA	2	6	12	2
4	30Z0231	FUSEHOLDER 1in (13A)	3	EA	3	9	18	
6	30Z1207	FUSE 1in 3A HBC	1	EA	1	3	6	1
8	30Z1148	MOTOR START CAP 6uF	1	EA	1	3	6	
14	30Z1425	LV TRANSFORMER	1	EA	1	3	6	1
17	30Z1437	2.5uF STARTER CAP - MOTOR START	1	EA	1	3	6	
74	P11C0606	HOT AIR MOTOR SERVICE KIT EU	1	EA	1	3	6	
83	30Z1330	0.88uF 2500V CAPACITOR	2	EA	2	6	12	2
84	P30Z1413	230V 50Hz TRANSFORMER	2	EA	2	6	12	
85	40C0864	SHELF SUPPORT CTM3 EUROPE	2	EA	2	6	12	
Not Shown	P11C0595	e5 CAT CONVERTOR ASSY	1	EA	1	3	6	
Not Shown	SR206	POWER SUPPLY LEAD GC 3P (EU)	1	EA	1	3	6	

eikon e5 - 230V 50Hz UK/EU - Unique Parts

3	30Z0217	FUSE 1in 10A HRC	2	EA	2	6	12	2
4	30Z0231	FUSEHOLDER 1in (13A)	3	EA	3	9	18	
6	30Z1207	FUSE 1in 3A HBC	1	EA	1	3	6	1
8	30Z1148	MOTOR START CAP 6uF	1	EA	1	3	6	
14	30Z1425	LV TRANSFORMER	1	EA	1	3	6	1
17	30Z1437	2.5uF STARTER CAP - MOTOR START	1	EA	1	3	6	
74	P11C0606	HOT AIR MOTOR SERVICE KIT EU	1	EA	1	3	6	
83	30Z1330	0.88uF 2500V CAPACITOR	2	EA	2	6	12	2
84	P30Z1413	230V 50Hz TRANSFORMER	2	EA	2	6	12	
85	40C0864	SHELF SUPPORT CTM3 EUROPE	2	EA	2	6	12	
86	790047	ELEMENT COVER PLATE (NON CAT)	1	EA	1	3	6	
Not Shown	SR206	POWER SUPPLY LEAD GC 3P (EU)	1	EA	1	3	6	

eikon e5 - 230V 50Hz UK/EU - Unique Parts

3	30Z0217	FUSE 1in 10A HRC	2	EA	2	6	12	2
4	30Z0231	FUSEHOLDER 1in (13A)	3	EA	3	9	18	
6	30Z1207	FUSE 1in 3A HBC	1	EA	1	3	6	1
8	30Z1148	MOTOR START CAP 6uF	1	EA	1	3	6	
14	30Z1425	LV TRANSFORMER	1	EA	1	3	6	1
17	30Z1437	2.5uF STARTER CAP - MOTOR START	1	EA	1	3	6	
74	P11C0606	HOT AIR MOTOR SERVICE KIT EU	1	EA	1	3	6	
83	30Z1330	0.88uF 2500V CAPACITOR	2	EA	2	6	12	2
84	P30Z1413	230V 50Hz TRANSFORMER	2	EA	2	6	12	
85	40C0864	SHELF SUPPORT CTM3 EUROPE	2	EA	2	6	12	
86	790047	ELEMENT COVER PLATE (NON CAT)	1	EA	1	3	6	
Not Shown	SR210	POWER SUPPLY LEAD HE 1P (EU)	1	EA	1	3	6	

Merrychef eikon e5 Oven

Recommended Parts List

Recommended Min Stock Holding & Service List

Service Manual Exploded View	Part Number	Description	Qty Per Oven	Unit	1-10 Ovens	11-50 Ovens	51-100 Ovens	Recommended Service List	
eikon e5 - 208V & 240V 60Hz USA CAT - Unique Parts									
	4	30Z0285	FUSEHOLDER 1 1/4in	3	EA	3	9	18	3
	3	30Z1445	FUSE 10A UL	2	EA	2	6	12	2
	6	30Z1443	FUSE 3A UL	1	EA	1	3	6	1
	8	30Z1448	STARTER CAP 6uF UL (MOTOR START)	1	EA	1	3	6	
	14	30Z1455	TRANSFORMER LV CLASS 2	1	EA	1	3	6	1
	17	30Z1447	STARTER CAP 2.5uF UL	1	EA	1	3	6	
	74	P11C0607	HOT AIR MOTOR SERVICE KIT US	1	EA	1	3	6	
	83	30Z1330	0.88uF 2500V CAPACITOR	2	EA	2	6	12	2
	84	P30Z1230	60HZ TRANS MULTI TAP	2	EA	2	6	12	
	85	40C1230	SHELF RUNNER - SINGLE	2	EA	2	6	12	
Not Shown		30Z1439	RELAY 12V OMRON	2	EA	2	6	12	2
Not Shown		31Z1266	PLUG & LEAD ASSY (SUBWAY)	1	EA	1	3	6	
Not Shown		DX0104	MAINS SUPPLY LEAD D (US)	1	EA	1	3	6	
Not Shown		P11C0493	EC503 REMOVABLE CATALYST	1	EA	1	3	6	

eikon e5 Upgrade Kits - All Models

Not Shown	P10C0343	e5 STUD REPAIR KIT (x1 STUD ONLY)		EA					
Not Shown	PSR110	TEN SPRING SERVICE KIT e3/e4/e4s/e5 & 402s		EA					
Not Shown	PSR113	TWO SPRING SERVICE KIT e3/e4/e4s/e5 & 402s		EA					1

e5 Accessories

	41	40C1083	CLEANING SCOOP		EA				
	68	SR313	GENERIC HANDLE V2		EA				
	77	DR0057	CHROMIUM PLATED STEEL RACK		EA				
	78	P40C1423	VITROUS ENAMEL TRAY		EA				
	Not Shown	40C1218	TEFLON LINER		EA				

NOTES: **NOTE-1** In the event of a broken Hinge Spring, then PSR113 - Two Spring Service Kit or PSR110 - Ten Spring Service Kit are available with tool - NOTE Springs MUST be replaced in Pairs.

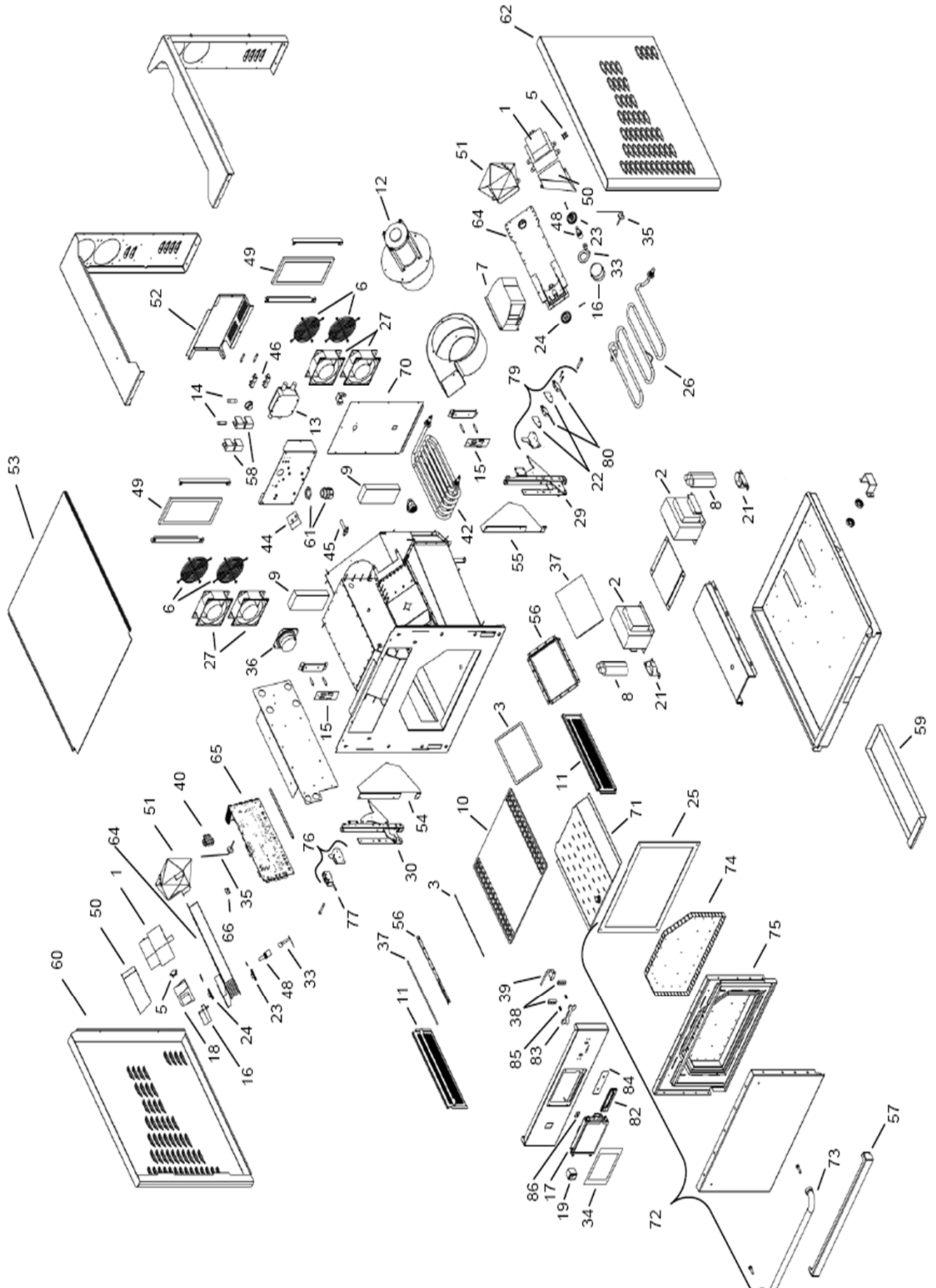

Merrychef eikon e6 Oven

Recommended Parts List

Recommended Min Stock Holding & Service List

Service Manual Exploded View	Part Number	Description	Qty Per Oven	Unit	1-10 Ovens	11-50 Ovens	51-100 Ovens	Recommended Service List
1	P30Z1472	MAGNETRON	2	EA	2	6	12	1
2	P30Z1509	e2 TRANS 208-230V 60Hz	2	EA	2	6	12	
3-37	PSJ161	e2/e6 PARTITION PLATE KIT	1	EA	1	3	6	1
5	30Z1480	e2/e6 MAG HI LIMIT STAT	2	EA	2	6	12	1
6	31Z1322	FAN GUARD LRG	4	EA	4	12	24	
7	30Z1512	e6 SPEED CONTROLLER	1	EA	1	3	6	
8	30Z1330	0.88uF 2500V CAPACITOR	2	EA	2	6	12	2
9	DG0029	CATALYST 6.4x2.5x1.0	2	EA	2	6	12	
11	SG335	e6 GREASE FILTER SHELF	2	EA	2	6	12	
12	PSG225	e6 CONVECTION MOTOR ASSY	1	EA	1	3	6	
13	30Z1514	RFI FILTER e6	1	EA	1	3	6	
14	30Z1515	FUSE MAIN CIRCUIT e6	2	EA	2	6	12	2
15	PSR109	DIODE REPLACEMENT KIT	2	EA	2	6	12	2
16	PSA288	STIRRER MOTOR ASSY	2	EA	2	6	12	
17	P30Z5009	TOUCH SCREEN PCB	1	EA	1	3	6	1
18	30Z1455	TRANSFORMER LV CLASS 2	1	EA	1	3	6	1
19	30Z0503	SWITCH ON/OFF ROCKER DPST	1	EA	1	3	6	1
21	31Z1261	CAPACITOR CLIP UNIVERSAL	2	EA	2	6	12	
22	31Z0115	INSULATOR PAD	2	EA	2	6	12	
23	DV0325	GEAR WHEEL - PINNED MOTOR	2	EA	2	6	12	
24	DV0552	GEAR - STIRRER	2	EA	2	6	12	
25	PSG333	e6 DOOR GASKET	1	EA	1	3	6	1
26	DG0144	HEATING ELEM-RAD WATLOW	1	EA	1	3	6	
27	30Z1475	CABINET FAN e2 LRG	4	EA	4	12	24	
29-30-54-55-76-79	PSG126	e6 DOOR HINGE KIT	1	EA	1	3	6	1
33-48	PSG204	e6 STIRRER ASSY	2	EA	2	6	12	
34	DR0011	TOUCHSCREEN OVERLAY	1	EA	1	3	6	1
35	PSJ243	DUAL THERMOCOUPLE ASSY e2/e6	1	EA	1	3	6	1
36	DR0021	HARMONISED SPEAKER	1	EA	1	3	6	
38	DR0009	MERRYCHEF BADGE GUIDE	2	EA	2	6	12	
39	31Z0600	ADAPTOR USB / LEAD	1	EA	1	3	6	
40	31Z0661	e2 USA 2-WAY TERM BLOCK	1	EA	1	3	6	
42	DG0143	TOP HEATER RADIANT OVEN	1	EA	1	3	6	
44	30Z1474	e2 THERMAL TRIP	1	EA	1	3	6	1
45	SG339	STEAM PIPE ASSY	1	EA	1	3	6	
46	30Z1504	e2 USA FUSE HOLDER	2	EA	2	6	12	
49	31Z1362	AIR FILTER	2	EA	2	6	12	2
50	DG0172	e6 MAG EXHAUST SHROUD	2	EA	2	6	12	
51	DG0173	e6 MAG INLET SHROUD	2	EA	2	6	12	
52	DG0182	e6 FUSE BOX COVER	1	EA	1	3	6	
53	DG0059	e6 TOP PANEL	1	EA	1	3	6	
56	DG0204	e6 PARTITION PLATE BRKT	2	EA	2	6	12	
57	DG0214	e6 UNDER DOOR COVER	1	EA	1	3	6	
58	30Z1505	e2 USA LARGE FUSE HOLDER	2	EA	2	6	12	
59	DG0183	e6 GREASE TRAY LONG	1	EA	1	3	6	
60	DG0061	e6 SIDE PANEL LH	1	EA	1	3	6	
61	31Z1331	e2 US GLAND + NUT	1	EA	1	3	6	
62	DG0060	e6 SIDE PANEL RH	1	EA	1	3	6	
64	SG330	WAVEGUIDE ASSY e6	2	EA	2	6	12	
65	30Z5017	e6 SRB BOARD	1	EA	1	3	6	1
66	32Z7071	e6 SRB PERSONALITY MOD	1	EA	1	3	6	1
70	SG336	e6 BACK ACCESS PANEL ASSY	1	EA	1	3	6	
71	SG343	e6 JET PLATE ASSY	1	EA	1	3	6	
72	PSG105	e6 DOOR ASSY (COMPLETE)	1	EA	1	3	6	
73	DV0431	DOOR HANDLE	1	EA	1	3	6	
74	DG0227	e6 DOOR CHOKE FINISHED	1	EA	1	3	6	
75-74-25	PSG301	e6 DOOR INNER ASSY		EA	0	0	0	
76 & 79	PSR102	EIKON M/SWITCH SERV KIT	1	EA	1	3	6	
77	30Z1430	MICROSWITCH (LARGE)	1	EA	1	3	6	1
80	30Z1459	MICROSWITCH HONEYWELL	2	EA	2	6	12	2
82	DR0007	MERRYCHEF BADGE	1	EA	1	3	6	
83	DR0008	MERRYCHEF BADGE SLIDER	1	EA	1	3	6	
84	DR0047	MERRYCHEF BADGE SEAL	1	EA	1	3	6	
85	31Z1302	BADGE RETAINING SPRING	2	EA	2	6	12	
86	32Z7074	e6 QTS PERSONALITY MOD	1	EA	1	3	6	1
Not Shown	31Z4046	M3 CAGE NUT	8	EA	8	24	48	

Merrychef eikon e6 Oven

Recommended Parts List

Recommended Min Stock Holding & Service List

Service Manual Exploded View	Part Number	Description	Qty Per Oven	Unit	1-10 Ovens	11-50 Ovens	51-100 Ovens	Recommended Service List
Not Shown	30Z1517	FUSE BK/MDA-20-R T-LAG	2	EA	2	6	12	2
Not Shown	31Z0186	SILASTIC BLACK (DOOR SEAL)		TUBE	0	0	0	1
Not Shown	31Z0527	SILASTIC RED		TUBE	0	0	0	1
Not Shown	31Z0599	BTS UI SRB CABLE (WHITE)	1	EA	1	3	6	
Not Shown	31Z1252	BOLT M4 X 10 HEX HD (PARTITION PLATE)	18	EA	18	54	108	
Not Shown	31Z1320	e2/e6 DOOR SWITCH SPACER	3	EA	3	9	18	
Not Shown	31Z1328	PLUG 1/2 INCH RND KICKEL	4	EA	4	12	24	
Not Shown	31Z1335	EIKON USB MENUKEY	1	EA	1	3	6	
Not Shown	31Z1364	STEAM TUBE 1/2" NPT	1	EA	1	3	6	
Not Shown	DG0009	HORN QUARTZ e6	2	EA	2	6	12	
Not Shown	DG0028	e6 BASE SEAL	1	EA	1	3	6	
Not Numbered	DG0058	e6 CONTROL PANEL	1	EA	1	3	6	
Not Shown	DG0175	e6 STEAM PIPE	1	EA	1	3	6	
Not Numbered	DG0220	DOOR SKIN FINISHED	1	EA	1	3	6	
Not Shown	DR0030	HANDLE SPACER	2	EA	2	6	12	
Not Numbered	DV0370	LOWER IMPINGER HANDLE	1	EA	1	3	6	
Not Numbered	PSG214	e6 DOOR SKIN ASSY		EA	0	0	0	
Not Numbered	SG303	e6 CAVITY ASSY	1	EA	1	3	6	
Not Shown	SG337	e6 DOOR INSULATION KIT	1	EA	1	3	6	
Not Shown	SG338	e6 CAVITY INSULATION KIT	1	EA	1	3	6	

eikon e6 208/240Volts 60Hz - USA (DF) - Unique Parts

Not Shown	DJ0140	e2P MAINS LEAD DF (30A)	1	EA	1	3	6	
-----------	--------	-------------------------	---	----	---	---	---	--

eikon e6 208/240Volts 60Hz - USA (DH) - Unique Parts

Not Shown	DG0069	e6 MAINS LEAD DH (30A)	1	EA	1	3	6	
-----------	--------	------------------------	---	----	---	---	---	--

e6 Accessories

10	32Z4052	COOK PLATE e6	1	EA	1	3	6	
Not Shown	32Z4028	HALF SIZE GASTRONORM DISH	1	EA	1	3	6	
Not Shown	32Z4055	e6 SOLID BASKET	2	EA	2	6	12	
Not Shown	SR310	LARGE PADDLE ALUM ASSY	1	EA	1	3	6	