



Catalogo Generale Prodotti a Legna

IL RISCALDAMENTO A LEGNA
WOOD HEATING
LE CHAUFFAGE À BOIS
DIE HOLZHEIZUNG
LA CALEFACCIÓN A LEÑA

Main Catalogue Wood Products



Catalogo Generale



Stufe

Stoves - Poêles - Öfen - Estufas

Cucine

Ranges - Cuisinières - Herde - Cocinas

TermoProdotti

Thermo products - Appareils de chauffage
Thermoprodukte - Productos térmicos

Accessori

Optional Accessories - Accessoires Optionnel
Zubehör auf Anfrage - Accesorios Optional





SOMMARIO



ATTENZIONE

Gentile Cliente,
tutti i rivenditori La NORDICA-EXTRAFLAME sono al suo servizio per fornirle qualsiasi consiglio ed informazione tecnica indispensabile a scegliere la cucina o stufa a legna che potrà soddisfare le sue esigenze. Prima dell'acquisto richieda sempre al suo rivenditore di fiducia La NORDICA-EXTRAFLAME di poter consultare il LIBRETTO D'ISTRUZIONI, inserito in tutti i prodotti dove sono illustrati tutti i dati relativi alla corretta installazione e successivo utilizzo dei nostri prodotti.
Grazie per averci preferito.

ATTENTION

Dear customer,
All La NORDICA EXTRAFLAME dealers are at your service to provide the advice and technical information you need to choose a wood burning range or stove to satisfy your needs. Before making your purchase, always ask your local La NORDICA EXTRAFLAME dealer to let you consult the INSTRUCTIONS included in all products giving complete information on correct installation and use of our products.
Thank you for choosing our company.

ATTENTION

Cher client,
Les revendeurs La NORDICA-EXTRAFLAME sont à votre service pour vous fournir tous les conseils et informations techniques indispensables pour choisir la cuisinière ou le poêle à bois qui pourra répondre à vos besoins. Avant l'achat demandez à votre revendeur La NORDICA-EXTRAFLAME de consulter la NOTICE D'INSTRUCTIONS, qui donne toutes les informations utiles pour une bonne installation et utilisation de nos produits.
Merci de nous avoir choisi.

ACHTUNG

Sehr geehrter Kunde,
alle La NORDICA-EXTRAFLAME-Fachhändler stehen mit Ratschlägen und technischen Informationen zu Ihrer Verfügung, um Ihnen dabei zu helfen, den Herd oder Ofen auszusuchen, der Ihren Ansprüchen am besten gerecht wird. Bitten Sie vor dem Kauf Ihren La - Fachhändler immer, die GE-BRAUCHSANWEISUNGEN einsehen zu können, die allen Modellen beiliegen, wo alle entsprechenden Daten für eine korrekte Installation und den nachfolgenden Gebrauch unserer Produkte aufgeführt sind. Wir danken Ihnen für das entgegengebrachte Vertrauen.

ATENCIÓN

Estimado Cliente,
todos los revendedores de La NORDICA-EXTRAFLAME están a su servicio para ofrecer cualquier consejo y la información técnica indispensable para elegir la cocina o la estufa a leña que satisfaga sus exigencias. Antes de comprar solicite siempre a su revendedor de confianza de La NORDICA-EXTRAFLAME la posibilidad de consultar el MANUAL DE INSTRUCCIONES, incluido en todos los productos, donde se ilustran todos los datos relativos a la instalación correcta y posterior uso de nuestros productos.
Gracias por habernos elegido.

Company profile	4	Serie Carillon	92	Serie Rossella	156	Rosetta Maiolica.....	216
		Fortuna.....	94	Rossella R1	158	Rosetta	218
STUFE		Fortuna Panorama	96	Rossella Plus Liberty	160	Sovrana Evo.....	220
Serie Combinata	42	Ellipse.....	98	Rossella Plus.....	162	Sovrana Easy	222
Cleo Combi Vogue.....	44	Fireball.....	100	Rossella Plus Forno Evo.....	164	Romantica	224
		Carillon 16:9 Evo.....	102				
Serie Top Maiolica	46	Serie in Ghisa	104	Serie Fulvia, Dorella e Gemma	166	TERMOPRODOTTI	
Venere Silk Vogue Ametista.....	48	Giulietta X	106	Fulvia	168	Serie TermoProdotti	226
Anthea Verticale	50	Isetta con Cerchi Evo.....	108	Fulvia Forno	170	TermoRossella Plus Evo D.S.A.	228
		Isetta Evo	110	Dorella L8 X.....	172	TermoRossella Plus Forno D.S.A.	230
Serie Slim	52	Isotta con Cerchi Evo.....	112	Gemma	174	TermoNicoletta D.S.A.	232
Plasma 80:26	54	Isotta Evo	114	Gemma Forno.....	176	TermoNicoletta Forno D.S.A.	234
Doris.....	56	Isotta Forno.....	116			Loriet S D.S.A.....	236
Doris Silk Vogue Ametista.....	58	Candy.....	118	Serie Bruciatutto	178	Termolsotta D.S.A.	238
		Viola	120	Super Max & Super Junior	180	Norma S Idro D.S.A.	240
Serie Stufe-Camino	60	Violetta.....	122	Major, Max & Junior	182	Norma S Evo Idro D.S.A.	242
Fly Sospeso	62			Mignon	184	Norma Classic S Evo Idro D.S.A.	244
Fly con supporto	64	Serie Armony	124			Norma Steel S Evo Idro D.S.A.	246
Falò 1C.....	66	Stefany Forno.....	126	CUCINE		Fly Idro D.S.A.	248
Falò 1XL	68	Svezia New e Norvegia New	128	Serie Cucine a Legna	186	TermoCucinotta Evo D.S.A.	250
Falò 2L	70	Luna	130	America	188	TermoSovrana D.S.A.	252
Falò 2S.....	72	Lucy	132	Suprema.....	190	TermoRosa D.S.A.	254
		Nicoletta	134	Mamy	192	TermoRosa Ready D.S.A. 2.0	256
Serie Top Design	74	Nicoletta Forno Evo	136	Italy.....	194	Termorosa XXL D.S.A.....	258
Astrid.....	76	Gaia.....	138	Cucinotta	196	Termorosa XXL Ready D.S.A 2.0	260
Fiò.....	78	Gaia Forno	140	Italy Built-in.....	198	TermoSuprema Compact D.S.A.	262
Wanda.....	80	Fiammetta	142	Vicenza.....	News 200	Italy Termo Built-in D.S.A.	264
Wanda Classic	82	Gisella.....	144	Verona	News 202	Italy Termo D.S.A.	266
Fortuna Bifacciale.....	84	Fiorella.....	146	Padova	News 204	Modulo All Inclusive Italy Termo D.S.A. 2.0...268	
Fortuna Steel	News 86	Asia.....	148	Rosa XXL	206	Modulo All Inclusive Uni. D.S.A. 2.0.....270	
Helga.....	News 88	Ester.....	150	Rosa Reverse.....	208		
Zen.....	90	Ester Forno Evo.....	152	Rosa Liberty.....	210	ACCESSORI	272
		Giorgia.....	154	Rosa Maiolica	212	LEGENDA	278
				Rosa	214		

La Storia

History / L'Histoire / Geschichte / La Historia

Dal 1967 la passione ed il duro lavoro del nord-est si rispecchiano nella famiglia Dal Zotto ed in quello che nel tempo è divenuto oggi il Gruppo La Nordica-Extrafame, azienda vicentina in costante espansione nazionale ed internazionale, con all'attivo una gamma di oltre 200 prodotti hi-tech per la produzione di energia per il riscaldamento domestico, rigorosamente a legna e pellet.

Sono stufe, cucine, caminetti e caldaie, anche collegabili con i radiatori di casa, diventando così dei veri impianti di riscaldamento. Una innovazione della quale beneficiano i consumatori, per i sensibili risparmi economici su costi dell'energia.

Il sistema industriale La Nordica-Extrafame, è stato recentemente completato da una nuova divisione, dedicata allo sviluppo della tecnologia solare attraverso i Pannelli termici, che permette di produrre il fabbisogno energetico di acqua calda sanitaria, in alternativa al tradizionale gas o gasolio.

Una storia di qualità e incessante innovazione, attestata dalle più aggiornate certificazioni internazionali, pone le proposte del Gruppo all'avanguardia nel settore.



Depuis 1967 la passion et le travail sont les valeurs qui animent la famille Dal Zotto, et ce qui au cours des années est devenu le Groupe La Nordica-Extrafame, entreprise de la région de Vicence qui poursuit son expansion nationale et internationale, avec une gamme de plus de 200 appareils hi-tech pour la production d'énergie pour le chauffage domestique, uniquement à bois et granulés (pellets).

Ce sont des poêles, cuisinières, cheminées et chaudières, qui peuvent être raccordés à des radiateurs pour réaliser une véritable installation de chauffage. Une innovation dont bénéficient à la fois les consommateurs, qui peuvent réaliser des économies

d'énergie importantes, et l'environnement parce que le bois est une énergie renouvelable.

Le système industriel La Nordica-Extrafame a été récemment complété par un nouveau département dédié au développement de panneaux solaires, technologie qui permet de produire l'énergie nécessaire à l'eau chaude sanitaire à la place du gaz ou fuel.

Une histoire de qualité et d'innovation constante, attestée par les certifications européennes les plus importantes, qui place les produits du Groupe parmi les meilleurs du marché.

Since 1967, the passion and hard work of north-east Italy has been reflected in the Dal Zotto family and in what over time has become the La Nordica-Extrafame Group, a Vicenza based company constantly expanding both in Italy and internationally, offering a range of more than 200 high-tech wood and pellet fired products generating energy for home heating.

These include stoves, ranges, fireplaces and boilers which can also be connected to radiators to become genuine heating installations. An innovation benefiting consumers with significant savings on energy costs and the environment because wood is a renewable energy source.

The La Nordica-Extrafame industrial system has recently been completed with the addition of a new division dedicated to the development of solar panels, a technology enabling domestic hot water to be produced using an energy other than traditional gas or diesel.

A story of quality and constant innovation, confirmed by the most important European certificates, places the Group's products at the top of the market.



1970



2015

Seit 1967 steht die Familie Dal Zotto für die Leidenschaft und harte Arbeit, die den Nordosten Italiens prägen. Aus dem Familienunternehmen wurde im Lauf der Jahre der heutige Konzern La Nordica-Extrafame, ein Unternehmen aus Vicenza, das sich durch stetige Expansion auf nationaler und internationaler Ebene auszeichnet und mit einem Angebot an über 200 Hightech-Produkten für die Erzeugung von Heizenergie für den Privatbereich, ausschließlich mit Holz und Pellets, aufwartet.

Dabei handelt es sich um Öfen, Herde, Kaminöfen und Heizkessel, die auch an die Heizkörper der Wohnung angeschlossen werden können und so zu richtigen Heizungsanlagen werden. Eine Innovation, von der die

Verbraucher aufgrund der erheblichen Einsparung an Energiekosten sowie die Umwelt profitieren, denn Holz ist eine erneuerbare Energiequelle.

Das Industriesystem La Nordica-Extrafame wurde erst kürzlich durch ein neues Geschäftsfeld ergänzt, das sich mit der Entwicklung von Solarpaneelen beschäftigt, einer Technologie, die die Erzeugung des Energiebedarfs an Warmwasser als Alternative zur herkömmlichen Erzeugung durch Gas oder Diesel ermöglicht.

Die wichtigsten europäischen Zertifizierungen bestätigen die Qualität und unaufhörliche Innovation des Unternehmens, was dafür sorgt, dass die Produkte des Konzerns ganz oben im Markt mitspielen.

Desde 1967 la pasión y el trabajo duro del nordeste italiano se reflejan en la familia Dal Zotto y en el que, con el tiempo, hoy se ha convertido en el Grupo La Nordica-Extrafame, empresa de Vicenza en constante expansión nacional e internacional con, en el activo, una gama de más de 200 productos de alta tecnología para la producción de energía para la calefacción doméstica, rigurosamente con leña y pellet.

Son estufas, cocinas, chimeneas y calderas que también pueden conectarse a los radiadores de casa, convirtiéndose así en verdaderas instalaciones de calefacción.

Una innovación de la que gozan los consumidores, por el importante ahorro sobre el coste de la energía y en el medio ambiente al ser la madera una fuente de energía renovable.

El sistema industrial La Nordica-Extrafame, se ha completado recientemente con una nueva división, dedicada al desarrollo de los Paneles Solares, tecnología que permite producir la necesidad energética de agua caliente sanitaria, en alternativa a los tradicionales gas o gasóleo.

Una historia incesante de calidad e innovación, refrendada por las certificaciones europeas más importantes, que sitúa a las propuestas del Grupo en la cúspide del mercado.



Il Gruppo

The Group / Le Groupe / Geschichte / El Grupo



Stabilimento La Nordica
Montecchio Precalcino



Training Center La Nordica-Extrablame
Montecchio Precalcino

Stabilimento di Breganze



Stabilimento di Fara Vicentino



Numeri ma non solo:
il Gruppo La Nordica-Extrablame ha raggiunto una prestigiosa posizione internazionale grazie a 5 stabilimenti produttivi e di stoccaggio materiale, per un totale di circa 70.000 m² dislocati nel territorio vicentino, nei quali la produzione rigorosamente Made in Italy si affida alla continua ricerca tecnica per il miglioramento e la creazione di nuove ed efficaci proposte, che attraverso la rete commerciale possono fornire in oltre 40 paesi esteri. Inoltre nel Training Center, dotato di 6 aule tematiche, tecnici e incaricati alla vendita sono sottoposti a una formazione costante, per risolvere tutte le necessità dell'utente finale.



Stabilimento Extrablame
Montecchio Precalcino

Des chiffres mais pas seulement:
le Groupe La Nordica-Extrablame occupe une position internationale majeure grâce à ses 5 usines de production et de stockage, pour une superficie totale de 70.000 m² environ, situées dans la province de Vicence, où la production, rigoureusement Made in Italy, s'appuie sur une recherche technique continue pour l'amélioration et la création de nouveaux appareils efficaces, vendus dans plus de 40 pays à travers le réseau commercial. En outre le Training Center, équipé de 6 salles thématiques, permet de fournir aux techniciens et vendeurs une formation continue, afin de répondre à tous les besoins de l'utilisateur final.

Nicht nur Zahlen:

Zu verdanken hat der Konzern La Nordica-Extrablame seine namhafte internationale Positionierung den 5 auf dem Gebiet der Provinz Vicenza verteilten Werken für die Herstellung und Materiallagerung mit einer Gesamtfläche von zirka 70.000 qm. Hier - ausschließlich in Italien - erfolgt die Produktion, die auf der ständigen technischen Weiterentwicklung basiert, um Produkte zu verbessern sowie neue, effiziente Lösungen zu bieten, die mittels des Vertriebsnetzes in über 40 Länder geliefert werden können. Im mit sechs Themenräumen ausgestatteten Trainingcenter werden zudem Techniker und sonstige Mitarbeiter/Vertreter geschult, um allen Bedürfnissen des Endverbrauchers gerecht werden zu können.

More than just statistics...

the La Nordica-Extrablame Group has reached a prestigious international position thanks to its five production plants and storage sites covering a total of about 70,000 m² throughout the Vicenza area where a strictly Made-in-Italy production process is backed by constant technical research to improve and create new efficient products for supply in more than 40 countries through the company's sales network.

In addition, technical and sales staff attend constant training and refresher courses in the Training Center with its six themed rooms, enabling them to satisfy all the end user's needs.

Números pero no sólo:

el Grupo La Nordica-Extrablame ha alcanzado una prestigiosa posición internacional gracias a 5 centros de fabricación y de almacenaje de material, con un total aproximado de 70.000 m² repartidos por el territorio de Vicenza, en los que la producción rigurosamente "Made in Italy" se confía a la continua investigación técnica para la mejora y la creación de nuevas y eficaces propuestas, que a través de la red comercial pueden suministrar a más de 40 países extranjeros.

Además en el Centro de Formación, provisto de 6 aulas temáticas, los técnicos y el personal de ventas reciben una formación constante, para resolver todas las necesidades del usuario final.

Design

La cura, la fantasia, la precisione del design tipica della cultura industriale italiana sposa la filosofia del risparmio e del rispetto ambientale.

Nascono così prodotti all'avanguardia costruiti esclusivamente in Italia e riconosciuti a livello internazionale per la loro grande qualità estetica e funzionale.

L'eccellenza del made in Italy, si riflette in particolare in ogni serie dei prodotti La Nordica-Extraflame dove ergonomia, rigore formale, cura dei dettagli, fantasia e impatto ambientale zero, diventano priorità e prerogative indissolubili.



The care, imagination and design precision typical of the Italian industrial culture are combined with a philosophy of saving and respect for the environment.

The result is modern products made exclusively in Italy and recognised internationally for their high aesthetic and functional quality.

Made-in-Italy excellence is reflected in all lines of La Nordica-Extraflame products, where ergonomics, meticulous attention to style and detail, imagination and zero environmental impact become essential priorities and prerogatives.

Le soin, la fantaisie, la précision du design, typique de la culture industrielle italienne, se conjuguent avec l'économie et le respect de l'environnement.

Cela donne naissance à des appareils modernes, entièrement construits en Italie et appréciés au niveau international pour leur grande qualité esthétique et fonctionnelle.

L'excellence du Made in Italy se reflète en particulier dans chaque série des appareils La Nordica-Extraflame où ergonomie, rigueur formelle, soin des détails, fantaisie et impact environnemental zéro, deviennent des priorités et des exigences incontournables.



Die für die italienische Industriekultur typische Sorgfalt, Phantasie und Präzision stehen im Einklang mit der Philosophie der Einsparung und des Umweltschutzes.

So entstehen moderne Produkte, die ausschließlich in Italien entwickelt werden, und aufgrund ihrer hohen Qualität, was Optik und Funktion betrifft, auf internationaler Ebene Anerkennung finden.

Die Exzellenz made in Italy kommt in jeder La-Nordica-Extraflame-Produktreihe zum Ausdruck: Ergonomie, schlichte Formen, Liebe zum Detail, Phantasie und das Vermeiden von Umweltbelastungen haben absolute Priorität und sind unverzichtbare Voraussetzungen.

El cuidado, la fantasía, la precisión del diseño típicos de la cultura industrial italiana se unen a la filosofía del ahorro y del respeto por el medio ambiente.

Nacen así unos productos modernos, fabricados exclusivamente en Italia y reconocidos a nivel internacional por su gran calidad estética y funcional.

La excelencia del "made in Italy", se refleja especialmente en cada serie de los productos La Nordica-Extraflame en los que ergonomía, rigor formal, cuidado de los detalles, fantasía e impacto medioambiental cero, se convierten en una prioridad y una prerrogativa indisolubles.



Tecnologia

Technology / Technologie / Technologie / Tecnología

I prodotti La Nordica-Extraflame rappresentano le più moderne e ricercate soluzioni per il riscaldamento domestico.

Progettati, costruiti e testati esclusivamente in Italia, grazie ad accurate ricerche sul fronte costruttivo ed ecologico sono in grado di assicurare basse emissioni e minimo inquinamento nonché la miglior resa e un grande risparmio economico.

Innovazioni per una perfetta combustione della legna o del pellet, la possibilità di collegamento tra termostati e radiatori di casa, l'elettronica evoluta nei prodotti a pellet anche per effettuare controlli da remoto e gestire la potenza ottimale rispetto all'impianto termico esistente, sono solo alcuni esempi del continuo e costante sviluppo per puntare alle migliori performance.



Les appareils La Nordica-Extraflame représentent les solutions les plus modernes et les plus sophistiquées pour le chauffage domestique.

Conçus, fabriqués et testés exclusivement en Italie, grâce à des recherches constantes en matière de fabrication et de respect de l'environnement, ils offrent le meilleur rendement avec de faibles émissions polluantes, et permettent de réaliser des économies.

Des innovations pour une parfaite combustion du bois ou des granulés, la possibilité de raccorder les appareils de chauffage aux radiateurs de la maison, l'électronique évoluée dans les appareils à granulés qui permet d'effectuer des contrôles à distance et de gérer la puissance par rapport à l'installation de chauffage existante, sont quelques exemples du développement constant et continu pour garantir les meilleures performances.

La Nordica-Extraflame products are the most modern and sophisticated way to heat the home.

Designed, constructed and tested exclusively in Italy, in-depth research into constructional and environmental aspects ensures low emissions and minimum pollution, combined with top efficiency and great savings.

The constant and continuous developments aimed at improving performance include innovations for perfect combustion of wood or pellets, the possibility of connecting the thermostats to radiators and advanced electronics in pellet fired products with the possibility of remote control and optimising power according to the existing heating installation.

Die Produkte La Nordica-Extraflame repräsentieren die modernsten und ausgeklügeltsten Lösungen für die Heizung in Privatbereichen.

Sie werden ausschließlich in Italien konstruiert, hergestellt und getestet und sind dank sorgfältiger Forschungen, was bauliche Lösungen und Umweltschutz betrifft, in der Lage, geringe Emissionen und minimale Umweltbelastung sowie beste Leistungen und große Kosteneinsparung zu garantieren.

Innovationen für die perfekte Verbrennung von Holz oder Pellets, die Möglichkeit, Thermostate an die Heizkörper der Wohnung anzuschließen, die Hightech-Elektronik der Produkte mit Pelletfeuerung, die auch die Fernbedienung sowie das Management der optimalen Leistung in Bezug auf die bestehende Heizungsanlage ermöglichen, sind nur einige Beispiele für die stetige und konstante Weiterentwicklung, um beste Ergebnisse zu erzielen.

Los productos La Nordica-Extraflame representan las soluciones más modernas e investigadas para la calefacción doméstica.

Diseñados, fabricados y probados exclusivamente en Italia, gracias a unas cuidadosas investigaciones en el aspecto constructivo y ecológico pueden asegurar bajas emisiones y contaminación mínima así como el mejor rendimiento y un gran ahorro económico.

Innovaciones para una perfecta combustión de la leña o del pellet, la posibilidad de conexión entre productos térmicos y radiadores de casa, la electrónica evolucionada en los productos a base de pellet también para realizar controles a distancia y gestionar la potencia óptima respecto a la instalación térmica existente, son sólo algunos ejemplos del desarrollo continuo y constante para ir hacia las mejores prestaciones.

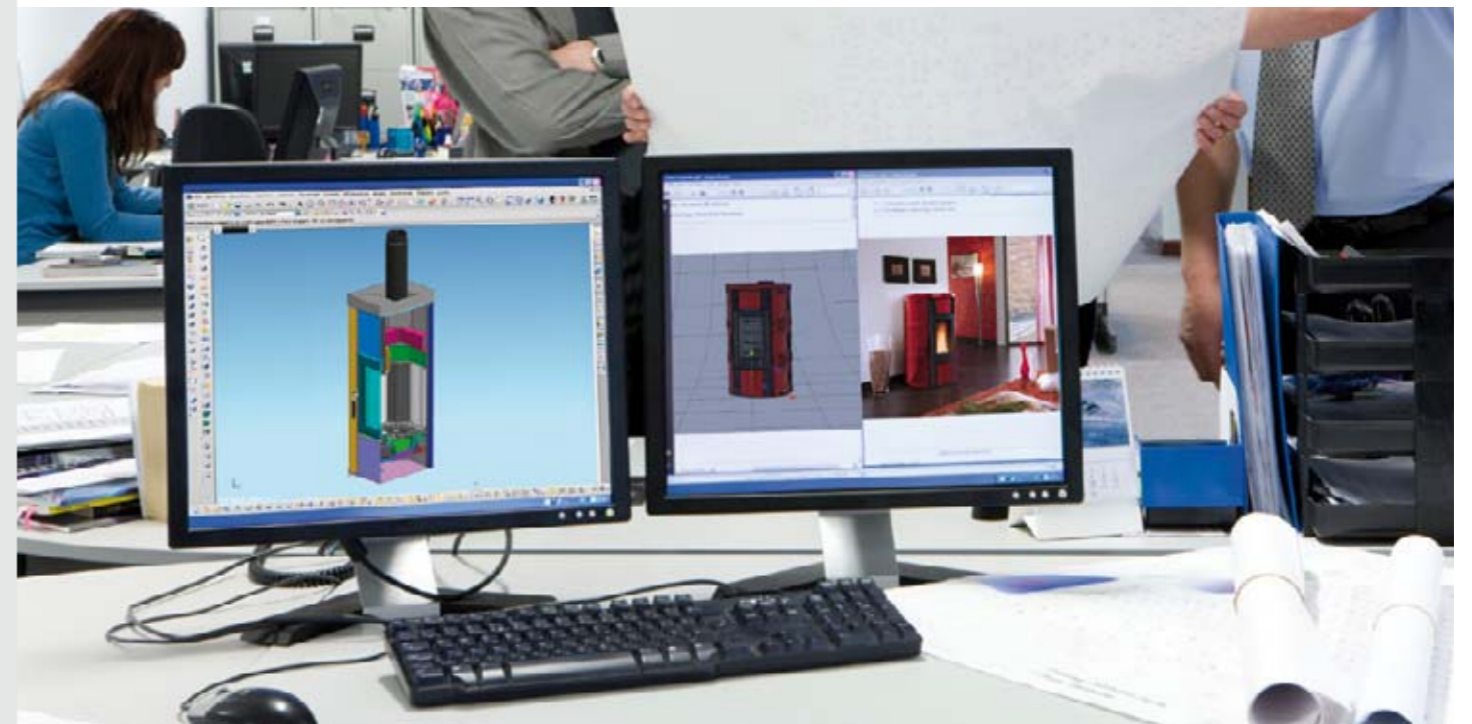

LA NORDICA-EXTRAFLAME PER AGEVOLARE LA COMPrensIONE DEI VARI PLUS, HA SINTETIZZATO LE DOTAZIONI TECNOLOGICHE DEI PROPRI PRODOTTI IN UNA SERIE DI SEMPLICI ICONE UTILI ALL'IMMEDIATA INDIVIDUAZIONE DELLA TECNOLOGIA LEGATA AL SINGOLO PRODOTTO.

To facilitate comprehension of the various pluses, La Nordica-Extraflame has summarised the technological features of its products in a series of simple icons to immediately identify the technology associated with any particular product.

La Nordica-Extraflame, afin de faciliter la compréhension des vari plus, a développé une série d'icônes simples représentant les équipements technologiques de ses appareils, et qui permettent de voir immédiatement la technologie liée au produit.

Zum besseren Verständnis der zahlreichen Vorteile hat La Nordica-Extraflame die technischen Eigenschaften seiner Produkte in einer Reihe einfacher Symbole zusammengefasst, die helfen, die technischen Merkmale jedes einzelnen Produkts auf einen Blick zu erkennen.

La Nordica-Extraflame para facilitar la comprensión de los distintos plus, ha sintetizado las dotaciones tecnológicas de sus productos en una serie de sencillos iconos útiles para la inmediata individualización de la tecnología ligada a cada uno de los productos.



ASC Active System Combustion

È un particolare sistema di connessione che permette di prelevare dall'esterno l'aria di combustione dell'apparecchio. Questo significa un migliore rendimento ed una maggiore sicurezza per l'utente.

ASC Active System Combustion

It is a particular connection system that allows the appliance combustion air to be taken from the outside. This means higher efficiency and more safety for the user.

ASC Active System Combustion

System de raccordement particulier qui permet de prélever l'air de combustion de l'appareil à l'extérieur. Cela signifie un meilleur rendement et une plus grande sécurité pour l'utilisateur.

ASC Active System Combustion

Besonderes Verbindungssystem, das das Ansaugen der Verbrennungsluft des Ofens von außen ermöglicht. Dies bedeutet eine bessere Leistung des Geräts und eine höhere Sicherheit für den Benutzer.

ASC Active System Combustion

Es un particular sistema de conexión que permite de retirar desde el externo el aire de combustión del aparato. Esto significa mas rendimiento y una mayor seguridad por el utilizador.



PCS Post Combustion System

Il sistema di combustione sviluppato da La Nordica-Extraflame consente, grazie ad un sistema di aria secondaria/terziaria, una post combustione in grado di abbattere drasticamente le emissioni e quindi di rispettare le più restrittive normative europee.

PCS Post Combustion System

The combustion system developed by La Nordica-Extraflame allows, thanks to a secondary/tertiary air system, a post-combustion capable of strongly reducing emissions and therefore of respecting the most restrictive European rules.

PCS Post Combustion System

Le système de combustion développé par La Nordica-Extraflame permet, grâce à un système d'air secondaire/tertiaire, une post-combustion en mesure de réduire drastiquement les émissions et donc de respecter les normes européennes les plus sévères.

PCS Post Combustion System

Das von La Nordica-Extraflame entwickelte Verbrennungssystem ermöglicht dank eines Zweiluft-/Drittluftsystems eine Nachverbrennung, die die Emissionen beträchtlich reduziert, wodurch die strengsten europäischen Rechtsvorschriften eingehalten werden.

PCS Post Combustion System

El sistema de combustión desarrollado por La Nordica-Extraflame permite, gracias a un sistema de aire secundario/terciario, una post combustión capaz de bajar drásticamente las emisiones y entonces de respetar las más estrechas normativas de Europa.



DSA Dispositivo Sicurezza Automatico

È un dispositivo di sicurezza per l'abbattimento repentino della temperatura dell'acqua secondo le normative vigenti. Viene consentita così l'installazione a vaso di espansione chiuso di un apparecchio a combustibile solido (legna).

DSA Automatic Safety Device

It is a safety device created to quickly reduce water temperature, according to rules in force. Thanks to this system a close expansion vessel installation of a solid fuel appliance (wood) is allowed.

DSA Automatic Safety Device

C'est un dispositif de sécurité permettant de diminuer rapidement la température de l'eau selon les normes en vigueur. Cela permet donc d'installer un appareil à combustible solide (bois) à vase d'expansion fermé.

DSA Automatic Safety Device

Sicherheitsvorrichtung für die plötzliche Senkung der Wassertemperatur gemäß den geltenden gesetzlichen Bestimmungen. Auf diese Weise wird die Installation mit geschlossenem Ausdehnungsgefäß eines Geräts mit Festbrennstoff (Holz) ermöglicht.

DSA Automatic Safety Device

Es un dispositivo de seguridad para bajo repentino de la temperatura de el agua según las normativas en curso. Se queda así consentida la instalación a vaso cerrado de un aparato a combustible sólido (leña).



BBC Bring the Breath into the Combustion

Sistema di prese d'aria che preleva dall'esterno l'aria fresca per la combustione immettendola direttamente nell'apparecchio. Questo sistema permette di installare i prodotti anche nelle moderne case a basso consumo energetico, inoltre rende l'utilizzo della stufa più sicuro poiché non viene bruciato l'ossigeno del locale dov'è installato l'apparecchio evitando inoltre dispersioni termiche.

BBC Bring the Breath into the Combustion

Air intakes system that takes combustion fresh air from the outside leading it directly into the appliance. This system allows to install our appliances also in the newest low energy consumption houses. Moreover, it makes the stove use safer as the oxygen of the installation room is not burnt and avoids heat loss as well.

BBC Bring the Breath into the Combustion

Système de prises d'air qui prélève à l'extérieur l'air frais pour la combustion et l'introduit directement dans l'appareil. Ce système permet d'installer les produits aussi dans les maisons à basse

consommation d'énergie, en outre il rend l'utilisation du poêle plus sur, car on ne consomme pas l'oxygène de la pièce où est installé l'appareil, en évitant aussi les dispersions de chaleur.

BBC Bring the Breath into the Combustion

Ein Luftzufuhrsystem, das Frischluft für die Verbrennung von außen bezieht und direkt in das Gerät einleitet. Dank dieses Systems können die Produkte auch in modernen Energiesparhäusern installiert werden. Zudem macht es den Betrieb des Ofens sicherer, weil der Sauerstoff im Raum, wo das Gerät installiert ist, nicht verbrannt wird und das vermeidet auch Wärmeverluste.

BBC Bring the Breath into the Combustion

Sistema de toma de aire que retira desde el externo aire fresco para la combustión guiándola directamente en el aparato. Este sistema permite de instalar el producto también en las modernas casas a bajo consumo energético, realizando además un uso mas seguro de la estufa en cuanto no viene quemado el oxígeno de sitio de instalación del aparato evitando también dispersiones térmicas.



CGC Clean Glass Control

È un sistema che tramite uno specifico percorso d'aria preriscaldato evita efficacemente la formazione di depositi sul vetro della porta fuoco.

CGC Clean Glass Control

It is a system that thanks to a specific way of pre-heated air efficiently avoids the deposits formation on the hearth door glass.

CGC Clean Glass Control

C'est un système qui grâce à un parcours spécifique d'air préchauffé évite efficacement l'encrassement de la vitre du foyer.

CGC Clean Glass Control

System, das die Schmutzablagerung am Sichtfenster des Feuerraums mittels eines spezifischen vorgeheizten Luftstroms wirksam vermeidet.

CGC Clean Glass Control

Es un sistema que a través de un específico recorrido de aire precalentada evita eficazmente la formación de depósitos sobre el cristal de la puerta del hogar.

N.B.: Le caratteristiche tecniche vanno verificate per ogni singolo prodotto - The technical characteristics must be verified for each individual product - Les caractéristiques techniques sont vérifiées pour chaque appareil - Die technischen Eigenschaften sind für jedes einzelne Produkt zu prüfen - Las características técnicas se verifican para cada uno de los productos



RDT Resistant Door at the Time

Le porte dei prodotti La Nordica-Extraflame sono realizzate in ghisa di qualità elevata. Questo materiale, anche se sottoposto a forti sollecitazioni termiche, non subisce dilatazioni o alterazioni della propria forma. In tale ragione la porta in ghisa garantisce l'assenza dei problemi legati alla deformazione (rumori, etc..) e soprattutto una costante tenuta, requisito fondamentale per un corretto funzionamento di prodotti con basse emissioni ed alto rendimento.

RDT Resistant Door at the Time

La Nordica-Extraflame appliances doors are manufactured in high quality cast iron. This material, even undergoing to strong thermic stress, are not subjected to expansion or shape changes. For this reason the cast iron door assures the absence of problems linked to material deformation (noise, etc) and above all a constant resistance, which is a basic requirement for the correct functioning of low emissions and high performance products.

RDT Resistant Door at the Time

Les portes des produits La Nordica-Extraflame sont réalisées en fonte de haute qualité. Ce matériel peut supporter des sollicitations thermiques très fortes sans subir, cependant, des dilatations ou altérations de sa forme. Pour cette raison la porte en fonte garantit l'absence de problèmes liés à la déformation (bruit, etc..) et surtout une tenue constante, ce qui est une qualité essentielle pour un correct fonctionnement des produits avec basses émissions et rendement élevé.



PRS Power Radiant System

Sistema scambiatore ad altissima efficienza di cessione del calore in ambiente. L'aria fredda, a contatto con la grande superficie radiante in ghisa, si riscalda e sale verso l'alto creando un ciclo continuo detto "moto convettivo". La convezione distribuisce così l'aria calda all'interno dell'ambiente dove è installato l'apparecchio in tempi rapidi ed ottimizzando il rendimento.

PRS Power Radiant System

Exchanger System at high efficiency of warmth releasing to the room. The cold air warms up against the big radiant surface in cast iron and goes up by creating a continuous cycle named as "convective motion". This way, convection distributes warm air quickly and efficiently into the room where the appliance is installed.

PRS Power Radiant System

Système échangeur à haute efficacité qui assure une transmission de chaleur à l'air ambiant. L'air froid au contact de la très grande surface rayonnante en fonte se réchauffe et remonte vers le en créant un cycle continu appelé « mouvement de convection ». La convection diffuse donc l'air chaud dans la pièce où est installé l'appareil très rapidement et en optimisant le rendement.

RDT Resistant Door at the Time

Dieses Material, auch bei hohen thermischen Entspannung untergezogen, unterliegt keine Ausdehnungen oder Veränderung seiner Form. Aus diesem Grund gewährleistet die Gusseisentür, die Vermeidung der Ausdehnungs- oder Geräuschprobleme und eine konstante hermetische Abdichtung. Diese Eigenschaft ist bei Niedrigemissionsprodukten mit hohem Wirkungsgrad für den einwandfreien Betrieb unverzichtbar.

RDT Resistant Door at the Time

Las puertas de los productos La Nordica-Extraflame son realizadas en fundición de alta calidad. Este material, aunque sometido a fuertes sollicitaciones térmicas, no sufre dilataciones o cambios de forma. Por eso la puerta en fundición garantiza la ausencia de problemas relacionados con la deformación (ruidos, etc.) y sobre todo una tenuta constante, requisito fundamental para un correcto funcionamiento de los productos con bajas emisiones y alto rendimiento.

PRS Power Radiant System

Ein Wärmetauschersystem mit hocheffizienter Abgabe der Wärme an die Umgebung. Die mit der großen Gusseisenheizfläche in Berührung kommende Kaltluft wird erhitzt, steigt nach oben und erzeugt eine als Konvektion bezeichnete kontinuierliche Strömung. Die Konvektion sorgt für die schnelle Verteilung der Warmluft im Aufstellraum mit einer Leistungsoptimierung.

PRS Power Radiant System

Sistema intercambiador de altísima eficiencia para la transferencia del calor en el ambiente. El aire frío, cuando en contacto con la grande superficie radiante en fundición se calienta y sube hacia arriba creando un ciclo continuo llamado "moto convectivo". La conveccion distribuye así el aire caliente en el ambiente adonde se queda instalado el aparato rápidamente y optimizando el rendimiento.



Nordiker™

La Nordica-Extraflame, per la realizzazione dei refrattari sulle pareti del focolare, utilizza un particolare materiale denominato Nordiker™. Questo prodotto, grazie alla grande capacità termica, permette di raggiungere elevate temperature nella camera di combustione abbattendo così le emissioni in ambiente.

Nordiker™

La Nordica-Extraflame uses a special material called Nordiker™ for the production of hearth walls refractories. This product, thanks to its high thermal capacity, allows to reach high temperatures inside the combustion chamber so that room emissions are reduced.

Nordiker™

La Nordica-Extraflame utilise un matériau spécial dit Nordiker™ pour réaliser les réfractaires des parois du foyer. Ce produit, grâce à une élevée capacité thermique, permet d'avoir des températures élevées dans la chambre de combustion et baisser de cette façon les émissions.

Nordiker™

La Nordica-Extraflame verwendet für die feuerfesten Wände der Feuerstelle eines bestimmten Materials bezeichnet Nordiker™, welches dank seiner Beständigkeit/ thermischen Kapazität, hohe Verbrennungstemperaturen und die Emissionsminderung in die Umwelt ermöglicht.

Nordiker™

La Nordica-Extraflame, para la realización de los refractarios sobre las paredes del hogar, usa un particular material llamado Nordiker™. Este producto, gracias a su grande capacidad térmica, permite de alcanzar altas temperaturas en la cámara de combustión bajando así las emisiones en el ambiente.

Le Certificazioni

Certificates / Les Certifications / Zertifizierungen / Las Certificaciones



Tecnologia Applicata

Certificazioni ottenute dai più prestigiosi marchi di qualità internazionali fanno sì che l'acquisto di un prodotto La Nordica-Extrafame diventi una garanzia assoluta sia in Italia che all'estero. Vantare tali marchi significa infatti essere in grado di rispettare i rigorosi dettami di qualità generale, resa termica e il rispetto dei parametri delle

Applied Technology

When buying a La Nordica-Extrafame product in Italy or abroad, certification with the most prestigious international quality marks provides an absolute guarantee. These marks mean our products comply with the severe general quality and heat output criteria and respect the carbon monoxide emission parameters established by the

Technologie Appliquée

Les certifications et labels obtenus auprès des organismes internationaux les plus prestigieux font que l'achat d'un produit La Nordica-Extrafame devient une garantie absolue aussi bien en Italie qu'à l'étranger. Obtenir ces labels signifie en effet être en mesure de satisfaire aux exigences de qualité générale, rendement thermique et respect des taux d'émissions de monoxyde

Angewandte Technologie

Zertifizierungen der bedeutendsten internationalen Qualitätsmarken machen den Kauf eines La-Nordica-Extrafame-Produkts zu einer absolut sicheren Angelegenheit, in Italien wie auch im Ausland. Diese Zertifizierungen vorweisen zu können bedeutet, die strengen allgemeinen Vorgaben, was Qualität und Wärmeleistung betrifft, zu erfüllen sowie die von den anspruchsvollsten europäi-

Tecnologia Applicata

Las certificaciones obtenidas de las marcas de calidad de mayor prestigio hacen que la adquisición de un producto La Nordica-Extrafame, se convierta en una garantía absoluta tanto en Italia como en el extranjero. Contar con dichas marcas significa ser capaz de respetar las rigurosas disposiciones de calidad general, rendimiento térmico y respeto de los parámetros de emisión de monóxido de

emissioni di monossido di carbonio nell'atmosfera richiesti dalle più restrittive normative europee. L'ottenimento di suddetti marchi è stato raggiunto grazie a continue ricerche e controlli effettuati dai tecnici utilizzando gli strumenti più avanzati. L'ininterrotta ricerca e gli innumerevoli test garantiscono un livello di sicurezza assoluto ai prodotti.

most rigorous European standards.

The marks have been obtained thanks to constant research and testing by our technical team using the most advanced instruments.

Uninterrupted research and numerous tests guarantee the absolute safety of our products.

de carbone dans l'atmosphère, prescrites par les normes internationales les plus exigeantes. Ces labels ont été obtenus grâce à une recherche constante et à des contrôles effectués par nos techniciens à l'aide d'instruments à la pointe de la technologie. La recherche continue et les très nombreux essais garantissent un niveau de sécurité absolu de nos produits.

schen Vorschriften verlangten Parameter für die Kohlenmonoxidemissionen in die Atmosphäre einzuhalten. Die genannten Auszeichnungen wurden dank kontinuierlicher Forschungen und Prüfungen durch unsere Techniker und den Einsatz modernster Instrumente erreicht. Stetige Forschung und zahllose Tests garantieren unseren Produkten ein absolutes Sicherheitsniveau.

carbono a la atmósfera, exigidos por las normas europeas más restrictivas. El haber logrado estas marcas ha sido posible gracias a la constante investigación y a los controles realizados por los técnicos valiéndose de instrumental de vanguardia. Una investigación sin interrupción sumada a innumerables pruebas garantiza el nivel de seguridad absoluto de los productos.



EN 13240

EN 12815

EN 303-5

Marchio di conformità alle norme Europee. Mark of conformity to European standards. Label de conformité aux normes européennes. Konformitätszeichen europäische Normen. Marca de conformidad con las normas europeas.

Norma Europea di riferimento per stufe a combustibile solido. European reference standard for roomheaters fired by solid fuel. Norme européenne relative aux poêles à combustible solide. Europäische Norm für Raumheizer für feste Brennstoffe. Norma Europea para estufas con combustible sólido.

Norma Europea di riferimento per cucine a legna. European reference standard for residential cookers fired by solid fuel. Norme européenne relative aux cuisinières à bois. Europäische Bezugsnorm für Herde für feste Brennstoffe. Norma europea de referencia para cocinas de leña.

Norma Europea di riferimento per le caldaie a legna e pellet. European reference standard for heating boilers for solid fuels. Norme européenne relative aux chaudières à bois et granulés. Europäische Bezugsnorm für Heizkessel für feste Brennstoffe. Norma europea de referencia para las calderas de leña y pellet.

15a B-VG



Conformità all' art. 15° della legge costituzionale federale Austriaca sulle misure di salvaguardia ambientale.

Compliance with article 15 of the Austrian federal constitutional law on environmental protection measures.

Conformité à l'art. 15a de la loi constitutionnelle fédérale autrichienne sur la protection de l'environnement.

Konformität gemäß § 15 des österreichischen Bundesverfassungsgesetzes über Umweltschutzmaßnahmen.

Conformidad con el art. 15 de la ley constitucional federal austriaca sobre las medidas de protección medioambiental.

Certificazione di qualità dell'organismo elvetico di protezione antincendio.

Quality certification from the Swiss fire protection body.

Label de qualité de l'organisme helvétique de protection contre l'incendie.

Qualitätszertifizierung der schweizerischen Vereinigung kantonaler Feuerversicherungen.

Certificación de calidad del organismo helvético de protección contra incendios.

Certificazione del Dipartimento per l'Inquinamento ed attività Alimentari ed Agricole Inglese. Certificate from the English Department for Environment, Food and Rural Affairs.

Label du Département de l'Environnement, de l'Alimentation et des Affaires rurales britannique.

Zertifizierung des britischen Ministeriums für Umwelt, Ernährung und Angelegenheiten des ländlichen Raums.

Certificación del Departamento para la Contaminación y actividades alimentarias y agrícolas inglés.

Certificazione ente inglese per il controllo degli impianti a legna e pellet.

Certificate from the English official body for the control of wood and pellet fired appliances.

Label organisme anglais pour le contrôle des installations à bois et granulés.

Zertifizierung der englischen Zulassungsstelle für die Prüfung von Anlagen mit Holz- und Pelletfeuerung.

Certificación del ente inglés para el control de las instalaciones con leña y pellet.



GOST P8.568-77

BImSchV

Certificazione di omologa norvegese. Norwegian type approval certificate. Label d'homologation norvégien. Norwegische Produktzertifizierung. Certificación de homologación noruega.

Certificato di conformità alle normative di sicurezza russe. Certificate of compliance with Russian safety regulations. Label de conformité aux normes de sécurité russes. Zertifizierung der Konformität gemäß den russischen Sicherheitsnormen. Reglamento alemán para la reducción de seguridad rusas.

Regolamento tedesco per il contenimento delle emissioni. German regulations on controlling emissions. Règlement allemand pour la limitation des émissions. Deutsche Verordnung über die Einschränkung der Emissionen. Reglamento alemán para la reducción de las emisiones.

Laboratori Di Omologazione

Type Approval Laboratories / Laboratoires D'homologation / Prüfstellen / Las Certificaciones



Ricerca e sviluppo

Research And Development / Recherche Et Développement
Forschung Und Entwicklung / Investigación Y Desarrollo



Il Dipartimento di Ricerca e Sviluppo La Nordica-Extrafame è costantemente impegnato a sviluppare, testare e migliorare le performance degli apparecchi, aggiornando costantemente le metodologie di sviluppo e la struttura operativa.

Product Lifecycle Management

È stato introdotto un nuovo sistema di lavoro collaborativo, PLM, basato su un sistema informativo il quale si interfaccia con tutte le tecnologie, i processi produttivi ed organizzativi del Gruppo.

Tale sistema permette di gestire strategicamente il ciclo di vita del prodotto dall'ideazione, allo sviluppo, al lancio sul mercato, fino ad eventuali modifiche, ottimizzando la qualità ed i tempi di realizzazione.

Ansys Cfd Flo

Il software Ansys Cfd Flo Fluid dynamics permette di valutare in anticipo ed in 3D, lo scambio termico ed il rendimento fin dalla fase progettazione di generatori più performanti e con ridotte emissioni.

Component Engine

Si tratta di un software per la gestione e creazione di cataloghi interattivi per le parti di ricambio. I vantaggi offerti da questo nuovo strumento di lavoro consistono nell'azzeramento degli errori legati alla gestione dell'ordine, riduzione del tempo di fermo macchina e riduzione generale dei tempi e costi per l'evasione dell'ordine.

The La Nordica-Extrafame R&D department is constantly committed to developing, testing and improving the performance of the company's appliances, maintaining its development methods and operational structure constantly up to date.

Product Lifecycle Management

A new collaborative work system known as PLM has been introduced, based on an information system interfacing with all the Group's technologies and production and organisational processes.

It enables the product's lifecycle to be managed strategically from conception through development and market launch to possible modifications, optimising quality and production times.

Ansys Cfd Flo

The Ansys Cfd Flo Fluid Dynamics software enables the heat exchange and efficiency of high performance low emission heat generators to be evaluated in advance and in 3D from the design phase.

Component Engine

This software manages and creates interactive spare parts catalogues. The new work tool eliminates order management errors, reduces machine down time and generally reduces the times and costs of order fulfilment.



Die Forschungs- und Entwicklungsabteilung von La Nordica-Extrafame engagiert sich stetig für die Entwicklung, Prüfung und Verbesserung der Leistungen der Geräte mit der ständigen Aktualisierung der Entwicklungsmethoden und der Betriebsabläufe.

Product-Lifecycle-Management

Eingeführt wurde ein neues kooperationsbasiertes Arbeitssystem, das Product-Lifecycle-Management oder PLM, das auf einem Informationssystem beruht, das an alle Technologien, Produktions- und Organisationsprozesse des Konzerns angebunden wird. Dieses System ermöglicht das strategische Produktlebenszyklusmanagement vom Konzept über die Entwicklung und das Inverkehrbringen bis zu etwaigen Änderungen mit der Optimierung der Qualität und der Realisierungszeiten.

Le Département Recherche et Développement La Nordica-Extrafame a pour mission constante de développer, tester et améliorer les performances des appareils, en recherchant et en mettant en œuvre de nouvelles méthodes et en réorganisant la structure opérationnelle.

Product Lifecycle Management

Le nouveau système de travail collaboratif (PLM) mis en place se base sur un système d'information qui s'interface avec toutes les technologies, les processus de production et d'organisation du Groupe.

Ce système permet de gérer stratégiquement le cycle de vie de l'appareil de la conception et développement au lancement sur le marché, jusqu'aux modifications éventuelles, en optimisant la qualité et les temps de réalisation.

Ansys Cfd Flo

Le logiciel Ansys Cfd Flo Fluid Dynamics permet d'estimer à l'avance et en 3D l'échange de chaleur et le rendement dès la conception de générateurs plus performants et moins polluants.

Component Engine

Il s'agit d'un logiciel pour la gestion et la création de catalogues interactifs pour les pièces détachées. Ce nouvel outil de travail permet d'éliminer les erreurs liées à la gestion de la commande, une réduction du temps d'arrêt de la machine et une réduction générale des délais et coûts de traitement de la commande.

Ansys Cfd Flo

Mithilfe der Software Ansys Cfd Flo Fluid dynamics können im Voraus in 3 D der Wärmetausch und der Wirkungsgrad bereits in der Konstruktionsphase der leistungsstärksten Heizsysteme mit reduzierten Emissionen bewertet werden.

Component Engine

Es handelt sich um eine Software für das Management und die Erstellung von interaktiven Ersatzteilkatalogen. Die Vorteile, die dieses neue Arbeitsmittel bietet, betreffen die Reduzierung der Fehlerquote bei der Bearbeitung einer Bestellung auf null, die Reduzierung der Maschinenstillstandszeiten und die allgemeine Reduzierung des Zeit- und Kostenaufwands zur Auftragsbearbeitung.

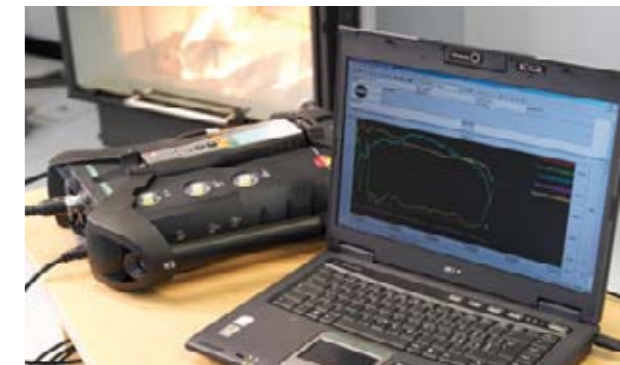

El Departamento de Investigación y Desarrollo de La Nordica-Extrafame trabaja continuamente para desarrollar, probar y mejorar las prestaciones de los aparatos, actualizando constantemente los métodos de desarrollo y la estructura operativa.

Product Lifecycle Management

Se ha introducido un nuevo sistema de trabajo de colaboración, PLM, basado en un sistema informativo que se conecta con interfaz con todas las tecnologías, los procesos productivos y organizativos del Grupo.

Dicho sistema permite gestionar estratégicamente el ciclo de vida del producto desde la concepción, el desarrollo, el lanzamiento al mercado, hasta las eventuales modificaciones, optimizando la calidad y los tiempos de realización.

Ansys Cfd Flo

El software Ansys Cfd Flo Fluid dynamics permite valorar con antelación y en 3D, el intercambio térmico y el rendimiento desde la fase de proyecto de generadores con más prestaciones y menos emisiones.

Component Engine

Se trata de un software para la gestión y la creación de catálogos interactivos para las piezas de recambio. Las ventajas que ofrece este nuevo instrumento de trabajo consisten en la puesta a cero de los errores ligados a la gestión de las órdenes, la reducción del tiempo de paro de la máquina y la reducción general de los tiempos y los costes para la ejecución de la orden.



La formazione

Training / La Formation / Schulung / La Formación

Il nostro pensiero è sempre rivolto al consumatore.

Formazione e informazione sui prodotti sono indispensabili sia per i tecnici che curano installazione e manutenzione, sia per il personale che deve indirizzare il cliente nella scelta del proprio apparecchio.

Per queste ragioni nasce il Customer Service, dipartimento dedicato alla formazione e all'aggiornamento su temi tecnici e commerciali con corsi tenuti da docenti preparati, durante tutto l'anno, presso l'apposita sede Training Center dotata di sei aggiornati laboratori interattivi e tematici.



Our thoughts always go to the consumer.

Product training and information are indispensable for both the technical team performing installation and maintenance and for those responsible for advising customers in choosing an appliance.

The company has therefore set up a Customer Services department, dedicated to providing training and refresher courses held by expert teachers on technical and commercial themes throughout the year in the special Training Center with its six interactive themed laboratories.



Nous pensons toujours au consommateur.

Formation et information sur les produits sont indispensables aussi bien pour les techniciens qui s'occupent de l'installation et de l'entretien, que pour le personnel qui doit aider le client à choisir son appareil.

C'est pourquoi nous avons créé le Customer Service, dédié à la formation et au recyclage du personnel technique et commercial, avec des cours tenus, toute l'année, par des formateurs expérimentés, au Training Center équipé de 6 laboratoires modernes interactifs et thématiques.

Wir denken stets an den Verbraucher.

Schulung und Unterrichtung über die Produkte sind sowohl für die Techniker, die mit der Installation und der Instandhaltung beauftragt sind, als auch das Personal, das den Kunden bei der Auswahl des richtigen Geräts betreut, unverzichtbar.

Aus diesem Grund wurde die Abteilung Customer Service ins Leben gerufen, die sich mit der Schulung und Weiterbildung bezüglich technischer und den Vertrieb betreffender Angelegenheiten beschäftigt und hierzu das ganze Jahr über von erfahrenen Dozenten geleitete Kurse im eigens eingerichteten Trainingcenter veranstaltet, das über sechs nach modernsten Gesichtspunkten ausgestattete interaktive Themenlabors verfügt.



Siempre pensamos en el consumidor.

La formación y la información sobre los productos son indispensables tanto para los técnicos que se encargan de la instalación y el mantenimiento, como para el personal que debe ayudar al cliente en la elección de su aparato.

Por ello nace el "Customer Service" (Servicio de Atención al Cliente), departamento dedicado a la formación y la actualización sobre temas técnicos y comerciales con cursos impartidos por docentes preparados, a lo largo de todo el año, en la propia sede del Centro de Formación provista de seis laboratorios actualizados, interactivos y temáticos.



Centro Assistenza Tecnica

Customer Services Centres / Centre Assistance Technique
Technische Kundendienststellen / Centros De Asistencia Técnica

La nostra attenzione: consumatori sempre tutelati.

Per assicurare interventi rapidi e puntuali sui prodotti, negli anni il Gruppo La Nordica-Extrablame ha realizzato e consolidato sul territorio una capillare rete di tecnici qualificati e autorizzati, costantemente formati sulle novità dei prodotti e dei servizi e in filo diretto con il "Customer Service".

Quindi non solo "assistenza tecnica" ma consulenza estesa al sistema casa La Nordica-Extrablame. Il consiglio di un Centro Assistenza è prezioso e affidabile.

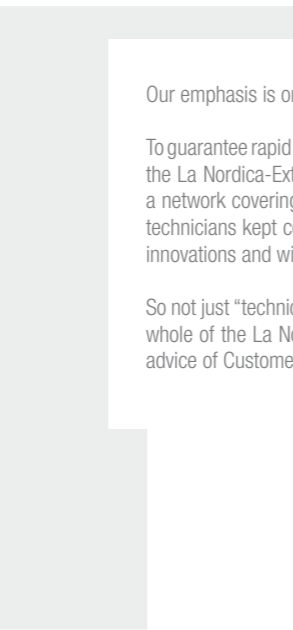

Our emphasis is on constant protection for consumers.

To guarantee rapid precise service on its products, over the years the La Nordica-Extrablame Group has set up and consolidated a network covering the whole of Italy with qualified authorised technicians kept constantly up-to-date on product and service innovations and with a hot line to "Customer Service".

So not just "technical assistance", but consultancy covering the whole of the La Nordica-Extrablame system for the home. The advice of Customer Services is valuable and reliable.

Notre attention: des consommateurs toujours protégés.

Afin d'assurer des interventions rapides et ponctuelles sur les produits le Groupe La Nordica-Extrablame a constitué et consolidé, au fil des années sur le territoire italien, un réseau de techniciens qualifiés et agréés, constamment formés sur les nouveautés des produits et des services et en contact direct avec le "Customer Service".

Donc "assistance technique" mais aussi conseils pour le système maison La Nordica-Extrablame. Les conseils des Centres d'Assistance sont précieux et fiables.

Bei uns steht der Verbraucherschutz an erster Stelle.

Um schnelle und präzise Kundendienstesätze an den Produkten zu garantieren, realisierte und konsolidierte der Konzern La Nordica-Extrablame im Lauf der Jahre in Italien ein engmaschiges Netzwerk qualifizierter und autorisierter Techniker, die ständig über neue Produkte und Dienstleistungen und mit direkter Verknüpfung mit dem „Customer Service“ geschult werden.

Geboten wird daher nicht nur „technischer Kundendienst“ sondern eine Komplettberatung für das Wohnungssystem La Nordica-Extrablame. Der Rat einer Kundendienststelle ist wertvoll und zuverlässig.



Nuestra atención: consumidores siempre protegidos.

Para asegurar intervenciones rápidas y puntuales sobre los productos, con los años el Grupo La Nordica-Extrablame ha realizado y consolidado en el territorio italiano una red capilar de técnicos cualificados y autorizados, constantemente formados sobre las novedades de los productos y de los servicios y en contacto directo con el "Customer Service".

Por lo tanto no sólo "asistencia técnica" sino asesoramiento extenso al sistema casa La Nordica-Extrablame. El asesoramiento de un Centro de Asistencia es precioso y fiable.

L'ambiente

The Environment / L'environnement / Umwelt / El Medio Ambiente



Numerosi sono i vantaggi che, oggi, si possono ottenere da un miglior sfruttamento delle zone boschive.

Il bosco è una risorsa abbondante, naturale e rinnovabile che può essere utilizzata attraverso la produzione di biomasse, materiali d'origine vegetale come legna e pellet.

Con la combustione di biomasse viene rilasciata la stessa quantità di CO2 che l'albero ha assorbito durante la propria crescita, contrariamente a quanto avviene con i combustibili fossili come carbone, petrolio e gas naturale, che rilasciano il carbonio accumulato in milioni di anni in tempi brevi, provocando lo squilibrio ambientale conosciuto come "effetto serra".

La combustione e gli altri processi che scompongono la legna non vanno quindi ad aumentare la presenza di CO2 nell'aria.

Curare e gestire il bosco: una garanzia ambientale per noi ed i nostri figli.

Better exploitation of wooded areas today offers numerous advantages. Woods are an abundant, natural, renewable resource which can be utilised by producing biomass, material of plant origin such as wood and pellets.

When biomass is burnt, the same quantity of CO2 as the tree has absorbed during its growth is released, unlike with fossil fuels such as coal, petrol and natural gas which when burnt release the carbon accumulated in millions of years extremely rapidly, causing environmental imbalance known as the "greenhouse effect".

Combustion and other processes which break down the wood do not therefore increase the amount of CO2 in the air.

Taking care of and managing woodland: an environmental guarantee for you and your children.



Une meilleure exploitation des forêts présente de nombreux avantages.

La forêt est une ressource abondante, naturelle et renouvelable qui peut être utilisée à travers la production de biomasse, des matériaux d'origine végétale comme le bois et les granulés.

La combustion de la biomasse dégage une quantité de CO2 équivalente à celle absorbée par l'arbre pendant sa croissance, contrairement aux combustibles fossiles comme le charbon, le pétrole et le gaz naturel, qui dégagent le carbone accumulé pendant des millions d'années en un temps très court, et sont responsables du déséquilibre environnemental appelé "effet de serre".

La combustion et les autres processus qui décomposent le bois n'augmentent pas la présence de CO2 dans l'air.

Soigner et gérer la forêt: une garantie environnementale pour nous et nos enfants.

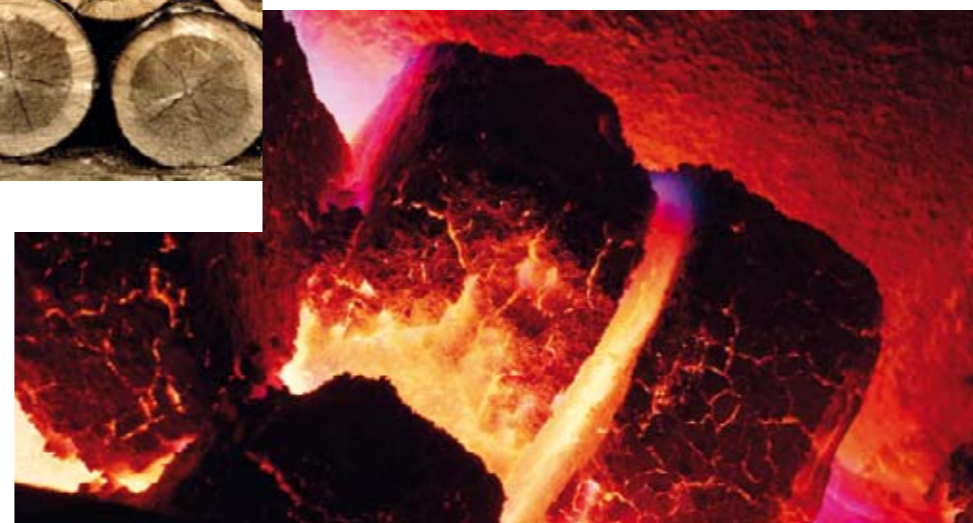

Heutzutage bietet die optimale Waldbewirtschaftung zahlreiche Vorteile.

Waldgebiete stellen eine reichhaltige, natürliche und erneuerbare Ressource dar, die anhand der Erzeugung von Biomassen, d. h. Materialien pflanzlichen Ursprungs wie Holz und Pellets, genutzt werden kann.

Bei der Verbrennung von Biomassen wird dieselbe Menge an CO2 freigesetzt, die der Baum während seines Wachstums absorbiert hat, im Gegensatz zu fossilen Brennstoffen wie Kohle, Erdöl und Naturgas, die den in Millionen von Jahren angesammelten Kohlenstoff in kurzer Zeit freisetzen, was sich als „Treibhauseffekt“ auf die Umwelt auswirkt.

Die Verbrennungen und die anderen Prozesse, die zur Zersetzung von Holz führen, erhöhen daher den CO2-Gehalt in der Luft nicht.

Optimale Pflege und Bewirtschaftung von Waldflächen: eine Umweltgarantie für uns und unsere Kinder.

Muchas son las ventajas que, actualmente, se pueden obtener de una mejor explotación de las zonas boscosas.

El bosque es un recurso abundante, natural y renovable que se puede usar mediante la producción de biomasa, materiales de origen vegetal como la leña y el pellet.

Con la combustión de biomasa se libera la misma cantidad de CO2 que el árbol ha absorbido durante su propio crecimiento, al contrario de lo que ocurre con los combustibles fósiles como el carbón, el petróleo y el gas natural que liberan en poco tiempo el carbono acumulado a lo largo de millones de años, provocando el desequilibrio medioambiental conocido como "efecto invernadero".

Por lo tanto, la combustión y los otros procesos que descomponen la leña no provocan un aumento de la presencia de CO2 en el aire.

Cuidar y gestionar el bosque: una garantía medioambiental para nosotros y nuestros hijos.

Legno e Pellet: l'energia rinnovabile

Wood and pellets: renewable energy / Bois et granulés: l'énergie renouvelable

Holz und pellets: erneuerbare energie / Leña y pellet: la energía renovable



Legno e pellet, grazie ad apparecchi altamente tecnologici e dalla massima resa, si riscoprono fonti di energia in grado di rispettare il ciclo naturale che parte dalla fotosintesi clorofilliana, rilasciando nell'atmosfera terrestre solo la quantità di anidride carbonica assorbita durante il proprio sviluppo. Combustibili naturali, rinnovabili, potenzialmente inesauribili, legno e pellet rappresentano un'opportunità per non logorare ulteriormente il nostro ecosistema già provato dalle emissioni delle altre attività umane.

I prodotti de La Nordica-Extraflame che valorizzano il consumo di biomasse, oggi possono contribuire ad educare la nostra civiltà, sempre più bisognosa di energia: indiscutibili sono i punti di forza che avvalorano la scelta di utilizzare prodotti per il riscaldamento a legna o pellet poiché partecipano a creare nuove opportunità di risparmio ambientale ed energetico e migliorare il rapporto con l'ambiente.



Dank Hightech-Geräten mit maximalem Wirkungsgrad präsentieren sich Holz und Pellets als Energiequellen, die in der Lage sind, den natürlichen Zyklus zu respektieren, der bei der Chlorophyll-Photosynthese beginnt, wobei in die Erdatmosphäre nur die während des eigenen Entwicklungsprozesses absorbierte Kohlendioxidmenge freigesetzt wird.

Holz und Pellets sind natürliche, erneuerbare und potenziell unerschöpfliche natürliche Brennstoffe, die eine Gelegenheit repräsentieren, um unser bereits durch die Emissionen anderer menschlicher Tätigkeiten stark belastetes Ökosystem nicht noch mehr zu schädigen.

Die Produkte von La Nordica-Extraflame werten den Biomassenverbrauch auf und können heute dazu beitragen, unseren Lebensstil, der mit einem zunehmend höheren Energiebedarf einhergeht, zu prägen: Die Vorteile des Einsatzes von mit Holz oder Pellets befeuerten Heizgeräten sind unbestreitbar, denn es werden neue Chancen zur Reduzierung der Umweltbelastung und zur Energieeinsparung sowie zur Verbesserung des Verhältnisses zur Umwelt geschaffen.



Leña y pellet, gracias a aparatos altamente tecnológicos y del máximo rendimiento, se redescubren fuentes de energía capaces de respetar el ciclo natural que parte de la fotosíntesis clorofílica, liberando a la atmósfera terrestre únicamente la cantidad de anhídrido carbónico absorbido durante su propio desarrollo.

Combustibles naturales, renovables, potencialmente inagotables, leña y pellet representan una oportunidad para no gastar posteriormente nuestro ecosistema que ya sufre las emisiones de las otras actividades humanas.

Los productos de La Nordica-Extraflame que valorizan el consumo de biomásas, pueden contribuir actualmente a educar nuestra civilización, que siempre necesita más energía: son sin duda los puntos fuertes que apoyan a la elección de usar productos para la calefacción con leña o pellet porque contribuyen a crear nuevas oportunidades de ahorro medioambiental y energético y a mejorar la relación con el medio ambiente.

High-tech, high efficiency appliances have enabled wood and pellets to be rediscovered as energy sources respecting the natural cycle which starts from chlorophyll photosynthesis, releasing only the quantity of carbon dioxide absorbed during growth into the Earth's atmosphere.

Natural, renewable and potentially inexhaustible fuels, wood and pellets represent an opportunity to avoid further stressing our ecosystem, already under pressure from emissions caused by other activities of man.

La Nordica-Extraflame products exploiting biomass consumption to the full can today contribute to educating our civilisation, ever more hungry for energy. There are incontrovertible strong points substantiating the choice to use wood or pellet burning heating appliances, as these help create new opportunities for protecting the environment, energy saving and improving our relationship with the environment.

Bois et granulés, grâce à des appareils hautement technologiques et au rendement maximal, sont des sources d'énergie en mesure de respecter le cycle naturel à partir de la photosynthèse chlorophyllienne, en dégageant dans l'atmosphère terrestre uniquement la quantité d'anhydride carbonique absorbée pendant son développement. Combustibles naturels, renouvelables, potentiellement inépuisables, le bois et les granulés de bois contribuent à préserver notre écosystème fortement menacé par les activités humaines.

Les appareils La Nordica -Extraflame, qui valorisent la biomasse, peuvent contribuer à sensibiliser notre civilisation, dont les besoins en énergie ne cessent d'augmenter: utiliser des appareils de chauffage au bois ou à granulés présente indiscutablement des avantages car ils permettent de préserver l'environnement, d'économiser de l'énergie et d'améliorer notre relation avec l'environnement.

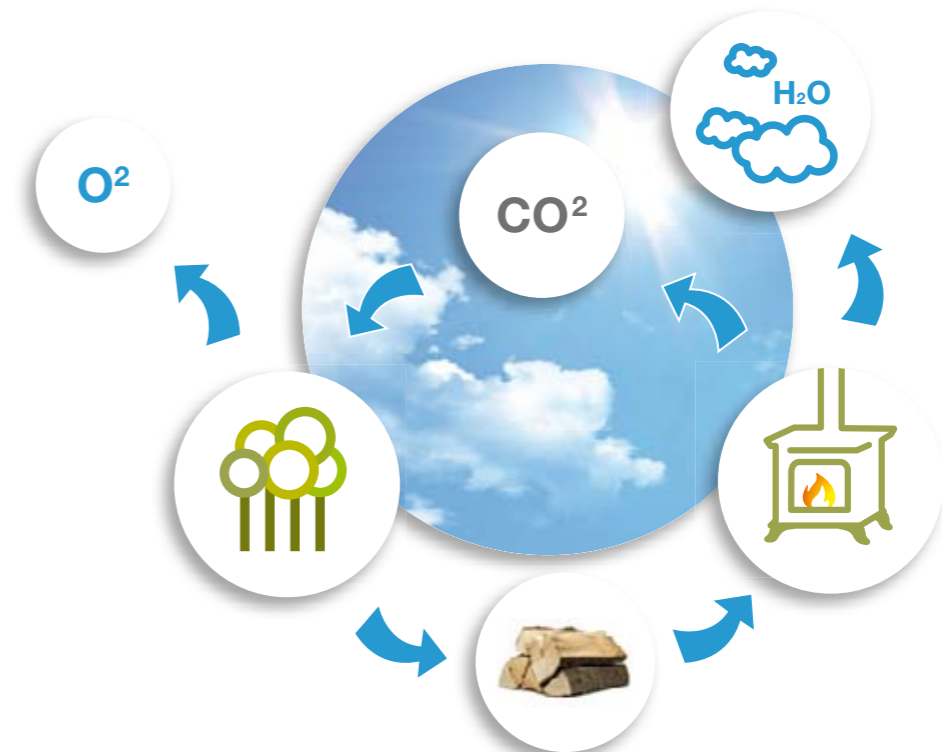

Saper scegliere

Pensare all'ambiente, anche di casa tua

Making the right choice

Think of the environment, even in your own home

Savoir choisir

Penser à l'environnement, chez vous aussi

Richtig wählen

Denken Sie an die Umwelt, auch in Ihren eigenen vier Wänden.

Saber elegir

Pensar en el medio ambiente, también de tu casa.

Verifica - Check - Vérifier - Prüfen Sie - Compruebe

1 Canna Fumaria

È l'elemento fondamentale per lo smaltimento dei fumi, deve essere costruita con materiali idonei alle alte temperature, possibilmente di forma circolare, con altezza minima senza curve di 4 metri.

Flue Pipe

Should be considered as the main element for smoke disposal. It must be built with material able to resist to high temperature, better with a circular shape, and 4 meters as minimal height without bends.

Conduit de fumée

C'est un élément essentiel pour l'évacuation des fumées, il doit être réalisé avec des matériaux résistant aux hautes températures, être si possible de section circulaire, et avoir une hauteur minimum sans coudes de 4 mètres.

Rauchabzug

Das grundlegende Element für die Rauchableitung muss aus für hohe Temperaturen geeigneten Materialien möglichst in runder Form und mit einer Mindesthöhe von 4 m ohne Biegungen hergestellt werden.

Humero

Es el elemento fundamental para la eliminación de los humos, debe construirse con materiales adecuados para las altas temperaturas, posiblemente de forma circular y con una altura mínima sin curvas de 4 metros.

2 Condotta di collegamento dei fumi

Per collegare il camino o la stufa alla canna fumaria il condotto deve avere un percorso il più breve possibile, con pochissimi tratti orizzontali e dello stesso diametro del collarino di attacco al camino.

Connection Pipe flue

Appliance flue connection pipe must be shortest, with few horizontal parts as possible and with the same diameter of the collar pipe appliance connection.

Conduit de raccordement

Il permet de raccorder la cheminée ou le poêle au conduit de fumée; son parcours doit être le plus court possible, avec très peu de tronçons horizontaux et son diamètre doit être égal à celui de la buse de raccordement.

Rauchrohrverbindungsleitung

Die Leitung für die Verbindung des Kamins oder Ofens mit dem Rauchabzug

muss so kurz wie möglich sein, darf nur wenige horizontale Abschnitte aufweisen und muss über den gleichen Durchmesser wie der Befestigungsring für den Kamin verfügen.

Conducto de conexión de los humos Para conectar la chimenea o la estufa al humero el conducto debe tener un recorrido lo más corto posible, con pocos tramos horizontales y del mismo diámetro que el collarín de conexión a la chimenea.

3 Prese d'aria

Verificare l'esistenza di una presa d'aria esterna di dimensioni opportune a garantire una completa ed efficiente combustione è una condizione necessaria per l'installazione di una stufa o camino.

Air Intake

It should be checked as correct appliance installation if do exist an external air intake big enough to offer a whole and efficient combustion.

Prises d'air

Une prise d'air extérieure de section adaptée, permettant d'assurer une combustion complète et efficace, est indispensable pour l'installation d'un poêle ou d'une cheminée.

Lufteintritt

Eine externe Luftzufuhr mit geeigneter Größe, um die vollständige, effiziente Verbrennung zu garantieren, ist eine unverzichtbare Voraussetzung für die Installation eines Ofens oder Kamins.

Tomas de aire

Antes de instalar una estufa o una chimenea debe comprobarse la existencia de una toma de aire externa, de dimensiones adecuadas, para garantizar una combustión completa y eficiente.

4 Comignolo

Posto alla sommità del camino deve avere sezione interna pari a quella del camino, la sezione d'uscita deve essere il doppio rispetto al diametro

Prises d'air

Une prise d'air extérieure de section adaptée, permettant d'assurer une combustion complète et efficace, est indispensable pour l'installation d'un poêle ou d'une cheminée.

Lufteintritt

Eine externe Luftzufuhr mit geeigneter Größe, um die vollständige, effiziente Verbrennung zu garantieren, ist eine unverzichtbare Voraussetzung für die Installation eines Ofens oder Kamins.

Tomas de aire

Antes de instalar una estufa o una chimenea debe comprobarse la existencia de una toma de aire externa, de dimensiones adecuadas, para garantizar una combustión completa y eficiente.

4 Comignolo

Posto alla sommità del camino deve avere sezione interna pari a quella del camino, la sezione d'uscita deve essere il doppio rispetto al diametro



Foto a solo scopo dimostrativo
Picture for illustrative purposes only.
Photo fournie uniquement à titre d'illustration.
Foto nur zur Veranschaulichung.
Foto meramente indicativa.



Scegli - Choose - Choisir - Wählen Sie - Elija

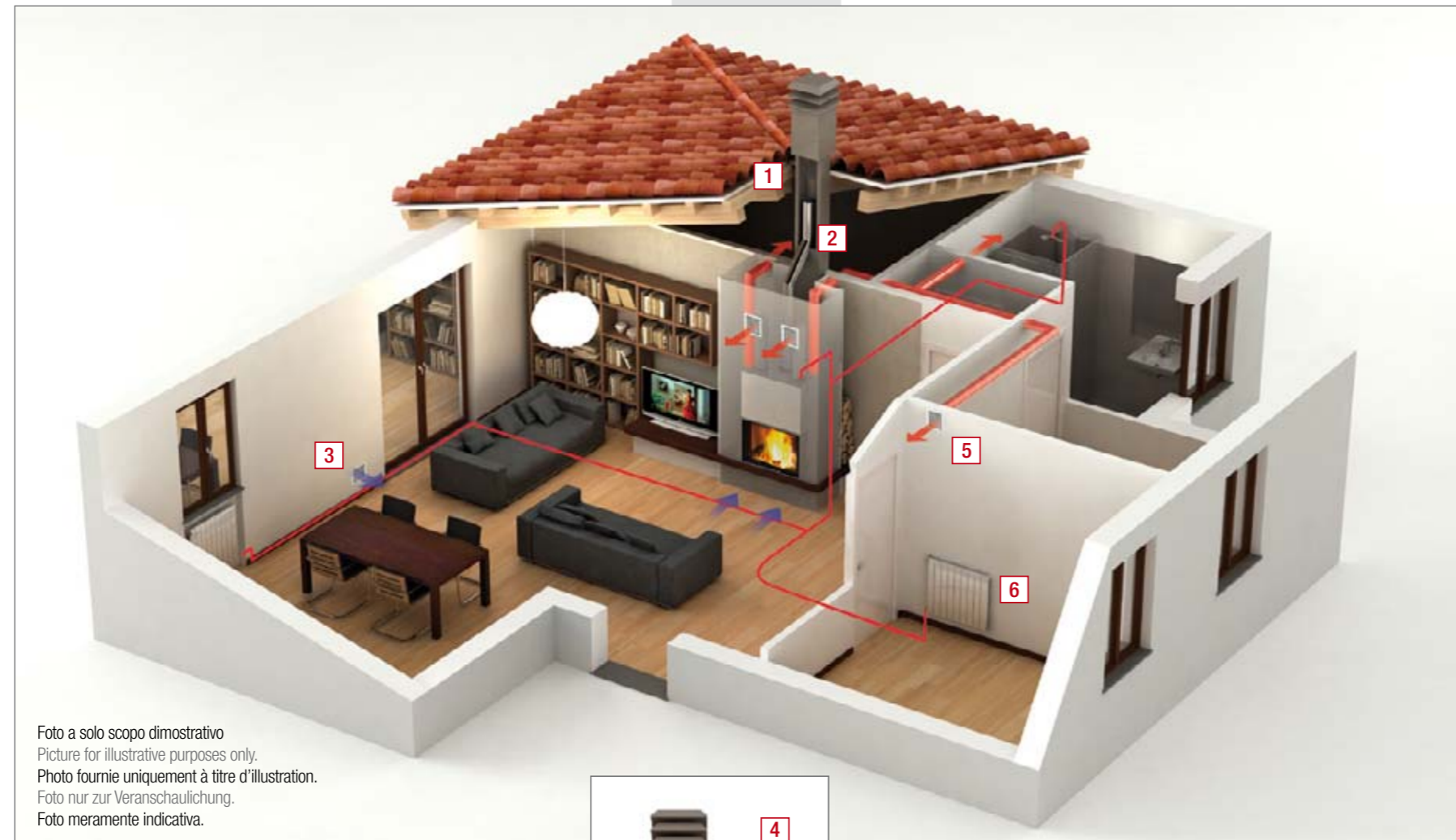

6 Termoprodotti

La scelta del termoprodotto da installare va fatta secondo specifici che esigenze individuali valutando minuziosamente la potenza termica complessiva necessaria all'impianto di riscaldamento ed il luogo dove va installata.

Thermo products

By choosing what thermo product to install, specific individual needs have to be considered in addition to a meticulous assess of the global thermal power needed by the heating system and of the installation place.

Appareils de chauffage

L'appareil de chauffage doit être choisi en fonction des exigences spécifiques et en déterminant minutieusement la puissance thermique nécessaire et l'endroit où il doit être installé.

Thermoprodukte

Die Wahl des zu installierenden Thermoprodukts muss nach den speziellen individuellen Ansprüchen getroffen werden, wobei die erforderliche Gesamtwärmeleistung für die Heizanlage und der Installationsstandort genauestens abzuwägen sind.

Productos térmicos

La elección del producto térmico que instalar se realiza según las necesidades específicas individuales, valorando minuciosamente la potencia calorífica total necesaria en la instalación de calefacción y el lugar donde va situada.

camino o stufa da installare. Solo in questo modo è possibile quantificare il calore necessario per riscaldare l'ambiente.

m³ that can be heated
The data is indicative. For the generator to be sized correctly, contact a skilled technician/designer. The total volume to heat, the thermal building insulation grade, the sun exposure and the climatic zone have to be determined in order to make the best choice about the fireplace or stove to install. This is the only way to quantify the environmental needed heat.

m³ chauffables

La donnée est indicative. Pour le dimensionnement correct du générateur, il est nécessaire de s'adresser à un technicien/concepteur agréé. Pour bien choisir la cheminée ou le poêle à installer il est nécessaire de déterminer le volume global à chauffer, le niveau d'isolation du bâtiment, l'exposition au soleil et la zone climatique. Cela permet de calculer la quantité de chaleur nécessaire pour chauffer la pièce.

Beheizbare m³

Es handelt sich um einen Richtwert. Für eine korrekte Bemessung des Wärmeerzeugers sind ein zugelassener Techniker bzw. Planer zu kontaktieren. Für die optimale Wahl des zu installierenden Kaminofens oder Ofens sind das zu beheizende Gesamtvolumen, die Isolation des Gebäudes, dessen Ausrichtung und die Klimazone zu berücksichtigen. Nur so kann die notwendige Wärmemenge für die Beheizung der Räume ermittelt werden.

m³ calefactables

El valor es aproximado. Para un correcto dimensionamiento del generador, es necesario ponerse en contacto con un técnico o un proyectista habilitado. Es necesario determinar el volumen total que debe calentarse, el grado de aislamiento de la construcción, las exposiciones al sol y a que zona climática pertenece para realizar la elección óptima de la chimenea o estufa a instalar. Sólo así puede cuantificarse el calor necesario para calentar el lugar.

égale à deux fois le diamètre du conduit de fumée pour garantir une bonne évacuation des résidus de combustion tout en protégeant des intempéries (ex. vent) ou des corps étrangers.

Schornstein

Befindet sich am Ende des Kamins und muss über den gleichen Innendurchmesser wie der Kamin verfügen; der Austrittsdurchmesser muss doppelt so groß wie der des Rauchabzugsrohrs sein, um den Abzug der Verbrennungsrückstände zu gewährleisten und dabei den Kamin vor Witterungseinflüssen (z. B. Wind) oder Fremdkörpern zu schützen.

Remate de chimenea

Situado en la parte superior de la chimenea debe tener una sección igual a la de ésta, la sección de salida debe ser el doble que el diámetro del humero para garantizar la eliminación de los residuos de combustión protegiendo de los agentes atmosféricos (p.ej. viento) o cuerpos extraños.



5 La Canalizzazione

E' importante sempre valutare le distanze massime canalizzabili del prodotto installato.

Canalization

It is always important to assess the maximum air-ductable distances of the installed product.

Système de gaines

Il est important de déterminer la longueur maximale des gaines en fonction de l'appareil installé.

Verlegung

Es ist immer wichtig, die maximalen Entfernungen, die das installierte Produkt erlaubt, zu überprüfen.

La Canalización

Es importante valorar siempre las distancias máximas canalizables del producto instalado.



7 m³ Riscaldabili

Il dato è indicativo. Per un corretto dimensionamento del generatore è necessario rivolgersi ad un tecnico/progettista abilitato. È necessario determinare il volume complessivo che deve essere riscaldato, il grado di isolamento della costruzione, le esposizioni verso il sole e la zona climatica di appartenenza per la scelta ottimale del

Potenza nominale kW Nominal power kW Puisissance nominale kW Nominalleistung in kW Potencia nominal kW	m ³ riscaldabile m ³ to heat Surface chauffable m ³ Beheizbare m ³ m ³ Calentables
5 - 8	150 - 200 circa
8 - 12	200 - 300 circa
12 - 20	300 - 500 circa

Riferito al fabbisogno di 30 kcal/h x m³
Referred to the need of 30 kcal/h x m³
Par rapport à un besoin de 30 Kcal/h x m³

Bezogen auf einen Bedarf von 30 Kcal/h x m³
Referido a la necesidad de 30 kcal/h x m³

Il Risparmio

Savings / Les Économies / Einsparung / El Ahorro



Risparmio economico e rispetto dell'ambiente: grazie ad apparecchi tecnologicamente performanti, con l'utilizzo di legna e pellet per il riscaldamento domestico può essere risparmiato il 50-60% della spesa per altri combustibili.

Un vantaggio economico che permette anche di contribuire alla salvaguardia del pianeta e del futuro.

Financial savings and respect for the environment... thanks to high-tech appliances, heating your home with wood and pellets can save up to 50-60% of the cost with other fuels.

Benefits which go beyond the merely financial, enabling you to help preserve the planet and the future.



Économies et respect de l'environnement: grâce à des appareils technologiquement performants, l'utilisation de bois et granulés pour le chauffage domestique permet de faire des économies de 50 à 60% par rapport au chauffage avec d'autres combustibles.

Un avantage économique qui permet également de contribuer à préserver la planète pour les générations futures.



Kosteneinsparung und Umweltschutz: Dank leistungsstarker Hightech-Geräte können mit der Verwendung von Holz und Pellets für die Heizung im Privatbereich 50-60 % der Ausgaben für andere Brennstoffe gespart werden.

Ein Kostenvorteil, der auch zum Schutz unseres Planeten und zur Wahrung der Zukunft beiträgt.

Combustibili

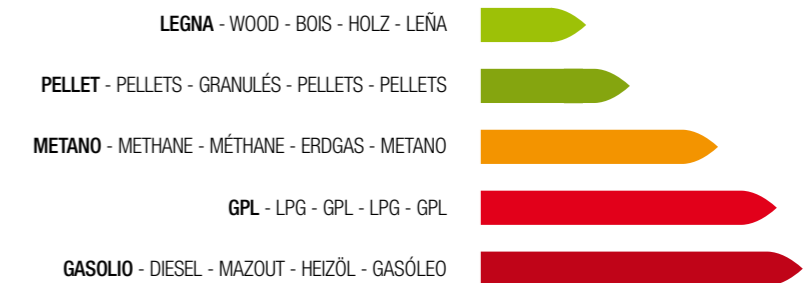

Ahorro económico y respeto del medio ambiente: gracias a aparatos tecnológicamente eficaces, con el uso de leña y pellet para la calefacción doméstica se puede ahorrar el 50-60% de lo que se gasta en otros combustibles.

Una ventaja económica que también permite contribuir a la conservación del planeta y del futuro.

I Materiali

Materials / Les Matériaux / Materialien / Los Materiales

Ghisa. La Nordica-Extraflame da sempre utilizza la migliore Ghisa per la produzione dei propri prodotti.

Grazie all' elevato coefficiente di tensione termica che permette di mantenere inalterate le forme, la ghisa è il materiale perfetto per le stufe: resistente al calore ed urti, idoneo a cedere il calore diffondendolo a lungo nell'ambiente. Inoltre è assolutamente ecologico poiché completamente riciclabile.

Per i prodotti della gamma vengono proposte la finitura smaltata, che garantisce un' estetica con durata illimitata e con minima manutenzione, o verniciata.



Cast iron. La Nordica-Extraflame has always used the best cast iron to make its products.

Thanks to its high thermal stress coefficient, cast iron maintains its shape unaltered, making it the perfect material for stoves... resistant to heat and impact and ideal for releasing the heat with prolonged diffusion in the room.

It is also completely recyclable and therefore environmentally friendly. Products in the range are available either painted or with a long-lasting enamel finish requiring minimal maintenance.

Steel. Special steel is used in La Nordica-Extraflame products to make both thick structural elements and certain braziers where the high temperatures reached necessitate the use of material with high thermal resistance and long life to guarantee top performance.

Acciaio. Per i prodotti La Nordica-Extraflame, viene usato acciaio speciale sia per gli elementi strutturali ad alto spessore, sia per alcuni bracieri dove le alte temperature richiedono un materiale ad altissima resistenza termica e lunga durata per garantire le migliori prestazioni.



Fonte. La Nordica-Extraflame depuis toujours utilise la meilleure fonte pour la production de ses appareils.

Grâce à sa très bonne tenue en fatigue thermique qui permet à la fonte de ne pas se déformer, c'est le matériau idéal pour les poêles: résistant à la chaleur et aux chocs, pouvant transmettre la chaleur en la diffusant lentement dans la pièce.

En outre c'est un matériau totalement écologique car entièrement recyclable. Les appareils de la gamme sont disponibles en finition émaillée pour une qualité esthétique illimitée et un entretien minimal, ou peinte.

Acier. Les éléments structurels haute épaisseur des appareils La Nordica-Extraflame sont construits en acier spécial ainsi que certains brasiers où les hautes températures exigent un matériau à très haute résistance thermique et longue durée pour garantir les meilleures performances.



Gusseisen. Seit jeher verwendet La Nordica-Extraflame das beste Gusseisen zur Herstellung seiner Produkte.

Dank des hohen Wärmespannungskoeffizienten, der die Formbeständigkeit ermöglicht, ist Gusseisen das perfekte Material für die Ofenherstellung: hitze- und stoßfest und geeignet, Wärme abzugeben und diese für lange Zeit im Raum zu verteilen.

Gusseisen ist zudem umweltfreundlich, denn es ist komplett recycelbar.

Für die Produktreihe stehen die Ausführungen emailliert (unbegrenzt beständiges Aussehen und minimaler Wartungsaufwand) oder lackiert zur Verfügung.

Stahl. Für die Produkte La Nordica-Extraflame wird ein Spezialstahl sowohl für die tragenden, sehr massiven Elemente als auch für einige Brenntöpfe verwendet, bei denen hohe Temperaturen den Einsatz eines Werkstoffs mit sehr hoher Hitzebeständigkeit und langer Haltbarkeit erfordern, um optimale Leistungen zu garantieren.

Ghisa. La Nordica-Extraflame usa desde siempre la mejor fundición para la fabricación de sus propios productos.

Gracias al alto coeficiente de tensión térmica que permite mantener inalteradas las formas, la fundición es el material perfecto para las estufas: resistente al calor y a los golpes, idónea para ceder el calor difundiéndolo durante mucho tiempo al ambiente.

Además es absolutamente ecológica ya que es totalmente reciclable.

Para los productos de la gama se proponen el acabado esmaltado, que garantiza una estética de duración ilimitada y con un mantenimiento mínimo, o barnizada.

Acero. Para los productos LaNordica-Extraflame, se usa acero especial tanto para los elementos estructurales de gran grosor, como para algunos braseros en los que las altas temperaturas exigen un material de altísima resistencia térmica y larga duración para garantizar las mejores prestaciones.

I Materiali

Materials / Les Matériaux / Materialien / Los Materiales

Vetro ceramico. Massima qualità e sicurezza sono i vantaggi delle lastre in vetroceramica che spingono La Nordica-Extraflame a continuare a investire nell'uso di questo materiale, ad alta resistenza termica e di estrema durata.

Rispetto al vetro normale il vetroceramico ha un coefficiente di espansione termica pari quasi a zero, così da non deformarsi per effetto del calore e rappresentare un materiale irrinunciabile per tutti i caminetti e stufe, dove trovano applicazione lastre non soltanto piane ma anche angolate, bombate o addirittura tridimensionali ed in varie dimensioni.



Nordiker™. Per la realizzazione dei refrattari La Nordica-Extraflame ha depositato il Nordiker™, un materiale speciale che grazie alla propria resistenza permette di raggiungere elevate temperature di combustione.

Il Nordiker™ offre sicurezza di utilizzo, semplicità nella manutenzione e lunga durata. È inoltre di per sé indicatore di funzionamento, poiché il mantenimento del colore chiaro non solo esalta la luminosità della fiamma ma indica un corretto utilizzo dell'apparecchio.

La scelta di prodotti in Nordiker™ si traduce per il cliente in un migliore funzionamento, grande resa estetica e in minori emissioni.



Glass-ceramics. Glass-ceramic sheets offer top quality and safety, characteristics which have encouraged La Nordica-Extraflame to continue investing in use of this extremely durable material with high thermal resistance.

Compared to normal glass, glass-ceramics have a thermal expansion coefficient of almost zero, they do not therefore distort when heated and represent a fundamental material for all fireplaces and stoves which use not just flat sheets, but also angled, curved or even three-dimensional in various sizes.

Nordiker™. To make its refractory products, La Nordica-Extraflame has patented Nordiker™, a special highly resistant material allowing very high combustion temperatures to be reached.

Nordiker™ is safe to use, easy to maintain and extremely durable. It is also an indication of operation as preservation of the light colour not only shows off the luminosity of the flame to full advantage, but also indicates correct use of the appliance.

For customers, choosing a product made from Nordiker™ means better operation, an attractive appearance and lower emissions.



Verre céramique. Qualité et sécurité maximales sont les avantages des plaques en verre céramique qui poussent La Nordica-Extraflame à continuer à investir dans l'utilisation de ce matériau à très haute résistance thermique et durée extrême.

Par rapport au verre normal le verre céramique a un coefficient de dilation thermique égal à zéro, donc il ne se déforme pas sous l'effet de la chaleur; c'est un matériau idéal pour toutes les cheminées et poêles où les plaques de verre utilisées ne sont pas toujours planes mais irrégulières, bombés ou même tridimensionnelles et de différentes dimensions.

Glaskeramik. Spitzenqualität und Sicherheit sind die Vorteile der Glaskeramikplatten, die La Nordica-Extraflame veranlassen, in die Verwendung dieses Materials mit seiner hohen Hitzebeständigkeit und extrem langen Haltbarkeit zu investieren.

Im Vergleich zu normalem Glas besitzt Glaskeramik einen Wärmeausdehnungskoeffizienten fast gleich null, sodass sie sich durch Hitze nicht verformt und ein unverzichtbares Material für alle Kaminöfen und Öfen darstellt, bei denen nicht nur flache, sondern auch gewölbte Elemente und Eckplatten oder sogar dreidimensionale Elemente in verschiedenen Größen eingesetzt werden.

Nordiker™. Die feuerbeständigen Elemente bestehen aus Nordiker™, einem von La Nordica-Extraflame konzipierten und als Warenzeichen eingetragenen speziellen Material, das dank seiner Beständigkeit hohe Verbrennungstemperaturen ermöglicht.

Nordiker™ bietet sichere Verwendung, einfache Wartung und lange Haltbarkeit. Das Material liefert zudem einen Hinweis auf den Betrieb, denn wenn es hell bleibt, wird nicht nur die Leuchtkraft der Flamme zur Geltung gebracht, sondern auch angezeigt, dass das Gerät sachgemäß benutzt wird.

Produkte aus Nordiker™ gewährleisten bessere Funktionstüchtigkeit, ansprechende Optik und geringere Emissionen.



Cristal cerámico. Máxima calidad y seguridad son las ventajas de las placas de vitrocerámica que empujan La Nordica-Extraflame a seguir invirtiendo en el uso de este material, de alta resistencia térmica y muy larga duración.

Respecto al Cristal normal la vitrocerámica posee un coeficiente de expansión térmica casi igual a cero, lo que hace que no se deforme por efecto del calor y que sea un material ineludible para todas las chimeneas y estufas, en las que hallan aplicación placas no sólo planas sino también angulosas, abombadas o totalmente tridimensionales y en varias dimensiones.

Nordiker™. Para la realización de los refractarios La Nordica-Extraflame ha depositado Nordiker™, un material especial que gracias a su propia resistencia permite alcanzar elevadas temperaturas de combustión.

Nordiker™ ofrece seguridad de uso, sencillez en el mantenimiento y larga duración. Es además un indicador de funcionamiento en sí mismo, puesto que el mantenimiento del color claro no sólo exalta la luminosidad de la llama sino que indica el uso correcto del aparato.

La elección de productos de Nordiker™ supone para el cliente un mejor funcionamiento, un gran rendimiento estético y menos emisiones.

Nordiker™. Pour la réalisation des parties réfractaires La Nordica-Extraflame a breveté l'Nordiker™, un matériau spécial qui grâce à sa résistance permet d'atteindre des températures de combustion élevées.

L'Nordiker™ offre sécurité d'utilisation, simplicité d'entretien et longévité. Sa couleur claire intensifie la luminosité de la flamme et indique aussi le bon fonctionnement de l'appareil si elle ne se modifie pas.

Le choix de produits en Nordiker™ se traduit pour le client en un meilleur fonctionnement, un excellent rendu esthétique et de faibles émissions polluantes.



La Maiolica

Qualità dei materiali
significa affidabilità e durata

Majolica

High quality materials mean
reliability and a long working life

La Faïence

Qualité des matériaux
signifie fiabilité et longévité.

Majolika-Kacheln

Qualitativ hochwertige Materialien
garantieren Zuverlässigkeit und Haltbarkeit.

La Mayólica

Calidad de los materiales
significa fiabilidad y duración



La Maiolica

2 settimane di lavorazione. La Nordica-Extrafame, nella costante ricerca della migliore qualità, ha scelto per i suoi prodotti il rivestimento in maiolica che garantisce un ottimo accumulo di calore, ceduto nell'ambiente con continuità e uniformità. La maiolica è il risultato di una lavorazione artigianale di altissima qualità. Il lungo ciclo di lavorazione (due settimane) necessario per ottenere una maiolica, pur avvalendosi dei più nuovi supporti tecnologici a garanzia di una qualità totale, deve essere eseguito completamente a mano. Il risultato è che ogni maiolica è un pezzo bellissimo, unico e irripetibile e le particolarità che si potranno riscontrare su ogni singola maiolica quali cavillature, punteggiature e ombreggiature ne sono la garanzia.

Majolica

2 weeks production. In its constant quest to improve quality, La Nordica-Extrafame has chosen to face its products with majolica to guarantee optimum storage of the heat which is then given off evenly to the room. Majolica is the result of a top quality hand production process. Although it uses the most up-to-date technology to guarantee total quality, the lengthy production cycle (two weeks) required to obtain majolica, must be performed completely by hand. All majolica is therefore beautiful, unique and unrepeatable, as guaranteed by the details you can observe on each individual piece, such as craquelure, speckling and shading.

La Faïence

2 semaines de travail. La Nordica-Extrafame dans sa recherche constante de la meilleure qualité, a choisi pour ses produits le revêtement en faïence qui garantit une accumulation optimale de la chaleur et une diffusion uniforme et continue de celle-ci. La faïence est le résultat d'un travail artisanal de très haute qualité. Le cycle de fabrication assez long (deux semaines), bien que réalisé à l'aide des procédés technologiques les plus récents pour garantir une qualité totale, doit être exécuté entièrement à la main. Le résultat est que chaque faïence est une pièce unique et magnifique, et les craquelures, l'aspect grenelé ou ombré que présente la faïence en sont la garantie.

Die Majolika-Kachel

Eine Verarbeitungszeit von 2 Wochen. Die Majolika-Kachel ist das Ergebnis einer handwerklichen Arbeit von höchster Qualität. Der lange Verarbeitungszyklus (zwei Wochen), der für die Herstellung einer Majolika erforderlich ist, obwohl die neuesten technologischen Hilfsmittel für die Gewährleistung der vollständigen Qualität eingesetzt werden, muss komplett von Hand ausgeführt werden. Das Resultat ist, dass jede Majolika ein wunderschönes, einzigartiges und nicht wiederholbares Einzelstück darstellt. Die Besonderheiten, durch die sich jede einzelne Majolika auszeichnet, wie Haarlinsen, Punktierungen und Schatten, sind die Garantie dafür.

La Mayólica

2 semanas de elaboración. La Nordica-Extrafame, en la búsqueda permanente de la mejor calidad, ha elegido para sus productos el revestimiento de mayólica que garantiza una excelente acumulación de calor, cedido al ambiente de forma continua y uniforme. La mayólica es el resultado de una elaboración artesanal de altísima calidad. El ciclo de elaboración extenso (dos semanas) necesario para lograr una mayólica realizada a mano que, si bien recurre a nuevos soportes tecnológicos, garantiza una calidad absoluta. El resultado es que hoy la mayólica es una pieza hermosa, exclusiva e irrepitible y con características que se podrán encontrar en cada pieza de mayólica como grietas, punteados y sombreados que representan su la garantía.



Produzione: le linee

Production: the lines / Production: les lignes / Produktlinien / Producción: las líneas

La produzione si svolge completamente all'interno degli stabilimenti del Gruppo, dove investimenti ingenti permettono di lavorare con impianti nuovi e tecnologicamente avanzati. La produzione industriale può contare sull'attenzione e professionalità, dalle fasi di stampaggio, piegatura, taglio fino all'assemblaggio dei semilavorati svolto in evolute ed innovative linee di montaggio.



All production takes place in the Group's factories where substantial investments enable the company to operate with new technologically advanced equipment. Production is backed by attention and professionalism, from moulding, bending and cutting to assembly of the semi-finished elements performed on highly advanced innovative assembly lines.



La production a lieu entièrement dans les usines du Groupe, où des investissements importants permettent de travailler avec des installations modernes et à la pointe de la technologie. La production industrielle peut compter sur le soin et le professionnalisme du personnel, des phases d'estampage, pliage, découpe jusqu'à l'assemblage des demi-produits sur des lignes de montage évoluées et innovantes.



Die Fertigung erfolgt ausschließlich in den konzerneigenen Werken, wo beträchtliche Investitionen die Arbeit mit neuen Hightech-Anlagen ermöglichen.

Bei der industriellen Fertigung wird großer Wert auf Sorgfalt und Professionalität gelegt: vom Umformen über das Biegen und Schneiden bis zum Zusammenbau der Halbfertigteile auf innovativen Hightech-Montageanlagen.

La producción se desarrolla completamente en las fábricas del Grupo, donde ingentes inversiones permiten trabajar con instalaciones nuevas y tecnológicamente avanzadas. La producción industrial puede contar con la atención y profesionalidad desde las fases de impresión, doblado, corte fino hasta el montaje de los semilaborados que se realiza en unas líneas de montaje evolucionadas e innovadoras.

Le famiglie di prodotti La Nordica-Extraflame

Product families

Stufe a legna e pellet,
Caminetti e Inserti a legna e pellet,
Cucine a legna,
Termoprodotti a legna e pellet,
Caldaie a legna e pellet,
Solare termico.

Wood and pellet stoves
Wood and pellet fireplaces
Wood burning cookers
Wood and pellet thermo products
Wood and pellet boilers
Thermic solar system

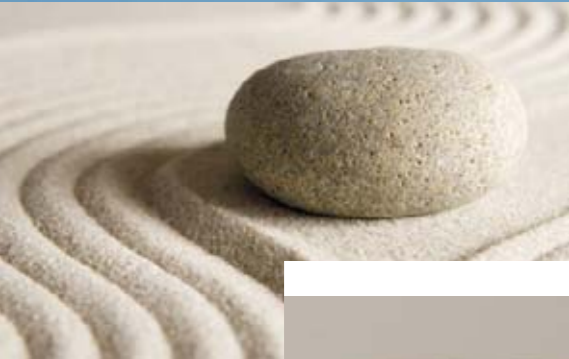
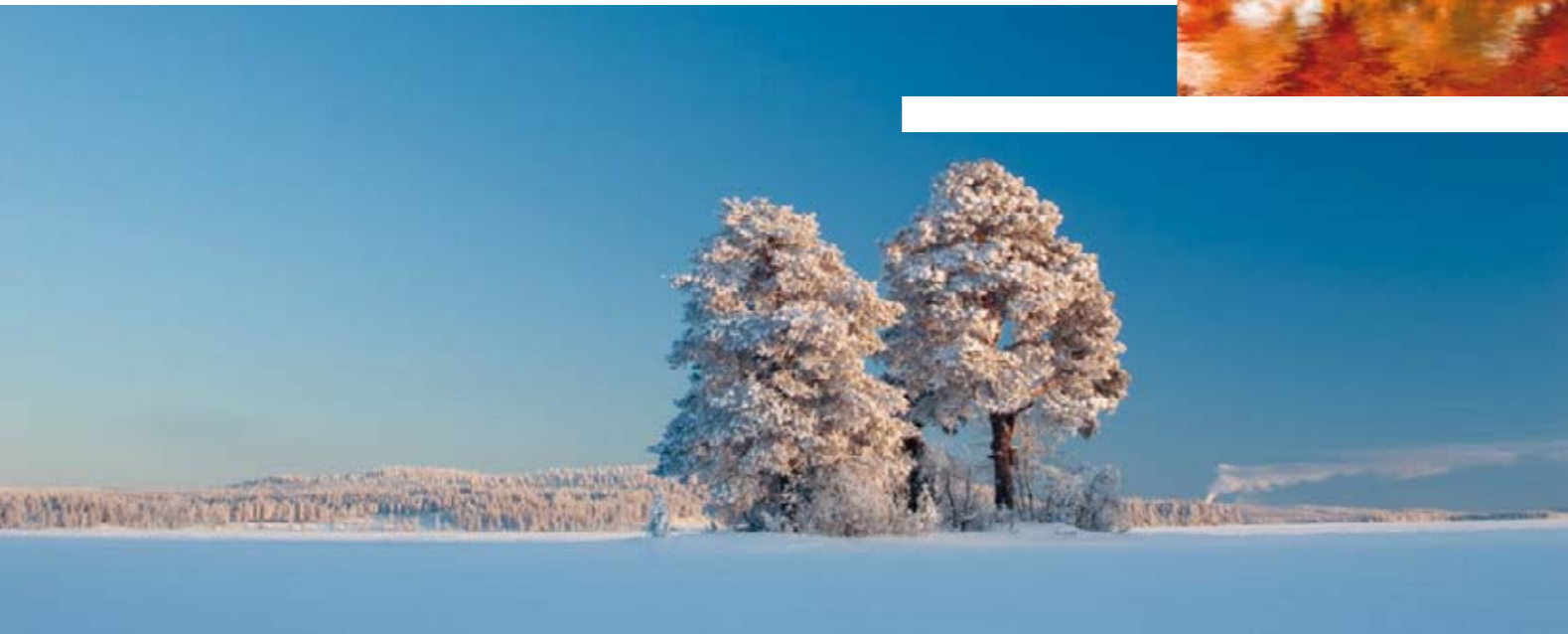

SERIE COMBIMATE

Raffinata nel design,
silenziosa e all'avanguardia
nella tecnologia:
Cleo Combi, con la doppia
alimentazione a legna e
pellet, assicura alla vostra
casa un piacevole tepore
per molte ore
ed in piena autonomia.



DUAL-FUEL
SERIES:
Refined design,
silent and high
technology, the
wood and pellet
dual fuelled Cleo
Combi
guarantees hours
of warmth in the
home with full
autonomy.

SÉRIE POÊLES
COMBINÉS:
Design raffiné,
technologie
d'avant-garde,
silencieux, le
cleo combi,
avec sa double
alimentation
bois et granulés
bois, produit
une chaleur
agréable
pendant
plusieurs
heures et en
toute autonomie.

KOMBINIERTE
SERIEN:
Raffiniertes
Design, leise
und
fortschrittliche
Technologie: der
Cleo Combi mit
seiner doppelten
Brennstoffversor-
gung mit Holz
oder Pellets
erfüllt Ihr Haus
in vollkommener
Unabhängigkeit
für viele Stunden
mit angenehmer
Wärme.

SERIES
COMBINADAS:
De diseño
refinado,
silenciosa y
proyectada con
tecnología de
vanguardia,
cleo combi, con
doble
alimentación a
leña y pellet,
crea en la casa
una agradable
tibieza que se
prolonga por
muchas horas
con absoluta
autonomía.



Cleo Combi Vogue*

Serie **Combinata**



Ametista



Stufa a tiraggio naturale con funzionamento a legna o pellet. Rivestimento esterno in maiolica decorata a mano. Rivestimento interno del focolare in Nordiker™ con post combustione. Cassetto cenere estraibile. Vetro ceramico resistente fino a 750°.

Natural draught stove operating with wood or pellet. Hand enameled, majolica facing. Internal facing of the hearth in Nordiker™ with post combustion. Extractable ash drawer. Ceramic glass resistant up to 750°.

Poêle à tirage naturelle avec fonctionnement à bois ou pellet. Revêtement en majolique décoré à main. Revêtement intérieur du foyer en Nordiker™ avec post combustion. Tiroir cendrier amovible. Vitre céramique résistante à 750°.

Kombinationskaminofen mit natürlichem Schornsteinzug. Verkleidung aus Majolika mit handwerklichen Dekor. Innenbekleidung des Feuerraums aus Nordiker™ mit Doppelverbrennung. Herausziehbare Aschenlade. Keramikglas bis 750° wärmebeständig.

Estufa a tiro natural con funcionamiento en madera o pellet. Revestimiento de mayolica, decoración a mano. Revestimiento interior del hogar de Nordiker™ con post combustión. Cajón de cenizas extraíble. Crystal cerámico resistente a 750°.



CLEO COMBI VOGUE

679x1335x664

235 kg

340x210

345x270x175

AM*

150 sup

Nordiker™

legna 183 - pellet 172

legna 8,1 - pellet 7,4 kW-M

legna 6,4 - pellet 6 kW-N

Si air-1

Si air-2

Si air-3

legna 79,2 - pellet 81 %

legna 1,8 - pellet 1,5

pellet ~20

Ø 150

CLEO COMBI

641x1335x637

216 kg

340x210

345x270x175

BO*

150 sup

Nordiker™

legna 183 - pellet 172

kW-M legna 8,1 - pellet 7,4

kW-N legna 6,4 - pellet 6

air-1 Si

air-2 Si

air-3 Si

% legna 79,2 - pellet 81

legna 1,8 - pellet 1,5

pellet ~20

Ø 150



Cleo Combi Bordeaux



SERIE TOP MAIOLICA

Maioliche con raffinati decori, racchiudono un focolare ad alto rendimento per una calda atmosfera in ogni casa.

MAJOLICA TOP SERIES:
Majolica with refined patterns encloses a high efficiency hearth for warmth in every home.

SÉRIE TOP FAÏENCE:
Des faïences au décor raffiné habillent un foyer haut rendement pour une chaude atmosphère dans toute la maison.

SERIE TOP MAJOLIKA:
Majolika-kacheln mit raffinierten Dekors umhüllen eine leistungsfähige Feuerstelle für eine warme Atmosphäre in jedem Haus.

SERIE TOP MAIOLICA:
Mayólicas con refinadas decoraciones encierran un hogar con un elevado rendimiento para crear una atmósfera cálida en cada casa.





850x1478x850

308

335x245

288x320x360

SAM*

130 sup

Ghisa-Nordiker™

229

kW-M 10,2

kW-N 8

air-1 Si

air-2 Si

air-3 Si

% 78,5

2,3

Rivestimento esterno in maiolica decorata a mano.
Rivestimento interno del focolare in ghisa-Nordiker™ con post combustione.
Apertura porta dx-sx.
Cassetto cenere estraibile.
Vetro ceramico resistente fino a 750°.

Hand enameled, majolica facing.
Internal facing of the hearth in cast iron and Nordiker™ with post combustion.
Right/left door opening.
Extractable ash drawer.
Ceramic glass resistant up to 750°.

Revêtement en maiolique décoré à main.
Revêtement intérieur du foyer en fonte/ Nordiker™ avec post combustion.
Ouverture porte droite-gauche.
Tiroir cendrier amovible.
Vitre céramique résistante à 750°.

Verkleidung aus Majolika mit handwerklichen Dekor.
Innenbekleidung des Feuerraums aus Gusseisen-Nordiker™ mit Doppelverbrennung.
Rechte/linke Öffnungstür.
Herausziehbare Aschenlade.
Keramikglas bis 750° wärmebeständig.

Revestimiento de mayolica, decoración a mano.
Revestimiento interior del hogar de fundición y Nordiker™ con post combustión.
Apertura de puerta derecha/izquierda.
Cajón de cenizas extraíble.
Crystal cerámico resistente a 750°.





Bianco Infinity



↓ 800x1620x640

kg 260

335x460

300x500x360

BIN*

150 sup

Ghisa-Nordiker™

m² 229

kW-M 10,2

kW-N 8

air-1 Si

air-2 Si

air-3 Si

% 78,5

2,3

Rivestimento esterno in maiolica.
Rivestimento interno del focolare in ghisa-Nordiker™ con post combustione.
Apertura porta dx-sx.
Cassetto cenere estraibile.
Focolare a fiamma verticale.
Vetro ceramico resistente fino a 750°.

External facing in majolica.
Internal facing of the hearth in cast iron and Nordiker™ with post combustion.
Right/left door opening.
Extractable ash drawer.
Vertical flame hearth.
Ceramic glass resistant up to 750°.

Revêtement extérieur en faïence.
Revêtement intérieur du foyer en fonte/Nordiker™ avec post combustion.
Ouverture porte droite-gauche.
Tiroir cendrier amovible.
Foyer à flamme verticale.
Vitre céramique résistante à 750°.

Äußere Verkleidung aus Majolika.
Innenbekleidung des Feuerraums aus Gusseisen-Nordiker™ mit Doppelverbrennung.
Rechte/linke Öffnungstür.
Herausziehbare Aschenlade.
Feuerstätte mit senkrechter Flamme.
Keramikglas bis 750° wärmebeständig.

Revestimiento exterior de mayólica.
Revestimiento interior del hogar de fundición y Nordiker™ con post combustión.
Apertura de puerta derecha/izquierda.
Cajón de cenizas extraíble.
Hogar con llama vertical.
Crystal cerámico resistente a 750°.



SERIE SLIM

Plasma e Doris, con un design moderno ed il grande focolare protetto da vetro panoramico, permettono di ammirare in sicurezza il fuoco ed i suoi giochi.



SLIM SERIES:
Plasma and Doris with their modern design and large hearth protected by a glass viewing window let you admire the crackling fire in complete safety.

SÉRIE SLIM:
Plasma et Doris au design moderne et le grand foyer protégé par une vitre panoramique permettent d'admirer en toute sécurité le jeu des flammes.

SERIE SLIM:
Mit Plasma und Doris, ihrem modernen Design und der großen Feuerstelle mit Panoramafenster, können Sie in absoluter Sicherheit das Feuer und sein Spiel bewundern.

SERIE SLIM:
Plasma y Doris con un diseño moderno y el gran hogar protegido por cristal panorámico que permite gozar con seguridad de los movimientos del fuego.



Plasma 80:26

Serie **Slim**



Plasma 80:26
Cornice Origami Bianco Infinity



Cornice Argento Antico



Cornice Oro Craquelé



Cornice Madreperla

Profondità 26 cm.
Cassetto cenere estraibile.
Focolare in ghisa-Nordiker™.
Vetro ceramico resistente fino a 750°.
Apertura porta dx-sx.
Comprensivo di carter di adattamento estetico.

26 cm depth.
Extractable ash drawer.
hearth in cast-iron and Nordiker™.
Ceramic glass resistant up to 750°.
Right/left door opening.
Inclusive of aesthetically designed casing.

Profondeur 26 cm.
Tiroir cendrier amovible.
Foyer en fonte Nordiker™.
Vitre céramique résistante à 750°.
Ouverture porte droite-gauche.
Y compris le carter pour l'adaptation esthétique.

26 cm tief.
Herausziehbare Aschenlade.
Feuerstelle aus Nordiker™-Gusseisen.
Keramikglas bis 750° wärmebeständig.
Rechte/linke Öffnungstür.
Attraktives Gehäuse inbegriffen.

Profundidad 26 cm.
Cajón de cenizas extraíble.
Hogar de fundición- Nordiker™.
Crystal cerámico resistente a 750°.
Apertura de puerta derecha/izquierda.
Equipado con cárter para adaptación estética.

26 cm



Cornice Crystal



Cornice Wendy

800x555x310*

112

635x185

590x266x130

Cornice arg. antico
Cornice oro craquelé
Cornice madreperla
Cornice Crystal
Cornice Wendy
Cornice Origami

130 sup

Ghisa-Nordiker™ air-1 Si

172 air-2 Si

kW-M 7,7 % 78,4

kW-N 6,0 1,8



* Kit cornici escluso
* Excluding surround kit
* Kit cadres exclus
* Rahmenset nicht inbegriffen
* Kit marcos no incluido



Doris profondità 30 cm.
Rivestimento in maiolica lavorata a mano.
Cassetto cenere estraibile.
Focolare in Ghisa-Nordiker™.
Vetro ceramico resistente fino a 750°.
Apertura porta dx-sx

Doris 30 cm depth.
Hand enameled majolica facing.
Extractable ash drawer.
Nordiker™ hearth.
Ceramic glass resistant up to 750°.
Right/left door opening.

Doris profondeur 30 cm.
Revêtement extérieur en maiolique décorée à main.
Tiroir cendrier amovible.
Foyer en Nordiker™.
Vitre céramique résistante à 750°.
Ouverture porte droite-gauche.

Doris 30 cm tief.
Verkleidung aus handgefertigter Majolika.
Herausziehbare Aschenlade.
Feuerraumsverkleidung aus Nordiker™.
Keramikglas bis zum 750° wärmebeständig.
Rechte/linke Öffnungstür.

Doris profundidad 30 cm.
Revestimiento de mayólica hecho a mano.
Cajón de cenizas extraíble.
Hogar de Nordiker™.
Crystal cerámico resistente a 750°.
Apertura de puerta derecha/izquierda.



	580x1280x356		BIN*	kW-M	7,3	air-3	Si
	141		130 sup	kW-N	6,0	%	82
	330x340		Ghisa-Nordiker™	air-1	Si		1,7
	304x502x162		172	air-2	Si		Ø 120



Doris Silk Vogue Ametista*

Serie **Slim**



Silk Vogue Ametista



Profondità 30 cm.
Rivestimento in maiolica.
Cassetto cenere estraibile.
Focolare in ghisa-Nordiker™.
Vetro ceramico resistente fino a 750°.
Apertura porta dx-sx.

30 cm depth.
External facing in majolica.
Extractable ash drawer.
Hearth in cast-iron and Nordiker™.
Ceramic glass resistant up to 750°.
Right/left door opening.

Profondeur 30 cm.
Revêtement extérieur en faïence.
Tiroir cendrier amovible.
Foyer en fonte Nordiker™.
Vitre céramique résistante à 750°.
Ouverture porte droite-gauche.

30 cm tief.
Äußere Verkleidung aus Majolika.
Herausziehbare Aschenlade.
Attraktives Gehäuse inbegriffen.
Keramikglas bis 750°
wärmebeständig.
Rechte/linke Öffnungstür.

Profundidad 30 cm.
Revestimiento de mayolica,
decoración a mano.
Cajón de cenizas extraíble.
Hogar de fundición - Nordiker™.
Crystal cerámico resistente a 750°.
Apertura de puerta derecha/izquierda.

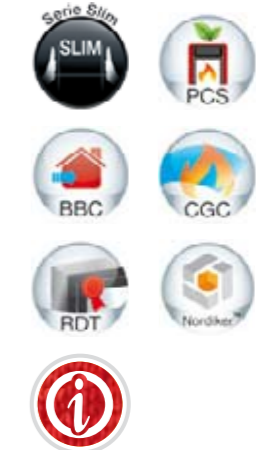

	680x1298x356
	147
	330x340
	304x502x162
	SAM*
	130 sup
	Ghisa-Nordiker™
	172
	7,3
	6,0
	Si
	Si
	Si
	82
	1,7
	Ø 120

SERIE STUFE-CAMINO

Le maioliche che rivestono il caminetto creano un nuovo oggetto d'architettura, per rendere unica la vostra casa.



FLUE STOVE SERIES:
The majolica faced flue stove turns the stove into a new interior design accessory to make your home unique.

SÉRIE POÊLES CHEMINÉE:
Les faïences de la cheminée créent un nouvel objet d'architecture pour un intérieur unique.

SERIE KAMINÖFEN:
Die Majolika-Kacheln des Kaminofens kreieren ein neues Architekturelement und machen Ihr Haus zum einzigartigen Objekt.

SERIE ESTUFASO CHIMENEA:
Las mayólicas que revisten la chimenea crean un nuevo objeto de arquitectura dando exclusividad a vuestra casa.





Cassetto cenere estraibile.
Focolare in ghisa-Nordiker™.
Vetro ceramico resistente fino a 750°.
Rivestimento in maiolica.
Apertura porta dx-sx.

Extractable ash drawer.
Hearth in cast-iron and Nordiker™.
Ceramic glass resistant up to 750°.
External facing in majolica.
Right/left door opening.

Tiroir cendrier amovible.
Foyer en fonte Nordiker™.
Vitre céramique résistante à 750°.
Revêtement extérieur en faïence.
Ouverture porte droite-gauche.

Herausziehbare Aschenlade.
Attraktives Gehäuse inbegriffen.
Keramikglas bis 750°
wärmebeständig.
Äußere Verkleidung aus Majolika.
Rechte/linke Öffnungstür.

Cajón de cenizas extraíble.
Hogar de fundición - Nordiker™.
Crystal cerámico resistente a 750°.
Revestimiento exterior de mayólica.
Apertura de puerta derecha/izquierda.

880x633x580

188

635x245

600x315x360

BIN*

160 s/p

Ghisa-Nordiker™

244

kW-M 7,3

kW-N 8,5

air-1 Si

air-2 Si

air-3 Si

% 78,5

2,5

Ø 120



Fly con supporto*

Serie **Stufe-Camino**



Bianco Infinity



Nero Lucido



Cassetto cenere estraibile.
Focolare in ghisa-Nordiker™.
Vetro ceramico resistente fino a 750°.
Rivestimento in maiolica.
Apertura porta dx-sx.









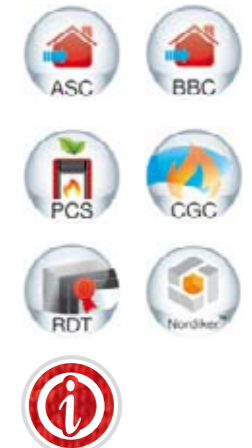







Extractable ash drawer.
Hearth in cast-iron and Nordiker™.
Ceramic glass resistant up to 750°.
External facing in majolica.
Right/left door opening.

Tiroir cendrier amovible.
Foyer en fonte Nordiker™.
Vitre céramique résistante à 750°.
Revêtement extérieur en faïence.
Ouverture porte droite-gauche.

Herausziehbare Aschenlade.
Feuerstelle aus Nordiker™-Gusseisen.
Keramikglas bis 750° wärmebeständig.
Äußere Verkleidung aus Majolika.
Rechte/linker Öffnungstür.

Cajón de cenizas extraíble.
Hogar de fundición - Nordiker™.
Crystal cerámico resistente a 750°.
Revestimiento exterior de mayólica.
Apertura de puerta derecha/izquierda.



-  880x955x565
-  199
-  635x245
-  600x315x360
-  BIN*-NEL*
-  160 s/p
-  Ghisa-Nordiker™
-  244
-  kW-M 10,8
-  kW-N 8,5
-  air-1 Si
-  air-2 Si
-  air-3 Si
-  % 78,5
-  2,5
-  Ø 120

Falò 1C*

Serie **Stufe-Camino**



1C Giallo Panca Sabbia



Rosone copriforno - Optional

Forno smaltato estraibile.
Focolare in Nordiker™ con post
combustione.
Vano portalegna.
Rivestimento esterno in maiolica.
Panca in maiolica.
Vetro ceramico resistente fino a 750°.

Four émaillé amovible.
Foyer en Nordiker™ avec post
combustion.
Bac à bois.
Revêtement extérieur en faïence.
Banquette en faïence.
Vitre céramique résistante à 750°.

Horno esmaltado extraíble.
Hogar en Nordiker™ con post
combustión.
Vano portaleña.
Revestimiento exterior de mayólica.
Base de mayólica.
Crystal cerámico resistente a 750°.

Extractable enameled oven.
Hearth in Nordiker™ with post
combustion.
Wood-holder.
External facing in majolica.
Majolica bench.
Ceramic glass resistant up to 750°.

Herausziehbarer-und emailierter
Backfach.
Feuerraums aus Nordiker™ mit
Doppelverbrennung.
Holzfach.
Äußere Verkleidung aus Majolika.
Bank aus Majolika.
Keramikglas bis 750° wärmebeständig.

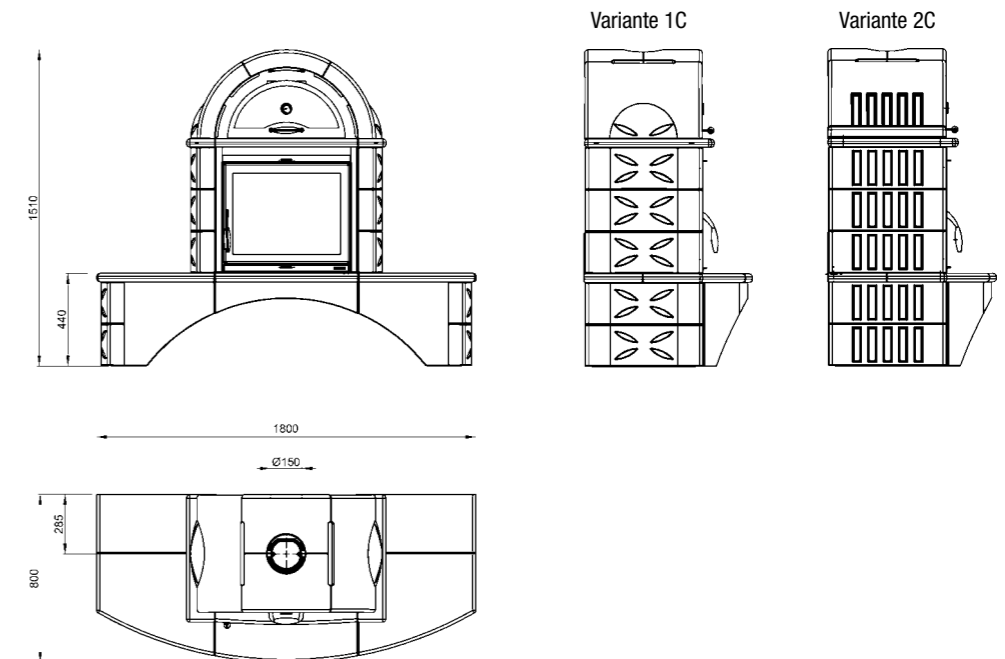

1800x1510x800

417

520x280

590x400x340

500x250x470

Mod. 1C
GI panca SB*
SB panca SB*
SB panca SL*

Mod. 2C
SB panca SB*
SB panca SL*

150 sup

Nordiker™ air-2 Si

258 % 81

kW-M 11,1 2,6

kW-N 9 Optional

air-1 Si



Falò 2C



Falò 2C Sabbia Panca Salmone



Falò 2C



Falò 2C



Forno smaltato estraibile.
Focolare in Nordiker™ con post combustione.
Vano portalegna.
Rivestimento esterno in maiolica.
Vetro ceramico resistente fino a 750°.

Extractable enameled oven.
Hearth in Nordiker™ with post combustion.
Wood-holder.
External facing in majolica.
Ceramic glass resistant up to 750°.



Four émaillé amovible.
Foyer en Nordiker™ avec post combustion.
Bac à bois.
Revêtement extérieur en faïence.
Vitre céramique résistante à 750°.

Herausziehbarer-und emailierter Backfach.
Feuerraums aus Nordiker™ mit Doppelverbrennung.
Holzfach.
Äußere Verkleidung aus Majolika.
Keramikglas bis 750° wärmebeständig.



Horno esmaltado extraíble.
Hogar en Nordiker™ con post combustión.
Vano portaleña.
Revestimiento exterior de mayólica.
Crystal cerámico resistente a 750°.



1XL Sabbia - Turchese

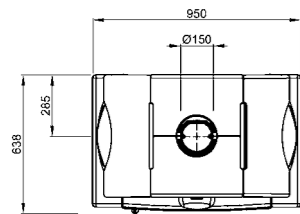
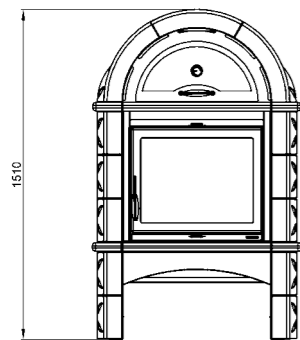

Variante 1XL

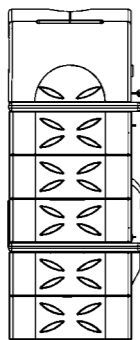

Variante 2XL

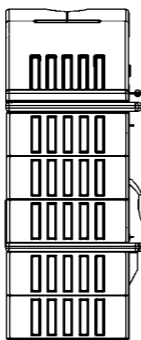

2XL Sabbia - Profili Salmone



	950x1510x638		Mod. 1XL		150 sup	air-1	Si
	358		SB profili SL*		Nordiker™	air-2	Si
	520x280		SB profili TU*		258	%	81
	590x400x340		GI profili SB*		kW-M	11,1	2,6
	500x250x470		Mod. 2XL		kW-N	9	Optional
			SB profili SB*				
			SB profili SL*				
			B0*				

	258	%	81
	kW-M	11,1	2,6
	kW-N	9	Optional



Falò 2L*

Serie **Stufe-Camino**



2L Bordeaux



Forno smaltato estraibile.
Focolare in Nordiker™ con post
combustione.
Vano portalegna.
Rivestimento esterno in maiolica.
Panca in legno.
Vetro ceramico resistente fino a 750°.

Extractable enameled oven.
Hearth in Nordiker™ with post
combustion.
Wood-holder.
external facing in majolica.
Wooden bench.
Ceramic glass resistant up to 750°.

Four émaillé amovible.
Foyer en Nordiker™ avec post
combustion.
Bac à bois.
Revêtement extérieur en faïence.
Banquette en bois.
Vitre céramique résistante à 750°.

Herausziehbarer-und emaillierter
Backfach.
Feuerraums aus Nordiker™ mit
Doppelverbrennung.
Holzfach.
Äußere Verkleidung aus Majolika.
Holzbank.
Keramikglas bis 750° wärmebeständig.

Horno esmaltado extraíble.
Hogar en Nordiker™ con post
combustión.
Vano portaleña.
Revestimiento exterior de mayólica.
Base de madera.
Crystal cerámico resistente a 750°.

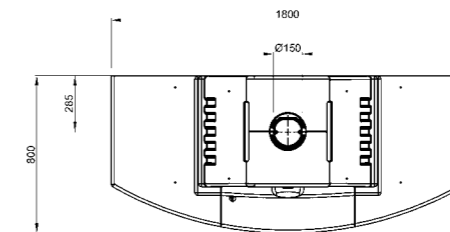
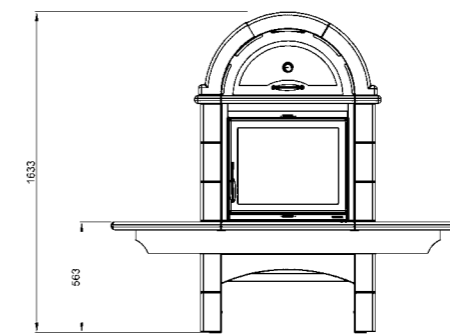

Variante 2L

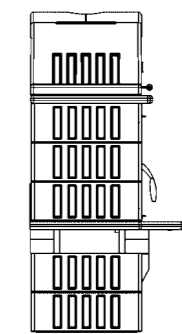

Variante 1L

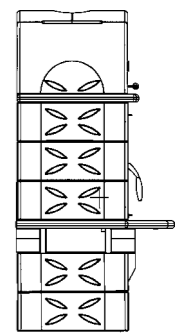

1800x1633x800

399

520x280

590x400x340

500x250x470

Mod. 2L
BO*
SB*

Mod. 1L
SB*
GI profili SB*

150 sup

Nordiker™

258

kW-M 11,1

kW-N 9

air-1 Si

air-2 Si

% 81

2,6

Optional





Forno smaltato estraibile.
Focolare in Nordiker™ con post
combustione.
Rivestimento esterno in maiolica.
Supporto in acciaio verniciato nero.
Vetro ceramico resistente fino a 750°.

Four émaillé amovible.
Foyer en Nordiker™ avec post
combustion.
Revêtement extérieur en faïence.
Support en acier verni noir.
Vitre céramique résistante à 750°.

Horno esmaltado extraíble.
Hogar en Nordiker™ con post
combustión.
Revestimiento exterior de mayólica.
Apoyo de acero barnizado negro.
Crystal cerámico resistente a 750°.

Extractable enameled oven.
Hearth in Nordiker™ with post
combustion.
External facing in majolica.
Holder in dark painted steel.
Ceramic glass resistant up to 750°.

Herausziehbarer-und emailierter
Backfach.
Feuerraums aus Nordiker™ mit
Doppelverbrennung.
Äußere Verkleidung aus Majolika.
Stütze aus schwarzem lackiertem
Stahl.
Keramikglas bis 750° wärmebeständig.

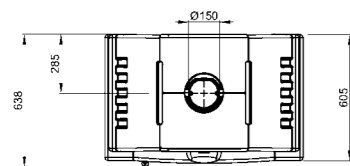
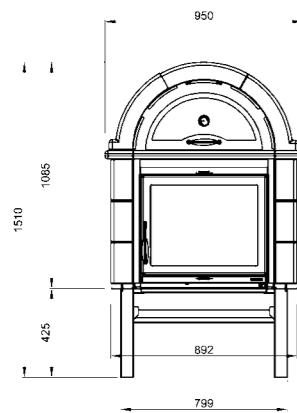

Variante 2S

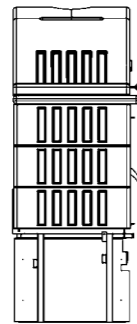

Variante 1S

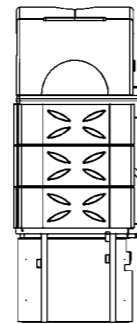

1S Giallo cornice Sabbia



- 950x1510x638
- 331 kg
- 520x280
- 590x400x340
- 500x250x470

- Mod. 2S
BO*
SB cornice SL*
SB cornice SB*
- Mod. 1S
SB cornice SB*
GI cornice SB*
SB cornice SL*

- 150 sup
- Nordiker™
- 258
- 11,1 kW-M
- 9 kW-N
- air-1 SI
- air-2 SI
- 81 %
- 2,6
- Optional





SERIE TOP DESIGN

La resistenza dell'acciaio,
le raffinate maioliche
ed il grande focolare si
completano con un design
moderno ed accattivante.



DESIGN TOP
SERIES:
The resistance
of steel, the
refined majolica
and the large
hearth are
completed by a
modern
attractive
design.

SÉRIE TOP
DESIGN:
La résistance
de l'acier, les
faïences
raffinées et le
grand foyer
s'allient à un
design moderne
et élégant.

SERIE TOP
DESIGN:
Die
Widerstandsfähig-
keit des Stahls,
die raffinierten
Majolika-Kacheln
und die große
Feuerstelle
werden durch
modernes und
beeindruckendes
Design
abgerundet.

SERIE TOP
DESIGN:
La resistencia
del acero, las
refinadas
mayólicas y el
gran hogar se
completan con
un diseño
moderno y
cautivante.





Testata in pietra naturale di grosso spessore
 Cassetto cenere estraibile
 Focolare in ghisa e Nordiker™
 Vetri ceramici resistenti fino a 750°
 Porta in ghisa
 Porta di carico laterale
 Visione frontale e laterale del fuoco
 Il prodotto può essere trasformato con il lato vetro a destra in modo semplice durante la fase di installazione.

Top in natural thick stone
 Extractable ash drawer
 Hearth in cast-iron and Nordiker™
 Ceramic glass heat-resistant 750°C
 Door in cast iron
 Side loading door
 Front and side view of the fire
 The product can be transformed by simply placing the glass side on the right during the installation phase.

Obere Platte aus starkem Naturstein
 Herausziehbare Aschenlade
 Feuerstelle aus Gusseisen und Nordiker™
 Keramikgläser, hitzebeständig bis auf 750°
 Tür aus Gusseisen
 Seitliche Beschickungstür
 Vordere und seitliche Ansicht des Feuers
 Das Produkt kann während der Installation auf einfache Weise umgestaltet werden, wodurch das Glas sich rechts befindet.

Cabecera de piedra natural de espesor grueso
 Cajón de cenizas extraíble
 Hogar de hierro fundido e Nordiker™
 Cristal cerámico resistente hasta los 750°C
 Puerta de hierro fundido
 Puerta de carga lateral
 Vista frontal y lateral del fuego
 El producto puede ser transformado con el lado de cristal a la derecha de manera simple, durante la fase de instalación.

Tête en pierre naturelle de grosse épaisseur
 Tiroir cendrier amovible
 Foyer en fonte et Nordiker™
 Vitres céramiques résistant jusqu'à 750°
 Porte en fonte
 Porte de chargement latéral
 Vision frontale et latérale du feu
 Le produit peut être transformé avec le côté vitre à droite simplement durant la phase d'installation.

758x984x550

214

540x224

605x290x360

PT

160 sup

Ghisa/Nordiker™

264

kW-M 11,8

kW-N 9,2

air-1 Si

air-2 Si

air-3 Si

% 78

2,7

Ø 120





Bianco Infinity



Rivestimento esterno in maiolica
Cassetto cenere estraibile
Rivestimento interno del focolare
in ghisa-Nordiker™ con post
combustione
Porta e griglia in ghisa
Focolare a fiamma verticale
Ventilazione ambiente

External facing in majolica
Extractable ash drawer
Internal facing of the hearth in
cast iron and Nordiker™ with post
combustion
Door and grille in cast iron
Vertical flame hearth
Room ventilation

Revêtement extérieur en faïence
Tiroir cendrier amovible
Revêtement intérieur du foyer
en fonte/Nordiker™ avec post
combustion.
Porte et grille en fonte
Foyer à flamme verticale
Ventilation ambiante

Äußere Verkleidung aus Majolika
Herausziehbare Aschenlade
Innenbekleidung des Feuerraums
aus Gusseisen-Nordiker™ mit
Doppelverbrennung
Tür und Rost aus Gusseisen
Feuerstätte mit senkrechter
Flamme
Raumlüftung

Revestimiento exterior de mayólica
Cajón de cenizas extraíble
Revestimiento interior del hogar de
fundición y Nordiker™ con post
combustión
Puerta y rejilla de hierro fundido
Hogar con llama vertical
Ventilación ambiente



	678x1200x560
	194
	326x347
	300x400x360
	BIN
	150 sup
	Ghisa/Nordiker™
	238
	9,8
	8,3
	Si
	Si
	Si
	85
	2,3
	50
	Si
	Ø 120



Simulazione uscita aria calda
Hot air outlet simulation
Simulation de sortie d'air chaud
Simulation Austritt Warmluft
Simulación de salida del aire caliente

CONTO TERMICO



Per maggiori informazioni
consultare il nostro sito:

www.lanordica-extraflame.com



Bianco Infinity



716x1338x532

204

465x320

425x365x285

BIN

160 sup

Ghisa

269

kW-M 12,0

kW-N 9,4

air-1 Si

air-2 Si

air-3 Si

% 78,6

2,8

W 115

Si

Ø 100

Stufa canalizzata.
Rivestimento esterno in maiolica.
Focolare in ghisa con sistema di post combustione.
Focolare a fiamma verticale.
Telecomando di regolazione ventilazione

Ducted stove.
External facing in majolica.
Hearth in cast iron with post combustion system.
Vertical flame hearth.
Remote control ventilation.

Poêle canalisé.
Revêtement extérieur en faïence.
Foyer en fonte avec système post combustion.
Foyer à flamme verticale.
Télécommande pour régler la ventilation.

Kanalisiertes Ofen.
Äußere Verkleidung aus Majolika.
Feuerraumverkleidung aus Gusseisen mit Doppelverbrennung.
Feuerstätte mit senkrechter Flamme.
Fernbedienung zur Gebläseeinstellung.

Estufa canalizada .
Revestimiento exterior de mayólica.
Hogar en fundición con sistema de post combustión.
Hogar con llama vertical.
Control remoto para regulación de ventilación.



Wanda Classic - Canalizzata

Serie **Top Design**



Stufa canalizzata.
Rivestimento esterno in maiolica.
Focolare in ghisa con sistema di post combustione.
Focolare a fiamma verticale.
Telecomando di regolazione ventilazione.

Ducted stove.
External facing in majolica.
Hearth in cast iron with post combustion system.
Vertical flame hearth.
Remote control ventilation.

Poêle canalisé.
Revêtement extérieur en faïence.
Foyer en fonte avec système post combustion.
Foyer à flamme verticale.
Télécommande pour régler la ventilation.

Kanalisiertes Ofen.
Äußere Verkleidung aus Majolika.
Feuerraumverkleidung aus Gusseisen mit Doppelverbrennung.
Feuerstätte mit senkrechter Flamme.
Fernbedienung zur Gebläseeinstellung.

Estufa canalizada.
Revestimiento exterior de mayólica.
Hogar en fundición con sistema de post combustión.
Hogar con llama vertical.
Control remoto para regulación de ventilación.



	804x1270x530
	210
	465x320
	425x365x285
	BIN-B0
	160 sup
	Ghisa
	269
	kW-M 12,0
	kW-N 9,4
	air-1 Si
	air-2 Si
	air-3 Si
	% 78,6
	2,8
	W 115
	Si
	Ø 100

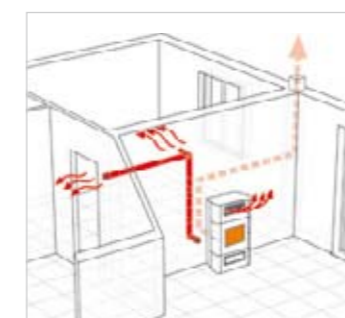

Bordeaux

Fortuna Bifacciale

Serie **Top Design**



Bianco Infinity



Visione frontale e posteriore del fuoco.
Rivestimento esterno in maiolica.
Porta fuoco curva in ghisa.
Rivestimento interno del focolare in ghisa-Nordiker™ con post combustione.
Focolare a fiamma verticale.

Front and rear view of the fire.
External facing in majolica.
Curved cast iron firedoor.
Internal facing of the hearth in cast iron and Nordiker™ with post combustion.
Vertical flame hearth.

Vue avant et arrière du feu.
Revêtement extérieur en faïence.
Porte foyer courbe et en fonte.
Revêtement intérieur du foyer en fonte/ Nordiker™ avec post combustion.
Foyer à flamme verticale.

Front- und Rückansicht des Feuers.
Äußere Verkleidung aus Majolika.
Gebeugte Feuertür aus Gusseisen.
Innenbekleidung des Feuerraums aus Gusseisen-Nordiker™ mit Doppelverbrennung.
Feuerstätte mit senkrechter Flamme.

Vista frontal y trasera del fuego.
Revestimiento exterior de mayólica.
Puerta hogar curva de fundición.
Revestimiento interior del hogar de fundición y Nordiker™ con post combustión.
Hogar con llama vertical.



Bordeaux



526x1267x505	BIN-B0	kW-M 10,0	% 80,4
178	150 sup	kW-N 8	2
315x285	Nordiker™	air-1 Si	0 100
319x460x340	229	air-2 Si	

Rivestimento esterno in acciaio verniciato.
 Porta fuoco curva in ghisa smaltata.
 Rivestimento interno del focolare in ghisa-nordiker™ con post combustione.
 Focolare a fiamma verticale.

External facing in painted steel.
 Curved cast iron firedoor.
 Internal facing of the hearth in cast iron and nordiker™ with post combustion.
 Vertical flame hearth.

Revêtement extérieure en acier peint.
 Porte foyer courbe et en fonte.
 Revêtement intérieur du foyer en fonte/ nordiker™ avec post combustion.
 Foyer à flamme verticale.

Außenverkleidung aus lackiertem Stahl.
 Gebeugte Feuerür aus Gusseisen.
 Innenbekleidung des Feuerraums aus Gusseisen-Nordiker™ mit Doppelverbrennung.
 Feuerstätte mit senkrechter Flamme.

Revestimiento externo de acero barnizado.
 Puerta hogar curva de fundición.
 Revestimiento interior del hogar de fundición y nordiker™ con post combustión.
 Hogar con llama vertical.



Nero antracite



524 x 1169 x 505	NE	kW-M 8,7	air-3 Si
158	150 sup.	kW-N 7,0	% 80,4
327x404	Ghisa-Nordiker	air-1 Si	2,0
318x470x370	200	air-2 Si	



Helga

Serie **Top Design**



Bordeaux



Rivestimento esterno in maiolica o in pietra naturale.
 Porta fuoco curva in ghisa smaltata.
 Rivestimento interno del focolare in ghisa-nordiker™ con post combustione.
 Focolare a fiamma verticale.
 Basamento e testata in ghisa smaltata.

External facing in majolica or in natural stone.
 Curved cast iron firedoor.
 Internal facing of the hearth in cast iron and nordiker™ with post combustion.
 Vertical flame hearth.
 Base and top in enamelled cast iron.

Revêtement extérieur en faïence ou en pierre.
 Porte foyer courbe et en fonte.
 Revêtement intérieur du foyer en fonte/Nordiker™ avec post combustion.
 Foyer à flamme verticale.
 Base et tête en fonte émaillée.

Außenverkleidung aus Majolika oder Naturstein.
 Gebeugte Feuertür aus Gusseisen.
 Innenbekleidung des Feuerraums aus Gusseisen-Nordiker™ mit Doppelverbrennung.
 Feuerstätte mit senkrechter Flamme.
 Sockel und Kopf aus emailliertem Gusseisen.

Revestimiento externo de mayólica o piedra natural.
 Puerta hogar curva de fundición.
 Revestimiento interior del hogar de fundición y nordiker™ con post combustión.
 Hogar con llama vertical.
 Base y cabecera de fundición esmaltada.



Pietra naturale



Titanio

524x1122x509	B0-TI-PT	kW-M 8,2	air-3 Si
165 - PT 183	130 sup.	kW-N 6,7	% 81,3
327x360	Ghisa-Nordiker™	air-1 Si	1,9
318x415x370	192	air-2 Si	





Porta fuoco in ghisa ad angolo.
Stufa angolare.
Rivestimento esterno in pietra naturale.
Rivestimento interno del focolare in ghisa-Nordiker™ con post combustione.
Focolare a fiamma verticale.

Angular door in cast iron.
Angular stove.
External facing in natural stone.
Internal facing of the hearth in cast iron and Nordiker™ with post combustion.
Vertical flame hearth.

Porte angulaire en fonte.
Poêle d'angle.
Revetement extérieur en pierre.
Revêtement intérieur du foyer en fonte/ Nordiker™ avec post combustion.
Foyer à flamme verticale.

Feuertür auf Eck aus Gusseisen.
Eckofen.
Äußere Verkleidung aus Naturstein.
Innenbekleidung des Feuerraums aus Gusseisen-Nordiker™ mit Doppelverbrennung.
Feuerstätte mit senkrechter Flamme.

Puerta hogar en fundición angular.
Estufa angular.
Rivestimiento externo en piedra natural.
Rivestimiento interior del hogar de fundición y Nordiker™ con post combustión.
Hogar con llama vertical.



Pietra naturale



425 x 1300 x 460	PT	kW-M 9,2	air-3 Si
199	130 sup.	kW-N 7,5	% 81,6
340 x 370	Ghisa Nordiker™	air-1 Si	2,1
297 x 490 x 297	215	air-2 Si	



SERIE CARILLON

Solidità, affidabilità e dinamismo contraddistinguono queste splendide stufe che ruotano di 90° sull'asse del basamento.



CARILLON
SERIES:
Solidity,
reliability and
dynamism are
the features of
these splendid
stoves which
rotate through
90° on the axis
of the base.

SÉRIE
CARILLON
Solidité, fiabilité
et dynamisme
caractérisent
ces splendides
poêles qui
pivotent de 90°
sur le socle.

SERIE
CARILLON
Beständigkeit,
Zuverlässigkeit
und Dynamik
kennzeichnen
diese
wunderbaren
Öfen, die sich
um 90° auf
der Achse des
Sockels drehen.

SERIE
CARILLON:
Solidez,
fiabilidad y
dynamismo
caracterizan
a estas
espléndidas
estufas que
giran 90°
sobre el
eje de su
basamento.

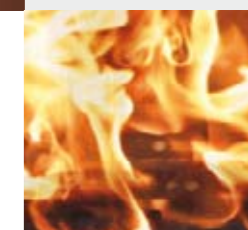



526x1267x505

184

327x404

318x470x370

BIN-B0

150 sup

Ghisa-Nordiker™

200

kW-M 8,7

kW-N 7

air-1 Si

air-2 Si

air-3 Si

% 80,4

2

Ø 100



Rivestimento esterno in maiolica.
Corpo rotante sull'asse del basamento.
Porta fuoco curva in ghisa.
Rivestimento interno del focolare in ghisa-Nordiker™ con post combustione.
Focolare a fiamma verticale.

External facing in handmade majolica.
Rotary unit on the axis of the base.
Curved cast iron fire door.
Internal facing of the hearth in cast iron and Nordiker™ with post combustion.
Vertical flame hearth.

Revêtement extérieur en faïence décoré à main.
Corps tournant sur l'axe du bâti.
Porte foyer courbe et en fonte.
Revêtement intérieur du foyer en fonte/ Nordiker™ avec post combustion.
Foyer à flamme verticale.

Außenverkleidung aus handbearbeiteter Majolika.
Drehkörper auf Sockelachse.
Gebeugte Feuertür aus Gusseisen.
Innenbekleidung des Feuerraums aus Gusseisen-Nordiker™ mit Doppelverbrennung.
Feuerstätte mit senkrechter Flamme.

Revestimiento externo de mayólica labrada a mano.
Cuerpo rotatorio en el eje de la base.
Puerta curva de fundición.
Revestimiento interior del hogar de fundición y Nordiker™ con post combustión.
Hogar con llama vertical.



Bianco Infinity

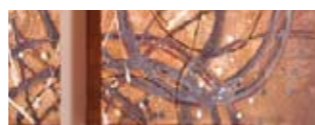



526x1267x505

176

327x404

368x470x370

BIN-B0

150 sup

Ghisa-Nordiker™

200

kW-M 8,7

kW-N 7

air-1 Si

air-2 Si

air-3 Si

% 80,4

2

Ø 100



Rivestimento esterno in maiolica.
Corpo rotante sull'asse del basamento.
Porta fuoco curva in ghisa e vetri
ceramici laterali.
Rivestimento interno del focolare in
ghisa-Nordiker™ con post combustione.
Focolare a fiamma verticale.

External facing in handmade majolica.
Rotary unit on the axis of the base.
Curved cast iron firedoor and sides
in ceramic glass.
Internal facing of the hearth in cast
iron and Nordiker™ with post
combustion.
Vertical flame hearth.

Revêtement extérieur en faïence
décoré à main.
Corps tournant sur l'axe du bâti.
Porte foyer courbe, en fonte et
vitres céramiques latérales.
Revêtement intérieur du foyer
en fonte/ Nordiker™ avec post
combustion.
Foyer à flamme verticale.

Außenverkleidung aus
handbearbeiteter Majolika.
Drehkörper auf Sockelachse.
Gebeugte Feuertür aus Gusseisen
und Keramikglas an den Seiten.
Innenbekleidung des Feuerraums
aus Gusseisen-Nordiker™ mit
Doppelverbrennung.
Feuerstätte mit senkrechter Flamme.

Revestimiento externo de mayólica
labrada a mano.
Cuerpo rotatorio en el eje de la base.
Puerta curva de fundición y cristal
cerámico en los laterales.
Revestimiento interior del hogar de
Nordiker™ con post combustión.
Hogar con llama vertical.



Bordeaux



Bianco Infinity



Ellipse*

Serie **Carillon**



Bordeaux



Rivestimento esterno in maiolica.
Corpo rotante sull'asse del basamento.
Rivestimento interno del focolare
in ghisa-Nordiker™ con post
combustione.
Apertura porta dx-sx.
Vetro ceramico resistente fino a 750°.

External facing in majolica.
Rotary unit on the axis of the base.
Internal facing of the hearth in cast
iron and Nordiker™ with post
combustion.
Right/left door opening.
Ceramic glass resistant up to 750°.

Revêtement extérieur en faïence.
Corps tournant sur l'axe du bâti.
Revêtement intérieur du foyer
en fonte/ Nordiker™ avec post
combustion.
Ouverture porte droite-gauche.
Vitre céramique résistante à 750°.

Äußere Verkleidung aus Majolika.
Drehkörper auf Sockelachse.
Innenbekleidung des Feuerraums
aus Gusseisen-Nordiker™ mit
Doppelverbrennung.
Rechte/linke Öffnungstür.
Keramikglas bis 750°
wärmebeständig.

Revestimiento exterior de mayólica.
Cuerpo rotatorio en el eje de la base.
Revestimiento interior del hogar de
fundición y Nordiker™ con post
combustión.
Apertura de puerta derecha/izquierda.
Crystal cerámico resistente a 750°.



1240x1135x680

251

540x245

500x320x360

BIN*-B0*

160 sup

Ghisa-Nordiker™

229

kW-M 10,2

kW-N 8

air-1 Si

air-2 Si

air-3 Si

% 78,1

2,4

Optional Ø 120



Bianco Infinity



Vista posteriore - Rear view - Vue arrière - Rückansicht - Vista trasera

Fireball*

Serie **Carillon**



Bianco Infinity



Rivestimento esterno in maiolica.
Corpo rotante sull'asse del basamento.
Rivestimento interno del focolare
in ghisa-Nordiker™ con post
combustione.
Apertura porta dx-sx.
Vetro ceramico resistente fino a 750°.

External facing in majolica.
Rotary unit on the axis of the base.
Internal facing of the hearth in cast
iron and Nordiker™ with post
combustion.
Right/left door opening.
Ceramic glass resistant up to 750°.

Revêtement extérieur en faïence
Corps tournant sur l'axe du bâti
Revêtement intérieur du foyer
en fonte/ Nordiker™ avec post
combustion.
Ouverture porte droite-gauche
Vitre céramique résistante à 750°.

Außenverkleidung aus Majolika.
Drehkörper auf Sockelachse.
Innenbekleidung des Feuerraums
aus Gusseisen-Nordiker™ mit
Doppelverbrennung.
Rechte/linke Öffnungstür.
Keramikglas bis 750°
wärmebeständig.

Revestimiento externo de mayólica.
Cuerpo rotatorio en el eje de la base.
Revestimiento interior del hogar de
fundición y Nordiker™ con post
combustión.
Apertura de puerta derecha/izquierda.
Crystal cerámico resistente a 750°.



892x1096x677

204

335x245

288x320x360

BIN*-B0*

130 sup

Ghisa-Nordiker™

172

kW-M 7,7

kW-N 6

air-1 Si

air-2 Si

air-3 Si

% 78,3

1,8

Ø 120



Bordeaux



Vista posteriore - Rear view - Vue arrière - Rückansicht - Vista trasera



Rivestimento esterno in acciaio e maiolica/cristallo/zebrano/wengè. Corpo rotante sull'asse del basamento. Rivestimento interno del focolare in ghisa-Nordiker™ con post combustione. Apertura porta dx-sx. Vetro ceramico resistente fino a 750°.

External facing in steel and majolica/glass/zebrano/wengè. Rotary unit on the axis of the base. Internal facing of the hearth in cast iron and Nordiker™ with post combustion. Right/left door opening. Ceramic glass resistant up to 750°.

Revêtement extérieur en acier et faïence/cristal/zebrano/wengè. Corps tournant sur l'axe du bâti. Revêtement intérieur du foyer en fonte/ Nordiker™ avec post combustion. Ouverture porte droite-gauche. Vitre céramique résistante à 750°.

Außenverkleidung aus Stahl und Majolika/Kristall/Zebrano/Wengè. Drehkörper auf Sockelachse. Innenbekleidung des Feuerraums aus Gusseisen-Nordiker™ mit Doppelverbrennung. Rechte/linke Öffnungstür. Keramikglas bis 750° wärmebeständig.

Revestimiento externo de acero y mayólica/cristal/zebrano/wengè. Cuerpo rotatorio en el eje de la base. Revestimiento interior del hogar de fundición y Nordiker™ con post combustión. Apertura de puerta derecha/izquierda. Crystal cerámico resistente a 750°.



Bordeaux

1249x1011x585

187 Mod. BO
169 Mod. CRY

635x245

600x280x360

BO-CRY

160 sup

Ghisa-Nordiker™

269

kW-M 11,8

kW-N 9,4

air-1 Si

air-2 Si

air-3 Si

% 79,6

2,8

Ø 120



Crystal

SERIE GHISA

La migliore ghisa, tecniche di lavorazione accurate ed una linea classica e sempre attuale rendono le stufe in ghisa perfette per ogni ambiente.



CAST IRON SERIES: Top quality cast iron, meticulous production techniques and a classical evergreen line make the cast iron stoves perfect for any setting.

SÉRIE FONTE: Une fonte de grande qualité, des techniques de fabrication soignées et une ligne classique et toujours actuelle: ces poêles en fonte sont parfaits pour tous les intérieurs.

SERIE GUSSEISEN: Bestes Gusseisen, sorgfältige Verarbeitungstechniken und eine klassische, immer aktuelle Linie machen die Öfen aus Gusseisen zum perfekten Begleiter für jeden Wohnraum.

SERIE GHISA: La fundición de la mejor calidad, técnicas de elaboración refinadas y una línea clásica y siempre actual armonizan perfectamente las estufas de fundición con cada ambiente.



Giulietta X

Serie **Ghisa**



Ghisa smaltata



Stufa interamente in ghisa smaltata.
Porta di carica frontale.
Ghisa ad alto rendimento termico.
Focolare in ghisa con sistema di post combustione.
Vetro ceramico resistente fino a 750°.

Stove made completely of enameled cast-iron.
Front loading door.
Very high thermic yield cast-iron.
Hearth in cast iron with post combustion system.
Ceramic glass resistant up to 750°.

Poêle entièrement en fonte émaillée.
Porte de chargement frontal.
Fonte à rendement thermique élevé.
Foyer en fonte avec système post combustion.
Vitre céramique résistante à 750°.

Ofen vollständig aus emailliertem Gusseisen.
Tür Frontbeschickung.
Gusseisen mit hoher Wärmeleistung.
Feuerraumverkleidung aus Gusseisen mit Doppelverbrennung.
Keramikglas bis 750° wärmebeständig.

Estufa completamente de fundición esmaltada.
Puerta de carga frontal.
Fundición de alto rendimiento térmico.
Hogar en fundición con sistema de post combustión.
Crystal cerámico resistente a 750°.



	487x706x430		120 s/p		kW-N 6,6		% 81
	117		Ghisa		air-1 Si		1,9
	235x280		189		air-2 Si		
	350x290x225		kW-M 8,2		air-3 Si		



Isetta con cerchi Evo

Serie **Ghisa**



Ghisa smaltata



Stufa interamente in ghisa smaltata.
Porta di carica frontale e laterale.
Ghisa ad alto rendimento termico.
Piastra in ghisa levigata.
Focolare in ghisa con sistema di post combustione.
Vetro ceramico resistente fino a 750°.

Stove made completely of enameled cast-iron.
Front and side loading door.
Very high thermic yield cast-iron.
Smooth cast iron plate.
Hearth in cast iron with post combustion system.
Ceramic glass resistant up to 750°.

Poêle entièrement en fonte émaillée.
Porte de chargement frontal et latéral.
Fonte à rendement thermique élevé.
Plaque en fonte polie.
Foyer en fonte avec système post combustion.
Vitre céramique résistante à 750°.

Ofen vollständig aus emailliertem Gusseisen.
Tür Front- und Seitenbeschickung.
Gusseisen mit hoher Wärmeleistung.
Geschliffene Gusseisenplatte.
Feuerraumverkleidung aus Gusseisen mit Doppelverbrennung.
Keramikglas bis 750° wärmebeständig.

Estufa completamente de fundición esmaltada.
Puerta de carga frontal y lateral.
Fundición de alto rendimiento térmico.
Plancha de fundición pulida.
Hogar en fundición con sistema de post combustión.
Crystal cerámico resistente a 750°.



	660x760x590		Ghisa	air-2	Si
	164		221	%	82
	380x225	kW-M	9,4		2,2
	467x280x220	kW-N	7,7		
	150 s/p	air-1	Si		

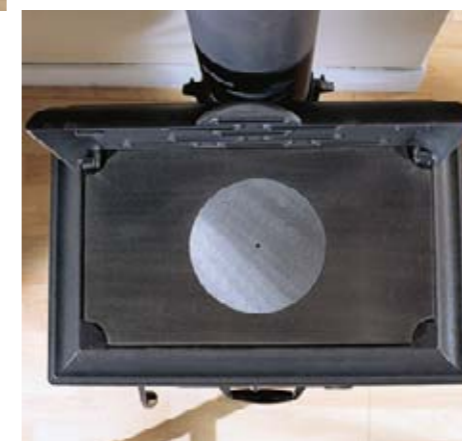

Isetta Evo

Serie **Ghisa**



Ghisa smaltata



Stufa interamente in ghisa smaltata.
Porta di carica frontale e laterale.
Ghisa ad alto rendimento termico
Focolare in ghisa con sistema di
post combustione.
Vetro ceramico resistente fino a 750°.

Stove made completely of enameled
cast-iron.
Front and side loading door .
Very high thermic yield cast-iron
Hearth in cast iron with post
combustion system.
Ceramic glass resistant up to 750°.

Poêle entièrement en fonte émaillée.
Porte de chargement frontal et latéral.
Fonte à rendement thermique élevé.
Foyer en fonte avec système post
combustion.
Vitre céramique résistante à 750°.

Ofen vollständig aus emailliertem
Gusseisen.
Tür Front- und Seitenbeschickung.
Gusseisen mit hoher Wärmeleistung.
Feuerraumverkleidung aus Gusseisen
mit Doppelverbrennung.
Keramikglas bis 750°
wärmebeständig.

Estufa completamente de
fundición esmaltada.
Puerta de carga frontal y lateral.
Fundición de alto rendimiento térmico.
Hogar en fundición con sistema de
post combustión.
Crystal cerámico resistente a 750°.



	660x706x590		Ghisa	air-2	Si
	154		221	%	82
	380x225	kW-M	9,4		2,2
	467x280x220	kW-N	7,7		
	150 s/p	air-1	Si		

Isotta con Cerchi Evo

Serie **Ghisa**

Stufa interamente in ghisa smaltata.
Porta di carica frontale e laterale.
Ghisa ad alto rendimento termico.
Piastra in ghisa levigata.
Focolare in ghisa con sistema di post combustione.
Vetro ceramico resistente fino a 750°.

stove made completely of enameled cast-iron.
Front and side loading door.
Very high thermic yield cast-iron.
Smooth cast iron plate.
Hearth in cast iron with post combustion system.
Ceramic glass resistant up to 750°.

Poêle entièrement en fonte émaillée.
Porte de chargement frontal et latéral.
Fonte à rendement thermique élevé.
Plaque en fonte polie.
Foyer en fonte avec système post combustion.
Vitre céramique résistante à 750°.



Ofen vollständig aus emailiertem Gusseisen.
Tür Front- und Seitenbeschickung.
Gusseisen mit hoher Wärmeleistung.
Geschliffene Gusseisenplatte.
Feuerraumverkleidung aus Gusseisen mit Doppelverbrennung.
Keramikglas bis 750° wärmebeständig.

Estufa completamente de fundición esmaltada.
Puerta de carga frontal y lateral.
Fundición de alto rendimiento térmico.
Plancha de fundición pulida.
Hogar en fundición con sistema de post combustión.
Crystal cerámico resistente a 750°.



Ghisa smaltata



	790x830x660		338		3,2
	216		14,5		
	519x305		11,9		
	597x360x290		air-1		Si
	150 s/p		air-2		Si
	Ghisa		%		82





Ghisa smaltata



Stufa interamente in ghisa smaltata.
Porta di carica frontale e laterale.
Ghisa ad alto rendimento termico.
Focolare in ghisa con sistema di post combustione.
Vetro ceramico resistente fino a 750°.













Stove made completely of enameled cast-iron.
Front and side loading door.
Very high thermic yield cast-iron.
Hearth in cast iron with post combustion system.
Ceramic glass resistant up to 750°.

Poêle entièrement en fonte émaillée.
Porte de chargement frontal et latéral.
Fonte à rendement thermique élevé.
Foyer en fonte avec système post combustion.
Vitre céramique résistante à 750°.

Ofen vollständig aus emailiertem Gusseisen.
Tür Front- und Seitenbeschickung.
Gusseisen mit hoher Wärmeleistung.
Feuerraumverkleidung aus Gusseisen mit Doppelverbrennung.
Keramikglas bis 750° wärmebeständig.

Estufa completamente de fundición esmaltada.
Puerta de carga frontal y lateral.
Fundición de alto rendimiento térmico.
Hogar en fundición con sistema de post combustión.
Crystal cerámico resistente a 750°.



	790x775x660		338		3,2
	205		14,5		
	519x305		11,9		
	597x360x290		Si		
	150 s/p		Si		
	Ghisa		82		



Serie Ghisa

Stufa interamente in ghisa smaltata.
Porta di carica frontale e laterale.
Ghisa ad alto rendimento termico.
Forno smaltato panoramico.
Focolare in ghisa con sistema di post combustione.
Vetro ceramico resistente fino a 750°.

Stove made completely of enameled cast-iron.
Front and side loading door.
Very high thermic yield cast-iron panoramic enameled oven.
Hearth in cast iron with post combustion system.
Ceramic glass resistant up to 750°.

Poêle entièrement en fonte émaillée.
Porte de chargement frontal et latéral.
Fonte à rendement thermique élevé.
Four émaillé panoramique.
Foyer en fonte avec système post combustion.
Vitre céramique résistante à 750°.

Ofen vollständig aus emailliertem Gusseisen.
Tür Front- und Seitenbeschickung.
Gusseisen mit hoher Wärmeleistung.
Panoramaofen emailliert.
Feuerraumverkleidung aus Gusseisen mit Doppelverbrennung.
Keramikglas bis 750° wärmebeständig.

Estufa completamente de fundición esmaltada.
Puerta de carga frontal y lateral.
Fundición de alto rendimiento térmico.
Horno panorámico esmaltado.
Hogar en fundición con sistema de post combustión.
Crystal cerámico resistente a 750°.



Ghisa smaltata



	795x1244x530		150 sup.	air-1	Si
	296		Ghisa	air-2	Si
	519x305		330	%	83,1
	597x360x290		kW-M 13,8		3,2
	443x290x305		kW-N 11,5		



Serie Ghisa

Stufa interamente in ghisa smaltata.
Ghisa ad alto rendimento termico.
Focolare in ghisa con sistema di post combustione.
Vetro ceramico resistente fino a 750°.

Stove made completely of enameled cast-iron.
Very high thermic yield cast-iron.
Hearth in cast iron with post combustion system.
Ceramic glass resistant up to 750°.

Poêle entièrement en fonte émaillée.
Fonte à rendement thermique élevé.
Foyer en fonte avec système post combustion.
Vitre céramique résistante à 750°.

Ofen vollständig aus emailliertem Gusseisen.
Gusseisen mit hoher Wärmeleistung.
Feuerraumverkleidung aus Gusseisen mit Doppelverbrennung.
Keramikglas bis 750° wärmebeständig.

Estufa completamente de fundición esmaltada.
Fundición de alto rendimiento térmico.
Hogar en fundición con sistema de post combustión.
Crystal cerámico resistente a 750°.



Ghisa smaltata

Vista posteriore - Rear view - Vue arrière - Rückansicht - Vista trasera

	404x890x397		Ghisa	air-2	Si
	85		206	air-3	Si
	233x315		8,7	%	82,6
	330x393x215		7,2		2,0
	120 sup.		Si		



Serie Ghisa



Stufa interamente in ghisa verniciata.
Ghisa ad alto rendimento termico.
Focolare in ghisa con sistema di post combustione.
Vetro ceramico resistente fino a 750°.

Fully painted cast iron stove.
Very high thermic yield cast-iron.
Hearth in cast iron with post combustion system.
Ceramic glass resistant up to 750°.

Poêle entièrement en fonte vernie.
Fonte à rendement thermique élevé.
Foyer en fonte avec système post combustion.
Vitre céramique résistante à 750°.

Ofen vollständig aus lackiertem Gusseisen.
Gusseisen mit hoher Wärmeleistung.
Feuerraumverkleidung aus Gusseisen mit Doppelverbrennung.
Keramikglas bis 750° wärmebeständig.

Estufa completamente de fundición pintada.
Fundición de alto rendimiento térmico.
Hogar en fundición con sistema de post combustión.
Crystal cerámico resistente a 750°.



Ghisa verniciata



	640x706x465		Ghisa	air-2	Si
	154		201	%	78,1
	380x245		kW-M 9,0		2,1
	485x300x220		kW-N 7		
	150 s/p		air-1	Si	





Ghisa verniciata



Stufa interamente in ghisa verniciata.
Ghisa ad alto rendimento termico.
Focolare in ghisa con sistema di post combustione.
Vetro ceramico resistente fino a 750°.

Fully painted cast iron stove.
Very high thermic yield cast-iron.
Hearth in cast iron with post combustion system.
Ceramic glass resistant up to 750°.

Poêle entièrement en fonte vernie.
Fonte à rendement thermique élevé.
Foyer en fonte avec système post combustion.
Vitre céramique résistante à 750°.

Ofen vollständig aus lackiertem Gusseisen.
Gusseisen mit hoher Wärmeleistung.
Feuerraumverkleidung aus Gusseisen mit Doppelverbrennung.
Keramikglas bis 750° wärmebeständig.

Estufa completamente de fundición pintada.
Fundición de alto rendimiento térmico.
Hogar en fundición con sistema de post combustión.
Crystal cerámico resistente a 750°.



	495x706x440		Ghisa	air-2	Si
	117		172	air-3	Si
	235x280		kW-M 7,5	%	79,8
	350x290x225		kW-N 6		1,7
	120 s/p		air-1	Si	

SERIE ARMONY

Il rivestimento in maiolica rende prezioso un prodotto ai massimi livelli qualitativi sia nella struttura che nel design.

HARMONY
SERIES:
The majolica
facing
embellishes a
product with
top quality
structure and
design.

SÉRIE
ARMONY:
Un poêle de
grande qualité
et au design
élégant enrichi
d'un revêtement
en faïence.

SERIE
ARMONY:
Die Majolika-
Verkleidung
macht dieses
Modell zum
qualitativen
Spitzenprodukt
in Stil und
Design.

SERIE
ARMONY:
El revestimiento
de mayólica
valoriza un
producto a los
máximos
niveles
cualitativos
tanto en su
estructura como
en su diseño.



Stefany Forno

Serie **Armony**



Pergamena



Focolare in ghisa con sistema di post combustione.
Vano portalegna.
Rivestimento esterno in maiolica o pietra naturale.
Focolare a fiamma verticale.
Forno smaltato estraibile.
Vetro ceramico resistente fino a 750°.

Hearth in cast iron with post combustion system.
Wood compartment.
External facing in majolica or in natural stone.
Vertical flame hearth.
Extractable enameled oven.
Ceramic glass resistant up to 750°.

Foyer en fonte avec système post combustion.
Compartment de rangement bois.
Revêtement extérieur en faïence ou en pierre.
Foyer à flamme verticale.
Four émaillé amovible.
Vitre céramique résistante à 750°.

Feuerraumverkleidung aus Gusseisen mit Doppelverbrennung.
Holzlagerfach.
Außenverkleidung aus Majolika oder Naturstein.
Feuerstätte mit senkrechter Flamme.
Herausziehbarer-und emaillierter Backfach.
Keramikglas bis 750° wärmebeständig.

Hogar en fundición con sistema de post combustión.
Compartimento para la leña.
Revestimiento externo de mayólica o piedra natural.
Hogar con llama vertical.
Horno esmaltado extraíble.
Crystal cerámico resistente a 750°.



- 660x1300x586
- 239 - mod. PT 371
- 300x340
- 377x340x388
- 417x210x275
- BO-PE-PT
- 150 s/p
- Ghisa
- 303
- kW-M 12,5
- kW-N 10,6
- air-1 Si
- air-2 Si
- air-3 Si
- % 85,1
- 2,9
- Optional
- Ø 120
- 100



Bordeaux



Pietra naturale



CONTO TERMICO

Per maggiori informazioni consultare il nostro sito:
www.lanordica-extraflame.com



✈ **Svezia 607x1254x554**
Norvegia 599x1254x554

kg **Svezia BO 191**
Svezia PT 203
Norvegia NE 188

300x340

377x340x388

Svezia: BO-PT
Norvegia: NE

150 s/p

Ghisa

303

kW-M 12,5

kW-N 10,6

air-1 Si

air-2 Si

air-3 Si

% 85,1

2,9

Optional

Ø 120

Ø 100

Focolare in ghisa con sistema di post combustione.
Rivestimento esterno in acciaio e maiolica o pietra naturale.
Cupola in acciaio smaltato.
Vano portalegna.
Porte in ghisa.
Focolare a fiamma verticale.
Vano scaldavivande.
Vetro ceramico resistente fino a 750°.

Hearth in cast iron with post combustion system.
External facing in steel and majolica or natural stone.
Enamelled steel dome.
Wood compartment.
Cast iron doors.
Vertical flame hearth.
Food warmer compartment.
Ceramic glass resistant up to 750°.

Foyer en fonte avec système post combustion.
Revêtement extérieur en acier, en faïence ou en pierre.
Coupole en acier émaillé.
Compartment de rangement bois.
Portes en fonte.
Foyer à flamme verticale.
Compartment pour réchauffer les aliments.
Vitre céramique résistante à 750°.

Feuerraumverkleidung aus Gusseisen mit Doppelverbrennung.
Außenverkleidung aus Stahl und Majolika oder Naturstein.
Kuppel aus emailliertem Stahl.
Holzlagerfach.
Tür aus Gusseisen.
Feuerstätte mit senkrechter Flamme.
Fach zum Warmhalten von Lebensmitteln.
Keramikglas bis 750° wärmebeständig.

Hogar en fundición con sistema de post combustión.
Revestimiento externo de acero y mayólica o piedra natural.
Cúpula de acero esmaltado.
Compartimento para la leña.
Puertas de fundición.
Hogar con llama vertical.
Compartimento calentaplatos.
Crystal cerámico resistente a 750°.



Norvegia



Svezia Bordeaux

CONTO TERMICO

Per maggiori informazioni consultare il nostro sito:
www.lanordica-extraflame.com



Pergamena



540x1169x564

194

315x285

377x420x385

B0-PE

130 sup

Ghisa

252

kW-M 11,0

kW-N 8,8

air-1 Si

air-2 Si

% 80

2,4

Optional

Focolare in ghisa con sistema di post combustione.
Rivestimento esterno in maiolica.
Porta in ghisa smaltata.
Vano scaldavivande.
Vetro ceramico resistente fino a 750°.

Hearth in cast iron with post combustion system.
External facing in majolica.
Enamelled cast iron door.
Food warmer compartment.
Ceramic glass resistant up to 750°.

Foyer en fonte avec système post combustion.
Revêtement extérieur en faïence.
Porte en fonte émaillée.
Compartment pour réchauffer les aliments.
Vitre céramique résistante à 750°.

Feuerraumverkleidung aus Gusseisen mit Doppelverbrennung.
Äußere Verkleidung aus Majolika.
Tür aus emailliertem Gusseisen.
Fach zum Warmhalten von Lebensmitteln.
Keramikglas bis 750° wärmebeständig.

Hogar en fundición con sistema de post combustión.
Revestimiento exterior de mayólica.
Puerta de fundición esmaltada.
Compartimento calentaplatos.
Crystal cerámico resistente a 750°.



Bordeaux



Silk Vogue Ametista



480x950x491

120 - Mod. SAM 120

230x232

271x328x308

B0*-CP*-SAM*

120 sup

Ghisa

172

kW-M 7,4

kW-N 6

air-1 Si

air-2 Si

air-3 Si

% 81,3

1,7

Optional Ø 120

Focolare in ghisa con sistema di post combustione.
Rivestimento esterno in maiolica decorata a mano.
Porta in ghisa smaltata.
Vano portalegna.
Vetro ceramico resistente fino a 750°.

Hearth in cast iron with post combustion system.
Hand enameled, majolica facing.
Enamelled cast iron door.
Wood compartment.
Ceramic glass resistant up to 750°.

Foyer en fonte avec système post combustion.
Revêtement en maïolique décoré à main.
Porte en fonte émaillée.
Compartment de rangement bois
Vitre céramique résistante à 750°.

Feuerraumverkleidung aus Gusseisen mit Doppelverbrennung.
Verkleidung aus Majolika mit handwerklichen Dekor.
Tür aus emailliertem Gusseisen
Holzlagerefach.
Keramikglas bis 750°
wärmebeständig.

Hogar en fundición con sistema de post combustión.
Revestimiento de mayolica, decoración a mano.
Puerta de fundición esmaltada.
Compartimento para la leña.
Crystal cerámico resistente a 750°.



Bordeaux



Cappuccino



Silk Vogue Ametista



Focolare in ghisa con sistema di post combustione.
Rivestimento esterno in maiolica decorata a mano.
Porta in ghisa smaltata.
Cassetto portalegna estraibile.
Vetro ceramico resistente fino a 750°.

Hearth in cast iron with post combustion system.
Hand enameled, majolica facing.
Enamelled cast iron door.
Extractable wood drawer.
Ceramic glass resistant up to 750°.

Foyer en fonte avec système post combustion.
Revêtement en maiolique décoré à main.
Porte en fonte émaillée.
Tiroir à bois amovible.
Vitre céramique résistante à 750°.

Feuerraumverkleidung aus Gusseisen mit Doppelverbrennung.
Verkleidung aus Majolika mit handwerklichen Dekor.
Tür aus emailliertem Gusseisen.
Herausziehbare Holzschublade.
Keramikglas bis 750° wärmebeständig.

Hogar en fundición con sistema de post combustión.
Revestimiento de mayolica, decoración a mano.
Puerta de fundición esmaltada.
Cajón extraíble por la leña.
Crystal cerámico resistente a 750°.

587x980x572

168

355x245

374x360x350

B0-CP-PE-SAM-TU*

130 sup

Ghisa

229

kW-M 9,9

kW-N 8

air-1 Si

air-2 Si

air-3 Si

% 80,9

2,3

Optional Ø 120



Pergamena



Bordeaux



Cappuccino



Turchese*



Bordeaux



Focolare in ghisa con sistema di post combustione.
Rivestimento esterno in maiolica decorata a mano.
Porta in ghisa smaltata.
Forno da 42 l.
Cassetto portalegna estraibile.
Vetro ceramico resistente fino a 750°.

Hearth in cast iron with post combustion system.
Hand enameled, majolica facing.
Enamelled cast iron door.
Oven of 42 l.
Extractable wood drawer.
Ceramic glass resistant up to 750°.

Foyer en fonte avec système post combustion.
Revêtement en maiolique décoré à main.
Porte en fonte émaillée.
Four de 42 l.
Tiroir à bois amovible.
Vitre céramique résistante à 750°.

Feuerraumverkleidung aus Gusseisen mit Doppelverbrennung.
Verkleidung aus Majolika mit handwerklichen Dekor.
Tür aus emailliertem Gusseisen.
Ofen mit 42 l Inhalt.
Herausziehbare Holzschublade.
Keramikglas bis 750° wärmebeständig.

Hogar en fundición con sistema de post combustión.
Revestimiento de mayolica, decoración a mano.
Puerta de fundición esmaltada
Horno de 42 l.
Cajón extraíble por la leña.
Crystal cerámico resistente a 750°.

587x1423x572

242

355x245

379x370x327

330x300x370

B0-CP-SAM

130 sup

Ghisa

260

kW-M 10,6

kW-N 9,1

air-1 Si

air-2 Si

air-3 Si

% 86

2,4

Optional Ø 120



Cappuccino



Silk Vogue Ametista



CONTO TERMICO



Per maggiori informazioni consultare il nostro sito:

www.lanordica-extraflame.com



Bordeaux



Focolare in ghisa con sistema di post combustione.
Rivestimento esterno in maiolica.
Porta in ghisa smaltata.
Vetro ceramico resistente fino a 750°.

Hearth in cast iron with post combustion system.
External facing in majolica.
Enamelled cast iron door.
Ceramic glass resistant up to 750°.

Foyer en fonte avec système post combustion.
Revêtement extérieur en faïence.
Porte en fonte émaillée.
Vitre céramique résistante à 750°.

Feuerraumverkleidung aus Gusseisen mit Doppelverbrennung.
Äußere Verkleidung aus Majolika.
Tür aus emailliertem Gusseisen.
Keramikglas bis 750° wärmebeständig.

Hogar en fundición con sistema de post combustión.
Revestimiento exterior de mayólica.
Puerta de fundición esmaltada.
Crystal cerámico resistente a 750°.

495x906x468

133 kg

210x255

273x370x300

B0-CP-PE

120 sup

Ghisa

172 m³

kW-M 7,3

kW-N 6

air-1 Si

air-2 Si

air-3 Si

% 82

1,7



Pergamena



Cappuccino

Gaia Forno

Serie **Armony**



Pergamena



Focolare in ghisa con sistema di post combustione.
Rivestimento esterno in maiolica.
Porta in ghisa smaltata.
Forno smaltato.
Vetro ceramico resistente fino a 750°.

Hearth in cast iron with post combustion system.
External facing in majolica.
Enamelled cast iron door.
Enamelled oven.
Ceramic glass resistant up to 750°.

Foyer en fonte avec système post combustion.
Revêtement extérieur en faïence.
Porte en fonte émaillée.
Four émaillé.
Vitre céramique résistante à 750°.

Feuerraumverkleidung aus Gusseisen mit Doppelverbrennung.
Äußere Verkleidung aus Majolika.
Tür aus emailliertem Gusseisen.
Emaillierter Ofen.
Keramikglas bis 750° wärmebeständig.

Hogar en fundición con sistema de post combustión.
Revestimiento exterior de mayólica.
Puerta de fundición esmaltada.
Horno esmaltado.
Crystal cerámico resistente a 750°.



495x1331x468

186 kg

210x255

273x370x300

227x296x290

BO-CP-PE

120 sup

Ghisa

172 m³

kW-M 7,3

kW-N 6

air-1 Si

air-2 Si

air-3 Si

% 82

1,7



Bordeaux



Cappuccino



Bordeaux



Focolare in ghisa con sistema di post combustione.
Rivestimento esterno in maiolica e acciaio.
Porta in ghisa smaltata.
Vano portalegna.
Vetro ceramico resistente fino a 750°.

Hearth in cast iron with post combustion system.
External facing in majolica and steel.
Enamelled cast iron door.
Wood compartment.
Ceramic glass resistant up to 750°.

Foyer en fonte avec système post combustion.
Revêtement extérieur en acier et en faïence.
Porte en fonte émaillée.
Compartiment de rangement bois.
Vitre céramique résistante à 750°.

Feuerraumverkleidung aus Gusseisen mit Doppelverbrennung.
Außenverkleidung aus Majolika und Stahl.
Tür aus emailliertem Gusseisen.
Holzlagerfach.
Keramikglas bis 750° wärmebeständig.

Hogar en fundición con sistema de post combustión.
Revestimiento externo de mayólica y acero.
Puerta de fundición esmaltada.
Compartimento para la leña.
Crystal cerámico resistente a 750°.



483x941x472

109 kg

230x232

270x328x315

AL-B0-PE

120 sup

Ghisa

172 m³

kW-M 7,4

kW-N 6

air-1 Si

air-2 Si

air-3 Si

% 81,3

1,7

Optional Ø 120



Albicocca



Pergamena





Bordeaux

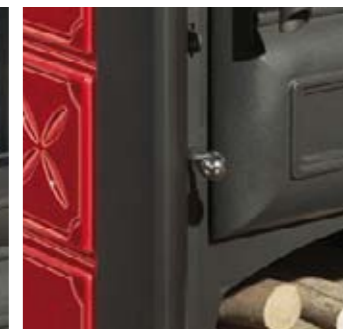
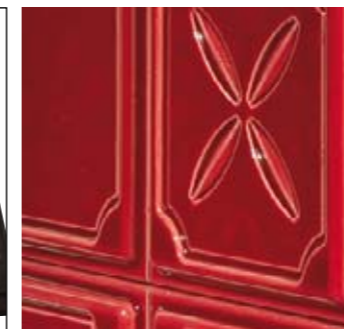

Focolare in ghisa con sistema di post combustione.
Rivestimento esterno in maiolica e acciaio.
Porta in ghisa.
Plastra in ghisa levigata.
Vano portalegna.
Vetro ceramico resistente fino a 750°.

Hearth in cast iron with post combustion system.
External facing in majolica and steel.
Door in cast iron.
Smooth cast iron plate.
Wood compartment.
Ceramic glass resistant up to 750°.

Foyer en fonte avec système post combustion.
Revêtement extérieur en acier et en faïence.
Porte en fonte.
Plaque en fonte polie.
Compartment de rangement bois.
Vitre céramique résistante à 750°.

Feuerraumverkleidung aus Gusseisen mit Doppelverbrennung.
Außenverkleidung aus Majolika und Stahl.
Tür aus Gusseisen.
Geschliffene Gusseisenplatte.
Holzlagerefach.
Keramikglas bis 750° wärmebeständig.

Hogar en fundición con sistema de post combustión.
Revestimiento externo de mayólica y acero.
Puerta de hierro fundido.
Plancha de fundición pulida.
Compartimento para la leña.
Crystal cerámico resistente a 750°.



570x950x560

135 kg

340x245

380x325x350

BO-CP

130 sup

Ghisa

229

kW-M 10,2

kW-N 8

air-1 Si

air-2 Si

air-3 Si

% 78,1

2,4

Optional Ø 120



Cappuccino



Bordeaux



Focolare in ghisa con sistema di post combustione.
Rivestimento esterno in maiolica e acciaio.
Porta in ghisa smaltata.
Vano portalegna.
Vetro ceramico resistente fino a 750°.

Hearth in cast iron with post combustion system.
External facing in majolica and steel.
Enamelled cast iron door.
Wood compartment.
Ceramic glass resistant up to 750°.

Foyer en fonte avec système post combustion.
Revêtement extérieur en acier et en faïence.
Porte en fonte émaillée.
Compartment de rangement bois.
Vitre céramique résistante à 750°.

Feuerraumverkleidung aus Gusseisen mit Doppelverbrennung.
Außenverkleidung aus Majolika und Stahl.
Tür aus emailliertem Gusseisen Holzlagerfach.
Keramikglas bis 750° wärmebeständig.

Hogar en fundición con sistema de post combustión.
Revestimiento externo de mayólica y acero.
Puerta de fundición esmaltada.
Compartimento para la leña.
Crystal cerámico resistente a 750°.

424x930x473

103

230x232

270x328x315

B0-PE

120 sup

Ghisa

172

kW-M 7,4

kW-N 6

air-1 Si

air-2 Si

air-3 Si

% 81,3

1,7

Optional Ø 120



Pergamena





Pietra Naturale



Focolare in ghisa con sistema di post combustione.
Rivestimento esterno in pietra naturale.
Porta in ghisa smaltata.
Vano portalegna.
Vetro ceramico resistente fino a 750°.

Hearth in cast iron with post combustion system.
External facing in natural stone.
Enamelled cast iron door.
Wood compartment.
Ceramic glass resistant up to 750°.

Foyer en fonte avec système post combustion.
Revetement extérieur en pierre.
Porte en fonte émaillée.
Compartment de rangement bois.
Vitre céramique résistante à 750°.

Feuerraumverkleidung aus Gusseisen mit Doppelverbrennung.
Äußere Verkleidung aus Naturstein.
Tür aus emailliertem Gusseisen.
Holzlagerefach.
Keramikglas bis 750° wärmebeständig.

Hogar en fundición con sistema de post combustión.
Revestimiento externo en piedra natural.
Puerta de fundición esmaltada.
Compartimento para la leña.
Crystal cerámico resistente a 750°.



438x930x470

159

230x232

270x328x315

PT

120 sup

Ghisa

172

kW-M 7,4

kW-N 6

air-1 Si

air-2 Si

air-3 Si

% 81,3

1,7

Optional Ø 120





Pietra Naturale



Rivestimento esterno in pietra naturale.
Porta in ghisa.
Rivestimento interno del focolare in ghisa-Nordiker™ con post combustione.
Regolazione della griglia fuoco.
Cassetto portacenere a scomparsa.
Possibilità di prendere all'esterno l'aria comburente.
Vetro ceramico resistente fino a 750°.

External facing in natural stone
Door in cast iron.
Internal facing of the hearth in cast iron and Nordiker™ with post combustion.
Fire grate adjustment.
Concealed ash drawer.
Option of taking combustion air outside.
Ceramic glass resistant up to 750°.

Revetement extérieur en pierre.
Porte en fonte.
Revêtement intérieur du foyer en fonte/ Nordiker™ avec post combustion.
Réglage de la grille feu.
Tiroir et cendrier escamotable.
Possibilité de prendre l'air comburant de l'extérieur.
Vitre céramique résistante à 750°.

Äußere Verkleidung aus Naturstein.
Tür aus Gusseisen.
Innenbekleidung des Feuerraums aus Gusseisen-Nordiker™ mit Doppelverbrennung.
Einstellung des Feuerrosts.
Unsichtbare Ascheschublade.
Möglichkeit, die Verbrennungsluft von außen zuzuleiten.
Keramikglas bis 750° wärmebeständig.

Revestimiento externo en piedra natural.
Puerta de hierro fundido.
Revestimiento interior del hogar de fundición y Nordiker™ con post combustión.
Regulación de la rejilla de fuego.
Cajón cenicero extraíble.
Posibilidad de captar el aire comburente desde el exterior.
Crystal cerámico resistente a 750°.



540x950x478

243

300x415

295x390x300

PT

130 sup

Ghisa-Nordiker™

215

kW-M 9,4

kW-N 7,5

air-1 Si

air-2 Si

air-3 Si

% 80

2,2

Optional Ø 120



Ester Forno Evo

Serie **Armony**

Pietra Naturale



Äußere Verkleidung aus Naturstein.
Tür aus Gusseisen.
Innenbekleidung des Feuerraums
aus Gusseisen-Nordiker™ mit
Doppelverbrennung.
Unsichtbare Ascheschublade.
Ofen aus porzellan-emailliertem Stahl.
Keramikglas bis 750°
wärmebeständig.

Revestimiento externo en piedra
natural.
puerta de hierro fundido.
Revestimiento interior del hogar de
fundición y Nordiker™ con post
combustión.
Cajón cenicero extraíble.
Horno de acero esmaltado de
porcelana.
Crystal cerámico resistente a 750°.

Rivestimento esterno in pietra naturale.
Porta in ghisa.
Rivestimento interno del focolare
in ghisa-Nordiker™ con post
combustione.
Cassetto portacenere a scomparsa.
Forno in acciaio smaltato porcellanato.
Vetro ceramico resistente fino a 750°.

External facing in natural stone.
Door in cast iron.
Internal facing of the hearth in cast
iron and Nordiker™ with post
combustion.
Concealed ash drawer.
Porcelain enamelled steel oven.
Ceramic glass resistant up to 750°.

Revetement extérieur en pierre.
Porte en fonte.
Revêtement intérieur du foyer
en fonte/ Nordiker™ avec post
combustion.
Tiroir et cendrier escamotable.
Four en acier émaillé porcelainé.
Vitre céramique résistante à 750°.



540x1300x478

317

300x340

295x315x300

268x238x338

PT

130 sup

Ghisa-Nordiker™

235

kW-M 9,5

kW-N 8,2

air-1 Si

air-2 Si

air-3 Si

% 86,7

2,2

Optional Ø 120

CONTO TERMICO



Per maggiori informazioni
consultare il nostro sito:

www.lanordica-extraflame.com



Nero Antracite



Focolare in ghisa con sistema di post combustione.
Rivestimento esterno in acciaio.
Porte in ghisa smaltata.
Vano portalegna.
Vetro ceramico resistente fino a 750°.

Hearth in cast iron with post combustion system.
Steel external facing.
Enamelled cast iron doors.
Wood compartment.
Ceramic glass resistant up to 750°.

Foyer en fonte avec système post combustion.
Revêtement extérieur en acier.
Portes en fonte émaillée.
Compartment de rangement bois.
Vitre céramique résistante à 750°.

Feuerraumverkleidung aus Gusseisen mit Doppelverbrennung.
Außenverkleidung aus Stahl.
Türen aus emailliertem Gusseisen.
Holzlagerfach.
Keramikglas bis 750° wärmebeständig.

Hogar en fundición con sistema de post combustión.
Revestimiento externo de acero.
Puertas de fundición esmaltada.
Compartimento para la leña.
Crystal cerámico resistente a 750°.



414x930x471

92

230x232

270x328x315

NE*

120 sup

Ghisa

172

kW-M 7,4

kW-N 6

air-1 Si

air-2 Si

air-3 Si

% 81,3

1,7

Optional Ø 120

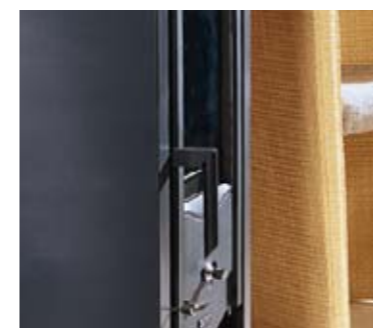

SERIE ROSSELLA

La compattezza dei materiali, l'armonia delle linee e la sicurezza nell'utilizzo sono le caratteristiche fondamentali delle stufe "La Nordica".



ROSSELLA SERIES:
Solid materials, harmonious lines and safe use are the fundamental characteristics of "La Nordica" stoves.

SÉRIE ROSSELLA:
La compacité des matériaux, l'harmonie des lignes et la sécurité d'utilisation sont les caractéristiques fondamentales des poêles "La Nordica".

SERIE ROSSELLA:
Die Kompaktheit der Materialien, die Harmonie der Linien und die Sicherheit im Gebrauch sind die grundlegenden Eigenschaften der Öfen "La Nordica".

SERIE ROSSELLA:
Materiales compactos, armonía de las líneas y un uso seguro son las características esenciales de las estufas "La Nordica".



Rossella R1

Serie **Rossella**



Liberty Pergamena



Focolare in ghisa con sistema di post combustione.
Rivestimento esterno in maiolica o pietra naturale.
Porte e testata in ghisa smaltata.
Vetro ceramico resistente fino a 750°.

Hearth in cast iron with post combustion system.
External facing in majolica or in natural stone.
Doors and top in cast iron.
Ceramic glass resistant up to 750°.

Foyer en fonte avec système post combustion.
Revêtement extérieur en faïence ou en pierre.
Portes et élément supérieur en fonte émaillée.
Vitre céramique résistante à 750°.

Feuerraumverkleidung aus Gusseisen mit Doppelverbrennung.
Außenverkleidung aus Majolika oder Naturstein.
Türen und Kopf aus emailliertem Gusseisen.
Keramikglas bis 750° wärmebeständig.

Hogar en fundición con sistema de post combustión.
Revestimiento externo de mayólica o piedra natural.
Puertas y cabecera de fundición esmaltada.
Crystal cerámico resistente a 750°.



578x915x586

155 Mod. BO-PE
170 Mod. PT

315x285

377x420x385

Liberty: PE-BO
PT

130 sup

Ghisa

252

kW-M 11,0

kW-N 8,8

air-1 Si

air-2 Si

% 80

2,4

Optional



Liberty Bordeaux



Pietra Naturale





Liberty Bordeaux



559x915x536

137

355x245

374x325x350

B0-PE

130 sup

Ghisa

229

kW-M 9,9

kW-N 8

air-1 Si

air-2 Si

air-3 Si

% 80,9

2,3

Optional Ø 120

Focolare in ghisa con sistema di post combustione.
Rivestimento esterno in maiolica.
Porta, testata e basamento in ghisa smaltata.
Cassetto portalegna estraibile.
Vetro ceramico resistente fino a 750°.

Hearth in cast iron with post combustion system.
External facing in majolica.
Enameled cast iron top, door and base.
Extractable wood drawer.
Ceramic glass resistant up to 750°.

Foyer en fonte avec système post combustion.
Revêtement extérieur en faïence.
Porte, élément supérieur et bâti en fonte émaillée.
Tiroir à bois amovible.
Vitre céramique résistante à 750°.

Feuerraumverkleidung aus Gusseisen mit Doppelverbrennung.
Äußere Verkleidung aus Majolika.
Tür, Kopf und Sockel aus emailliertem Gusseisen.
Herausziehbare Holzschublade.
Keramikglas bis 750° wärmebeständig.

Hogar en fundición con sistema de post combustión.
Revestimiento exterior de mayólica.
Puerta, cabecera y base de fundición esmaltada.
Cajón extraíble por la leña.
Crystal cerámico resistente a 750°.



Liberty Pergamena

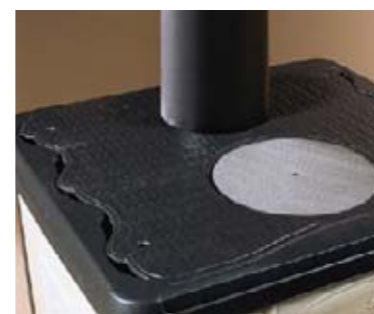



Focolare in ghisa con sistema di post combustione.
Rivestimento esterno in pietra naturale.
Porta, testata e basamento in ghisa smaltata.
Cassetto portalegna estraibile.
Vetro ceramico resistente fino a 750°.

Hearth in cast iron with post combustion system.
External facing in natural stone.
Enameled cast iron top, door and base.
Extractable wood drawer.
Ceramic glass resistant up to 750°.

Foyer en fonte avec système post combustion.
Revetement extérieur en pierre.
Porte, élément supérieur et bâti en fonte émaillée.
Tiroir à bois amovible.
Vitre céramique résistante à 750°.

Feuerraumverkleidung aus Gusseisen mit Doppelverbrennung.
Äußere Verkleidung aus Naturstein.
Tür, Kopf und Sockel aus emailliertem Gusseisen.
Herausziehbare Holzschublade.
Keramikglas bis 750° wärmebeständig.

Hogar en fundición con sistema de post combustión.
Revestimiento externo en piedra natural.
Puerta, cabecera y base de fundición esmaltada.
Cajón extraíble por la leña.
Crystal cerámico resistente a 750°.



↓ 559x915x536

kg 156

355x245

374x325x350

PT

130 sup

Ghisa

m³ 229

kW-M 9,9

kW-N 8

air-1 Si

air-2 Si

air-3 Si

% 80,9

2,3

Optional Ø 120

Pietra Naturale

Rossella Plus Forno Evo

Serie **Rossella**



Liberty Pergamena



Focolare in ghisa con sistema di post combustione.
Rivestimento esterno in maiolica o pietra naturale.
Porta, testata e basamento in ghisa smaltata.
Cassetto portalegna estraibile.
Forno smaltato.
Vetro ceramico resistente fino a 750°.

Hearth in cast iron with post combustion system.
External facing in majolica or in natural stone.
Enameled cast iron top, door and base.
Extractable wood drawer.
Enameled oven.
Ceramic glass resistant up to 750°.

Foyer en fonte avec système post combustion.
Revêtement extérieur en faïence ou en pierre.
Porte, élément supérieur et bâti en fonte émaillée.
Tiroir à bois amovible.
Four émaillé.
Vitre céramique résistante à 750°.

Feuerraumverkleidung aus Gusseisen mit Doppelverbrennung.
Außenverkleidung aus Majolika oder Naturstein.
Tür, Kopf und Sockel aus emailiertem Gusseisen.
Herausziehbare Holzschublade.
Emaillierter Ofen.
Keramikglas bis 750° wärmebeständig.

Hogar en fundición con sistema de post combustión.
Revestimiento externo de mayólica o piedra natural.
Puerta, cabecera y base de fundición esmaltada.
Cajón extraíble por la leña.
Horno esmaltado.
Crystal cerámico resistente a 750°.



559x1359x536

195 mod. BO-PE
219 mod. PT

355x245

379x370x327

330x300x370

BO-PE-PT

130 sup

Ghisa

260

KW-M 10,6

KW-N 9,1

air-1 Si

air-2 Si

air-3 Si

% 86

2,4

Optional Ø 120



Liberty Bordeaux



Pietra Naturale

CONTO TERMICO

Per maggiori informazioni consultare il nostro sito:
www.lanordica-extraflame.com



SERIE F.D.G. FULVIA, DORELLA E GEMMA

La ghisa realizzata dalle fonderie con i migliori sistemi di produzione e controllo qualità è garanzia di solidità ed affidabilità delle stufe "La Nordica".

F.D.G. SERIES
Fulvia, Dorella
and Gemma:
Cast iron made
in foundries
using the best
production and
quality control
systems
guarantees the
solidity and
reliability of "La
Nordica" stoves.

SÉRIE F.D.G.
Fulvia, Dorella
et Gemma:
La fonte
réalisée par les
fonderies avec
les meilleurs
systèmes de
production et
contrôle qualité
sont une garantie
de solidité et de
fiabilité des
poêles "La
Nordica".

SERIE F.D.G.
Fulvia, Dorella
und Gemma:
Das mit den
besten
Produktionssy-
stemen und
Qualitätskontrol-
len hergestellte
Gusseisen ist
die Garantie für
Beständigkeit und
Zuverlässigkeit
der "La Nordica"
Öfen.

SERIE F.D.G.
Fulvia, dorella y
gemma:
La fundición
realizada en
fundiciones con los
mejores sistemas
de producción y
control de calidad
son la garantía de
solidez y fiabilidad
de las estufas "La
Nordica".





Liberty Pergamena



Focolare in ghisa.
Rivestimento esterno in maiolica o pietra naturale.
Porte e testata in ghisa smaltata.
Vetro ceramico resistente fino a 750°.

Cast iron hearth.
External facing in majolica or natural stone.
Doors and top in cast iron.
Ceramic glass resistant up to 750°.

Foyer en fonte.
Revêtement extérieur en faïence ou en pierre.
Portes et élément supérieur en fonte émaillée.
Vitre céramique résistante à 750°.

Feuerstelle aus Gusseisen.
Außenverkleidung aus Majolika oder Naturstein.
Türen und Kopf aus emailiertem Gusseisen.
Keramikglas bis 750° wärmebeständig.

Hogar de fundición.
Revestimiento externo de mayólica o piedra natural.
Puertas y cabecera de fundición esmaltada.
Crystal cerámico resistente a 750°.



488x862x477

109 mod. BO-PE
119 mod. PT

210x255

273x370x320

BO-PE-PT

120 sup

Ghisa

172

kW-M 7,3

kW-N 6

air-1 Si

air-2 Si

air-3 Si

% 82

1,7



Liberty Bordeaux



Pietra Naturale

Fulvia Forno

Serie **F.D.G.**



Pietra Naturale



Focolare in ghisa.
Rivestimento esterno in maiolica o pietra naturale.
Porte e testata in ghisa smaltata.
Forno smaltato.
Vetro ceramico resistente fino a 750°.

Cast iron hearth.
External facing in majolica or natural stone.
Doors and top in cast iron.
Enameled oven.
Ceramic glass resistant up to 750°.

Foyer en fonte.
Revêtement extérieur en faïence ou en pierre.
Portes et élément supérieur en fonte émaillée.
Four émaillé.
Vitre céramique résistante à 750°.

Feuerstelle aus Gusseisen.
Außenverkleidung aus Majolika oder Naturstein.
Türen und Kopf aus emailliertem Gusseisen.
Emaillierter Ofen.
Keramikglas bis 750° wärmebeständig.

Hogar de fundición.
Revestimiento externo de mayólica o piedra natural.
Puertas y cabecera de fundición esmaltada.
Horno esmaltado.
Crystal cerámico resistente a 750°.



488x1288x477

155 mod. BO-PE
173 mod. PT

210x255

273x370x320

227x296x290

BO-PE-PT

120 sup

Ghisa

172

kW-M 7,3

kW-N 6

air-1 Si

air-2 Si

air-3 Si

% 82

1,7



Liberty Bordeaux



Liberty Pergamena

Dorella L8 X

Serie **F.D.G.**



Liberty Pergamena



Focolare in ghisa.
Rivestimento esterno in maiolica o pietra naturale.
Porte e testata in ghisa smaltata.
Vetro ceramico resistente fino a 750°.

Cast iron hearth.
External facing in majolica or in natural stone.
Doors and top in cast iron.
Ceramic glass resistant up to 750°.

Foyer en fonte.
Revêtement extérieur en faïence ou en pierre.
Portes et élément supérieur en fonte émaillée.
Vitre céramique résistante à 750°.

Feuerstelle aus Gusseisen.
Außenverkleidung aus Majolika oder Naturstein.
Türen und Kopf aus emailiertem Gusseisen.
Keramikglas bis 750° wärmebeständig.

Hogar de fundición.
Revestimiento externo de mayólica o piedra natural.
Puertas y cabecera de fundición esmaltada.
Crystal cerámico resistente a 750°.



465x845x491

90 mod. B0-PE
102 mod. PT

214x213

285X366X300

Liberty: B0-PE
L8: PT

120 sup

Ghisa

195

kW-M 8,8

kW-N 6,8

air-1 Si

air-2 Si

% 77

2,1



Pietra Naturale



Liberty Bordeaux



Elegance Bordeaux



Focolare in ghisa.
Rivestimento esterno in maiolica o
pietra naturale.
Porte e testata in ghisa smaltata.
Vetro ceramico resistente fino a 750°.

Cast iron hearth.
External facing in majolica or in
natural stone.
Doors and top in cast iron.
Ceramic glass resistant up to 750°.

Foyer en fonte.
Revêtement extérieur en faïence
ou en pierre.
Portes et élément supérieur en
fonte émaillée.
Vitre céramique résistante à 750°.

Feuerstelle aus Gusseisen.
Außenverkleidung aus Majolika
oder Naturstein.
Türen und Kopf aus emailiertem
Gusseisen.
Keramikglas bis 750°
wärmebeständig.

Hogar de fundición.
Revestimiento externo de mayólica
o piedra natural.
Puertas y cabecera de fundición
esmaltada.
Crystal cerámico resistente a 750°.



460x840x495

85 mod. BO-CP-PE-SK
98 mod. PT

220x215

220x370x290

Liberty: BO-PE
Elegance: BO-CP
PT

120 sup

Ghisa

172

kW-M 7,3

kW-N 6

air-1 Si

air-2 Si

air-3 Si

% 82,2

1,7



Elegance Cappuccino



Pietra Naturale



Liberty Bordeaux



Liberty Pergamena

Gemma Forno

Serie **F.D.G.**



Elegance Bordeaux

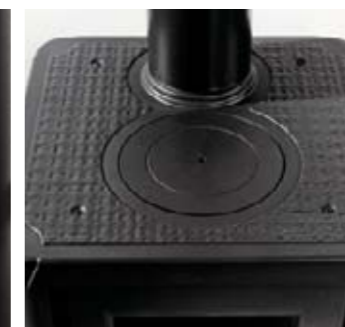

Rivestimento esterno in maiolica o pietra naturale.
Focolare in ghisa.
Forno smaltato.
Porte e testata in ghisa smaltata.
Vetro ceramico resistente fino a 750°.

External facing in majolica or in natural stone.
Cast iron hearth.
Enameled oven.
Doors and top in cast iron.
Ceramic glass resistant up to 750°.

Revêtement extérieur en faïence ou en pierre.
Foyer en fonte.
Four émaillé.
Portes et élément supérieur en fonte émaillée.
Vitre céramique résistante à 750°.

Außenverkleidung aus Majolika oder Naturstein.
Feuerstelle aus Gusseisen.
Emaillierter Ofen.
Türen und Kopf aus emailliertem Gusseisen.
Keramikglas bis 750° wärmebeständig.

Revestimiento externo de mayólica o piedra natural.
Hogar de fundición.
Horno esmaltado.
Puertas y cabecera de fundición esmaltada.
Crystal cerámico resistente a 750°.



460x1207x495

121 mod. B0-CP
134 mod. PT

220x215

220x370x290

227x296x290

Elegance B0-CP
PT

120 sup

Ghisa

200

kW-M 8,2

kW-N 7

air-1 Si

air-2 Si

air-3 Si

% 85,3

1,9



Elegance Cappuccino



Pietra Naturale

CONTO TERMICO

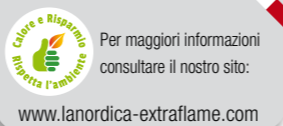

Per maggiori informazioni consultare il nostro sito:

www.lanordica-extraflame.com

SERIE BRUCIATUTTO

Robuste, funzionali ed efficienti, sono realizzate nei colori della tradizione. Le stufe bruciatutto, una linea prodotto sempre attuale e vincente.



BRUCIATUTTO
SERIES:
Robust,
functional,
efficient and
available in
traditional
colours.
Multifuel stoves,
a successful
evergreen line.

SÉRIE
BRUCIATUTTO:
Robustes,
fonctionnelles
et efficaces
elles sont
réalisées dans
des couleurs
traditionnelles.
les poêles
bruciatutto, une
ligne toujours
actuelle et
élégante.

SERIE
BRUCIATUTTO:
Robust,
funktionell und
effizient, in den
traditionellen
Farben.
Die Öfen
Bruciatutto, eine
immer aktuelle
und gewinnende
Produktlinie.

SERIE
BRUCIATUTTO:
Robustas,
funcionales y
eficientes, de
producen con
los colores de
la tradición.
las estufas
bruciatutto, una
línea de producto
actual y vigente



Super Max & Super Junior

Serie **Bruciatutto**



Super Junior Nera

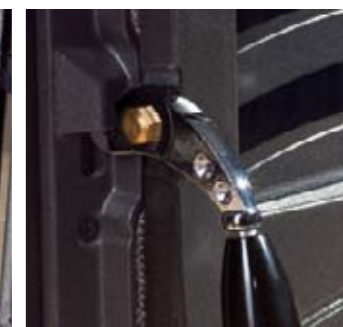

Rivestimento esterno in acciaio smaltato.
Porta con apertura a libro.
Scuotigriglia azionabile dall'esterno.
Focolare in ghisa.
Porte e testata in ghisa smaltata.
Maniglie in ottone cromato.
Vetro ceramico resistente fino a 750°.

Enamelled steel external facing
Bi-fold doors.
External grid shaker.
Cast iron hearth.
Doors and top in cast iron.
Chrome brass handles.
Ceramic glass resistant up to 750°.

Revêtement extérieur en acier émaillé.
Porte à deux vantaux.
Dispositif pour secouer la grille, actionnable de l'extérieur.
Foyer en fonte.
Portes et élément supérieur en fonte émaillée.
Poignée en laiton chromé.
Vitre céramique résistante à 750°.

Außenverkleidung aus emailiertem Stahl.
90° Türöffnung.
Rostrüttler von außen zu betätigen.
Feuerstelle aus Gusseisen.
Türen und Kopf aus emailiertem Gusseisen.
Handgriffe aus verchromtem Messing.
Keramikglas bis 750°
wärmebeständig.

Revestimiento externo de acero esmaltado.
Puerta con apertura plegable.
Sacudidor de rejilla accionable desde el exterior.
Hogar de fundición.
Puertas y cabecera de fundición esmaltada.
Tiradores de latón cromado.
Crystal cerámico resistente a 750°.



Super Junior

	360x771x419	kW-M	6,3
	64	kW-N	5
	215x175	air-1	Si
	206x280x260	air-2	Si
	NE-VE	air-3	Si
	120 sup	%	80
	Ghisa		1,5
	143		

Super Max

	402x811x482	kW-M	7,5
	75	kW-N	6
	215x175	air-1	Si
	215x315x285	air-2	Si
	NE-VE	air-3	Si
	120 sup	%	80,3
	Ghisa		1,9
	172		



Super Junior Verde



Super Max Verde



Super Max Nera

Serie **Bruciatutto**

Major - Max & Junior

Rivestimento esterno in acciaio smaltato.
Porta con apertura a libro.
Scuotigriglia azionabile dall'esterno.
Porte e testata in ghisa smaltata.
Maniglie in ottone cromato.

Enamelled steel external facing.
Bi-fold doors.
External grid shaker.
Doors and top in cast iron.
Polished brass handles.

Revêtement extérieur en acier émaillé.
Porte à deux vantaux.
Dispositif pour secouer la grille, actionnable de l'extérieur.
Portes et élément supérieur en fonte émaillée.
Poignée en laiton chromé.



Außenverkleidung aus emailiertem Stahl.
90° Türöffnung.
Rostrüttler von außen zu betätigen.
Türen und Kopf aus emailiertem Gusseisen.
Handgriffe aus verchromtem Messing.

Revestimiento externo de acero esmaltado.
Puerta con apertura plegable.
Sacudidor de rejilla accionable desde el exterior.
Puertas y cabecera de fundición esmaltada.
Tiradores de latón cromado.

Major Nero



Junior Verde



Junior Nero



Max Verde*



Max Nero*



Major	
	402x820x457
	75
	225x134
	264x450x264
	NE
	120 sup
	Refrattario
	186
	12,3
	6,5
	Si
	Si
	No
	53
	2,8

Max*	
	402x820x457
	71
	195x220
	215x310x275
	NE-VE
	120 sup
	Ghisa
	172
	8,6
	6
	Si
	Si
	Si
	70
	2

Junior	
	360x750x415
	64
	195x220
	205x280x270
	NE-VE
	120 sup
	Ghisa
	143
	6,7
	5
	Si
	Si
	Si
	75
	1,5





Rivestimento esterno in acciaio smaltato.
 Scuotigriglia azionabile dall'esterno.
 Maniglie cromate.
 Testata in ghisa smaltata.

Enamelled steel external facing.
 External grid shaker.
 Chrome-plated handles.
 Enamelled cast iron top.

Revêtement extérieur en acier émaillé.
 Dispositif pour secouer la grille,
 actionnable de l'extérieur.
 Poignées chromées.
 Élément supérieur en fonte émaillée.

Außenverkleidung aus emailliertem
 Stahl.
 Rostrüttler von außen zu betätigen.
 Verchromte Griffe.
 Kopf aus emailliertem Gusseisen.

Revestimiento externo de acero
 esmaltado.
 Sacudidor de rejilla accionable
 desde el exterior.
 Tiradores cromados.
 Cabecera de fundición.



Cappuccino



-  378x817x417
-  56
-  190x165
-  240x405x235
-  BI-BW-CP
-  100 sup
-  Refrattario
-  115
-  kW-M 7,5
-  kW-N 4
-  % 53,5
-  1,8



Brown



Bianco

SERIE CUCINE

Le cucine a legna prodotte con i migliori materiali, realizzate con un design sobrio ed elegante in una gamma colori attuale e raffinata, sono uno splendido complemento d'arredo con cui riscoprire il piacere di cucinare.



COOKERS RANGE SERIES:
Made using top quality materials with a simple elegant design in a range of refined modern colours, the wood-fuelled kitchen ranges are a splendid interior design accessory to rediscover the pleasure of cooking.

SÉRIE CUISINIÈRES:
Les cuisinières à bois produites avec les meilleurs matériaux, réalisées avec un design sobre et élégant dans une gamme de couleurs actuelle et raffinée, constituent un splendide complément d'ameublement pour redécouvrir le plaisir de cuisiner.

SERIE KÜCHENHERDE:
Holzherde aus besten Materialien, im edlen und eleganten Design und mit aktueller und raffinierter Farbpalette, sind ein wunderbares Wohnaccessoire, das Sie die Freude am Kochen wieder entdecken lässt.

SERIE COCINAS:
Las cocinas a leña producidas con los mejores materiales, realizadas con un diseño sobrio y elegante en una gama de colores actuales y refinados, un magnífico complemento de decoración con los que redescubrir el placer de cocinar.





Di serie - Equiped with



Di serie - Equiped with

Rivestimento esterno in ghisa smaltata.
 Ampio focolare in ghisa-Nordiker™.
 Griglia fuoco in ghisa regolabile.
 Porta fuoco con doppio vetro.
 Grande forno smaltato da 80l.
 Telaio, piastra e cerchi in ghisa.
 Cassettoni portalegna con frontale in ghisa.

External covering in enameled cast-iron.
 Large cast iron hearth Nordiker™.
 Adjustable cast iron fire grate.
 Double glass fire door.
 Large enamelled oven 80l.
 Cast iron frame, plate and rings.
 Wood drawer with cast iron front.

Revêtement extérieur en fonte émaillée.
 Large foyer en fonte Nordiker™.
 Grille foyer à fonte réglable.
 Porte foyer avec double vitre.
 Grand foyer émaillé de 80 l.
 Châssis, plaque et cercles en fonte.
 Tiroir de rangement bois avec partie frontale en fonte.

Außenverkleidung aus emailliertem Gusseisen.
 Breite Feuerstelle aus Nordiker™-Gusseisen.
 Feuerrost aus einstellbarem Gusseisen.
 Feuerür mit Doppelglas.
 Großer emaillierter Ofen mit 80 l Inhalt.
 Rahmen, Platte und Ringe aus Gusseisen.
 Große Holzschublade mit Vorderseite aus Gusseisen.

Revestimiento externo de fundición esmaltada.
 Amplio hogar de fundición - Nordiker™.
 Rejilla de fuego de fundición regulable.
 Puerta con cristal doble.
 Horno gran esmaltado de 80 l.
 Bastidor, plancha y aros de fundición.
 Cajón gran para leña con frontal de fundición.



Crema Opaco



Nero



	1280x860x660		CMO-NE	kW-M	15,3	%	76
	321		160 s/p	kW-N	11,6		3,5
	300x405		Ghisa - Nordiker™	air-1	Si		
	400x410x460		Ghisa	air-2	Si		
	436x418x430		333	air-3	Si		



Suprema

Serie **Cucine a Legna**



Crema Opaco



Rivestimento esterno in ghisa smaltata.
Focolare in ghisa.
Porta fuoco con doppio vetro.
Grande forno smaltato da 80l.
Porte e piastra in ghisa.
Cassettoni portalegna con frontale in ghisa.

External covering in enameled cast-iron.
Cast iron hearth.
Double glass fire door.
Large enamelled oven 80l.
Cast iron doors and plate.
Wood drawer with cast iron front.

Revêtement extérieur en fonte émaillée.
Foyer en fonte.
Porte foyer avec double vitre.
Grand foyer émaillé de 80 l.
Portes et plaque en fonte.
Tiroir de rangement bois avec partie frontale en fonte.

Außenverkleidung aus emailiertem Gusseisen.
Feuerstelle aus Gusseisen.
Feuertür mit Doppelglas.
Großer emailierter Ofen mit 80 l Inhalt.
Türen und Platte aus Gusseisen.
Große Holzschublade mit Vorderseite aus Gusseisen.

Revestimiento externo de fundición esmaltada.
Hogar de fundición.
Puerta con cristal doble.
Horno gran esmaltado de 80 l.
Puertas y plancha de fundición.
Cajón gran para leña con frontal de fundición.



980x860x660

kg 220

235x225

277x304x460

436x418x430

CMO-NE

150 s/p

Ghisa

Ghisa

244

kW-M 10,9

kW-N 8,5

air-1 Si

air-2 Si

air-3 Si

% 78

2,6



Nero



Crema Opaco



Rivestimento esterno in ghisa smaltata.
Focolare in ghisa.
Griglia fuoco in ghisa.
Porta fuoco con doppio vetro.
Grande forno smaltato da 60l.
Porte e piastra in ghisa.
Cassettoni portalegna con frontale in ghisa.

External covering in enameled cast-iron.
Cast iron hearth.
Cast iron fire grate.
Double glass fire door.
Large enamelled oven 60l.
Cast iron doors and plate.
Wood drawer with cast iron front.

Revêtement extérieur en fonte émaillée.
Foyer en fonte.
Grille foyer en fonte.
Porte foyer avec double vitre.
Grand foyer émaillé de 60l.
Portes et plaque en fonte.
Tiroir de rangement bois avec partie frontale en fonte.

Außenverkleidung aus emailiertem Gusseisen.
Feuerstelle aus Gusseisen.
Feuerrost aus Gusseisen.
Feuertür mit Doppelglas.
Großer emailierter Ofen zu 60l.
Türen und Platte aus Gusseisen.
Große Holzschublade mit Vorderseite aus Gusseisen.

Revestimiento externo de fundición esmaltada.
Hogar de fundición.
Rejilla de fuego de fundición.
Puerta con cristal doble.
Horno gran esmaltado de 60 l.
Puertas y plancha de fundición.
Cajón gran para leña con frontal de fundición.



880x860x660

210

235x225

277x304x460

307x418x430

CMO-NE

150 s/p

Ghisa

Ghisa

249

kW-M 11,2

kW-N 8,7

air-1 Si

air-2 Si

air-3 Si

% 78

2,7



Nero



Silver



Rivestimento esterno in ghisa vetrificata.
Focolare in ghisa con sistema di post combustione.
Griglia fuoco in ghisa.
Porta fuoco con doppio vetro.
Forno smaltato panoramico.
Telaio, piastra e cerchi in ghisa.
Cassetto portalegna.

External covering in vitrified cast-iron.
Hearth in cast iron with post combustion system.
Cast iron fire grate.
double glass fire door.
panoramic enameled oven.
Cast iron frame, plate and rings wood drawer.

Revêtement extérieur en fonte vitrifiée.
Foyer en fonte avec système post combustion.
Grille foyer en fonte.
Porte foyer avec double vitre.
Four émaillé panoramique.
Châssis, plaque et cercles en fonte.
Tiroir de rangement bois.

Außenverkleidung aus verglastem Gusseisen.
Feuerraumverkleidung aus Gusseisen mit Doppelverbrennung.
Feuerrost aus Gusseisen.
Feuertür mit Doppelglas.
Panoramaofen emailliert.
Rahmen, Platte und Ringe aus Gusseisen.
Holzschublade.

Revestimiento externo de fundición vitrificada.
Hogar en fundición con sistema de post combustión.
Rejilla de fuego de fundición.
Puerta con cristal doble.
Horno panorámico esmaltado.
Bastidor, plancha y aros de fundición.
Cajón para la leña.



880x860x664

199

226x210

277x304x460

307x418x430

MA-SI

150 s/p

Ghisa

Ghisa

229

kW-M 10,3

kW-N 8

air-1 Si

air-2 Si

air-3 Si

% 77,5

2,4



Magnolia



Crema Opaco



Optional



Di serie - Equiped with

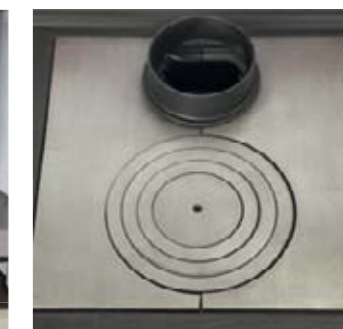

Rivestimento esterno in ghisa vetrificata.
Focolare in ghisa-Nordiker™.
Griglia fuoco in ghisa regolabile.
Porta fuoco con doppio vetro.
Telaio, piastra e cerchi in ghisa.
Cassettone portalegna con frontale in ghisa.

External facing in vitrified cast iron.
Cast iron hearth Nordiker™.
Adjustable cast iron fire grate.
Double glass fire door.
Cast iron frame, plate and rings.
Wood drawer with cast iron front.

Revêtement extérieur en fonte vitrifiée.
Foyer en fonte Nordiker™.
Grille foyer à fonte réglable.
Porte foyer avec double vitre.
Châssis, plaque et cercles en fonte.
Tiroir de rangement bois avec partie frontale en fonte.

Außenverkleidung aus verglastem Gusseisen.
Feuerstelle aus Nordiker™-Gusseisen.
Feuerrost aus einstellbarem Gusseisen.
Feuertür mit Doppelglas.
Rahmen, Platte und Ringe aus Gusseisen.
Große Holzschublade mit Vorderseite aus Gusseisen.

Revestimiento externo de fundición vitrificada.
Hogar de fundición - Nordiker™.
Rejilla de fuego de fundición regulable.
Puerta con cristal doble.
Bastidor, plancha y aros de fundición.
Cajón gran para leña con frontal de fundición.



682x860x653

197

405x325

423x346x475

CMO-NE

150 s/p

Ghisa / Nordiker™

Ghisa

261

kW-M 11,7

kW-N 9,1

air-1 Si

air-2 Si

air-3 Si

% 78

2,8

Optional Ø 120



Nero





Focolare in ghisa.
Rivestimento in cristallo e acciaio inox satinato.
Porta fuoco con doppio vetro.
Grande forno 60l.
Porte in cristallo.
Piastra in ghisa vetrificata e cerchi in ghisa levigata.
Possibilità di inserimento tra mobili.

Cast iron hearth.
Glass and brushed stainless steel finish.
Double glass fire door.
Large oven 60l.
Glass doors.
Polished cast iron plate and smooth cast iron rings.
Option of fitting between furniture cabinets.

Foyer en fonte.
Revêtement en cristal et en acier inox satiné.
Porte foyer avec double vitre.
Grand four 60 l.
Portes en cristal.
Plaque en fonte vitrifiée et cercles en fonte polie.
Possibilité d'introduction entre les meubles.

Feuerstelle aus Gusseisen.
Verkleidung aus Kristall und mattem Edelstahl.
Feuertür mit Doppelglas.
Großer Ofen 60 l.
Tür aus Kristall.
Platte aus verglastem Gusseisen und Ringe aus geschliffenem Gusseisen.
Zwischen den Möbeln einfügbar.

Hogar fundición.
Revestimiento de cristal y acero inoxidable satinado.
Puerta con cristal doble.
Horno gran 60 l.
Puertas de cristal.
Plancha de fundición vitrificada y aros de fundición pulida.
Posibilidad de colocarlo entre muebles.



	897x853x655		Inox (IN)	kW-M	8,7	%	81,9
	208		150 s/p	kW-N	7,1		2
	226x231		Ghisa - Nordiker™	air-1	Si		
	277x304x460		Ghisa	air-2	Si		
	307x400x430		203	air-3	Si		



Serie Cucine a Legna

Focolare in ghisa-nordiker™.
 Rivestimento in cristallo e acciaio
 inox satinato o smaltato.
 Porta fuoco con triplo vetro.
 Porta fuoco in ghisa.
 Forno di ampia dimensione con luce.
 Aria comburente BBC.
 Regolazione automatica dell'aria
 primaria.
 Piastra e cerchi in ghisa levigata.
 Porte reversibili.
 Possibilità di inserimento tra mobili.
 Altezza top 3 cm.

Hearth in cast-iron and nordiker™.
 Glass and brushed or enamelled
 stainless steel finish.
 Triple glass fire door.
 Cast iron fire door.
 Large oven with light.
 Combustion air BBC.
 Automatic adjustment of primary air.
 Top cooking plate and rings in
 polished cast-iron.
 Reversible doors.
 Option of fitting between furniture
 cabinets.
 Top thickness 3 cm.

Foyer en fonte nordiker™.
 Revêtement en cristal et en acier inox
 satiné ou émaillé.
 Porte foyer avec triple vitre.
 Porte foyer en fonte.
 Four de large dimension avec
 lumière.
 Air comburant BBC.
 Réglage automatique de l'air
 primaire.
 Plaque et cercles en fonte polie.
 Portes réversibles.
 Possibilité d'introduction entre les
 meubles.
 Épaisseur haut du poêle 3 cm.

Feuerstelle aus nordiker™-
 Gusseisen.
 Verkleidung aus Kristall und mat-
 tem Edelstahl oder emailliert.
 Feuertür mit Dreifachglas.
 Feuertür aus Gusseisen.
 Großer Ofen mit Beleuchtung.
 Verbrennungsluft BBC.
 Automatische Primärlufteinstellung.
 Platte und Ringe aus geschliffe-
 nem Gusseisen.
 Umkehrbare Türen.
 Zwischen den Möbeln einfügbar.
 Top - 3 cm dick.

Hogar de fundición-nordiker™.
 Revestimiento de cristal y acero
 inoxidable satinado o esmaltado.
 Puerta con vidrio triple.
 Puerta fuego de fundición.
 Horno de gran tamaño con luz.
 Aire comburente BBC.
 Regulación automática del aire
 primario.
 Plancha y aros de fundición pulida.
 Puertas reversibles.
 Posibilidad de colocarlo entre
 muebles.
 Altura parte de arriba cm.3.



Nero Antracite

Optional: altezza top 4 cm
 Optional: Top thickness 4 cm
 Optionnel: épaisseur haut du poêle 4 cm
 Optional: Top - 4 cm dick
 Opcional: parte de arriba altura cm.4

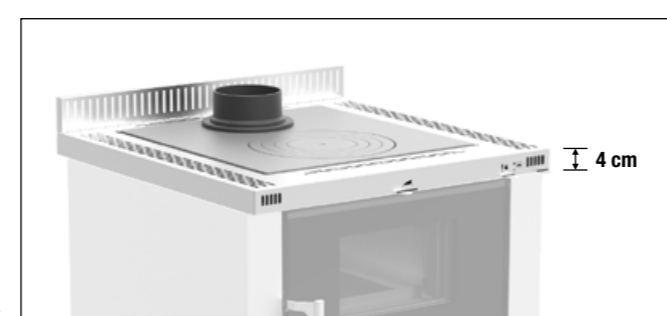

	600x850-910x600		IN-NE	kW-M	9,4	%	79
	131		120 S/P - Lat. Dx/Sx	kW-N	7,4		2,6
	225x160		Ghisa-Nordiker	air-1	SI	W	25
	220x147x337		Acciaio	air-2	SI		0 100
	350x175x410		212	air-3	SI		

Information icons:



Focolare in ghisa-nordiker™.
 Rivestimento in cristallo e acciaio inox satinato o smaltato.
 Porta fuoco con triplo vetro.
 Porta fuoco in ghisa.
 Forno di ampia dimensione con luce.
 Aria comburente BBC.
 Regolazione automatica dell'aria primaria.
 Piastra e cerchi in ghisa levigata.
 Porte reversibili.
 Possibilità di inserimento tra mobili.
 Altezza top 3 cm.

Feuerstelle aus Nordiker™-Gusseisen.
 Verkleidung aus Kristall und mattem Edelstahl oder emailliert.
 Feuertür mit Dreifachglas.
 Feuertür aus Gusseisen.
 Großer Ofen mit Beleuchtung.
 Verbrennungsluft BBC.
 Automatische Primärlufteinstellung.
 Platte und Ringe aus geschliffenem Gusseisen.
 Umkehrbare Türen.
 Zwischen den Möbeln einfügbar.
 Top - 3 cm dick.

Hearth in cast-iron and nordiker™.
 Glass and brushed or enamelled stainless steel finish.
 Triple glass fire door.
 Cast iron fire door.
 Large oven with light.
 Combustion air BBC.
 Automatic adjustment of primary air.
 Top cooking plate and rings in polished cast-iron.
 Reversible doors.
 Option of fitting between furniture cabinets.
 Top thickness 3 cm.

Hogar de fundición-nordiker™.
 Revestimiento de cristal y acero inoxidable satinado o esmaltado.
 Puerta con vidrio triple.
 Puerta fuego de fundición.
 Horno de gran tamaño con luz.
 Aire comburente BBC.
 Regulación automática del aire primario.
 Plancha y aros de fundición pulida.
 Puertas reversibles.
 Posibilidad de colocarlo entre muebles.
 Altura parte de arriba cm.3.

Foyer en fonte nordiker™.
 Revêtement en cristal et en acier inox satiné ou émaillé.
 Porte foyer avec triple vitre.
 Porte foyer en fonte.
 Four de large dimension avec lumière.
 Air comburant BBC.
 Réglage automatique de l'air primaire.
 Plaque et cercles en fonte polie.
 Portes réversibles.
 Possibilité d'introduction entre les meubles.
 épaisseur haut du poêle 3 cm.



Nero Antracite

↓	800X850-910X600	IN-NE	kW-M	10,2	%	78,4	
kg	161	∅	150 S/P - Lat. Dx/Sx	kW-N	8,0	⌚	2,4
⌚	225X160	🔥	Ghisa-Nordiker	air-1	SI	W	25
📦	220X147X337	🔥	Acciaio	air-2	SI	🏠	Ø 100
📦	430X320X430	🏠	229	air-3	SI		



Optional: altezza top 4 cm
 Optional: Top thickness 4 cm
 Optionnel: épaisseur haut du poêle 4 cm
 Opcional: parte de arriba altura cm.4



Focolare in ghisa-nordiker™.
 Rivestimento in cristallo e acciaio
 inox satinato o smaltato.
 Porta fuoco con doppio vetro.
 Porta fuoco in ghisa.
 Facciata in ghisa.
 Forno di ampia dimensione con luce.
 Aria comburente BBC.
 Regolazione automatica dell'aria
 primaria.
 Piastra e cerchi in ghisa levigata.
 Possibilità di inserimento tra mobili.
 Altezza top 3 cm.

Hearth in cast-iron and nordiker™.
 Glass and brushed or enamelled
 stainless steel finish.
 triple glass fire door.
 Cast iron fire door.
 Cast iron facade.
 Large oven with light.
 Combustion air BBC.
 Automatic adjustment of primary air.
 Top cooking plate and rings in
 polished cast-iron.
 Option of fitting between furniture
 cabinets.
 Top thickness 3 cm.

Foyer en fonte nordiker™.
 Revêtement en cristal et en acier
 inox satiné ou émaillé.
 Porte foyer avec triple vitre.
 Porte foyer en fonte.
 Façade en fonte.
 Four de large dimension avec
 lumière.
 Air comburant BBC.
 Réglage automatique de l'air primaire.
 Plaque et cercles en fonte polie.
 Possibilité d'introduction entre les
 meubles.
 Épaisseur haut du poêle 3 cm.

Feuerstelle aus Nordiker™
 Gusseisen.
 Verkleidung aus Kristall und mat-
 tem Edelstahl oder emailiert.
 Feuertür mit Dreifachglas.
 Feuertür aus Gusseisen.
 Ansichtsseite aus Gusseisen.
 Großer Ofen mit Beleuchtung.
 Verbrennungsluft BBC.
 Automatische Primärlufteinstellung.
 Platte und Ringe aus geschliffe-
 nem Gusseisen.
 Zwischen den Möbeln einfügbar.
 Top - 3 cm dick.

Hogar de fundición-nordiker™.
 Revestimiento de cristal y acero
 inoxidable satinado o esmaltado.
 Puerta con vidrio triple.
 Puerta fuego de fundición.
 Frontal de fundición.
 Horno de gran tamaño con luz.
 Aire comburente BBC.
 Regulación automática del aire
 primario.
 Plancha y aros de fundición pulida.
 Posibilidad de colocarlo entre
 muebles.
 Altura parte de arriba cm.3.



Nero Antracite

↓	900x850-910x600	IN-NE	kW-M	10,7**	%	75**
kg	174	150 s/p - Lat. Dx	kW-N	8**	⌚	2,5**
📏	210x175	Ghisa-Nordiker	air-1	SI	W	25
📏	226x270x384	Ghisa	air-2	SI	🔌	0 100
📏	310x286x410	229**	air-3	SI		



Optional: altezza top 4 cm
 Optional: Top thickness 4 cm
 Optionnel: épaisseur haut du poêle 4 cm
 Optional: Top - 4 cm dick
 Opcional: parte de arriba altura cm.4

** In fase di omologazione - Approval in progress - Certification en cours - Prüfung im Lauf - En proceso de homologación

Rosa XXL

Serie **Cucine a Legna**



Nero Antracite



Rivestimento esterno in acciaio porcellanato
 Porte e facciata in ghisa vetrificata
 Porta fuoco con doppio vetro
 Grande forno smaltato da 80l
 Piastra e cerchi in ghisa levigata
 Focolare in refrattario
 Cassettoni porta legna

Porcelain steel external facing
 Doors and facade in polished cast iron double glass fire door
 Large enamelled oven 80l
 top cooking plate and rings in polished cast-iron
 Refractory hearth
 wood drawer

Revêtement extérieur en acier porcelainé
 Portes et façade en fonte vitrifiée
 Porte foyer avec double vitre
 Grand foyer émaillé de 80 l
 Plaque et cercles en fonte polie
 Foyer en réfractaire
 Tiroir de rangement bois

Außenverkleidung aus porzellan-
 emailliertem Stahl
 Türen und Ansichtseite aus
 verglastem Gusseisen
 Feuertür mit Doppelglas
 Großer emaillierter Ofen mit 80 l
 Inhalt
 Platte und Ringe aus geschliffenem
 Gusseisen
 Feuerstelle aus Schamottstein
 Große Holzschublade

Revestimiento externo de acero
 porcelanado
 Puertas y frontal de fundición
 vitrificada
 Puerta con cristal doble
 Horno gran esmaltado de 80 l
 Plancha y aros de fundición pulida
 Hogar de refractario
 Cajón gran para la leña



1074x861x669

202

225x210

296x306x460

436x418x430

NE

150 s/p

Ghisa/Refrattario

Ghisa

244

kW-M 10

kW-N 8,5

air-1 Si

air-2 Si

air-3 Si

% 85

2,3



Rivestimento esterno in maiolica
Forno smaltato panoramico
Telaio in ghisa vetrificata
Piastra e cerchi in ghisa levigata
Ampio focolare in ghisa
Sistema di post-combustione

External facing in majolica
Panoramic enameled oven
Vitrified cast-iron top frame
Top cooking plate and rings in polished cast-iron
Large cast iron hearth
Post-combustion system

Revêtement extérieur en faïence
Four émaillé panoramique
Châssis en fonte vitrifiée
Plaque et cercles en fonte polie
Large foyer en fonte
Système de post-combustion

Äußere Verkleidung aus Majolika
Panoramaofen emailliert
Rahmen aus verglastem Gusseisen
Platte und Ringe aus geschliffenem Gusseisen
Breite Feuerstelle aus Gusseisen
Nachverbrennungsanlage

Revestimiento exterior de mayólica
Horno panorámico esmaltado
Bastidor de fundición vitrificada
Plancha y aros de fundición pulida
Amplio hogar de fundición
Sistema de post-combustión



Liberty Bordeaux



Liberty Pergamena

↓ 1030x851x666

kg 183

349X235

374x290x320

245x300x384

B0-PE

150 s/p

Ghisa

Acciaio

232

kW-M 10,0

kW-N 8,1



air-1 Si

air-2 Si

air-3 Si

% 81,1



PCS



CGC



RDT



BBC

2,3

100

Rosa Liberty

Serie **Cucine a Legna**

Liberty Pergamena



Rivestimento in maiolica.
Focolare interamente in ghisa.
Porta fuoco panoramica con vetro ceramico.
Forno smaltato panoramico.
Telaio, piastra e cerchi in ghisa.
Cassettoni portalegna.

External facing in majolica.
Solid cast iron hearth.
Panoramic fire door with ceramic glass.
Panoramic enameled oven.
Cast iron frame, plate and rings.
Wood drawer.

Revêtement extérieur en faïence
Foyer entièrement en fonte.
Porte foyer panoramique avec vitre céramique.
Four émaillé panoramique.
Châssis, plaque et cercles en fonte.
Tiroir de rangement bois.

Äußere Verkleidung aus Majolika
Feuerstelle vollständig aus Gusseisen.
Panoramafeuertür mit Glaskeramik.
Panoramaofen emailliert.
Rahmen, Platte und Ringe aus Gusseisen.
Große Holzschublade.

Revestimiento exterior de mayólica.
Hogar completamente de fundición.
Puerta fuego panorámica con cristal cerámico.
Horno panorámico esmaltado.
Bastidor, plancha y aros de fundición.
Cajón gran para la leña.



1030x851x666

178 kg

223x265

270x340x400

330x298x410

BO-PE

150 s/p

Ghisa

Acciaio

185 m³

8,2 kW-M

6,5 kW-N

Si air-1

Si air-2

78,9 %

1,9



Liberty Bordeaux



Kit griglia mobile optional

Rivestimento in maiolica.
Focolare interamente in ghisa.
Porta fuoco panoramica con vetro
ceramico.
Forno smaltato panoramico.
Telaio, piastra e cerchi in ghisa.
Cassettoni portalegna.

External facing in majolica.
Solid cast iron hearth.
Panoramic fire door with ceramic
glass.
Panoramic enameled oven.
Cast iron frame, plate and rings.
Wood drawer.

Revêtement extérieur en faïence
Foyer entièrement en fonte.
Porte foyer panoramique avec vitre
céramique.
Four émaillé panoramique.
Châssis, plaque et cercles en fonte.
Tiroir de rangement bois.

Äußere Verkleidung aus Majolika
Feuerstelle vollständig aus
Gusseisen.
Panoramafeuertür mit Glaskeramik.
Panoramaofen emailliert.
Rahmen, Platte und Ringe aus
gusseisen.
Große Holzschublade.

Revestimiento exterior de mayólica.
Hogar completamente de fundición.
Puerta fuego panorámica con cristal
cerámico.
Horno panorámico esmaltado.
Bastidor, plancha y aros de fundición.
Cajón gran para la leña.



Bordeaux



Cappuccino



Bianco Infinity

↓ 1030x851x666

kg 196

223x265

270x340x400

330x298x410

B0-CP-BIN

150 s/p

Ghisa

Acciaio

185

kW-M 8,2

kW-N 6,5



air-1 Si



air-2 Si



% 78,9



1,9



Pietra Naturale



Kit griglia mobile optional



Rivestimento in maiolica o pietra naturale.
Focolare interamente in ghisa.
Porta fuoco panoramica con vetro ceramico.
Forno smaltato panoramico.
Telaio, piastra e cerchi in ghisa.
Cassettoni portalegna.

External facing in majolica or in natural stone.
Solid cast iron hearth.
Panoramic fire door with ceramic glass.
Panoramic enameled oven.
Cast iron frame, plate and rings.
Wood drawer.

Revêtement en faïence ou en pierre.
Foyer entièrement en fonte.
Porte foyer panoramique avec vitre céramique.
Four émaillé panoramique.
Châssis, plaque et cercles en fonte.
Tiroir de rangement bois.

Verkleidung aus Majolika oder Naturstein.
Feuerstelle vollständig aus Gusseisen.
Panoramafeuertür mit Glaskeramik.
Panoramaofen emailliert.
Rahmen, Platte und Ringe aus Gusseisen.
Große Holzschublade.

Revestimiento de mayólica o piedra natural.
Hogar completamente de fundición.
Puerta fuego panorámica con cristal cerámico.
Horno panorámico esmaltado.
Bastidor, plancha y aros de fundición.
Cajón gran para la leña.



1030x851x666

197

223x265

270x340x400

330x298x410

PT

150 s/p

Ghisa

Acciaio

185

kW-M 8,2

kW-N 6,5

air-1 Si

air-2 Si

% 78,9

1,9

Rosetta Maiolica

Serie **Cucine a Legna**



Bordeaux



Kit griglia mobile optional

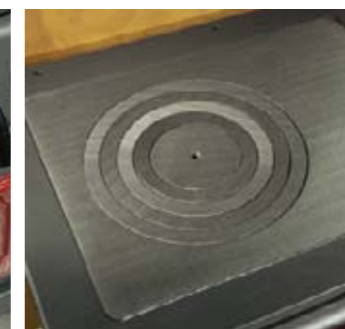

Rivestimento in maiolica.
Focolare interamente in ghisa.
Porta fuoco panoramica con vetro ceramico.
Forno smaltato panoramico.
Telaio, piastra e cerchi in ghisa.
Cassettoni portalegna.

External facing in majolica.
Solid cast iron hearth.
Panoramic fire door with ceramic glass.
Panoramic enameled oven.
Cast iron frame, plate and rings.
Wood drawer.

Revêtement extérieur en faïence.
Foyer entièrement en fonte.
Porte foyer panoramique avec vitre céramique.
Four émaillé panoramique.
Châssis, plaque et cercles en fonte.
Tiroir de rangement bois.

Äußere Verkleidung aus Majolika.
Feuerstelle vollkommen aus Gusseisen.
Panoramafeuertür mit Glaskeramik.
Panoramaofen emailliert.
Rahmen, Platte und Ringe aus Gusseisen.
Große Holzschublade.

Revestimiento exterior de mayólica.
Hogar completamente de fundición.
Puerta fuego panorámica con cristal cerámico.
Horno panorámico esmaltado.
Bastidor, plancha y aros de fundición.
Cajón gran para la leña.



869x843x572

169

209x265

230x350x382

245x300x384

BO-CP

130 s/p

Ghisa

Acciaio

206

kW-M 8,8

kW-N 7,2

air-1 Si

air-2 Si

air-3 Si

% 82

2,0



Cappuccino





Liberty Bordeaux



Kit griglia mobile optional



Rivestimento in maiolica o pietra naturale.
Focolare interamente in ghisa.
Porta fuoco panoramica con vetro ceramico.
Forno smaltato panoramico.
Telaio, piastra e cerchi in ghisa.
Cassettoni portalegna.

External facing in majolica or in natural stone.
Solid cast iron hearth.
Panoramic fire door with ceramic glass.
Panoramic enameled oven.
Cast iron frame, plate and rings.
Wood drawer.

Revêtement en faïence ou en pierre.
Foyer entièrement en fonte.
Porte foyer panoramique avec vitre céramique.
Four émaillé panoramique.
Châssis, plaque et cercles en fonte.
Tiroir de rangement bois.

Verkleidung aus Majolika oder Naturstein.
Feuerstelle vollkommen aus Gusseisen.
Panoramafeuertür mit Glaskeramik.
Panoramaofen emailliert.
Rahmen, Platte und Ringe aus Gusseisen.
Große Holzschublade.

Revestimiento de mayólica o piedra natural.
Hogar completamente de fundición.
Puerta fuego panorámica con cristal cerámico.
Horno panorámico esmaltado.
Bastidor, plancha y aros de fundición.
Cajón gran para la leña.



869x843x572	245x300x384	Acciaio	air-1 Si
153 - mod. PT 167	BO-PE-PT	206	air-2 Si
209x265	130 s/p	kW-M 8,8	air-3 Si
230x350x382	Ghisa	kW-N 7,2	% 82
			2,0



Liberty Pergamena



Pietra Naturale

Sovrana Evo

Serie **Cucine a Legna**

Nero Antracite

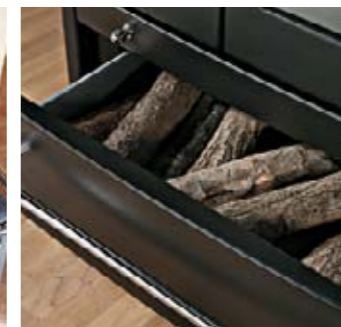

Rivestimento esterno in acciaio porcellanato.
Fianchi a convezione termica.
Forno smaltato con doppio vetro.
Cassetto scaldavivande.
Telaio, piastra e cerchi in ghisa.
Facciata e focolare in ghisa.
Cassettone portalegna.
Telaio in ghisa vetrificata.

Porcelain steel external facing.
Thermal convection flanks.
Enamelled oven with double glass.
Warming drawer.
Cast iron frame, plate and rings.
Cast iron facade and hearth.
Wood drawer.
Vitrified cast-iron top frame.

Revêtement extérieur en acier porcelainé.
Côtés à convection thermique.
Four émaillé avec double vitre.
Tiroir pour réchauffer les aliments.
Châssis, plaque et cercles en fonte.
Façade et foyer en fonte.
Tiroir de rangement bois.
Châssis en fonte vitrifiée.

Außenverkleidung aus porzellan-
emalliertem Stahl.
Seiten mit Wärmekonvektion.
Emaillierter Ofen mit Doppelglas.
Behälter zum Warmhalten von
Lebensmitteln.
Rahmen, Platte und Ringe aus
gusseisen.
Ansichtsseite und Feuerstelle aus
Gusseisen.
Große Holzschublade.
Rahmen aus verglastem Gusseisen.

Revestimiento externo de acero
porcelanado.
Laterales de convección térmica.
Horno esmaltado con cristal doble.
Cajón calentaplatos.
Bastidor, plancha y aros de fundición.
Frontal y hogar de fundición.
Cajón gran para la leña.
Bastidor de fundición vitrificada.



Marrone Sfumato



Cappuccino



Bianco

964x848x641	330x295x415	Ghisa	air-1 Si	2,8		
135	BI-CP-MF-NE	258	air-2 Si			
217x190	130 s/p	11,8	air-3 Si			
220x220x400	Ghisa	9	% 76			

Sovrana Easy

Serie **Cucine a Legna**



Rivestimento esterno in acciaio porcellanato
Focolare in ghisa con sistema di post combustione
Griglia fuoco in ghisa
Porta fuoco con doppio vetro
Forno smaltato panoramico
Telaio, piastra e cerchi in ghisa
Cassetto porta legna
Coperchio optional

Porcelain steel external facing
Hearth in cast iron with post combustion system.
Cast iron fire grate
double glass fire door
panoramic enameled oven
Cast iron frame, plate and rings
wood drawer
Optional cover

Revêtement extérieur en acier porcelainé
Foyer en fonte avec système post combustion
Grille foyer en fonte
Porte foyer avec double vitre
Four émaillé panoramique
Châssis, plaque et cercles en fonte
Tiroir de rangement bois
Couvercle optionnel

Außenverkleidung aus porzellan-emailliertem Stahl
Feuerraumverkleidung aus Gusseisen mit Doppelverbrennung
Feuerrost aus Gusseisen
Feuertür mit Doppelglas
Panoramaofen emailliert
Rahmen, Platte und Ringe aus gusseisen
Holzschublade
Optionale Abdeckplatte

Revestimiento externo de acero porcelanado
Hogar en fundición con sistema de post combustión
Rejilla de fuego de fundición
Puerta con cristal doble
Horno panorámico esmaltado
Bastidor, plancha y aros de fundición
Cajón para la leña
Tapa opcional



964x848x641	330x295x415	Ghisa	air-1 Si
133	NE-BI-CP	186	air-2 Si
217x190	130 s/p	kW-M 8,3	% 78,7
220x200x400	Ghisa	kW-N 6,5	1,9



Cappuccino



Bianco



Kit vasca inox optional

Rivestimento esterno in acciaio porcellanato.
Focolare interamente in ghisa.
Forno smaltato con doppio vetro.
Telaio in ghisa vetrificata.
Piastra e cerchi in ghisa levigata.

Porcelain steel external facing.
Solid cast iron hearth.
Enamelled oven with double glass.
Vitrified cast-iron top frame.
Top cooking plate and rings in polished cast-iron.

Revêtement extérieur en acier porcelainé.
Foyer entièrement en fonte.
Four émaillé avec double vitre.
Châssis en fonte vitrifiée.
Plaque et cercles en fonte polie.

Außenverkleidung aus porzellan-emailliertem Stahl.
Feuerstelle vollkommen aus Gusseisen.
Emaillierter Ofen mit Doppelglas.
Rahmen aus verglastem Gusseisen.
Platte und Ringe aus geschliffenem Gusseisen.

Revestimiento externo de acero porcelanado.
Hogar completamente de fundición.
Horno esmaltado con cristal doble.
Bastidor de fundición vitrificada.
Plancha y aros de fundición pulida.



Rustic



Romantica SX Bianco



Romantica SX Marrone Sfumato



Nero Antracite



Bianco



Cappuccino



Marrone Sfumato

Romantica 3,5

	877x856x568		Ghisa
	79		Acciaio
	150x140		143
	190x150x340	kW-M	6,6
	258x232x368	kW-N	5
	sx BI-MF	%	76
	dx BI-MF-NE-CP		1,4
	120 sup		

Romantica 4,5

	968x860x620		Ghisa
	90		Acciaio
	190x170		172
	190x180x375	kW-M	9,1
	300x230x405	kW-N	6
	sx BI-MF	%	66
	dx BI-MF-NE-CP-RU		1,8
	130 sup		



SERIE TERMOPRODOTTI

Le termocucine e termostufe "La Nordica", progettate e realizzate con le più avanzate tecnologie, riscaldano tutta la casa con una ottima resa calorica un consumo contenuto di legna e nel completo rispetto dell'ambiente.



THERMOPRODUCT SERIES
"La Nordica" thermostoves and thermo cookers designed and produced using the most advanced technologies heat the whole home with excellent heat output, low wood consumption and total respect for the environment.

SÉRIE APPAREILS DE CHAUFFAGE:
Les cuisinières et poêles de chauffage "La Nordica" conçus et réalisés avec les technologies les plus modernes chauffent toute la maison avec un très bon rendement calorifique, une consommation réduite de bois et dans le respect total de l'environnement.

SERIE THERMOPRODUKTE:
Die mit den fortschrittlichsten Technologien entwickelten und hergestellten "La Nordica" Thermoherde und Thermoöfen versorgen das ganze Haus mit einer optimalen Wärmezufuhr, bei eingeschränktem Holzverbrauch und mit vollkommener Rücksicht auf die Umwelt.

SERIE TERMOPRODUCTOS:
Las termococinas y termoestufas "La Nordica" han sido proyectadas y realizadas con tecnologías de calefacción de vanguardia y calientan toda la casa con un excelente rendimiento calorífico, un bajo consumo de leña y dentro del más absoluto respeto por el medioambiente.



TermoRossella Plus Evo D.S.A.

Serie **Termo Prodotti**



Liberty Bordeaux



Rivestimento esterno in maiolica o pietra naturale.
Porta, testata e basamento in ghisa smaltata.
Cassetto portalegna estraibile aria primaria e secondaria regolabile, aria terziaria pretrata con sistema di post combustione.
Dispositivo di sicurezza D.S.A. incluso.
Vetro ceramico resistente fino a 750°.

External facing in majolica or in natural stone.
Enameled cast iron top, door and base.
Extractable wood drawer.
Adjustable primary and secondary air, preset tertiary air with post combustion system.
D.S.A. security device included.
Ceramic glass resistant up to 750°.

Revêtement extérieur en faïence ou en pierre.
Porte, élément supérieur et bâti en fonte émaillée.
Tiroir à bois amovible.
Air primaire et secondaire réglables, air tertiaire pré-calibrée avec système post combustion.
Dispositif de sécurité D.S.A. inclus.
Vitre céramique résistante à 750°.

Außenverkleidung aus Majolika oder Naturstein.
Tür, Kopf und Sockel aus emailiertem Gusseisen.
Herausziehbare Holzschublade.
Verstellbare primär und Sekundärluft, voraustarierte Tertiärluft mit Nachverbrennungssystem.
Sicherheitsvorrichtung D.S.A. inbegriffen.
Keramikglas bis 750° wärmebeständig.































Revestimiento externo de mayólica o piedra natural.
puerta, cabecera y base de fundición.
Cajón extraíble por la leña.
Aire primario y secundario regulable, aire terciario con sistema de postcombustion precalibrado.
Dispositivo de seguridad D.S.A. incluido.
Crystal cerámico resistente a 750°.



Pietra Naturale



Liberty Pergamena

 559x915x533	 366	 70°-75°	 Canna fumaria:		
 162 - mod. PT 175	 H ₂ O 8,5	 1" F Gas	 17-20		
 355x245	 4,3	air-1 Si	 5m / 4 m		
 307x242x345	 kW-M 15,4	air-2 Si	 220x220÷0220 250x250÷0250		
 B0-PE-PT	 kW-N 12,8	air-3 Si	 100		
 130 sup	 18,5 L	% 83	 1/2" M Gas		
 Acciaio	 bar 3	 3,6	 Optional Ø 100		

TermoRossella Plus Forno D.S.A.

Serie **Termo Prodotti**



Liberty Bordeaux



Rivestimento esterno in maiolica o pietra naturale.
 Porta, testata e basamento in ghisa smaltata.
 Cassetto portalegna estraibile.
 Forno smaltato panoramico.
 Aria primaria e secondaria regolabile, aria terziaria pretrata con sistema di post combustione.
 Dispositivo di sicurezza D.S.A. incluso.
 Vetro ceramico resistente fino a 750°.

External facing in majolica or in natural stone.
 Enameled cast iron top, door and base.
 Extractable wood drawer.
 Panoramic enameled oven.
 Adjustable primary and secondary air, preset tertiary air with post combustion system.
 D.S.A. security device included.
 Ceramic glass resistant up to 750°.

Revêtement extérieur en faïence ou en pierre.
 Porte, élément supérieur et bâti en fonte émaillée.
 Tiroir à bois amovible.
 Four émaillé panoramique.
 Air primaire et secondaire réglables, air tertiaire pré-calibrée avec système post combustion.
 dispositif de sécurité D.S.A. inclus.
 Vitre céramique résistante à 750°.

Außenverkleidung aus Majolika oder Naturstein.
 Tür, Kopf und Sockel aus emailliertem Gusseisen.
 Herausziehbare Holzschublade.
 Panoramaofen emailliert.
 Verstellbare primär und Sekundärluft, voraustarierte Tertiärluft mit Nachverbrennungssystem.
 Sicherheitsvorrichtung D.S.A. inbegriffen.
 Keramikglas bis 750° wärmebeständig.

Revestimiento externo de mayólica o piedra natural.
 Puerta, cabecera y base de fundición.
 Cajón extraíble por la leña.
 Horno panorámico esmaltado.
 Aire primario y secundario regulable, aire terciario con sistema de postcombustion precalibrado.
 Dispositivo de seguridad D.S.A. incluido.
 Crystal cerámico resistente a 750°.



Liberty Pergamena



Pietra Naturale

559x1359x533	Acciaio	70°-75°	Canna fumaria:		
218 - mod. PT 242	390	1" F Gas	17-20		
345x245	H ₂ O 10,5	air-1 Si	5m / 4 m		
307x318x345	kW 3	air-2 Si	220x220÷0220		
330x300x370	kW-M 16,6	air-3 Si	250x250÷0250		
BO-PE-PT	kW-N 13,5	% 81,1	100		
130 sup.	bar 3	3,9	1/2" M Gas		
			Optional Ø 120		



Cappuccino



Rivestimento esterno in maiolica.
Porta in ghisa smaltata.
Cassetto portalegna estraibile.
Aria primaria e secondaria regolabile,
aria terziaria pretrata con sistema
di post combustione.
Dispositivo di sicurezza D.S.A. incluso.
Vetro ceramico resistente fino a 750°.

External facing in majolica.
Enameled cast iron door.
Extractable wood drawer.
Adjustable primary and secondary
air, preset tertiary air with post
combustion system.
D.S.A. security device included.
Ceramic glass resistant up to 750°.

Revêtement extérieur en faïence.
Porte en fonte émaillée.
Tiroir à bois amovible.
Air primaire et secondaire
réglables, air tertiaire pré-calibrée
avec système post combustion.
Dispositif de sécurité D.S.A. inclus.
Vitre céramique résistante à 750°.

Äußere Verkleidung aus Majolika.
Tür aus emailiertem Gusseisen.
Herausziehbare Holzschublade.
Verstellbare primär und Sekundärluft,
voraustarierte Tertiärluft mit
Nachverbrennungssystem.
Sicherheitsvorrichtung D.S.A.
inbegriffen.
Keramikglas bis 750°
wärmebeständig.

Revestimiento exterior de mayólica.
Puerta de fundición esmaltada.
Cajón extraíble por la leña.
Aire primario y secundario regulable,
aire terciario con sistema de
postcombustion precalibrado.
Dispositivo de seguridad D.S.A.
incluido.
Crystal cerámico resistente a 750°.



Bordeaux

587x980x572	390	70°-75°	Canna fumaria:	
183	H ₂ O 10,5	1" F Gas	17-20	
355x245	3	air-1 Si	5m / 4 m	
307x245x345	kW-M 17,3	air-2 Si	220x220÷0220 250x250÷0250	
B0-CP	kW-N 13,5	air-3 Si	100	
130 sup.	18,5 L	% 78,2	1/2" M Gas	
Acciaio	bar 3	4	Optional Ø 120	

Serie **Termo Prodotti**



Rivestimento esterno in maiolica.
Porta in ghisa smaltata.
Cassetto portalegna estraibile.
Forno smaltato panoramico.
Aria primaria e secondaria regolabile,
aria terziaria pretrata con sistema
di post combustione.
Dispositivo di sicurezza D.S.A. incluso.
Vetro ceramico resistente fino a 750°.

External facing in majolica.
Enameled cast iron door.
Extractable wood drawer.
Panoramic enameled oven.
Adjustable primary and secondary
air, preset tertiary air with post
combustion system.
D.S.A. security device included.
Ceramic glass resistant up to 750°.

Revêtement extérieur en faïence.
Porte en fonte émaillée.
Tiroir à bois amovible.
Four émaillé panoramique.
Air primaire et secondaire réglables,
air tertiaire pré-calibrée avec
système post combustion.
Dispositif de sécurité D.S.A. inclus.
Vitre céramique résistante à 750°.

Äußere Verkleidung aus Majolika.
Tür aus emailliertem Gusseisen.
Herausziehbare Holzschublade.
Panoramaofen emailliert.
Verstellbare primär und Sekundärluft,
voraustarierte Tertiärluft mit
Nachverbrennungssystem.
Sicherheitsvorrichtung D.S.A.
inbegriffen.
Keramikglas bis 750°
wärmebeständig.

Revestimiento exterior de mayólica.
Puerta de fundición esmaltada.
Cajón extraíble por la leña.
Horno panorámico esmaltado.
Aire primario y secundario regulable,
aire terciario con sistema de
postcombustion precalibrado.
Dispositivo de seguridad D.S.A.
incluido.
Crystal cerámico resistente a 750°.



Bordeaux



Cappuccino

587x1423x572
254 kg
345x245
307x318x345
330x300x370
80-CP
130 sup

Acciaio
390
H₂O 10,5
3
kW-M 16,6
kW-N 13,5
18,5 L
bar 3

70°-75°
1" F Gas
air-1 Si
air-2 Si
air-3 Si
% 81,1
3,9

Canna fumaria:
17-20
5m / 4 m
220x220+0220
250x250+0250
100
1/2" M Gas
Optional Ø 120





Bordeaux

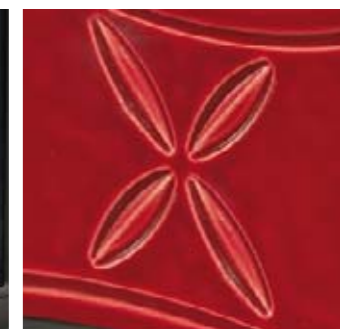

Rivestimento esterno in maiolica
Porta e piastra in ghisa vetrificata
Aria primaria e secondaria regolabile, aria terziaria pretrata con sistema di post combustione
Dispositivo di sicurezza D.S.A. incluso
Vetro ceramico resistente fino a 750°

Äußere Verkleidung aus Majolika
Tür und Platte aus verglastem Gusseisen
Verstellbare primär und Sekundärluft, voraustrierte Tertiärluft mit Nachverbrennungssystem
Sicherheitsvorrichtung D.S.A. inbegriffen
Keramikglas bis 750° wärmebeständig

External facing in majolica
Door and plate in polished cast iron
Adjustable primary and secondary air, preset tertiary air with post combustion system
D.S.A. security device included
Ceramic glass resistant up to 750°

Revestimiento exterior de mayólica
Puerta y placa de hierro fundido vitrificado
Aire primario y secundario regulable, aire terciario con sistema de postcombustion precalibrado
Dispositivo de seguridad D.S.A. Incluido
Crystal cerámico resistente a 750°

Revêtement extérieur en faïence
Porte et plaque en fonte vitrifiée
Air primaire et secondaire réglables, air tertiaire pré-calibrée avec système post combustion
Dispositif de sécurité D.S.A. inclus
Vitre céramique résistante à 750°

CONTO TERMICO

Per maggiori informazioni consultare il nostro sito:
www.lanordica-extraflame.com

Loriet D.S.A.

570x1258x567	688	70°-75°	Canna fumaria:
203	H ₂ O 14,5	1" F Gas	17-20
325x223	kW 9,4	air-1 Si	5m
330x300x345	kW-M 27,6	air-2 Si	220x220÷Ø220
B0	kW-N 24	air-3 Si	100
130 sup.	50 L	% 86,9	3/4" M Gas
Ghisa/Acciaio	bar 3	6,4	Ø 100



Loriet S D.S.A.

570x1258x567	481	70°-75°	Canna fumaria:
203	H ₂ O 10,5	1" F Gas	17-20
325x223	kW 6,2	air-1 Si	5m
330x300x345	kW-M 19,1	air-2 Si	220x220÷Ø220
B0	kW-N 16,8	air-3 Si	100
130 sup.	50 L	% 88	3/4" M Gas
Ghisa/Acciaio	bar 3	4,3	Ø 100





Ghisa smaltata

Stufa interamente in ghisa smaltata.
Porta di carica frontale.
Ghisa ad alto rendimento termico.
Aria primaria e secondaria regolabile,
aria terziaria prearata con sistema
di post combustione.
Dispositivo di sicurezza D.S.A. incluso.
Vetro ceramico resistente fino a 750°.

Stove made completely of
Enameled cast-iron.
Front loading door.
Very high thermic yield cast-iron.
Adjustable primary and secondary
air, preset tertiary air with post
combustion system.
D.S.A. security device included.
Ceramic glass resistant up to 750°.

Poêle entièrement en fonte émaillée.
Porte de chargement frontal.
Fonte à rendement thermique élevé.
air primaire et secondaire réglables,
air tertiaire pré-calibrée avec système
post combustion.
Dispositif de sécurité D.S.A. inclus.
Vitre céramique résistante à 750°.

Ofen vollständig aus emailiertem
Gusseisen.
Tür Frontbeschickung.
Gusseisen mit hoher Wärmeleistung.
Verstellbare primär und Sekundärluft,
voraustarierte Tertiärluft mit
Nachverbrennungssystem.
Sicherheitsvorrichtung D.S.A.
inbegriffen.
Keramikglas bis 750°
wärmebeständig.

Estufa completamente de fundición
esmaltada.
Puerta de carga frontal.
Fundición de alto rendimiento
térmico.
Aire primario y secundario regulable,
aire terciario con sistema de
postcombustion precalibrado.
Dispositivo de seguridad D.S.A.
incluido.
Crystal cerámico resistente a 750°.

760x775x520	430	70°-75°	Canna fumaria:			
212	H ₂ O 8,5	1" F Gas	17-20			
519x340	6,5	air-1 Si	5m / 4 m			
570x300x325	kW-M 19,1	air-2 Si	220x220÷Ø220			
150 sup.	kW-N 15	air-3 Si	250x250÷Ø250			
Ghisa/Nordiker™	14,5	% 78,4	100			
	bar 3	4,4	1/2" M Gas			

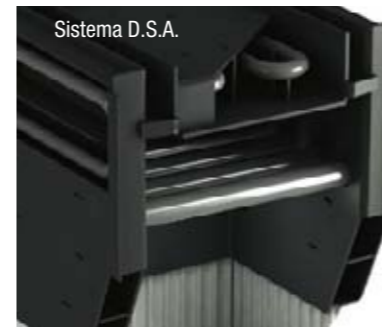



Rivestimento esterno in maiolica. Basamento, testata e porta in ghisa. Rivestimento interno del focolare in acciaio. Focolare a fiamma verticale. Aria primaria e secondaria regolabile, aria terziaria pretratarata con sistema di post combustione. Dispositivo di sicurezza D.S.A. incluso. Vetro ceramico resistente a 750° in pezzo unico.

External facing in majolica. Base, top and door in cast iron. Internal hearth covering in steel. Vertical flame hearth. Adjustable primary and secondary air, preset tertiary air with post combustion system. D.S.A. security device included. Ceramic glass heat-resistant 750°C in a single piece.

Revêtement extérieur en faïence. Bâti, élément supérieur et porte en fonte. Revêtement interne du foyer en acier. Foyer à flamme verticale. Air primaire et secondaire réglables, air tertiaire pré-calibrée avec système post combustion. Dispositif de sécurité D.S.A. inclus. Vitre céramique résistante à 750° C en une seule pièce.

Äußere Verkleidung aus Majolika. Sockel, Kopf und Tür aus Gusseisen. Innenverkleidung der Feuerstelle aus Stahl. Feuerstätte mit senkrechter Flamme. Verstellbare primär und Sekundärluft, voraustarierte Tertiärluft mit Nachverbrennungssystem. Sicherheitsvorrichtung D.S.A. inbegriffen. Glaskeramikfenster, hitzebeständig bis auf 750°C, an einem Stück.

Revestimiento exterior de mayólica. Base, cabecera y puerta de fundición. Revestimiento interno del hogar de acero. Hogar con llama vertical. Aire primario y secundario regulable, aire terciario con sistema de postcombustion precalibrado. Dispositivo de seguridad D.S.A. incluido. Cristal cerámico resistente hasta los 750° C en un bloque único.



Bordeaux



Pergamena



Titanio

720x1242x575	249	424x350	424x450x320	BO-PE-TI	160 sup	Acciaio	559	H ₂ O 14,9	4,6	kW-M 24,8	kW-N 19,5	40	bar 2,5	70°-75°C	1" F Gas	air-1 Si	air-2 Si	air-3 Si	% 78,6	5,8	Ø100	Canna fumaria:	17-20	5 m	220x220-Ø220	100	3/4" M Gas
--------------	-----	---------	-------------	----------	---------	---------	-----	-----------------------	-----	-----------	-----------	----	---------	----------	----------	----------	----------	----------	--------	-----	------	----------------	-------	-----	--------------	-----	------------





Rivestimento esterno in maiolica. Base, testata e porta in ghisa. Rivestimento interno del focolare in acciaio. Focolare a fiamma verticale. Aria primaria e secondaria regolabile, aria terziaria pretrata con sistema di post combustione. Dispositivo di sicurezza D.S.A. incluso. Vetro ceramico resistente a 750° in pezzo unico.

External facing in majolica. Base, top and door in cast iron. Internal hearth covering in steel. Vertical flame hearth. Adjustable primary and secondary air, preset tertiary air with post combustion system. D.S.A. security device included. Ceramic glass heat-resistant 750°C in a single piece.

Revêtement extérieur en faïence. Bâti, élément supérieur et porte en fonte. Revêtement interne du foyer en acier. Foyer à flamme verticale. Air primaire et secondaire réglables, air tertiaire pré-calibrée avec système post combustion. Dispositif de sécurité D.S.A. inclus. Vitre céramique résistante à 750° C en une seule pièce.

Äußere Verkleidung aus Majolika. Sockel, Kopf und Tür aus Gusseisen. Innenverkleidung der Feuerstelle aus Stahl. Feuerstätte mit senkrechter Flamme. Verstellbare primär und Sekundärluft, voraustarierte Tertiärluft mit Nachverbrennungssystem. Sicherheitsvorrichtung D.S.A. inbegriffen. Glaskeramikfenster, hitzebeständig bis auf 750°C, an einem Stück.

Revestimiento exterior de mayólica. Base, cabecera y puerta de fundición. Revestimiento interno del hogar de acero. Hogar con llama vertical. Aire primario y secundario regulable, aire terciario con sistema de postcombustion precalibrado. Dispositivo de seguridad D.S.A. incluido. Cristal cerámico resistente hasta los 750° C en un bloque único.



Titanio



Pergamena



Bordeaux

CONTO TERMICO

Per maggiori informazioni consultare il nostro sito: www.lanordica-extraflame.com

731x1246x634	501	70°-75°C	Ø100
245	H ₂ O 10,6	1" F Gas	
424x350	6,9	air-1 Si	Canna fumaria:
424x337x320	kW-M 20,5	air-2 Si	17-20
B0-PE-TI	kW-N 17,5	air-3 Si	5 m
160 sup	40	% 85,3	220x220-Ø220
Acciaio	bar 2,5	4,8	100
			3/4" M Gas





Bianco Infinity



Rivestimento esterno in maiolica.
 Basamento e porta in ghisa.
 Rivestimento interno del focolare in acciaio.
 Focolare a fiamma verticale.
 Aria primaria e secondaria regolabile, aria terziaria pretrata con sistema di post combustione.
 Dispositivo di sicurezza D.S.A. incluso.

Äußere Verkleidung aus Majolika.
 Sockel und Tür aus Gusseisen.
 Innenverkleidung der Feuerstelle aus Stahl.
 Feuerstätte mit senkrechter Flamme.
 Verstellbare primär und Sekundärluft, voraustrierte Tertiärluft mit Nachverbrennungssystem.
 Sicherheitsvorrichtung D.S.A. inbegriffen.



































Room ventilation.
 External facing in majolica.
 Base and door in cast iron.
 Internal hearth covering in steel.
 Vertical flame hearth.
 Adjustable primary and secondary air, preset tertiary air with post combustion system.
 D.S.A. security device included.

Revestimiento exterior de mayólica.
 Base y puerta de hierro fundido.
 Revestimiento interno del hogar de acero.
 Hogar con llama vertical.
 Aire primario y secundario regulable, aire terciario con sistema de postcombustion precalibrado.
 Dispositivo de seguridad D.S.A. incluido.

Revêtement extérieur en faïence.
 Bâti et porte en fonte.
 Revêtement interne du foyer en acier.
 Foyer à flamme verticale.
 Air primaire et secondaire réglables, air tertiaire pré-calibrée avec système post combustion.
 Dispositif de sécurité D.S.A. inclus.



Bordeaux

 766x1272x647	 501	 70°-75°	 Canna fumaria:	 TermoProdotti	 GGC
 227	 H ₂ O 10,6	 1" F Gas	 17-20	 PCS	 DSA
 424x350	 6,9	 air-1 Si	 5m	 BBC	 RDT
 424x337x320	 kW-M 20,5	 air-2 Si	 220x220÷0220	 CONTO TERMICO Per maggiori informazioni consultare il nostro sito: www.lanordica-extraflame.com	
 BIN-B0	 kW-N 17,5	 air-3 Si	 100		
 160 sup.	 40	 % 85,3	 3/4" M Gas		
 Acciaio	 bar 2,5	 4,8	 Ø100		

Norma Steel S Evo Idro D.S.A.

Serie **Termo Prodotti**



Bianco Infinity



Rivestimento esterno in acciaio verniciato e testata in maiolica. Basamento e porta in ghisa. Rivestimento interno del focolare in acciaio. Focolare a fiamma verticale. Aria primaria e secondaria regolabile, aria terziaria pretrata con sistema di post combustione. Dispositivo di sicurezza D.S.A. incluso.

Außenverkleidung aus lackiertem Stahl und obere Platte aus Majolika. Sockel und Tür aus Gusseisen. Innenverkleidung der Feuerstelle aus Stahl. Feuerstätte mit senkrechter Flamme. Verstellbare primär und Sekundärluft, voraustarierte Tertiärluft mit Nachverbrennungssystem. Sicherheitsvorrichtung D.S.A. inbegriffen.

External facing in painted steel and majolica. Base and door in cast iron. Internal hearth covering in steel. Vertical flame hearth. Adjustable primary and secondary air, preset tertiary air with post combustion system. D.S.A. security device included.

Revestimiento externo de acero barnizado y cabecera de mayólica. Base y puerta de hierro fundido. Revestimiento interno del hogar de acero. Hogar con llama vertical. Aire primario y secundario regulable, aire terciario con sistema de postcombustion precalibrado. Dispositivo de seguridad d.S.A. Incluido

Revêtement extérieure en acier peint et tête en majolique. Bâti et porte en fonte. Revêtement interne du foyer en acier. Foyer à flamme verticale. Air primaire et secondaire réglables, air tertiaire pré-calibrée avec système post combustion. Dispositif de sécurité D.S.A. inclus.

766x1272x647	204	424x350	424x337x320	BIN	160 Sup	Acciaio
501	H ₂ O 10,6	kW-M 6,9	kW-N 20,5	kW-N 17,5	40	bar 2,5
70°-75°	1" F Gas	air-1 Sì	air-2 Sì	air-3 Sì	% 85,3	4,8
Canna fumaria:	17-20	5m	220x220÷Ø220	100	3/4" M Gas	Ø100



CONTO TERMICO

Per maggiori informazioni consultare il nostro sito: www.lanordica-extraflame.com

Serie **Termo Prodotti**



Rivestimento esterno in maiolica o crystal.
Cassetto cenere estraibile.
Aria primaria e secondaria, regolabile, aria terziaria prearata con sistema di post combustione.
Dispositivo di sicurezza D.S.A. incluso.
Vetro ceramico resistente fino a 750°.

External surround in crystal or mayolica.
Extractable ash drawer.
Adjustable primary and secondary air, preset tertiary air with post combustion system.
D.S.A. security device included.
Ceramic glass resistant up to 750°.

Revêtement extérieur en faïence ou en crystal.
Tiroir cendrier amovible.
Air primaire et secondaire réglables, air tertiaire pré-calibrée avec système post combustion.
Dispositif de sécurité D.S.A. inclus.
Vitre céramique résistante à 750°.

Außenverkleidung aus Majolika oder Kristall.
Herausziehbare Aschenlade.
Verstellbare primär und Sekundärluft, voraustarierte Tertiärluft mit Nachverbrennungssystem.
Sicherheitsvorrichtung D.S.A. inbegriffen.
Keramikglas bis 750° wärmebeständig.

Revestimiento externo de mayólica o cristal.
Cajón de cenizas extraíble.
Aire primario y secundario regulable, aire terciario con sistema de postcombustion precalibrado.
Dispositivo de seguridad D.S.A. incluido.
Crystal cerámico resistente a 750°.



Crystal



Bianco Infinity

	878x1076x565		441		70°-75°		Ø120			
	BIN: 252 / CRY: 219		H ₂ O 11,1		1" F Gas	Canna fumaria:				
	635x245		4,3		air-1 Si		17-20			
	590x320x350		kW-M 18,6		air-2 Si		5m / 4 m			
	BIN-CRY		kW-N 15,4		air-3 Si		220x220÷Ø220 250x250÷Ø250			
	160 sup		20		% 82,7		100			
	Ghisa-Nordiker™		bar 3		4,3		1/2" M Gas			



Nero

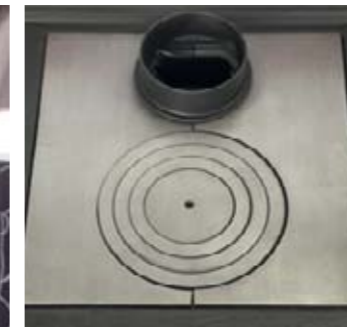

Rivestimento esterno in ghisa smaltata.
Telaio in ghisa vetrificata.
Piastra e cerchi in ghisa levigata.
Cassettoni portalegna.
Aria primaria e secondaria regolabile,
aria terziaria pretrata con sistema
di post combustione.
Dispositivo di sicurezza D.S.A. incluso.

External covering in enameled
cast-iron.
Vitrified cast-iron top frame.
Top cooking plate and rings in
polished cast-iron.
Wood drawer.
Adjustable primary and secondary
air, preset tertiary air with post
combustion system.
D.S.A. security device included.

Revêtement extérieur en fonte
émailée.
Châssis en fonte vitrifiée.
Plaque et cercles en fonte polie.
Tiroir de rangement bois.
Air primaire et secondaire réglables,
air tertiaire pré-calibrée avec système
post combustion.
Dispositif de sécurité D.S.A. inclus.

Außenverkleidung aus emailiertem
Gusseisen.
Rahmen aus verglastem Gusseisen.
Platte und Ringe aus geschliffenem
Gusseisen.
Große Holzschublade.
Verstellbare primär und Sekundärluft,
voraustarierte Tertiärluft mit
Nachverbrennungssystem.
Sicherheitsvorrichtung D.S.A.
inbegriffen.

Revestimiento externo de fundición
esmaltada.
Bastidor de fundición vitrificada.
Plancha y aros de fundición pulida.
Cajón gran para la leña.
Aire primario y secundario regulable,
aire terciario con sistema de
postcombustion precalibrado.
Dispositivo de seguridad D.S.A.
incluido.



Crema Opaco

	682x860x679		484		70°-75°		Canna fumaria:		
	205		H ₂ O 11,9		1" F Gas		17-20		GGC
	405x260		5		air-1 Si		5m		PCS
	415x275x475		kW-M 21,4		air-2 Si		220x220÷0220		DSA
	CMO-NE		kW-N 16,9		air-3 Si		100		BBC
	150 sup.		20,5		% 78,8		3/4" M Gas		RDT
	Acciaio		bar 3,0		4,9		Ø100		
	Ghisa								

Nero Antracite

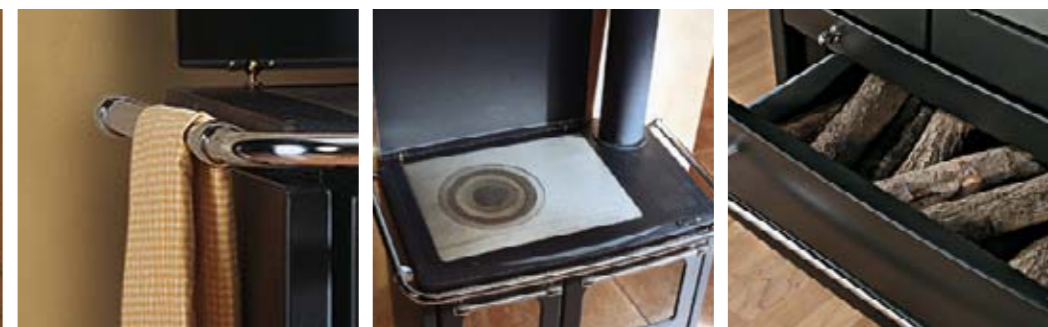

Rivestimento esterno in acciaio porcellanato.
Forno smaltato con doppio vetro.
Telaio in ghisa vetrificata.
Piastra e cerchi in ghisa levigata.
Fianchi a convezione termica.
Cassettoni portalegna.
Aria primaria e secondaria regolabile, aria terziaria pretrata con sistema di post combustione.
Dispositivo di sicurezza D.S.A. incluso.

Glazed steel external facing.
Panoramic enameled oven.
Vitrified cast-iron top frame.
Top cooking plate and rings in polished cast-iron.
Thermo convection sides.
Wood drawer.
Adjustable primary and secondary air, preset tertiary air with post combustion system.
D.S.A. security device included.

Revêtement extérieur en acier porcelainé.
Four émaillé avec double vitre.
Châssis en fonte vitrifiée.
Plaque et cercles en fonte polie côtés à convection thermique.
Tiroir de rangement bois.
Air primaire et secondaire réglables, air tertiaire pré-calibrée avec système post combustion.
Dispositif de sécurité D.S.A. inclus.

Außenverkleidung aus porzellan-emailliertem Stahl.
Emaillierter Ofen mit Doppelglas.
Rahmen aus verglastem Gusseisen.
Platte und Ringe aus geschliffenem Gusseisen.
Seiten mit Wärmekonvektion.
Große Holzschublade.
Verstellbare primär und Sekundärluft, vor-austarierte Tertiärluft mit Nachverbrennungssystem.
Sicherheitsvorrichtung D.S.A. inbegriffen.

Estufa completamente de fundición esmaltada.
Puerta de carga frontal.
Fundición de alto rendimiento térmico.
Aire primario y secundario regulable, aire terciario con sistema de postcombustion precalibrado.
Dispositivo de seguridad D.S.A. incluido.



964x889x640	Ghisa	70°-75°	Canna fumaria: 17-20 5m 220x220÷Ø220 100 1/2" M Gas
166	H ₂ O 9	1" F Gas	
217x172	kW-M 4,5	air-1 Si	
257x250x395	kW-N 13,5	air-2 Si	
330x300x410	kW-N 13,5	air-3 Si	
BI-MF-NE	kW-N 13,5	% 81,2	
130 s/p	bar 3	3,9	
Acciaio			



Marrone Sfumato



Bianco



Liberty Bordeaux

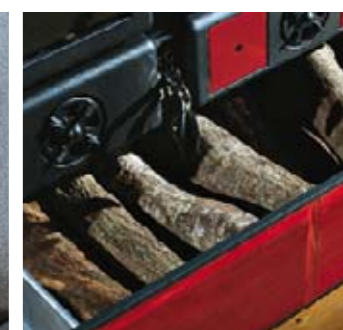
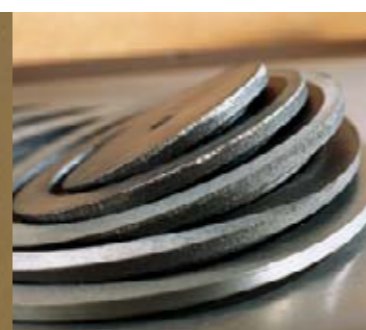

Rivestimento esterno in maiolica o pietra naturale.
Forno smaltato panoramico.
Telaio in ghisa vetrificata.
Piastra e cerchi in ghisa levigata.
Cassettoni portalegna.
Aria primaria e secondaria regolabile, aria terziaria prearata con sistema di post combustione.
Dispositivo di sicurezza D.S.A. incluso.

External facing in majolica or in natural stone.
Panoramic enameled oven.
Vitrified cast-iron top frame.
Top cooking plate and rings in polished cast-iron.
Wood drawer.
Adjustable primary and secondary air, preset tertiary air with post combustion system.
D.S.A. security device included.

Revêtement extérieur en faïence ou en pierre.
Four émaillé panoramique.
Châssis en fonte vitrifiée.
Plaque et cercles en fonte polie tiroir de rangement bois.
Air primaire et secondaire réglables, air tertiaire pré-calibrée avec système post combustion.
Dispositif de sécurité D.S.A. inclus.

Außenverkleidung aus Majolika oder Naturstein.
Panoramaofen emailliert.
Rahmen aus verglastem Gusseisen.
Platte und Ringe aus geschliffenem Gusseisen.
Große Holzschublade.
Verstellbare primär und Sekundärluft, voraustarierter Tertiärluft mit Nachverbrennungssystem.
Sicherheitsvorrichtung D.S.A. inbegriffen.

Revestimiento externo de mayólica o piedra natural.
Horno panorámico esmaltado.
Bastidor de fundición vitrificada.
Plancha y aros de fundición pulida.
Cajón gran para la leña.
Aire primario y secundario regulable, aire terciario con sistema de postcombustion precalibrado.
Dispositivo de seguridad D.S.A. incluido.

1017x852x662	Acciaio	70°-75°	Canna fumaria:
211 - mod. PT 226	444	1" F Gas	17-20
220x225	H ₂ O 9	air-1 Sì	5 m
265x285x400	kW-M 6,5	air-2 Sì	220x220÷Ø220
330x300x410	kW-N 15,5	air-3 Sì	100
PT-Liberty B0	14 L	% 79,9	1/2" M Gas
150 s/p	bar 3	4,5	
Acciaio			



Pietra Naturale



Rivestimento in maiolica o pietra naturale.
Forno smaltato panoramico.
Telaio in ghisa vetrificata.
Piastra e cerchi in ghisa levigata.
Aria primaria e secondaria regolabile, aria terziaria pretarata con sistema di post combustione.
Dispositivo di sicurezza D.S.A. incluso.
Centralina di controllo.

External facing in majolica or in natural stone.
Panoramic enameled oven.
Vitrified cast-iron top frame.
Top cooking plate and rings in polished cast-iron.
Adjustable primary and secondary air, preset tertiary air with post combustion system.
D.S.A. security device included.
Digital electronic control.

Revêtement en faïence ou en pierre.
Four émaillé panoramique.
Châssis en fonte vitrifiée.
Plaque et cercles en fonte polie.
Air primaire et secondaire réglables, air tertiaire pré-calibrée avec système post combustion.
Dispositif de sécurité D.S.A. inclus.
Centrale de contrôle.

Verkleidung aus Majolika oder Naturstein.
Panoramaofen emailliert.
Rahmen aus verglastem Gusseisen.
Platte und Ringe aus geschliffenem Gusseisen.
Verstellbare primär und Sekundärluft, vorjustierte Tertiärluft mit Nachverbrennungssystem.
Sicherheitsvorrichtung D.S.A. inbegriffen.
Steuereinheit.

Revestimiento de mayólica o piedra natural.
Horno panorámico esmaltado.
Bastidor de fundición vitrificada.
Plancha y aros de fundición pulida.
Aire primario y secundario regulable, aire terciario con sistema de postcombustion precalibrado.
Dispositivo de seguridad D.S.A. incluido.
Central de control.



Liberty Bordeaux



Pietra Naturale

1027x893x761	Acciaio	70°-75°	Canna fumaria:			
230 - mod. PT 245	447	air-1 Si	17-20			
220x225	H ₂ O 9,2	air-2 Si	5 m			
265x285x400	kW 6,4	air-3 Si	220x220÷Ø220			
330x300x410	kW-M 19,5	% 79,9				
PT- Liberty B0	kW-N 15,6	W 100				
150 s/p	14 L					
Acciaio	bar 3					

TermoRosa XXL D.S.A.

Serie Termo Prodotti



Nero Antracite



Rivestimento esterno in acciaio porcellanato
 Porte e facciata in ghisa vetrificata
 Porta fuoco con doppio vetro
 Grande forno smaltato da 60 l
 Piastra e cerchi in ghisa levigata
 Cassettoni porta legna
 Dispositivo di sicurezza D.S.A. incluso

Porcelain steel external facing
 Doors and facade in polished cast iron
 Double glass fire door
 Large enameled oven 60 l
 Top cooking plate and rings in polished cast-iron
 Wood drawer
 D.S.A. security device included

Revêtement extérieur en acier porcelainé
 Portes et façade en fonte vitrifiée
 Porte foyer avec double vitre
 Grand foyer émaillé de 60 l
 Plaque et cercles en fonte polie
 Tiroir de rangement bois
 Dispositif de sécurité D.S.A. inclus

Außenverkleidung aus porzellan-
 emailliertem Stahl
 Türen und Ansichtseite aus
 verglastem Gusseisen
 Feuertür mit Doppelglas
 Großer emaillierter Ofen mit 60 l
 Inhalt
 Platte und Ringe aus geschliffenem
 Gusseisen
 Große Holzschublade
 Sicherheitsvorrichtung D.S.A.
 inbegriffen

Revestimiento externo de acero
 porcelanado
 Puertas y frontal de fundición
 vitrificada
 Puerta con cristal doble
 Horno gran esmaltado de 60 l
 Plancha y aros de fundición pulida
 Cajón gran para la leña
 Dispositivo de seguridad D.S.A.
 incluido

1074x861x690
 275
 225x158
 257x350x405
 306x418x430
 NE
 160 s/p
 Acciaio

Ghisa
 527
 H₂O 15,1
 kW 3,3
 kW-M 22,2
 kW-N 18,4
 22
 bar 3

70°-75°
 1" F Gas
 air-1 Si
 air-2 Si
 air-3 Si
 % 83
 5,2

Canna fumaria:
 17-20
 5m
 220x220÷0220
 100
 1/2" M Gas



TermoRosa XXL Ready D.S.A. 2.0

Serie **Termo Prodotti**



Nero Antracite



Rivestimento esterno in acciaio porcellanato
 Porte e facciata in ghisa vetrificata
 Porta fuoco con doppio vetro
 Grande forno smaltato da 60 l
 Piastra e cerchi in ghisa levigata
 Dispositivo di sicurezza D.S.A. incluso
 Circuito idraulico a bordo

Porcelain steel external facing
 Doors and facade in polished cast iron
 Double glass fire door
 Large enamelled oven 60 l
 Top cooking plate and rings in polished cast-iron
 D.S.A. security device included
 Hydraulic circuit on board

Revêtement extérieur en acier porcelainé
 Portes et façade en fonte vitrifiée
 Porte foyer avec double vitre
 Grand foyer émaillé de 60 l
 Plaque et cercles en fonte polie
 Dispositif de sécurité D.S.A. inclus
 Circuit hydraulique à bord

Außenverkleidung aus porzellan-
 emailliertem Stahl
 Türen und Ansichtseite aus
 verglastem Gusseisen
 Feuertür mit Doppelglas
 Großer emaillierter Ofen mit 60 l
 Inhalt
 Platte und Ringe aus geschliffenem
 Gusseisen
 Sicherheitsvorrichtung D.S.A.
 inbegriffen
 Hydraulikkreislauf am Ofen

Revestimiento externo de acero
 porcelanado
 Puertas y frontal de fundición
 vitrificada
 Puerta con cristal doble
 Horno gran esmaltado de 60 l
 Plancha y aros de fundición pulida
 Dispositivo de seguridad D.S.A.
 incluido
 Circuito hidráulico a bordo



1074x876x782	Ghisa	70°-75°	
300	527	1" F Gas	
225x158	H ₂ O 15,1	air-1 Si	
257x350x405	kW 3,3	air-2 Si	
306x418x430	kW-M 22,2	air-3 Si	
NE	kW-N 18,4	% 83	
160 s/p	22	5,2	
Acciaio	bar 3	W 100	

Canna fumaria:

- 17-20
- 5m
- 220x220÷0220
- 100
- 1/2" M Gas

TermoSuprema Compact D.S.A.

Serie **Termo Prodotti**



Rivestimento esterno in ghisa smaltata.
Forno smaltato panoramico.
Telaio in ghisa vetrificata.
Piastra e cerchi in ghisa levigata.
Cassettoni portalegna.
Aria primaria e secondaria regolabile,
aria terziaria pretrata con sistema
di post combustione.
Dispositivo di sicurezza D.S.A. incluso.

External covering in enameled
cast-iron.
Panoramic enameled oven.
Vitrified cast-iron top frame.
Top cooking plate and rings in
polished cast-iron.
Wood drawer.
Adjustable primary and secondary
air, preset tertiary air with post
combustion system.
D.S.A. security device included.

Revêtement extérieur en fonte
émaillée.
Four émaillé panoramique.
Châssis en fonte vitrifiée.
Plaque et cercles en fonte polie.
Tiroir de rangement bois.
Air primaire et secondaire réglables,
air tertiaire pré-calibrée avec système
post combustion.
Dispositif de sécurité D.S.A. inclus.

Außenverkleidung aus emailiertem
Gusseisen.
Panoramaofen emailiert.
Rahmen aus verglastem Gusseisen.
Platte und Ringe aus geschliffenem
Gusseisen.
Große Holzschublade.
Verstellbare primär und Sekundärluft,
voraustarierte Tertiärluft mit
Nachverbrennungssystem.
Sicherheitsvorrichtung D.S.A.
inbegriffen.

Revestimiento externo de fundición
esmaltada.
Horno panorámico esmaltado.
Bastidor de fundición vitrificada.
Plancha y aros de fundición pulida.
Cajón gran para la leña.
Aire primario y secundario regulable,
aire terciario con sistema de
postcombustion precalibrado.
Dispositivo de seguridad D.S.A.
incluido.



Crema Opaco

982x860x682	Ghisa	70°-75°	Canna fumaria:
293	530	1" F Gas	17-20
233x160	H ₂ O 15	air-1 Si	5 m
257x350x407	kW 3,5	air-2 Si	220x220÷0220
307x418x430	kW-M 22,3	air-3 Si	100
CM0-NE	kW-N 18,5	% 83	1/2" M Gas
160 s/p	22 L	5,2	
Acciaio	bar 3		





Rivestimento esterno in cristallo e acciaio inox satinato.
Forno smaltato panoramico.
Telaio e piastra in ghisa vetrificata e cerchi in ghisa levigata.
Porta fuoco con doppio vetro.
Possibilità di inserimento tra mobili.
Aria primaria e secondaria regolabile, aria terziaria pretrata con sistema di post combustione.
Dispositivo di sicurezza D.S.A. incluso.

Crystal and polished stainless steel external facing.
Panoramic enameled oven.
Vitrified cast-iron top frame and plate and polished cast-iron rings.
Double glass fire door.
Possibility to fit between furniture.
Adjustable primary and secondary air, preset tertiary air with post combustion system.
D.S.A. security device included.

Revêtement extérieur en cristal et en acier inox satiné.
Four émaillé panoramique.
Châssis et plaque en fonte vitrifiée et cercles en fonte polie.
Porte foyer avec double vitre possibilité d'introduction entre les meubles.
Air primaire et secondaire réglables, air tertiaire pré-calibrée avec système post combustion.
Dispositif de sécurité D.S.A. inclus.

Verkleidung aus Kristall und mattem Edelstahl.
Panoramaofen emailiert.
Rahmen und Platte aus verglastem Gusseisen und Ringe aus geschliffenem Gusseisen.
Feuertür mit Doppelglas.
Zwischen den Möbeln einfügbar.
Verstellbare primär und Sekundärluft, vorastarierte Tertiärluft mit Nachverbrennungssystem.
Sicherheitsvorrichtung D.S.A. inbegriffen.

Revestimiento externo de cristal y acero inoxidable satinado.
Horno panorámico esmaltado.
Bastidor y plancha de fundición.
Vitrificada y aros de fundición pulida.
Puerta fuego con cristal doble.
Posibilidad de colocarla entre muebles.
Aire primario y secundario regulable, aire terciario con sistema de postcombustion precalibrado.
Dispositivo de seguridad D.S.A. incluido.

996x853x730	527	70°-75°	Canna fumaria:		CGC
283	H ₂ O 15,1	1" F Gas	17-20	DSA	PCS
233x160	kW 3,3	air-1 Si	5 m	RDT	
257x350x407	kW-M 22,2	air-2 Si	220x220÷Ø220		
307x418x430	kW-N 18,4	air-3 Si	100		
IN	22	% 83	1/2" M Gas		
160 s/p	bar 3	5,1			
Acciaio					



Rivestimento esterno in ghisa vetrificata.
Forno smaltato panoramico.
Telaio in ghisa vetrificata.
Piastra e cerchi in ghisa levigata.
Porta fuoco con doppio vetro.
Cassetto porta legna.
Aria primaria e secondaria regolabile, aria terziaria prearata con sistema di post combustione.
Dispositivo di sicurezza D.S.A. incluso.

External covering in vitrified cast-iron.
Panoramic enameled oven.
Vitrified cast-iron top frame.
Top cooking plate and rings in polished cast-iron.
Double glass fire door.
Wood drawer.
Adjustable primary and secondary air, preset tertiary air with post combustion system.
D.S.A. security device included.

Revêtement extérieur en fonte vitrifiée.
Four émaillé panoramique
Châssis en fonte vitrifiée
Plaque et cercles en fonte polie.
Porte foyer avec double vitre.
Tiroir de rangement bois.
Air primaire et secondaire réglables, air tertiaire pré-calibrée avec système post combustion.
Dispositif de sécurité D.S.A. inclus.

Außenverkleidung aus verglastem Gusseisen.
Panoramaofen emailiert.
Rahmen aus verglastem Gusseisen.
Platte und Ringe aus geschliffenem Gusseisen.
Feuertür mit Doppelglas.
Holzaufbewahrungskasten.
Verstellbare primär und Sekundärluft, voraustarierte Tertiärluft mit Nachverbrennungssystem.
Sicherheitsvorrichtung D.S.A. inbegriffen.





























Revestimiento externo de fundición vitrificada.
Horno panorámico esmaltado.
Bastidor de fundición vitrificada.
Plancha y aros de fundición pulida.
Puerta fuego con cristal doble.
Cajón gran para la leña.
Aire primario y secundario regulable, aire terciario con sistema de postcombustion precalibrado.
Dispositivo de seguridad D.S.A. incluido.





Magnolia





Silver

 965x861x690	 Ghisa	 70°-75°	 Canna fumaria:
 272	 530	 1" F Gas	 17-20
 233x160	 H ₂ O 15	 air-1 Si	 5 m
 257x350x407	 kW 3,5	 air-2 Si	 220x220÷Ø220
 307x418x430	 kW-M 22,3	 air-3 Si	 100
 MA-SI	 kW-N 18,5	 % 83	 1/2" M Gas
 160 s/p	 22 L	 5,2	
 Acciaio	 bar 3		

















Modulo All Inclusive Italy Termo D.S.A. 2.0

Serie **Termo Prodotti**

Modulo di collegamento all'impianto di riscaldamento idraulico per ITALY TERMO D.S.A. Il modulo è dotato di: sicurezze, vaso d'espansione, sistema di circolazione, sistema per la produzione di acqua sanitaria. La gestione del funzionamento è affidata ad un regolatore elettronico digitale sempre a bordo macchina.

Connection Set to the hydraulic heating system for ITALY TERMO D.S.A. The set is equipped with: safety valves, expansion vessel, circulating system, sanitary water production system. The operation is controlled by a digital electronic device, supplied with the appliance.

Module de branchement au système de chauffage hydraulique pour ITALY TERMO D.S.A. Le module est équipé avec: sécurités, vase d'expansion, système de circulation, système pour la production d'eau chaude sanitaire. La gestion du fonctionnement est réglée par un régulateur électronique digital qui est déjà fourni avec l'appareil.

Verbindungsmodul für die hydraulische Anlage des Modells Italy Termo D.S.A. Das Modul verfügt über: Sicherheitsventile, Ausdehnungsgefäß, Zirkulationssystem und Sanitärwarmwassersystem. Der Betrieb wird durch die ausgestattete elektronische bzw. digitale Steuerung geregelt.

Modulo de conexiòn al emplantado de calefacciòn idraulico ITALY TERMO D.S.A. El modulo se queda dotado de: seguridad, vaso de expansiòn, sistema de circulaciòn, sistema para la producciòn de agua sanitaria. El contròl de el aparato se queda guiada por un regulador electronico dijital situado a bordo maquina.



Magnolia



Silver



↓ 463x883x745

kg 106

SI-MA

W 100

Serie **Termo Prodotti**

Modulo All Inclusive Universale D.S.A. 2.0

Il modulo è dotato di: sicurezze, vaso d'espansione, sistema di circolazione, sistema per la produzione di acqua sanitaria. La gestione del funzionamento è affidata ad un regolatore elettronico digitale sempre a bordo macchina e dal display a controllo remoto (in dotazione).

The set is equipped with: safety valves, expansion vessel, circulating system, sanitary water production system. The operation is controlled by an on-board electronic device and a display with remote control (supplied with the appliance).

Le module est équipé avec: sécurités, vase d'expansion, système de circulation, système pour la production d'eau chaude sanitaire. La gestion du fonctionnement est réglée par un régulateur électronique digital qui est déjà fourni avec l'appareil et par le display à contrôle à distance (standard).

Das Modul verfügt über: Sicherheitsventile, Ausdehnungsgefäß, Zirkulationssystem und Sanitärwarmwassersystem. Der Betrieb wird durch eine elektronische bzw. digitale Steuerung an der Maschine und ein grafisches Display mit Fernkontrolle geregelt (serienmäßig).

El modulo está equipado con unos dispositivos de seguridad, deposito de expansión, sistema de circulación, sistema para la producción de agua sanitaria. El control del aparato viene hecho por un regulador electrónico digital siempre a bordo de la maquina y por el display con mando a distancia (incluido).



458x876x674
100 kg
NE
100 W



Collegabile con - Connectable with - Possibilità di branchement avec
- Verbindbar mit - Conectable con:



Nero Antracite

Con il Modulo All-Inclusive Universale diventa facile installare un termoprodotto.

All-Inclusive Modulo Universale makes a thermoproduct installation easier.

Avec le Module All-Inclusive Universale il devient facile d'installer un thermo-produit.

Mit dem Modulo All-Inclusive Universale wird es leicht, ein Thermoproduct zu installieren.

Con el Modulo All-Inclusive Universale la instalación de un termo producto se pone fácil.



TermoSovrana D.S.A.



TermoRosa D.S.A.



TermoRosa XXL D.S.A.



TermoSuprema Compact D.S.A.



Italy Termo Built-In D.S.A.



Italy Termo D.S.A.

TERMOCUCINE



TermoRossella Evo D.S.A.



TermoRossella Forno D.S.A.



TermoNicoletta D.S.A.



TermoNicoletta Forno D.S.A.



Loriet S D.S.A.



TermoSotta D.S.A.



Norma S Idro D.S.A.



Norma Classic S Evo Idro D.S.A.



Norma Steel S Evo Idro D.S.A.



Fly Idro D.S.A.



TermoCucinotta Evo D.S.A.

TERMOSTUFE



TermoCamino Base D.S.A.



Focolare Idro Crystal D.S.A.



TermoCamino WF25X D.S.A.



TermoCamino WF Plus D.S.A.

TERMOCAMINI

LA NORDICA-EXTRAFLAME, NELL'OTTICA DI ACCONTENTARE ANCHE I CLIENTI PIÙ ESIGENTI, HA ARRICCHITO I PROPRI PRODOTTI DI IMPORTANTI ACCESSORI.

La Nordica-Extraflame in order to satisfy even the most demanding customers has enhanced its product range with important accessories.

Dans le but de satisfaire aussi la clientèle plus exigeante, La Nordica-Extraflame a enrichi ses produits avec importants accessoires.

Um sogar ihre sehr wählerischen Kunden zufrieden zu stellen, hat La Nordica-Extraflame ihre Produkte um wichtige Zubehöre bereichert.

Con el fin de satisfacer también los clientes más exigentes, La Nordica-Extraflame ha enriquecido sus productos con unos importantes accesorios.

ACCESSORI IDRAULICI

Kit separatore impianto idraulico A/C 2.0
Water separator kit 2.0
Kit séparateur installation hydraulique A/C 2.0
Separator-Kit 2.0
Kit separador instalacion hydraulica A/C 2.0



Kit ACS assemblato semplice 2.0
Assembled ACS Kit 2.0
Kit ECS assemblé simple 2.0
Zusammengebautes ACS Kit für Sanitärwassererzeugung 2.0
Kit ACS montado simple 2.0



Kit ACS assemblato combinato 2.0
Assembled and combined ACS Kit 2.0
KIT ECS assemblé combiné 2.0
Zusammengebautes kombiniertes ACS Kit 2.0
Kit ACS montado assemblato combinado 2.0



Regolatore TermoProdotti Digitale
Controller for thermoproducts
Régulateur digitale Thermoproduits
Digitale Steuerung für Thermoprodukte
Regulador digital para Termo Productos



Scambiatore 20 piastre inox
20 Plate exchanger inox
Echangeur 20 plaques inox
20 Platten-Wärmetauscher inox
Intercambiador 20 placas inox



Scambiatore 30 piastre inox
30 Plate Exchange inox
Echangeur 30 plaques inox
30 Platten-Wärmetauscher inox
Intercambiador 30 placas inox



Valvola autom. sfogo aria scarico laterale
Automatic lateral vent valve
Vanne autom. ouverture air décharge latéral
Automatisches seitliches Entlüftungsventil
Valvula automatica de descarga aire lateral



Valvola sicurezza 1,5 bar c/membrana EPM
Membrane Safety Valve, 1,5 bar
Vanne de sécurité 1,5 bar avec membrane EPM
Membran-Sicherheitsventil 1,5 bar
Valvula de seguridad 1,5 bar con membrana EPM

Valvola sicurezza 3,0 bar c/membrana EPM
Membrane Safety Valve, 3 bar
Vanne de sécurité 3,0 bar avec membrane EPM
Membran-Sicherheitsventil 3 bar
Valvula de seguridad 3,0 bar con membrana EPM



ACCESSORI IDRAULICI

Pozzetto applicaz. term. controllo 1/2"
Heat sump 1/2"
Plongeur pour application therm. controle 1/2"
Oelwanne 1/2"
Vaina applicaz.term.controllo 1/2"



Valvola miscelatrice anticondensa per circuito di ricircolo 55°C attacco 1"
Anti-condensation mixer valve for 55°C recirculation circuit 1" connection
Vanne mélangeuse anti-condensation pour circuit de recirculation 55°C raccord 1"
Antikondensationsmischventil für Rückführungskreislauf 55°C Anschluss 1"
Válvula mezcladora anticondensación para circuito de recirculación 55°C sujeción 1"



Valvola di sicurezza e scarico termico 3/4" 90°C / 3 bar per impianti a vaso aperto
3/4" 90°C / 3 bar Thermal discharge valve
Vanne de sécurité et décharge thermique 3/4" 90°C / 3 bar pour installations à vase d'expansion ouvert
3/4" 90°C / 3 bar Waermeablassventil
Valvula de descargue termico 3/4" 90°C / 3 bar



Scatola parete regolatore TermoProdotti
Surface box for controller for termpoducts
Boîtier régulateur TermoProduits
Wandabdeckung für Thermoprodukte-Steuerung
Caja pared regulador de Termo chimeneas



Valvola a 3 vie motorizzata da 3/4"
Three-way valve 3/4"
Vanne à 3 voies motorisée 3/4"
Dreiwegventil 3/4"
Valvula 3 vias motorizada con 3/4"



Kit Ventilazione

Kit ventilazione Falò, portata del ventilatore a bocca libera 400 mc/h
Falò ventilation kit, fan flow rate with free outlet 400 mc/h
Kit ventilation Falò, capacité du ventilateur à bouche libre 400 cm3/h
Belüftungsbausatz Falò, Volumenstrom des freiblasenden Ventilators 400 mc/h
Kit de ventilación Falò, caudal del ventilador con salida abierta 400 mc/h



Flussostato
Flow sensor
Flussostat
Durchflussmesser
Fluxostato



Kit ventilazione Stefany / Svezia / Norvegia
Stefany / Svezia / Norvegia ventilation kit
Kit ventilation Stefany / Svezia / Norvegia
Belüftungsbausatz Stefany / Svezia / Norvegia
Kit de ventilación Stefany / Svezia / Norvegia



Valvola automatica di scarico termico D.S.A. per TermoProdotti alimentati da combustibili solidi. Attacco 3/4" femmina
Automatic DSA temperature relief valve, 3/4" female nut connection
Vanne automatique de décharge thermique DSA pour combustibles solides.
Connection 3/4" femme.
Automatisches DSA Ablassventil
Valvula automática de descargue tèrmico DSA.
Enchufe 3/4 hembra



Kit ventilazione Rossella R1 / Luna
Rossella R1 / Luna ventilation kit
Kit ventilation Rossella R1 / Luna
Belüftungsbausatz Rossella R1 / Luna
Kit de ventilación Rossella R1 / Luna



Accessori Cottura

Griglia inox a 2 moduli lavabili in lavastoviglie. Disponibile per: America e Cucinotta
 2 stainless steel grille modules washable in dishwasher. Available for: America and Cucinotta
Grille inox à 2 modules lavables dans lave-vaisselle. Disponible pour : America et Cucinotta
 Zweiteiliger Grillrost, spülmaschinengeeignet. Erhältlich für: America und Cucinotta
Rejilla acero inox. de 2 módulos lavables en lavavajilla. Disponible para: America y Cucinotta

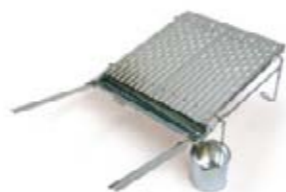

Griglia forno cromata. Disponibile per: Rossella Forno - Nicoletta Forno - Romantica 4,5 - Sovrana - Rosa - Mamy - Italy - TermoRosa - TermoSuprema - Italy Termo - TermoRossella Forno - TermoNicoletta Forno - TermoSovrana.
 Chrome plated oven grille. Available for: Rossella Forno - Nicoletta Forno - Romantica 4,5 - Sovrana - Rosa - Mamy - Italy - TermoRosa - TermoSuprema - Italy Termo - TermoRossella Forno - TermoNicoletta Forno - TermoSovrana.
Grille four chromée. Disponible pour : Rossella Four - Nicoletta Four - Romantica 4,5 - Sovrana - Rosa - Mamy - Italy - TermoRosa - TermoSuprema - Italy Termo - TermoRossella Forno - TermoNicoletta Forno - TermoSovrana.
 Backofenrost verchromt Erhältlich für: Rossella Forno - Nicoletta Forno - Romantica 4,5 - Sovrana - Rosa - Mamy - Italy - TermoRosa - TermoSuprema - Italy Termo - TermoRossella Forno - TermoNicoletta Forno - TermoSovrana.
Rejilla de horno cromada. Disponible para: Rossella Forno - Nicoletta Forno - Romantica 4,5 - Sovrana - Rosa - Mamy - Italy - TermoRosa - TermoSuprema - Italy Termo - TermoRossella Forno - TermoNicoletta Forno - TermoSovrana.



Griglia forno cromata. Disponibile per: Rosetta
 Chrome plated oven grille. Available for: Rosetta
Grille four chromée. Disponible pour : Rosetta
 Backofenrost verchromt. Erhältlich für: Rosetta
Rejilla de horno cromada. Disponible para: Rosetta



Accessori Cucine e TermoCucine

Kit vasca inox 3,5. Disponibile per: Romantica 3,5 - Rosetta
 3.5 stainless steel tank kit. Available for: Romantica 3,5 - Rosetta
Kit cuve inox 3,5. Disponible pour : Romantica 3,5 - Rosetta
 Bausatz Wasserschiff Edelstahl 3,5. Erhältlich für: Romantica 3,5 - Rosetta
Kit cuba acero inox. 3,5. Disponible para: Romantica 3,5 - Rosetta

Kit vasca inox 4,5. Disponibile per:
 Romantica 4,5 - Rosa - Rosa Reverse - Sovrana - Sovrana Easy - TermoRosa - TermoRosa Ready - TermoSovrana
 4.5 stainless steel tank kit. Available for:
 Romantica 4,5 - Rosa - Rosa Reverse - Sovrana - Sovrana Easy - TermoRosa - TermoRosa Ready - TermoSovrana
Kit cuve inox 4,5. Disponible pour:
 Romantica 4,5 - Rosa - Rosa Reverse - Sovrana - Sovrana Easy - TermoRosa - TermoRosa Ready - TermoSovrana
 Bausatz Wasserschiff Edelstahl 4,5. Erhältlich für:
 Romantica 4,5 - Rosa - Rosa Reverse - Sovrana - Sovrana Easy - TermoRosa - TermoRosa Ready - TermoSovrana
Kit cuba acero inox. 4,5. Disponible para:
 Romantica 4,5 - Rosa - Rosa Reverse - Sovrana - Sovrana Easy - TermoRosa - TermoRosa Ready - TermoSovrana



Kit griglia mobile Rosa
 Rosa mobile grille kit
Kit grille mobile Rosa
 Kit beweglicher Rost Rosa
Kit rejilla móvil Rosa

Kit griglia mobile Rosetta
 Rosetta mobile grille kit
Kit grille mobile Rosetta
 Kit beweglicher Rost Rosetta
Kit rejilla móvil Rosetta



Kit centrino levigato completo di due coperchi in ghisa smaltata vetrificata antracite. Disponibile per: Suprema - TermoSuprema
 Plates with enameled Polished plate with 2 black enameled vitrified iron coversast iron top plates for Suprema - TermoSuprema
Kit plaque de cuisson en fonte polie avec 2 couvercles en fonte émaillée vitrifiée noir
 Satz geschliffene Herdplatte mit 2 schwarzen emaillierten glasierten Gussdeckeln
Kit plata con arandelas con 2 tapas en fundición esmaltada vitrificado negra



Kit Coperchio Sovrana Easy
 Sovrana Easy cover kit
Kit couvercle Sovrana Easy
 Bausatz Abdeckplatte Sovrana Easy
Kit tapa Sovrana Easy



Fianchi per installazione uscita fumi laterale. Disponibile per: Vicenza - Verona - Padova
 Flanks for side smoke outlet installation. Available for: Vicenza - Verona - Padova
Côtés pour l'installation de sortie des fumées latérale. Disponible pour: Vicenza - Verona - Padova
 Seitenteile für die Installation des seitlichen Rauchgasaustritts. Erhältlich für: Vicenza - Verona - Padova
Laterales para la instalación de salida de humos lateral. Disponible para: Vicenza - Verona - Padova



Top con altezza 4 cm. Disponibile per: Vicenza - Verona - Padova
 Top with 4 cm height. Available for: Vicenza - Verona - Padova
Top de 4 cm de haut. Disponible pour: Vicenza - Verona - Padova
 Oberteil mit Höhe 4 cm. Erhältlich für: Vicenza - Verona - Padova
Revestimiento con altura de 4 cm. Disponible para: Vicenza - Verona - Padova



Accessori

Spugnetta Dry Wiper / Dry Wiper sponge / Éponge Dry Wiper / Dry Wiper Schwamm / Esponja dry wiper

Speciale per la pulizia a secco del vetro ceramico di stufe e camini. Confezione completa di 14 spugnette Dry Wiper
 Specific for cleaning the ceramic glass of stoves and fireplaces without water. Pack containing 14 Dry Wiper sponges
 Spéciale pour le nettoyage à sec de la vitre céramique des poêles et des cheminées. Boîte complète de 14 éponges Dry Wiper
 Speziell für die Trockenreinigung von Glaskeramikfenstern an Öfen und Kaminen. Packung, komplett mit 14 Dry Wiper Schwämmen
 Especial para la limpieza en seco del cristal cerámico de estufas y chimeneas. caja con 14 esponjas dry wiper



WindFire

Accenditore a gas e soffiatore d'aria elettrico alimentato a batterie.
 Gas igniter and battery-powered electric air blower.
 Allumeur à gaz et soufflerie d'air électrique alimentée par batterie.
 Gasanzünder und elektrisches, mit Batterien gespeistes Luftgebläse.
 Encendedor de gas y soplador de aire eléctrico con baterías.



Spazzacamino, accessorio per la pulizia di stufe, camini e barbecue
 Chimney Sweep, accessory for cleaning stoves, fireplaces and barbecues
 Ramoneur, accessoire pour le nettoyage des poêles, des cheminées et des barbecues
 Kaminbesen, Zubehörteil für die Reinigung von Öfen, Kaminen und Barbecues
 Deshollinador, accesorio para la limpieza de estufas, chimeneas y barbacoas



Espositore completo di 12 Spazzacamino
 Palbox with 12 pieces Ash-cleaner
 Palbox avec 12 unités Spazzacamino
 Aussteller mit 12 Spazzacamino
 Expositor completo de 12 deshollinadores

Bomboletta spray antracite 600° C senotherm 400 ml
 Anthracite 600° senotherm ml 400 spray can
 Bombe de peinture spray anthracite 600° Senotherm 400ml
 Spraydose Anthrazit 600° Senotherm 400 ml
 Spray negro 600° Senotherm 400ml



Rosone copriforno per Falò / Ceramic covering for Falò oven / Rond couvre-feu pour Falò
 Majolikaabdeckung des Backfaches für Falò / Rosetón cubre horno para Falò



Bordeaux / Burgundy / Bordeaux / Bordeaux / Burdeos
 Sabbia / Sand / Sable / Sand / Arena
 Turchese / Turquoise / Turquoise / Türkis / Turquesa
 Giallo / Yellow / June / Gelb / Amarillo

Pedana in acciaio verniciato / Painted steel platform / Plaque de sol en acier peinte
 Bodenplatte aus lackiertem Stahl / Plataforma de acero barnizado
 1000x900x2.5 mm
 900x800x2.5 mm
 700x600x2.5 mm



Pedana Crystal Nera/ Crystal black platform / Plaque de sol crystal noir /
 Schutzplatte Crystal Schwarz / Plancha-pedana Crystal
 990x900x8 mm
 900x800x8 mm
 700x600x8 mm



Pedana Crystal Nera/ Crystal black platform / Plaque de sol crystal noir /
 Schutzplatte Crystal Schwarz / Plancha-pedana Crystal



ø 900x8 mm
 ø 1100x8 mm

Accessori Fumisteria

Raccordo anticondensa / Anti-condensation fitting / Raccord anti-condensation /
 Antikondensationsanschlussstück / Racor anticondensación

2 mm Ø 120 mm
 2 mm Ø 130 mm
 2 mm Ø 150 mm
 2 mm Ø 160 mm
 2 mm Ø 200 mm
 2 mm Ø 250 mm



Tubo / Pipe / Tuyau / Rohr / Tubo

Ø 160 mm - lunghezza: 1000 mm - spessore: 1,2 mm
 Ø 160 mm - lunghezza: 500 mm - spessore: 1,2 mm
 Ø 160 mm - lunghezza: 250 mm - spessore: 1,2 mm



Tubo telescopico Ø 160 mm spessore 1,2 mm
 Telescopic pipe Ø 160 mm 1.2 mm thick
 Tuyau télescopique Ø 160 mm épaisseur 1,2 mm
 Teleskoprohr Ø 160 mm Stärke 1,2 mm
 Tubo telescópico Ø 160 mm espesor 1,2 mm



Curva 90° Ø 160 mm spessore 1,2 mm
 Curve 90° Ø 160 mm Thickness 1,2 mm
 Coude 90° Ø 160 mm épaisseur 1,2
 Rohrbogen 90° Ø 160 mm Stärke 1,2
 Curva 90° Ø 160 mm espesor 1,2



Rosone Ø 160 mm
 Rosette Ø 160 mm
 Rond Ø 160 mm
 Rosette Ø 160 mm
 Rosetón Ø 160 mm



Anello Ø 160 mm
 Ring Ø 160 mm
 Anneau Ø 160 mm
 Ring Ø 160 mm
 Aro Ø 160 mm





Dimensioni (mm)
Dimensions (mm)
Dimensions (mm)
Masse (mm)
Dimensiones (mm)



Diametro tubo scarico fumi (mm)
Smoke outlet diameter (mm)
Diamètre sortie de fumées (mm)
Rauchrohrdurchmesser (mm)
Dimensiones salida humos (mm)



Diametro tubo aspirazione aria (mm)
Air intake pipe diameter (mm)
Diamètre tuyau d'aspiration d'air (mm)
Rohrdurchmesser Rauchansaugrohr (mm)
Diámetro tubo de aspiración del aire (mm)



air-1 Aria primaria regolabile
Adjustable primary air
Air primaire réglable
Verstellbare Primärluft
Aire primario regulable



air-2 Aria secondaria regolabile
Adjustable secondary air
Air secondaire réglable
Verstellbare Sekundärluft
Aire secundario regulable



air-3 Aria terziaria prearata
Pre-adjusted tertiary air
Air tertiare pre-tarée
Voraustaritierte Tertiärluft
Aire terciario precalibrado



Peso netto (kg)
Net weight (kg)
Poids net (kg)
Netto Gewicht (kg)
Peso Neto (kg)



Focolare
Hearth
Foyer
Feuerraum
Hogar



Dimensioni focolare (mm)
Hearth size (mm)
Dimensions foyer (mm)
Größe des Feuerraum (mm)
Dimensiones hogar (mm)



Acciaio
Steel
Acier
Stahl
Acero



Ghisa
Cast-iron
Fonte
Gusseisen
Hierro fundido



Refrattari
Refractory
Refractaire
Feuerbeständig/Schamotte
Refractario



Dimensioni bocca fuoco (mm)
Hearth opening size (mm)
Dimensions porte du foyer (mm)
Größe der Feuerraumsöffnung (mm)
Dimensiones boca del hogar (mm)



Dimensioni forno (mm)
Oven size (mm)
Dimensions four (mm)
Abmessungen des Backofens (mm)
Dimensiones horno (mm)



Facciata
Facing
Facade
Abmessung
Fassade
Parte frontal



Presa d'aria esterna (cm²)
Outer air inlet (cm²)
Prise d'air externe (cm²)
Außenlufteintritt (cm²)
Toma de aire exterior (cm²)



Dimensione canna fumaria (mm)
Dimensions chimney flue (mm)
Dimensions conduit de funeées (mm)
Abmessungen Schornstein (mm)
Dimensiones conducto de humo (mm)



Altezza canna fumaria (m)
Height chimney flue (m)
Hauteur conduit de funeées (m)
Höhe Schornstein (m)
Altura conducto de humo (m)



Potenza termica nominale utile (kW)
Nominal thermal power (kW)
Puissance nominale utile (kW)
Nennwärmeleistung (kW)
Potencia nominal útil (kW)



Potenza termica globale (kW)
Global thermal power (kW)
Puissance thermique globale (kW)
Gesamte Wärmeleistung (kW)
Potencia térmica total (kW)



Potenza resa al liquido (kW)
Power given back to water (kW)
Puissance rendue a l'eau (kW)
Wärmerückleistung (kW)
Potencia suministrada al líquido (kW)



Telecomando
Remote Control
Télécommande
Fernbedienung
Mando a distancia



Ventilazione forzata
Convection fan
Ventilation air chaud
Sekundärluft
Ventilación forzada



Colori
Colours
Couleurs
Farben
Colores



Potenza resa all'ambiente (kW)
Power given back to the room (kW)
Puissance rendue à l'air (kW)
Wärmeleistung (kW)
Potencia suministrada al local (kW)



Consumo orario (kg/h)
Hourly consumption (kg/h)
Consommation (kg/h)
Stundenverbrauch (kg/h)
Gasto horario (kg/h)



Capacità totale serbatoio (kg)
Feed box Total capacity (kg)
Capacité totale réservoir (kg)
Tank-Gesamtkapazität (kg)
Capacidad total depósito (kg)



Di Serie
Equipped with
De série
Ausgestattet mit
Equipo base



Fino ad esaurimento scorte
while stocks last
Jusqu'à épuisement des stocks
Solange der Vorrat reicht.
Hasta agotamiento stocks



In fase di omologazione
Approval in progress
Certification en cours
Prüfung im Lauf
En proceso de homologación



Diametro tubo scarico automatico
Automatic discharge pipe diameter
Diamètre tuyau évacuation automatique
Rohrdurchmesser automatischer Auslass
Diámetro del tubo de desagüe automático



Assorbimento elettrico (W)
Electric consumption (W)
Absorption électrique (W)
Stromaufnahme (W)
Consumo eléctrico (W)



Temperatura ottimale d'esercizio (°C)
Optimal working temperature (°C)
Température optimale de fonctionnement (°C)
Optimale Betriebstemperatur (°C)
Temperatura optima de trabajo (°C)



Pressione d'esercizio (bar)
Working pressure (bar)
Puissance d'exercice (bar)
Arbeitsdruck (bar)
Presión de trabajo (bar)



Allacciamento caldaia ø
Boiler connection ø
Connection chaudière ø
Kesselanschluss ø
Conexión de la caldera ø



Contenuto fluido scambiatore (l)
Fluid contents of the exchanger (l)
Liquide contenu dans l'échangeur (l)
Gehalt Flüssigkeit im Ausstauscher (l)
Contenido fluido intercambiador (l)



Rendimento (%)
Efficiency (%)
Rendement (%)
Wirkungsgrad (%)
Rendimiento (%)



Tiraggio (Pa)
Draught (Pa)
Tirage (Pa)
Abzug (Pa)
Tiro (Pa)



m³ riscaldabili (30 kcal/h x m3)
Heatable m3 (30 kcal/h x m3)
m3 que l'on peut chauffer (30 kcal/h x m3)
Heizungsvermögen m3 (30 kcal/h x m3)
m3 con posibilidad de calefacción (30 kcal/h x m3)

Colori / Colours / Couleurs / Farben / Colores

AL: Albicocca / Apricot / Abricot / Aprikose / Albaricoque

AM: Ametista / Amethyst / Améthyste / Amethyst / Amatista

BI: Bianco / White / Blanc / Weiss / Blanco

BIN: Bianco Infinity / White Infinity / Blanc Infinity / Weiss Infinity / Blanco Infinity

BO: Bordeaux / Burgundy / Bordeaux / Bordeaux / Burdeos

BW: Marrone / Brown / Marron / Braun / Marrón

CMO: Crema Opaco / Matt cream / Creme opaque / Matt Cream / Crema opaco

CP: Cappuccino

CRY: Crystal

CU: Cuio / Leather / Cuir / Leder / Cuero

GI: Giallo / Yellow / June / Gelb / Amarillo

IN: Inox / Inox / Inoxidable / Edelstahl / Inoxidable

MA: Magnolia

MF: Marrone sfumato / Soft brown / Marron nuancé / Verschw. Braun / Marrón esfumado

MD: Madreperla / Mother of pearl / Nacre / Perlmutter / Nacar

NE: Nero antracite / Anthracite black / Noir antracite / Schwarz-Anthrazit / Negro antracita

NEL: Nero Lucido / Bright black / Noir brillant / Glänzendes Schwarz / Negro brillante

OC: Oro Craquelé / Gold craquelé / Or craquelé / Gold craquelé / Oro craquelé

PE: Pergamena / Parchment / Parchemin / Pergament / Pergamino

PT: Pietra Naturale / Natural stone / Pierre naturelle / Naturstein / Piedra natural

RU: Rustic

SAM: Silk Vogue Ametista

SB: Sabbia / Sand / Sable / Sand / Arena

SI: Silver

SL: Salmone / Salmon pink / Saumon / Lachsrot / Salmón

TI: Titanio / Titanium / Titane / Titan / Titanio

TU: Turchese / Turquoise / Turquoise / Türkis / Turquesa

VE: Verde / Green / Vert / Grün / Verde

Altre linee di prodotto disponibili a catalogo

Other product lines, available as per catalogue.
Autres lignes de produit, disponibles selon catalogue.
Andere Produktlinien, verfügbar gemäss Katalog.
Otras líneas de producto disponibles en el catálogo.



Collezione TermoProdotti Thermo-products Collection Collection des Thermoproduits Thermoprodukte Kollektion Colección Termoproductos

N.B.: I prodotti La Nordica devono essere collegati a canne fumarie con un tiraggio compreso tra 10 Pa e 17 Pa, come riportato nel libretto d'istruzioni in dotazione ad ogni prodotto. I termoprodotto devono essere collegati a canne fumarie con tiraggio compreso tra 17 Pa e 20 Pa.
Note: La Nordica products must be connected to chimneys having a draught between 10 Pa and 17 Pa as indicated by the instruction manual which is supplied along with any product. The Thermoproducts must be connected to chimneys with a draught between 17 Pa and 20 Pa.
Attention: Les produits La Nordica doivent se raccorder à conduits de fumées avec un tirage entre 10-17 Pa, comme indiqué sur les manuels d'instruction que Vous trouvez sur chaque appareil. Les Thermoproduits doivent se raccorder à conduits de fumées avec un tirage entre 17-20 Pa.
Achtung: Der Unterdruck im Schornstein soll für La Nordica Produkte zwischen 10-17 Pascal betragen, wie in unserer Bedienungsanleitung gezeigt ist. Der Unterdruck im Schornstein für die Thermoprodukte soll zwischen 17-20 Pascal betragen.
Nota: los productos La Nordica tienen que ser conectados a los conductos de humos con un tiro entre 10 Pa y 17 Pa como está indicado por el manual de instrucción en el equipamiento base de cada producto. Los termoproductos tienen que ser conectados a los conductos de humo con un tiro entre 17 Pa y 20 Pa.

La riproduzione dei colori è indicativa, in quanto stampati. - Due to printing reasons the reproduction of colours has to be considered only indicative. - La reproduction des couleurs est indicative, car imprimées. - Die gezeichneten Farben sind wegen Druckgründe nur ein Beispiel. - La reproducción de los colores es indicativa en cuanto impresos.

Le maioliche "La Nordica-Extrafame" sono prodotti di alta fattura artigianale e come tali possono presentare micropuntature e piccole imperfezioni sulla superficie. Queste stesse piccole caratteristiche ne testimoniano la pregiata natura. - "La Nordica-Extrafame" majolicas are handmade high-quality products and therefore they present crackles, speckles and shadings. These characteristics certify their precious origin. - Les faïences "La Nordica-Extrafame" sont des produits de haute facture artisanale et comme tels elles peuvent présenter des micro-piqûres et des petites imperfections sur la surface. Ces petites caractéristiques en témoignent leur grande valeur. - Die Majolika-Fliesen „La Nordica-Extrafame“ sind hochwertige handwerkliche Produkte und können als Zeichen dessen kleine Punkte und Unregelmäßigkeiten auf der Oberfläche aufweisen. Diese Eigenschaften zeugen von ihrer wertvollen Herkunft. - Las mayolicas "La Nordica-Extrafame" son unos productos de alta elaboración artesanal y, como tales, pueden presentar pequeños puntos e imperfecciones en la superficie. Estas minúsculas características dan fe de su valor.

I prodotti La Nordica ed Extrafame possono essere coperti da privative industriali (come ad es. brevetti, design e marchi) di proprietà esclusiva La Nordica ed Extrafame. È fatto divieto violare tali diritti come pure divieto rimuovere, sopprimere o alterare i marchi apposti ai prodotti e di apporre altri. - The La Nordica-Extrafame products can be covered by industrial property rights (such as patents, designs and trademarks) owned by La Nordica-Extrafame exclusively. It is strictly forbidden to violate these rights as for removing, cancelling or corrupting the trademarks impressed on the products and impressing others. - Les produits "La Nordica ed Extrafame" peuvent être protégés par un monopole industriel (ex.: brevets, designs et marques) appartenant exclusivement à La Nordica-Extrafame. Il est strictement interdit de violer ces droits tout comme il est interdit d'enlever, de supprimer ou altérer les marques des produits et d'en ajouter d'autres. - Die Produkte „La Nordica ed Extrafame“ können mit industriellen Schutzrechten (wie z.B. Patente, Designs und Markennamen) belegt sein, die ausschließliches Eigentum von La Nordica-Extrafame sind. Die Verletzung dieser Rechte sowie die Entfernung, Behinderung oder Veränderung der auf den Produkten angebrachten Markenzeichen und das Anbringen von anderen Markenzeichen ist untersagt. - Los productos "La Nordica-Extrafame" pueden estar protegidos por derechos industriales (como patentes, diseño y marcas) de propiedad exclusiva La Nordica-Extrafame. Se prohíbe violar dichos derechos, al igual que quitar, suprimir o alterar las marcas que figuran sobre el producto y poner otras.

Prima dell'acquisto, richiedere al Vostro rivenditore tutte le informazioni relative all'apparecchio. Inoltre è necessario tenere in considerazione anche tutte le leggi e le normative nazionali, regionali, provinciali e comunali presenti nel paese in cui sarà installato l'apparecchio, nonché delle istruzioni contenute nel manuale d'uso. - Before the purchase, ask to your reseller all the information regarding the appliance. One must also bear in mind all laws and national, regional, provincial and town council Standards present in the country in which the appliance has been installed, as well as the instructions contained in this manual. - Avant l'achat, demandez à Votre revendeur toutes les informations qui regardent l'appareil. Il faut respecter toutes les lois et réglementations nationales, régionales, provinciales et communales existant dans le pays où a été installé l'appareil, ainsi que les instructions contenues dans le présent manuel. - Bevor dem Einkauf, fordern Sie Ihrem Verkäufer alle Informationen hinsichtlich des Gerätes wieder. Beachtet werden müssen auch sämtliche Gesetze und Vorschriften, die auf Landes-, Regional-, Provinz- und Gemeindeebene in dem Land gelten, in dem das Gerät installiert wird, sowie die in diesem Handbuch enthaltenen Anweisungen. - Antes de la compra, solicitar al vuestro revendedor todas las informaciones respecto de l'aparato. Es necesario considerar también todas las leyes y las normativas nacionales, regionales, provinciales y municipales presentes en el país en el que se instala el equipo, además de las instrucciones contenidas en el presente manual.

Le immagini contenute nel presente documento sono da considerare solo rappresentative della parte estetica del prodotto, non costituiscono quindi indicazioni per le prestazioni o le caratteristiche tecniche dello stesso. - The images contained in this document are for product illustration purposes only and do not represent indications for the performance or technical characteristics of the same. - Les images contenues dans le présent document doivent être considérées comme purement représentatives de l'aspect esthétique du produit et ne constituent donc pas des indications relatives aux performances ou aux caractéristiques techniques de ce dernier. - Die Abbildungen im vorliegenden Handbuch sind nur als exemplarische Ansichten gedacht, sie geben daher keine Angaben zu den Leistungen oder technischen Eigenschaften des Produktes. - Las imágenes incluidas en el presente documento son meramente indicativas de la parte estética del producto y, por lo tanto, no dan indicaciones del rendimiento ni de las características técnicas del mismo.

Tutti i dati sono rilevati usando pellet omologato secondo normativa Ö M 7135. - All the figures were measured using approved pellets in compliance with Ö M 7135. - Toutes les données sont relevées en utilisant des pellets homologués conformément aux normes Ö M 7135. - Alle Angaben sind unter Einsatz von laut Ö M 7135 homologierten Pellet festgestellt worden. - Todos los datos han sido relevados utilizando gránulos homologados según las normativas Ö M 7135.

Le ambientazioni visibili nelle foto, sono state realizzate con l'impiego di pavimentazioni in materiale ignifugo. La ditta si riserva di apportare le modifiche che riterrà più opportune senza darne preavviso, per esigenze tecniche o commerciali, e non si assume responsabilità per eventuali errori e inesattezze sul contenuto del catalogo. I dati e le misure forniti hanno valore puramente indicativo. Tutte le immagini e loro diritti appartengono in via esclusiva a La Nordica S.p.A. Tutti i diritti sono riservati. - The interiors illustrated in the photographs were created using fireproof flooring. The company reserves the right to introduce the technical or commercial changes it holds to be opportune without giving prior notice. The company shall not be responsible for any errors or mistakes in the contents of the catalogue. Data and dimensions that are provided are for an indication only. All images and their rights are the exclusive property of La Nordica S.p.A. All rights reserved. - les décors visibles sur les photos ont été réalisés avec des revêtements de sol en matériel ignifuge. La firme se réserve le droit d'apporter les modifications qu'elle estimera opportunes, sans préavis, pour des exigences techniques ou commerciales. Elle dégage toute responsabilité pour des erreurs et des inexactitudes éventuelles contenues dans le catalogue. Les données et les dimensions fournies sont purement indicatives. Toutes les images et leurs droits appartiennent exclusivement à La Nordica S.p.A. Tous droits réservés. - Die aus den Fotos ersichtlichen Ambiente wurden mit Bodenbelägen aus feuerfestem Material realisiert. Die Firma behält sich vor, nach eigenem Ermessen ohne Ankündigung Änderungen technischer oder geschäftlicher Art anzubringen. Für eventuelle Fehler oder Ungenauigkeiten, was den Kataloginhalt angeht, wird keine Haftung übernommen. Daten und Maßangaben sind nicht verbindlich. Alle Abbildungen und betreffenden Rechte gehören ausschließlich der La Nordica A.p.A. Alle Rechte vorbehalten. - Las decoraciones visibles en las fotografías han sido realizadas por la colocación de unas pavimentaciones en material ignifugo. La empresa se reserva el derecho de introducir las modificaciones que reputa más oportunas, sin previo aviso, para exigencias técnicas o comerciales, y rehúsa cualquier responsabilidad por los eventuales errores y equivocaciones contenidos en el catálogo. Los datos y medidas que se suministran tienen valor únicamente aproximado. Todas las imágenes y los derechos pertenecen en exclusiva a La Nordica S.p.A. Todos derechos reservados.

I materiali lapidei naturali, come la pietra ed il marmo, per propria essenza sono soggetti a variazioni estetiche di tono, colore e venatura sia tra un pezzo e l'altro che rispetto ad un campione visto. Eventuali differenze sono quindi da considerare caratteristiche peculiari ed elementi distintivi del materiale stesso che ne certificano l'unicità, valore assoluto di questo tipo di prodotto. - Due to its nature, natural stone material, such as marble, is subject to aesthetic variations in shade, colour and grain pattern when comparing one piece to another and also to a sample. Therefore, any differences are to be considered particular characteristics and distinctive elements of the material itself that certify the uniqueness, which is the absolute value of this type of product. - Les matériaux pierreux naturels tels que la pierre et le marbre sont sujets de par leur nature à des variations esthétiques de ton, de couleur et de veinage, aussi bien d'une pièce à l'autre que par rapport à un échantillon de référence. Les éventuelles différences doivent donc être considérées comme des caractéristiques particulières et des éléments distinctifs du matériau qui attestent son unicité, valeur absolue de ce type de produit. - Naturmaterialien wie Stein und Marmor können aufgrund ihres Wesens in ihrer Beschaffenheit, dem Farbton und der Maserung unterschiedlich sein und von dem gesehenen Muster abweichen. Mögliche Unterschiede sind daher als besondere Eigenschaften und Unterscheidungselemente des Materials selbst anzusehen, die seine Einzigartigkeit bescheinigen und den absolute Wert dieser Produktart ausmachen. - Los materiales lápidos naturales, como la piedra y el mármol, por su esencia pueden sufrir cambios estéticos de tono, color y vetado, ya sea entre dos piezas que respecto a una muestra vista. Las diferencias se deben por lo tanto considerar como características peculiares y elementos de distinción del mismo material, que certifican la excepcionalidad, valor absoluto de este tipo de producto.



Collezione prodotti a pellet Pellet Products Collection Collection d'Appareils à granulés (Pellets) Kollektion Pelletprodukte Colección productos de pellet



Collezione Caminetti Fireplaces Collection Collection des Cheminées Kamin Kollektion Colección Chimeneas

PURO CALORE
MADE IN ITALY

MGA GROUP

Stufa a legna ventilata modello Fib colore bianco

NORDICA
Extraflame
Riscalda la vita.

www.lanordica-extraflame.com



La Nordica S.p.A.
Sede: Via Summano, 104
36030 Montecchio Precalcino - Vicenza - Italy
Tel. +39 0445 804000
Fax +39 0445 804040
info@lanordica.com

Extraflame S.p.A.
Via dell'Artigianato, 12
36030 Montecchio Precalcino - Vicenza - Italy
Tel. +39 0445 865911
Fax +39 0445 865912
info@extraflame.it

www.lanordica-extraflame.com