

marco



POURING PERFECTION

Marco Beverage Systems Ltd.

INSTRUCTIONS FOR MODEL

Ecoboiler UC45

1000743 (2.8kW)
1000744 (5.6kW)
1000744US (5.6kW)
1000745 (8.4kW)
1000753 (2.8kW)
1000754 (5.6kW)
1000755 (8.4kW)
1000743A (2.8kW)
1000744A (5.6kW)
1000745A (8.4kW)
1000753A (2.8kW)
1000754A (5.6kW)
1000755A (8.4kW)



Water pressure : 5 - 50 psi (min.-max.)35 - 345 kPa (min.-max.)

Marco Beverage Systems Limited. 63d Heather Road, Sandyford Industrial Estate, Dublin 18.	Marco Beverage Systems Limited. Shire House, Strixton Manor, Strixton, Wellingborough, Northants, NN29 7PA
Ireland Tel: +353 (0)1 295 2674 Ireland Fax: +353 (0)1 295 3715 email: sales@marco.ie www.marco.ie	UK Tel: +44 (0)2072 744 577 UK Fax: +44 (0)2079 788 141 email: sales@marco-bev.co.uk www.marco-bev.co.uk

Installation details:

Power Supply:

- 1000744, 100744US, 1000744A, 1000754, 1000754A (5.6kW/230V, 6.1kW/240V) - This needs to be connected to a 30A isolator outlet.
- 1000743, 1000743A, 1000753, 1000753A(2.8kW, 230V) – connected via a 13A plug.
- 1000745, 1000745A, 1000755 , 1000755A (8.4kW, 230V) – requires a 3 Phase (3L,-N-PE) Connection.
A qualified electrician should carry out such connections.
- 1000746 - The unit must be connected to a suitable three-phase power supply. A qualified electrician must do this.
 - See Rating Plate for supply voltage and power rating.

Water Pressure: 5 - 50 psi (min.-max.) 35 - 345 kPa (min.-max.)

Installation procedure:

- Mains water pressure required (limits): 5-50psi (35-345kPa)
- Fit a stop Valve on a cold water line and attach a 3/4" BSP male fitting,
- (e.g. 3/4" x 1/2" 311 or washing machine type stop valve).
- For US versions use 3/8" NPT male fitting.
- Connect straight tailpiece of the hose to the stop valve fitting. Make sure that the pre-attached sealing washer is fitted.
- Turn on the water to flush any impurities, dust etc. from the inlet hose and water pipe. Allow several gallons through.
- Connect right-angled tailpiece of the hose to the inlet valve of the boiler (again 3/4" BSP). Make sure the sealing washer is fitted here also.
- Turn on water and check for leaks.
- If the overflow vent is plumbed it must be plumbed with a tundish device.
- This equipment must be installed with adequate backflow protection to comply with all applicable federal, state and local codes.

NOTE: In time-dispense application, supplied non-return valve may be fitted into the front silicone connect to the water front connection. Ensure the black line on the non-return is in the correct orientation. (Black line to the bottom)



ECO BOILER VERSION

1000743 (2.8kW), 1000744 (5.6kW), 1000744US (5.6kW), 1000745 (8.4kW), 1000743A (2.8kW),
1000744A (5.6kW), 1000745A (8.4kW)

Operating boiler for the first time:

Setting time dispense for two left hand side pumps.

- Open the service door on the front panel
- Once the machine is full and heated up (the status LED glowing green) press the tactile switch on the TOP control PCB (timer board).
- Both pumps will turn on and off for 0.1s - that will be heard as a click meaning that the timer is in the calibration mode. For 3 pump version see note 8 below.
- Place an empty cup (measuring jug) underneath the font that is to be calibrated.
- Press and hold a font button until you get the right amount of water. The water do not have to be dispensed in a single push - if the button is pressed few times the overall time will be used.
- Do the same action with the other font if needed. If only one font is calibrated, settings for the other will not be altered.
- The minimum time possible for the time dispense operation is 1s. Setting the dispense time for less (quick font button click) will set the font back into "push & hold" mode.
- After the volumes are set properly press the tactile button on the timer board once again.
- Both pumps will turn on and off for 0.1s twice - that will be heard as a double click meaning that the timer is out of calibration.
- Please note that there is no given order which font is to be calibrated first - in fact they may be calibrated at once or only one may be calibrated (leaving the settings of the other unaltered).
- If there is no response from the user in the calibration mode (none of the font buttons pressed) for more than 25 seconds the timer will end the calibration (double pump "click" will be heard).
- The maximum allowable time of dispense is 25 seconds. Any longer times will be cut down to 25 seconds.
- The resolution of the time measurement is 0.1s.
- The timer board has its own clock on board therefore power line frequency is not used to measure the time.

Setting time dispense for right hand side pump (3 font version only)

- Open the service panel.
- Make sure that the machine is powered, filled and heated (ready lamp green).
- Press calibration tactile button on the BOTTOM control PCB for a second until status lamp starts blinking red-green.
- Set new dispense time by pressing dispense button to obtain the required output volume of water. Button may be pressed several times – all times / volumes will be added together.
- To confirm and save new value press calibration button on the PCB for a second until the status lamp stops blinking.
- Setting dispense time / volume to zero (omit step 4) will make the machine work as "push & hold" (water dispensed as long as the button is pressed).

Troubleshooting:

The Ready/Status light signals various errors or problems.

A cycle of red flashes indicates an error. The number of flashes in a cycle corresponds to the symptom in the table below:

Status/Diagnostic light guide:

LED	Status
AMBER	Tank below set point temperature. Machine is heating.
GREEN	Machine ready.
FLASHING RED	Diagnostics error. See table below. NOTE: It is normal for the machine to show two flashes error (<i>water level below elements</i>) once it is filling for the first time.

Note: Some of the error sequences will be displayed if there is low water pressure. Please check that there is water pressure and that the water stop-valve is open before calling your service agent.

No of flashes	Symptom	Action required
2	Water level below elements. Normal when machine first fills.	Check water pressure , if this is OK then call service agent.
3	Temperature sensor failure (s/c)	Call service agent
4	Water not heating	Call service agent
5	Temperature sensor failure (o/c)	Call service agent
6	Machine not filling	Check water pressure.

ECO SMART VERSION

1000753 (2.8kW), 1000754 (5.6kW), 1000755 (8.4kW), 1000753A (2.8kW), 1000754A (5.6kW),
1000755A (8.4kW)

Operating boiler for the first time:

- Check that all installation procedures have been carried out.
- Ensure water valve is on.
- Plug boiler into 13A socket and press power button on the front of the machine marked 'Power'. Refer to Figure 1.
- The “power on” light will glow green and the machine will fill to a safe level, above the elements, before heating. The display will show the current water temperature and the status “ Filling...”
- The “Ready/Status” light will cycle two red flashes while the machine is filling to the safe level.
- After this amount of water has heated to about 92°C the boiler will draw more water in until the temperature drops by 1 or 2 degrees. The boiler will then heat again. This heat fill cycle continues until the boiler is full.
- While filling, the “Ready/Status” light will remain blank.
- The “Ready/Status” light will glow green when the machine is both full and up to normal operating temperature. For 10L machines allow approx 30 minutes.
- The boiler is now ready for use – the display will show the Water Temperature and the status “ READY”.
- The Boiler may now be used to dispense Hot Water to the preset factory settings.
 - 90°C
 - Push and Hold operation
 - Continuous flow – no pulsing
 - Auto heat Fill Mode.

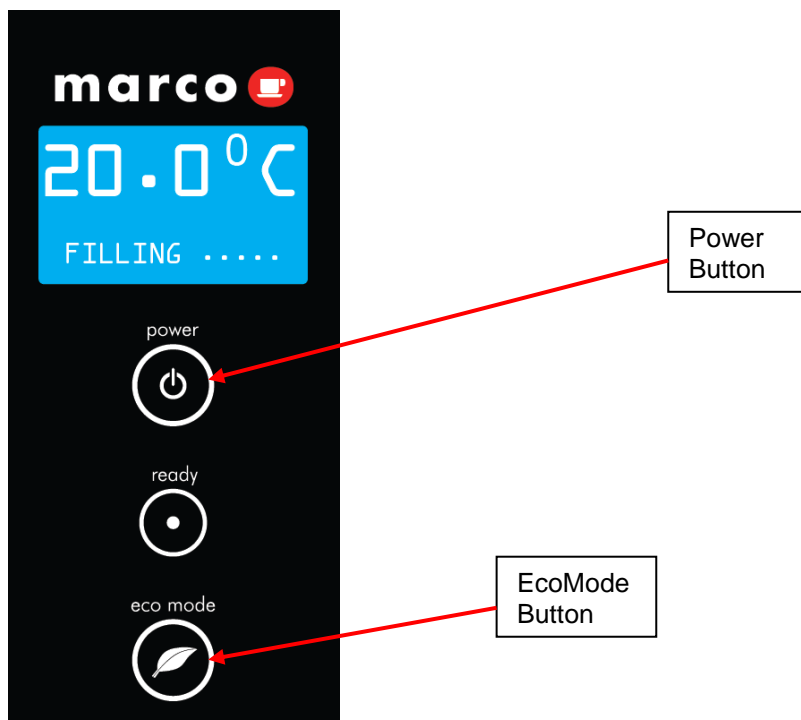

Figure 1: Machine User Interface

NOTE: Because the boiler is electronically controlled no priming is necessary.
The element cannot switch on until a safe level of water is reached.

Setting time dispense for two left hand side pumps.

- Open the service door on the front panel
- Once the machine is full and heated up (the status LED glowing green) press the tactile switch on the TOP control PCB (timer board).
- Both pumps will turn on and off for 0.1s - that will be heard as a click meaning that the timer is in the calibration mode. For 3 pump version see note 8 below.
- Place an empty cup (measuring jug) underneath the font that is to be calibrated.
- Press and hold a font button until you get the right amount of water. The water do not have to be dispensed in a single push - if the button is pressed few times the overall time will be used.
- Do the same action with the other font if needed. If only one font is calibrated, settings for the other will not be altered.
- The minimum time possible for the time dispense operation is 1s. Setting the dispense time for less (quick font button click) will set the font back into "push & hold" mode.
- After the volumes are set properly press the tactile button on the timer board once again.
- Both pumps will turn on and off for 0.1s twice - that will be heard as a double click meaning that the timer is out of calibration.
- Please note that there is no given order which font is to be calibrated first - in fact they may be calibrated at once or only one may be calibrated (leaving the settings of the other unaltered).
- If there is no response from the user in the calibration mode (none of the font buttons pressed) for more than 25 seconds the timer will end the calibration (double pump "click" will be heard).
- The maximum allowable time of dispense is 25 seconds. Any longer times will be cut down to 25 seconds.
- The resolution of the time measurement is 0.1s.
- The timer board has its own clock on board therefore power line frequency is not used to measure the time.

Setting time dispense for right hand side pump (3 font version only)

- Press and release Power and ECO buttons simultaneously.
- User setup screen will appear on the display.
- Click Power button to highlight TIME DISP option.
- Use ECO button to increase value (button can be held for repeated increase). Once the value goes above the max value 99.9s it will reset to 0 and start incrementing from that value.
- Setting dispense time to 0 will make the pump work in push-and-hold mode.
- Once you set new dispense time use Power button to scroll through other options until you find SAVE AND EXIT and press ECO button to accept.
- Machine will reset and go back into main screen.

Ecosmart Features :

The Ecosmart boiler has many settable features which gives the operator great flexibility in choosing how the unit will operate. The following explains how the various features may be changed and their function.

There are 2 Menus in the Ecosmart Boiler:

- 1 is to set the Boiler User settings and
- 1 is to set the Service/Maintenance parameter,

HOW TO SETUP AN ECOSMART:

Smart Boiler (software Revision 1.10)

- After few seconds the display will show the main screen:

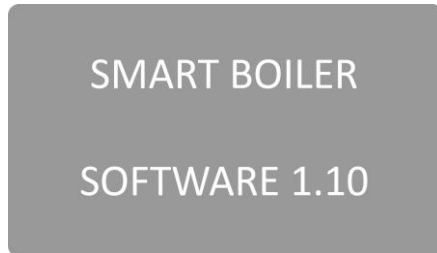

Welcome screen with version number



main screen

- Top part of the display always shows live read-out of the tank temperature (0.5°C accuracy).
- Bottom part shows current machine status.

Entering Setup Mode

- To enter setup mode press **power** and **eco** buttons on the front panel at the same time.
- The display will show "USER SETUP" message:

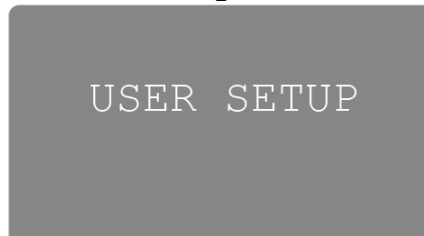



- Release the buttons now to enter the user setup mode.
- To enter advanced settings keep the buttons pressed until the display shows "SERVICE SETUP" message and release them.





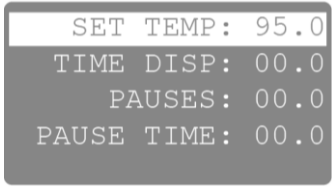
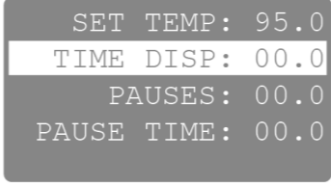
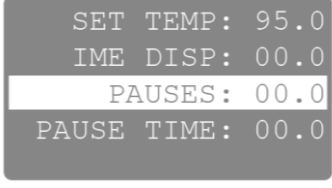
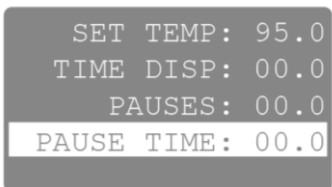

- In both setup modes use front panel buttons to navigate the settings:
 - power** button to scroll through the functions,
 - eco** button to increase set value (press and hold for auto-repeat).

USER SET UP OPTIONS:

User Setup

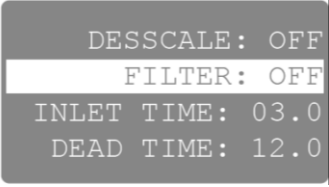
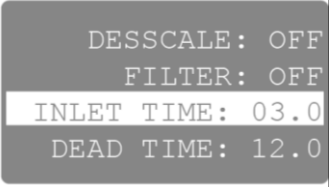
Screen view	Description	Default value
	Sets new tank temperature. Range: 60 – 99.5 °C Resolution: 0.5 °C	95.0
	Sets dispense time. Range: 0 – 99.9 seconds Resolution: 0.1 second For PUSH & HOLD mode set to 0 (default).	00.0
	Sets number of pauses during time dispense. Range: 0 – 20 If machine set as PUSH & HOLD then number of pauses has no impact on dispense.	00
	Sets pause time (same for each of the pauses). Range: 0 – 20.0 seconds Resolution: 0.1 second If machine set as PUSH & HOLD then time of pause has no impact on dispense.	00.0
	Press the eco button to save all the values and reset the machine.	-

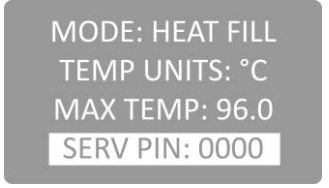
SERVICE SETUP OPTIONS:

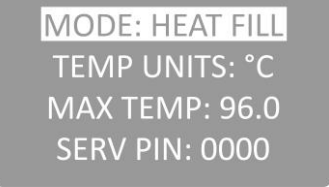
Screen view	Description	Default value
	<p>No. 1 Sets and shows remaining weeks before de-scaling is needed (“DESCALE TANK” message on the screen). Setting it to OFF will disable the function. Range: 1 – 60 weeks</p>	OFF
	<p>No. 2 Sets and shows remaining litres of water before filter change is needed (“CHANGE FILTER” message on the screen). Setting it to OFF will disable the function. Range: 100 – 9900 litres</p>	OFF
	<p>No. 3 Sets the time for which the inlet opens every time the machine needs water. It minimises temperature fluctuations. The value should be picked to allow 0.5 - 1°C cooling after water intake and depends on the tank size and element power. This is a factory setting and should only be changed by trained personnel. Range: 0 – 20.0 seconds Resolution: 0.1 second</p>	3.0 (2.8kW) 6.0 (5.6kW) 9.0 (8.4kW)
	<p>No. 4 Sets the time at which machine waits for the water too cool down after water intake. Measured from the beginning of the water intake. The value depends on tank size and element power. This is a factory setting and should only be changed by trained personnel. Range: 0 – 60.0 seconds Resolution: 0.5 second</p>	12.0
	<p>No. 5 “SERV PIN” limits access to SERVICE SETUP, setting it to 0000 disables the pin (default)</p>	OFF
	<p>No. 6 PIN entry screen - once PIN is set and user wants to access SERVICE SETUP this screen will pop up; use top button to move through positions and bottom to scroll through the values (0 to 9 and again 0); if PIN is accepted you will gain access to the SERVICE SETUP, if PIN is rejected machine will reset itself.</p>	
	<p>No. 7 Sets the mode the machine works in:</p> <ul style="list-style-type: none"> HEAT FILL (default – minimises temperature fluctuations), CONT FILL (continuous fill – makes sure the tank is always full but temperature may vary), 	HEAT FILL

	<ul style="list-style-type: none"> • COOL FILL (allows cooling but reduces tank size by using ECO mode), • MANUAL (manual filling). • See further explanations pg 8 	
<p>MODE: HEAT FILL TEMP UNITS: °C MAX TEMP: 96.0 SERV PIN: 0000</p>	No. 8 Sets temperature units on screen.	Celsius
<p>MODE: HEAT FILL TEMP UNITS: °C MAX TEMP: 96.0 SERV PIN: 0000</p>	No.9 This sets max limit of the temperature that user can set in USER SETUP; max value is 98.5 deg C	Celsius
<p>SAVE AND EXIT</p>	No.10 Press the eco button to save all the values and reset the machine.	-

DISPLAY INFORMATION DESCRIPTIONS:

Status	Description
BOILER OFF	Machine off. Display backlight off but temperature read-out still working.
FILLING ...	Water level below low level probe. Machine is filling automatically. Status LED – 2 red blinks.
FILL THE TANK	Water level below low level probe. Machine has to be refilled manually (shown only in MANUAL mode). Status LED – 2 red blinks.
WAIT ...	Water is being heated. Dispense valve disabled.
BOILER READY	Water is up to the temperature and can be used. Note that this only means that the tank is heated and not that it is full. Status LED – green.
DISPENSE	Water is being dispensed. If machine is set to time dispense – there will also be a progress bar drawn underneath. Dispense can always be cancelled by clicking the dispense button again.
COOLING ...	Machine was set by the user to a lower temperature than the current tank temperature and is trying to cool down by taking in more cold water. This process may take between 20 seconds to a few minutes depending on tank size and temperature difference. Works only in COOL FILL mode.
DISPENSE WATER TO COOL THE TANK	Machine can not take more cold water to cool the tank because it is full. Water needs to be dispensed to allow room for more cold water to come in and finish cooling process.

DESCALE TANK	Descal timer elapsed. Time to descale the tank.
CHANGE FILTER	Litres output exceeds set value. Time to change the water filter.
CHECK LOW PROBE	Low water level probe broken (disconnected). Machine detects high level probe signal but can not detect low level one. Filling is disabled. Status LED – 1 red flash.
THERMISTOR S/C	Temperature sensor (thermistor) is short circuited. Dispense and heater disabled. Status LED – 3 red flashes.
ELEMENT FAILURE	Heating element is broken. Error is triggered when after 20 minutes of heating and not taking in water temperature in the tank fails to increase. Dispense is disabled. Status LED – 4 flashes.
THERMISTOR O/C	Temperature sensor (thermistor) is disconnected. Dispense and heater disabled. Status LED – 5 red flashes.
LOW PRESSURE	Incoming water pressure too low. The error will be reset after water supply restores. All boiler functions are active. Status LED – 6 flashes.
COMM ERROR	Display board lost communication with boiler PCB (can not receive serial data about temperature and probes). All actions cancelled.

Modes of Operations [Service setup setting 5]:

Modes of OPERATION- This boiler can operate in 3 different modes.

HEAT FILL – Standard operation the boiler will take in water until the temperature in the tank drops, the inlet will close and the heating element is activated. When the temperature reaches the set temperature the inlet will reopen to take in more water. This cycle will continue until the Tank is Full. This mode is used to ensure that the water temperature is controlled within set values.

CONTINUOUS MODE – In this mode the boiler will take in water and activate the element until the tank is full and the temperature has reached the set temperature. Typically used in high demand situations where the temperature stability is not primary concern.

COOL MODE – In this mode the temperature can be adjusted up or down [function 1.] while in operation. Depending on the water level in the tank selecting a lower temperature will cause either a message to “DISPENSE WATER TO COOL THE TANK” or will automatically take in cooler water to reduce the temperature to the new set temperature. In applications where selecting different temperatures frequently is required this Cool Mode is best selected.

Note in the Cool Mode will cause the 10L boiler to operate as a 5L boiler and cause the 4L boiler to operate at 2L.

MANUAL FILL – if the boiler is not plumbed into a water supply the operator must select Manual Fill mode for best operation of the boiler. In this mode the water is added manually by the operator.

ECO Mode Operation:

Note In the COOL FILL mode [see Service setup setting 5] the ECO Mode is automatically selected.

- All ECO Boilers use high grade insulation and it is applied to give a significant energy usage improvement over a standard water boiler.
- The under counter range incorporates a ½ tank 'ECO mode' function.
- To enable the 'ECO Mode' press the button located below the 'Ready' indicator so that the leaf symbol illuminates green.
- This mode saves energy by mimimising the energy wasted during machine down-time.
- NOTE: The ECO mode is most effective in installations where the machine has a regular 'off' period.
- To achieve the most benefit from the energy saving 'ECO Mode' on your ECO boiler unit (10L variants only), the following method should be employed:
 - Towards the end of the boilers operating period for a given day, switch the machine to ECO Mode. Whilst maintaing water at 96°C, the machine tank will slowly drop to half full, where it will remain.
 - At the end of the machines operating period it should the be turned 'off'.
 - During the 'off' period as there is less water in the tank there will be less energy lost to the surrounding environment resulting in an energy saving.
- To disable simply press the 'ECO Mode' button again so that the leaf symbol is not illuminated

TROUBLESHOOTING:

The Ready/Status light signals various errors or problems. A cycle of red flashes indicates an error. The number of flashes in a cycle corresponds to the symptom in the table below:

Status/Diagnostic light guide:

No of flashes	Symptom	Action required
2	Water level below elements. Normal when machine first fills.	Check water pressure , if this is OK then call service agent.
3	Temperature sensor failure (o/c)	Call service agent
4	Water not heating	Call service agent
5	Temperature sensor failure (s/c)	Call service agent
6	Machine not filling	Check water pressure, if OK then call service agent.

Access:

Ball Valve on each front connection is shipped in the closed position.

The third front connection only exists on "A" suffix part numbers.

US variants do not require ball valve connection

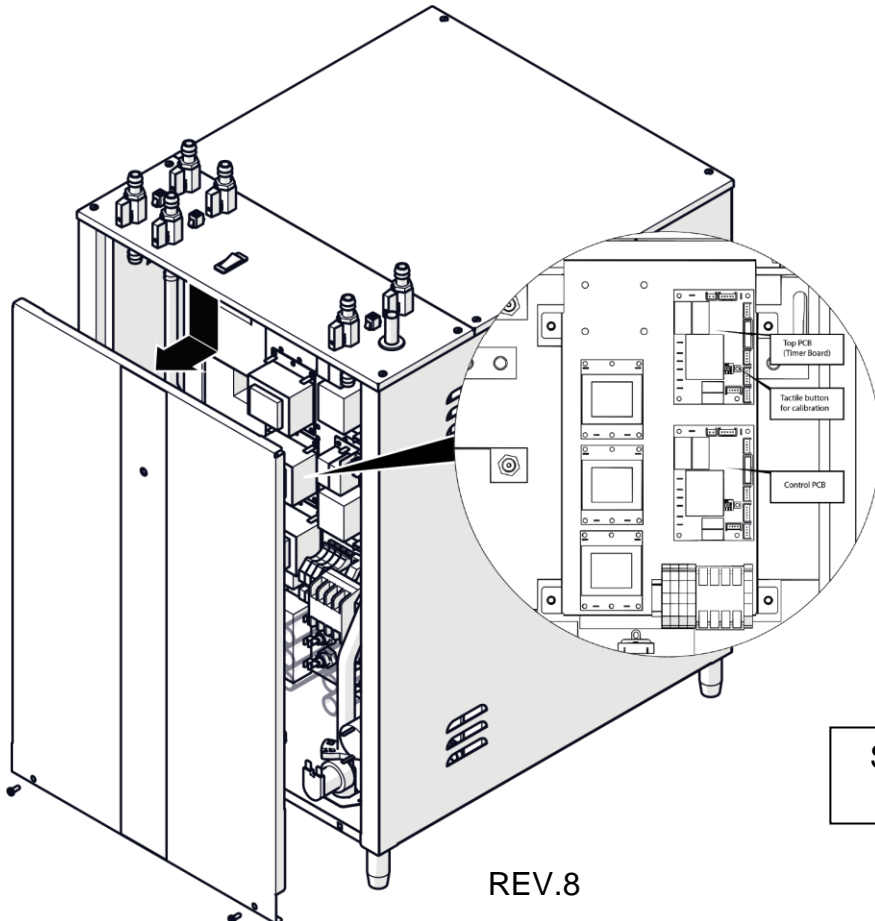
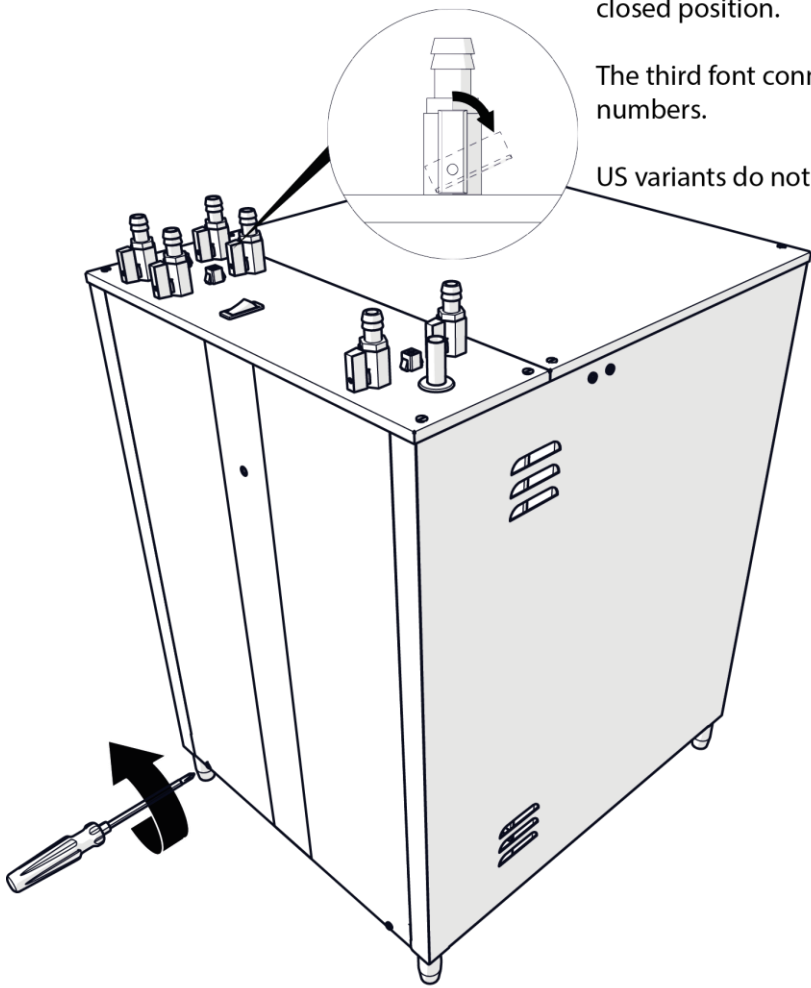

Slide down panel and pull out from bottom

Cleaning:

The exterior of these machines may be cleaned with a damp cloth and a light detergent. Do not use abrasive cloths or creams, as this will spoil the finish of the machine. Do not use a water jet or spray. Beware of accidentally operating the draw off tap when cleaning the front of the machine.

Limescale:

In common with all water boiler manufacturers, service calls resulting from limescale are not covered by warranty. Fitting a scale reducer is recommended, especially in hard water areas. This can reduce the build-up of scale but may not stop it altogether. The frequency that descaling is required depends on the local water supply; hard water areas need more attention. A scale reducer can reduce the build up of scaling, but may not stop it altogether. Descaling of the machine should ideally be carried out by qualified service personnel.

Cautions and safety tips:

- This appliance must be earthed.
- Risk of flooding. The hose supplied with this unit is non-toxic food quality tested to 190psi. However, a hose is not a permanent connection. It is, therefore, advisable to switch off boiler and close the stopcock valve when boiler is not in use, e.g. overnight, weekends etc.
- Risk of scalding. Beware of accidentally pressing the font buttons while cleaning the fonts.

The utmost care has been taken in the manufacture and testing of this unit. Failure to install, maintain and / or operate this boiler according to the manufacturer's instructions may result in conditions that can cause injury or damage to property. If in any doubt about the serviceability of the boiler always contact the manufacturer or your own supplier for advice.

Maintenance:

Marco machines have been designed to give many years of trouble free service. The only regular maintenance required is occasional de-scaling.

- Isolate machine from power supply.
- Isolate machine from water supply.
- **ALLOW TO COOL COMPLETELY!**
- Remove the front panel and drain water from machine using the detachable silicon hose running down the front side of the machine.
- Remove lid.
- Remove as much scale as possible by hand, paying particular attention to level probes (White plastic with steel tab). Be very careful not to damage any attachments.
- Use ScaleKleen, Marco part No. 8000270 or similar. Follow instructions carefully.
- Thoroughly clean and flush the machine before re-use.
- Follow installation and first time operation instructions

Font Connection:

Figure shows the typical connection method for connecting font(s) to the UnderCounter Boiler. Refer to the Font instructions which accompanied the Font unit for more details.

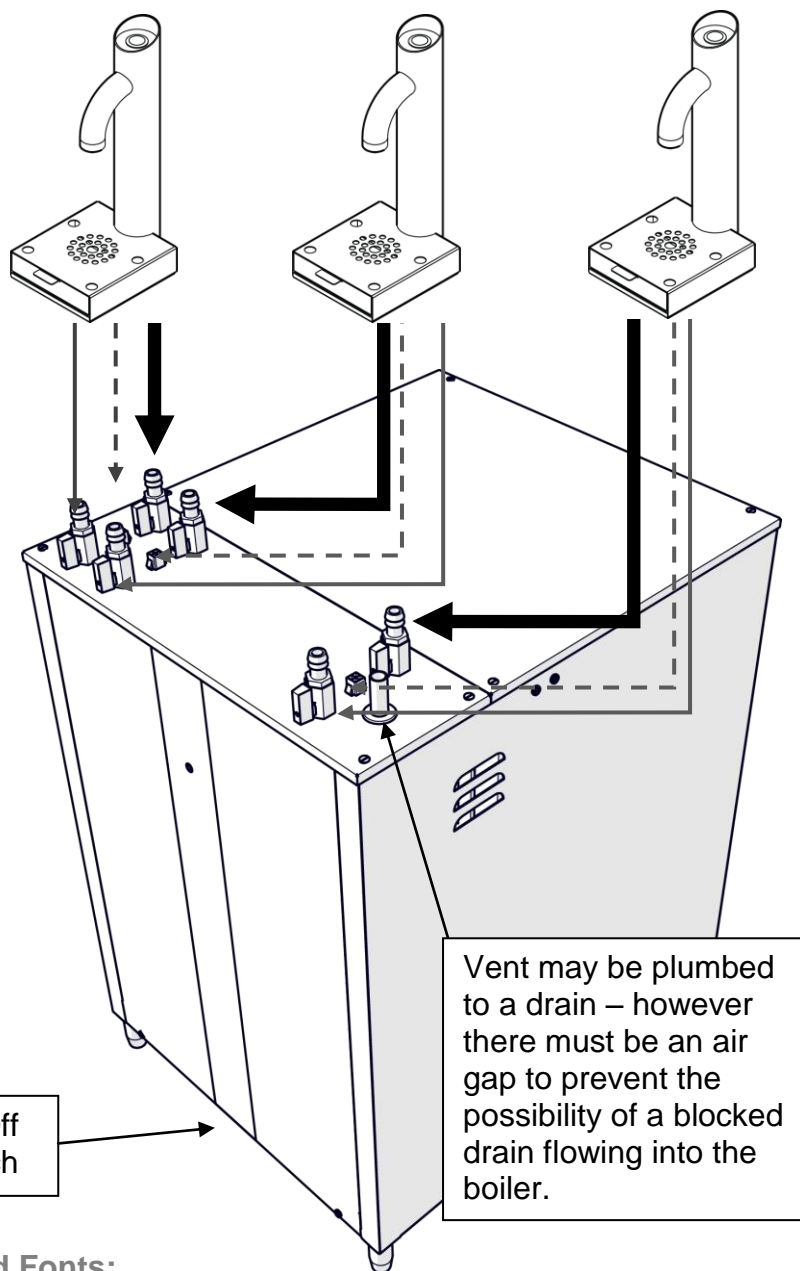

Fonts will vary.

Depending on font the type the drip tray will either have to be manually emptied

or

Connected to a drain via drip tray outlet.

--- 2- wire
--- Electrical
--- Connection
--- Font to Boiler

| Font Water
| Connection.

█ Font
█ Recirculation
█ Connection

**Only machines
with the "A" suffix
will have 3 font
connections.**

Standard Fonts:

- Connect the clear hose to the water connection, shown above. Open ball valve fully.
- Connect the cable from the font to the electrical connection, as above.
- Recirculation connection must be closed at all times.

Recirculating Fonts:

- Insure your boiler is configured for a recirculating font.
- Connect grey hose from font to the recirculation connection, shown above.
- Connect the clear hose to the water connection, shown above. Open ball valve fully.
- Connect the cable from the font to the electrical connection, as above.
- Make sure the two hoses are straight and free of kinks.
- Adjust the ball valve on the recirculating connection to get desired flow rate from the font.

Font Connection:

Figure shows the typical connection method for connecting font(s) to a US under counter boiler. Refer to the Font instructions which accompanied the Font unit for more details.

Fonts will vary.

Depending on font the type the drip tray will either have to be manually emptied

or

Connected to a drain via drip tray outlet.

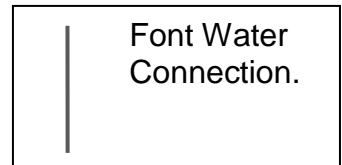
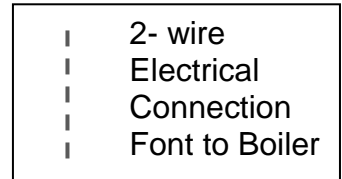
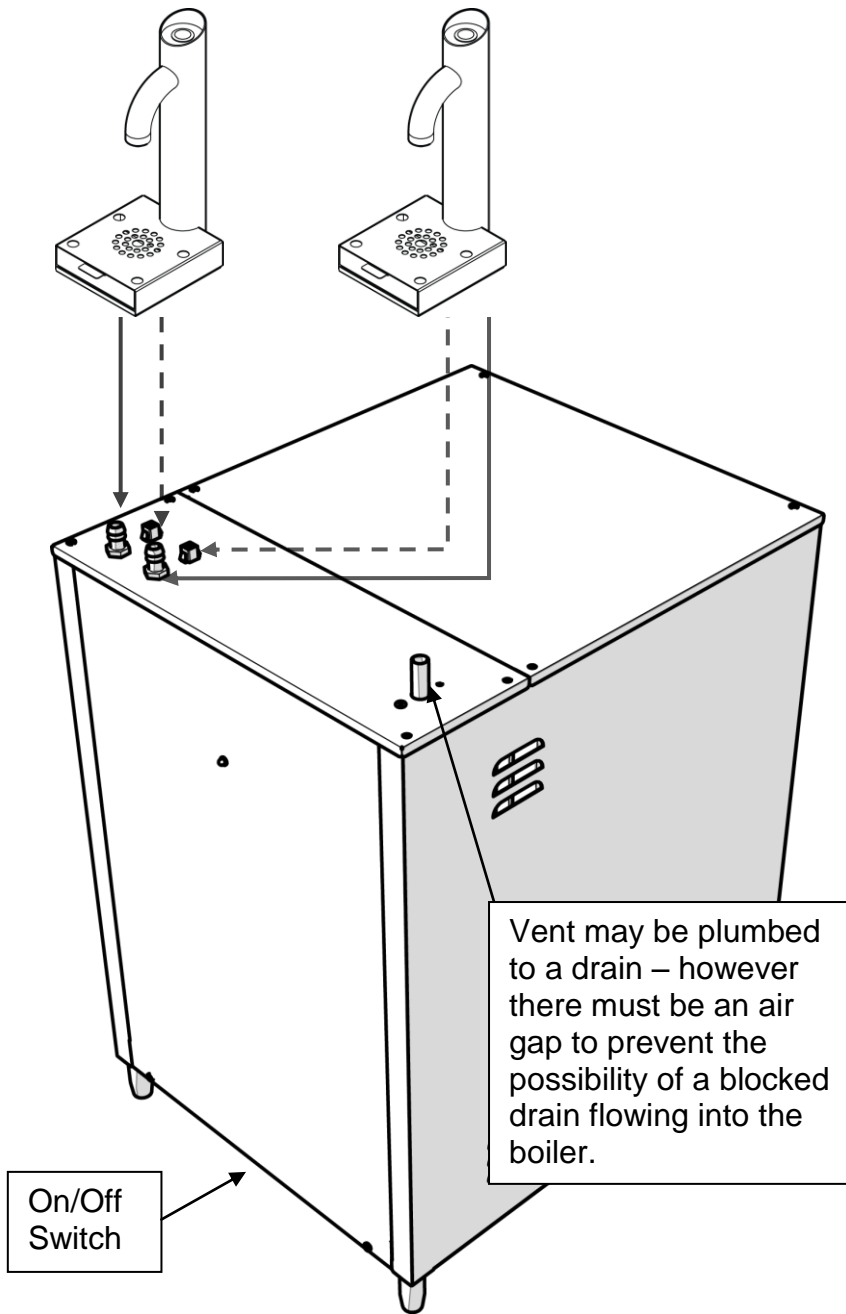

Standard Fonts:

- Connect the clear hose to the water connection, shown above.
- Connect the cable from the font to the electrical connection, as above.

