



SNACK

GAS-HEATED CHARCOAL-GRILL

INSTRUCTIONS FOR INSTALLATION, OPERATION AND MAINTENANCE

Read the general informations immediately!

GB – IE – MT

DOC.NO CR0930040
EDITION 001

SCHEMA DI INSTALLAZIONE - INSTALLATION DIAGRAM - INSTALLATIONSPLAN - SCHÉMA D'INSTALLATION - ESQUEMA DE INSTALACION -INSTALLATIESCHEMA - IINSTALLATIONSRIITNINGAR

MISURE IN mm - DIMENSIONS IN mm - ABMESSUNGEN IN mm
 MESURES EN mm - MEDIDAS EN mm - MATEN IN mm

GPL64G	OGPL64G
6NGL/G400	EGL62T

GPL68G	OGPL68G
6NGL/G800	EGL64T

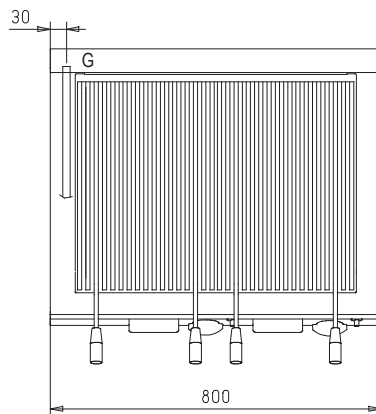
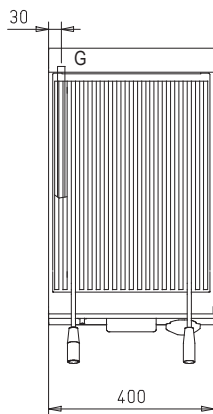
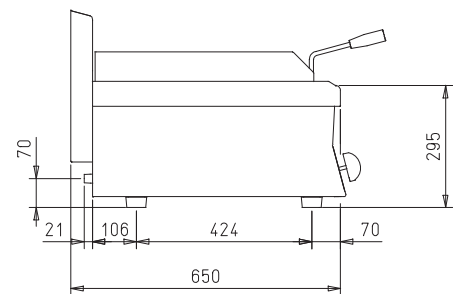
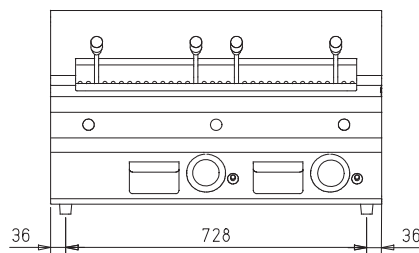
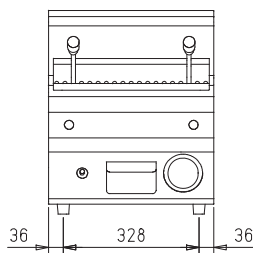

Legenda - Legende - Key - Legende - Leyenda - Legenda - Legenda

G Attacco arrivo gas - Gasanschluss - Gas connection
 Arrivée gaz - Union da gas - Gasaansluiting -
 EN 10226-1 R 1/2; EN ISO 228-1 G 1/2 (DK)

DATI TECNICI - TECHNICAL DATA - TECHNISCHE DATEN - CARACTERISTIQUES TECHNIQUES - DATOS TECNICOS - TECHNISCHE GEGEVENS

T1							
Ugelli e regolazioni - Düsen und Einstellungen - Nozzles and settings							
Buses et les paramètres - Boquillas y los ajustes - Nozzles en instellingen							
Paese - Land Country - Pays - País	Gas - Gaz	Pa (mbar)		GPL64G	EGL62T	OGPL64G	6NGL/G400
				GPL68G	EGL64T	OGPL68G	6NGL/G800
AT - BE - BG - CH - CZ - DE DK - EE - ES - FI - FR - GB GR - HR - IE - IT - LT - LU LV - NO - PL - PT - RO - SE SI - SK - TR	G20 G20/G25	20 20/25	UM	205	205	205	205
			P	27	27	27	27
			A (mm)	0	0	0	0
			Um	140	140	140	140
DE	G25	20	UM	220	220	220	220
			P	27	27	27	27
			A (mm)	0	0	0	0
			Um	140	140	140	140
NL	G25	25	UM	205	205	205	205
			P	27	27	27	27
			A (mm)	0	0	0	0
			Um	140	140	140	140
HU	G20	25	UM	190	190	190	190
			P	27	27	27	27
			A (mm)	0	0	0	0
			Um	140	140	140	140
HU	G25.1	25	UM	220	220	220	220
			P	27	27	27	27
			A (mm)	0	0	0	0
			Um	140	140	140	140
BE - BG - CY - CZ - DK - EE ES - FI - FR - GB - GR - HR HU - IE - IT - LT - LU - LV MT - NL - NO - PT - RO - SE SI - SK - TR	G30/G31	28-30/37 28-30	UM	130	130	130	130
			P	14	14	14	14
			A (mm)	0	0	0	0
			Um	90	90	90	90
PL	G30/G31	37	UM	125	125	125	125
			P	14	14	14	14
			A (mm)	0	0	0	0
			Um	90	90	90	90
AT - CH - DE - HU	G30/G31	50	UM	115	115	115	115
			P	14	14	14	14
			A (mm)	0	0	0	0
			Um	90	90	90	90
IT - CH - SE - DK	G110	8	UM	480	480	480	480
			P	50	50	50	50
			A (mm)	0	0	0	0
			Um	reg	reg	reg	reg
SE	G120	8	UM	420	420	420	420
			P	50	50	50	50
			A (mm)	0	0	0	0
			Um	reg	reg	reg	reg

UM : Ugello MAX - Düse MAX - MAX nozzle - Buse MAX - Boquilla MÁX. - Sproeier MAX
Um : Ugello MIN - Düse MIN - MIN nozzle - Buse MIN - Boquilla MIN - Sproeier MIN
P : Pilota - Zündbrenner - Pilot - Veilleuse gaz - Piloto - Waakvlam
A : Apertura Aereatore - Öffnen Luftring - Aerator Opening - Ouverture Aérateur - Abertura del aireador - Opening beluchter
Pa : Pressione di allacciamento - Anschlussdruck - Supply pressure
 Pression de raccordement - Presión de conexión - Aansluitdruk
reg : Regolato - Eingestellt - Regulated - Régie - Regulado - Geregeld

DATI TECNICI - TECHNICAL DATA - TECHNISCHE DATEN - CARACTERISTIQUES TECHNIQUES - DATOS TECNICOS - TECHNISCHE GEGEVENS

T2					
Categorie a pressioni - Kategorien e Druck - Categories and pressures - Catégories et pressions - Las categorías y las presiones - Categoríeën en druk					
Paese - Land - Country - Pays - País	Categoria Kategorie Category Catégorie Categoría Categoríe	Gas Gaz	Pressione di allacciamento Anschlussdruck Supply pressure Pression de raccordement Presión de conexión Aansluitdruk (mbar)		
			Nom. Neen. Norm. Normal	Min.	Max.
LU; PL	I2E	G20	20	17	25
NO	I2H	G20	20	17	25
NL	I2L	G25	25	20	30
LU	I3+	G30/G31	28-30/37	20/25	35/45
NO; NL; CY; MT	I3B/P	G30/G31	28-30	25	35
PL	I3B/P	G30/G31	37	25	45
BE; FR	II2E+3+	G20/G25	20/25	17	25/30
		G30/G31	28-30/37	20/25	35/45
DE	II2ELL3B/P	G20	20	17	25
		G25	20	18	25
		G30/G31	50	42,5	57,5
ES; GB; GR; IE; IT; PT; SK	II2H3+	G20	20	17	25
		G30/G31	28-30/37	20/25	35/45
FI; BG; EE; LV; LT; CZ; SI; TR; HR; RO	II2H3B/P	G20	20	17	25
		G30/G31	28-30	25	35
AT; CH	II2H3B/P	G20	20	17	25
		G30/G31	50	42,5	57,5
HU	II2HS3B/P	G20	25	18	33
		G25.1	25	18	33
		G30/G31	28-30	25	35
HU	II2HS3B/P	G20	25	18	33
		G25.1	25	18	33
		G30/G31	50	42,5	57,5
SE	III1ab2H3B/P	G20	20	17	25
		G30/G31	28-30	25	35
		G110	8	6	15
		G120	8	6	15
DK	III1a2H3B/P	G20	20	17	25
		G30/G31	28-30	25	35
		G110	8	6	15
IT; CH	II1a2H	G20	20	17	25
		G110	8	6	15

Dati tecnici apparecchiature gas - Technische Daten gasgeräte - Technical data of gas appliances
 Caractéristiques techniques des appareils à gaz - Datos técnicos de los equipos de gas - Technische gegevens gasapparaten

Modelli Modelle Models Modèles Modelos Modellen A	Modelli Modelle Models Modèles Modelos Modellen B	Modelli Modelle Models Modèles Modelos Modellen C	Modelli Modelle Models Modèles Modelos Modellen D	Larghezza Breite Width Largeur Anchura Breedte	5 kW	Consumo gas complessivo - Gasamtgasverbrauch - Totala gas consumption Consommation totale de gaz - Consumo total de gas - Totaal gasverbruik									
						G20 (20) m3/h	G25 (25) m3/h	G25 (20) m3/h	G20 (25) m3/h	G25.1 (25) m3/h	G110 (8) m3/h	G120 (8) m3/h	G30 (29) kg/h	G30 (37) kg/h	G30 (50) kg/h
GPL64G	EGL62T	OGPL64G	6NGL/G400	400	7	0,74	0,86	0,86	0,74	0,86	1,81	1,61	0,55	0,55	0,55
GPL68G	EGL64T	OGPL68G	6NGL/G800	800	14	1,48	1,72	1,72	1,48	1,72	3,61	3,21	1,10	1,10	1,10

FIGURE - ABB. - FIG.

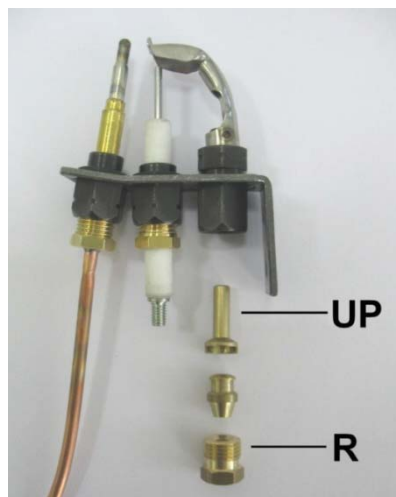
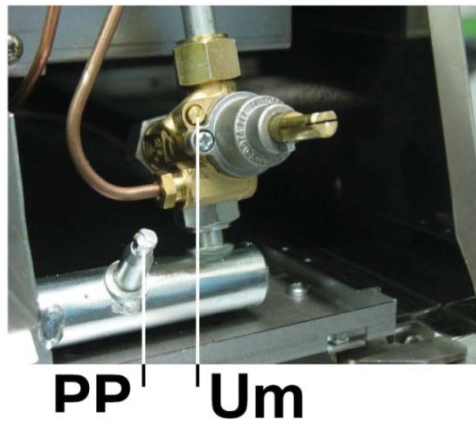
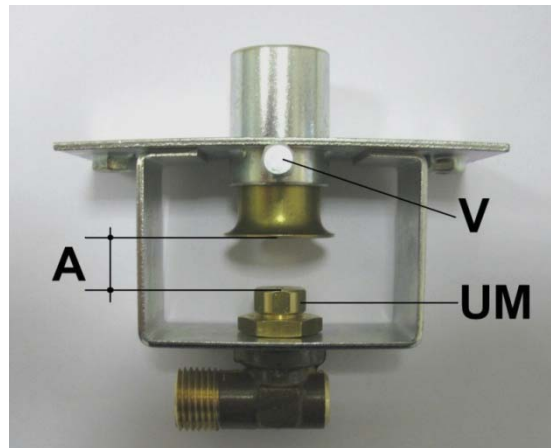

GENERAL INFORMATION.....	19
1 APPLIANCE SPECIFICATIONS	19
2 GENERAL PRESCRIPTIONS	19
REMINDEES FOR THE INSTALLER	19
REMINDEES FOR THE USER	19
REMINDEES FOR THE MAINTENANCE TECHNICIAN	19
REMINDEES FOR CLEANING	19
3 DISPOSAL OF PACKING AND THE APPLIANCE	19
INSTRUCTIONS FOR INSTALLATION	19
REMINDEES FOR THE INSTALLER	19
4 REFERENCE STANDARDS AND LAWS.....	20
5 UNPACKING	20
6 POSITIONING.....	20
7 FUMES EXHAUST SYSTEM.....	20
8 CONNECTIONS.....	20
9 GAS LAVA STONE GRILL	20
10 COMMISSIONING	21
INSTRUCTIONS FOR USE.....	21
REMINDEES FOR THE USER	21
11 POSITIONING THE GRILLES	21
12 USING THE GAS LAVA STONE GRILL.....	21
13 PROLONGED DISUSE.....	21
INSTRUCTIONS FOR CLEANING.....	22
REMINDEES FOR CLEANING	22
14 GAS LAVA STONE GRILL	22
INSTRUCTIONS FOR MAINTENANCE	22
REMINDEES FOR THE MAINTENANCE TECHNICIAN	22
15 CONVERSION TO A DIFFERENT TYPE OF GAS.....	22
16 COMMISSIONING	22
17 TROUBLESHOOTING	22
17.1 GAS LAVA STONE GRILL	22
18 REPLACING COMPONENTS.....	22
REMINDEES FOR REPLACING COMPONENTS.....	22
18.1 GAS LAVA STONE GRILL	23
19 CLEANING THE INTERIOR	23
20 MAIN COMPONENTS	23
20.1 GAS LAVA STONE GRILL	23

GENERAL INFORMATION

This chapter contains general information which all users of the manual must be familiar with. Specific information for individual users of the manual is provided in subsequent chapters (" INSTRUCTIONS FOR ").

1 APPLIANCE SPECIFICATIONS

- The appliance data plate is located inside the control panel.
- The appliance model and serial number are also detailed on decals under the brand logo and on the packing.

2 GENERAL PRESCRIPTIONS

The manufacturer will not be liable for any damage or injury resulting from failure to observe the following rules

REMINDERS FOR THE INSTALLER

- Read this manual carefully. It provides important information for safe installation, use and maintenance of the appliance.
- Installation, conversion to a different type of gas and appliance maintenance must be carried out by qualified technicians authorized by the manufacturer, in compliance with current safety standards and the instructions in this manual.
- Identify the specific appliance model. The model number is detailed on the packing and on the appliance data plate.
- The appliance must be installed in a well-ventilated room.
- Do not obstruct any air vents or drains present on the appliance.
- Do not tamper with appliance components.

REMINDERS FOR THE USER

- Read this manual carefully. It provides important information for safe installation, use and maintenance of the appliance.
- Keep this manual in a safe place known to all users so that it can be consulted throughout the working life of the appliance.
- Installation, conversion to a different type of gas and appliance maintenance must be carried out by qualified technicians authorized by the manufacturer, in compliance with current safety standards and the instructions in this manual.
- For after-sales service, contact technical assistance centers authorized by the manufacturer and demand the use of original spare parts.
- Have the appliance serviced at least twice a year. The manufacturer recommends taking out a service contract.
- The appliance is designed for professional use and must be operated by trained personnel.
- The appliance is to be used for cooking food as specified in the reminders for use. Any other use must be considered improper
- Do not allow the appliance to operate empty for prolonged periods. Only pre-heat the oven just before use.
- Do not leave the appliance unattended while in operation.
- In the event of an appliance fault or malfunction, shut the gas shut-off valve and/or switch the appliance off at the main switch installed upline.
- Clean the appliance following the instructions given in Chapter " INSTRUCTIONS FOR CLEANING".
- Do not store flammable materials in close proximity to the appliance. FIRE HAZARD.
- Children should be supervised to ensure that they do not play with the appliance.
- This appliance is not intended for use by persons (including children) with reduced physical, sensory or mental capabilities, or lack of experience and knowledge, unless they have been given supervision or instruction concerning use of the appliance by a person responsible for their safety.

- Do not obstruct any air vents or drains present on the appliance.
- Do not tamper with appliance components.

REMINDERS FOR THE MAINTENANCE TECHNICIAN

- Read this manual carefully. It provides important information for safe installation, use and maintenance of the appliance.
- Installation, conversion to a different type of gas and appliance maintenance must be carried out by qualified technicians authorized by the manufacturer, in compliance with current safety standards and the instructions in this manual.
- Identify the specific appliance model. The model number is detailed on the packing and on the appliance data plate.
- The appliance must be installed in a well-ventilated room.
- Do not obstruct any air vents or drains present on the appliance.
- Do not tamper with appliance components.

REMINDERS FOR CLEANING

- Clean the satin finish stainless steel exterior surfaces, the cooking wells and the surface of the hotplates every day.
- At least twice a year, have an authorized technician clean the internal parts of the appliance.
- Do not use direct or high pressure water jets to clean the appliance.
- Do not use corrosive products to clean the floor beneath the appliance.

3 DISPOSAL OF PACKING AND THE APPLIANCE

3.1 PACKING

The packing is made using environmentally friendly materials. The plastic recyclable components are:

- the transparent cover, the bags containing the instructions manual and nozzles (made of Polyethylene - PE).
- the straps (in Polypropylene - PP).

3.2 APPLIANCE

The appliance is manufactured 90% from recyclable metals (stainless steel, aluminium sheet, copper....).

The appliance must be scrapped in compliance with current regulations governing such disposal.

- It must be disposed of properly.
- Make the appliance unusable before scrapping.

INSTRUCTIONS FOR INSTALLATION

REMINDERS FOR THE INSTALLER

The manufacturer will not be liable for any damage or injury resulting from failure to observe the following rules

- Read this manual carefully. It provides important information for safe installation, use and maintenance of the appliance.
- Installation, conversion to a different type of gas and appliance maintenance must be carried out by qualified technicians authorized by the manufacturer, in compliance with current safety standards and the instructions in this manual.
- Identify the specific appliance model. The model number is detailed on the packing and on the appliance data plate.
- The appliance must be installed in a well-ventilated room.
- Do not obstruct any air vents or drains present on the appliance.
- Do not tamper with appliance components.

4 REFERENCE STANDARDS AND LAWS

Install the appliance in compliance with current safety standards.

Install the appliance in compliance with the prescriptions of EN1717 and the water pollution regulations in force in your country.

5 UNPACKING

Check the state of the packing and in the event of damage, ask the delivery person to inspect the goods.

- Remove the packing
- Remove the protective film from the external panels. Use a suitable solvent to remove any residual adhesive from the panels

6 POSITIONING

- The overall dimensions of the appliance and the position of connections are given on the installation diagram at the start of this manual.
- The appliance can be installed singly or in combination with other appliances in the same product range.
- The appliance is not suitable for integrated installation.
- Position the appliance at least 10 cm from adjacent walls. This distance can be reduced in the presence of non-combustible walls or heat-insulated walls.

6.1 APPLIANCE ASSEMBLY WITH BASE

Follow the instructions provided with the type of support utilized.

6.2 JOINING APPLIANCES TOGETHER IN LINE

- Place the appliances side by side and adjust the tops to the same height.
- Unite the appliances using the special unionjoint-coverings supplied upon request

7 FUMES EXHAUST SYSTEM

Create a fumes exhaust system based on the "Type" of appliance. The "Type" is stated on the appliance data plate.

7.1 APPLIANCE TYPE "A1"

- Position the "A1" type appliance below an extractor hood to ensure smoke and fumes generated by cooking are removed

7.2 APPLIANCE TYPE "B21"

- Position the "B21" type appliance below an extractor hood

7.3 APPLIANCE TYPE "B11"

- Fit the "B11" type appliance with a suitable flue, available from the appliance manufacturer. Follow the assembly instructions provided with the flue.
- Connect the flue to a 150/155 mm diameter hose, heat resistant to 300°C.
- Vent to the outside or into an efficient flue. The hose length must not exceed 3 metres.

8 CONNECTIONS

The position and dimensions of connections are given in the installation diagram at the start of this manual.

8.1 ELECTRICAL CONNECTIONS

Check that the appliance is designed to operate at the voltage and frequency of the power supply present on site. Check the details given on the appliance data plate.

- At an easily accessible point upline of the appliance, fit an all-pole disconnect switch of suitable capacity with a contact breaking distance of at least 3 mm, and a highly sensitive differential protection device. The maximum permitted leakage current is 1 mA/kW.
- A flexible rubber cable with insulation specifications not lower than type H05 RN-F must be used for connection.
- Connect the power supply cable to the terminal board as shown in the wiring diagram supplied with the appliance.
- Secure the power supply cable with the cable clamp.
- Protect the power supply cable on the outside of the appliance with a rigid plastic or metal pipe.

8.2 PROTECTIVE EARTH AND EARTH BONDING CONNECTIONS

Connect the appliance to an efficient ground circuit. Connect the earth conductor to the terminal with the symbol  located next to the main terminal board.

Connect the metal structure of the appliance to the equipotential node. Connect the conductor to the terminal with the symbol  on the outside part of the bottom.

8.3 CONNECTION TO THE WATER SUPPLY

The appliance must be connected to a potable water supply. The water inlet pressure must be between 150 kPa and 300 kPa. Use a pressure reducer if the inlet pressure is above the maximum permitted level.

- Install a mechanical filter and a shut-off valve upstream of the appliance in an easily accessible point.
- Make sure the water circuit is free from ferrous particles before connecting the filter and the appliance.
- Seal any unused connectors with a plug.
- Once the appliance has been installed, check for gas leaks at the connection points.

8.4 CONNECTION TO THE WATER DRAIN

The water drainage system must be provided using materials resistant to temperatures of 100 °C. The bottom of the appliance must not be subjected to steam produced by drainage of hot water.

9 GAS LAVA STONE GRILL

9.1 REPLACING THE MAIN BURNER NOZZLE AND ADJUSTING THE PRIMARY AIR FLOW

- Remove the control panel.
- Unscrew nozzle UM and change it with the proper one according to Table T1.
- Loose fixing screw V and operating on the shutter adjust primary air inlet at the distance "A" indicated on Table T1.
- Screw down fixing screw V and seal it with red paint.

9.2 REPLACING THE MINIMUM ADJUSTMENT SCREW

- Remove the control panel.
- Unscrew the minimum adjustment screw Um and replace it with the proper one indicated Table T1.
- Re-assemble all parts. For assembly, proceed in reverse order.

9.3 REPLACING THE PILOT BURNER NOZZLE

- Remove the control panel.
- Undo connector R.
- Remove nozzle UP and replace it with the one indicated in table T1.
- Retighten the connector R. Re-assemble all parts.
- For assembly, proceed in reverse order.

10 COMMISSIONING

See Chapter " INSTRUCTIONS FOR MAINTENANCE "

INSTRUCTIONS FOR USE

REMINDERS FOR THE USER

The manufacturer will not be liable for any damage or injury resulting from failure to observe the following rules

- Read this manual carefully. It provides important information for safe installation, use and maintenance of the appliance.
- Keep this manual in a safe place known to all users so that it can be consulted throughout the working life of the appliance.
- Installation, conversion to a different type of gas and appliance maintenance must be carried out by qualified technicians authorized by the manufacturer, in compliance with current safety standards and the instructions in this manual.
- For after-sales service, contact technical assistance centers authorized by the manufacturer and demand the use of original spare parts.
- Have the appliance serviced at least twice a year. The manufacturer recommends taking out a service contract.
- The appliance is designed for professional use and must be operated by trained personnel.
- The appliance is to be used for cooking food as specified in the reminders for use. Any other use must be considered improper
- Do not allow the appliance to operate empty for prolonged periods. Only pre-heat the oven just before use.
- Do not leave the appliance unattended while in operation.
- In the event of an appliance fault or malfunction, shut the gas shut-off valve and/or switch the appliance off at the main switch installed upline.
- Clean the appliance following the instructions given in Chapter " INSTRUCTIONS FOR CLEANING".
- Do not store flammable materials in close proximity to the appliance. FIRE HAZARD.
- Do not obstruct any air vents or drains present on the appliance.
- Do not tamper with appliance components.
- Children should be supervised to ensure that they do not play with the appliance.
- This appliance is not intended for use by persons (including children) with reduced physical, sensory or mental capabilities, or lack of experience and knowledge, unless they have been given supervision or instruction concerning use of the appliance by a person responsible for their safety.

Important: To avoid flames, always remove any deposits of food, dirt or oil left over from the previous cooking cycles before switching on the appliance.

11 POSITIONING THE GRILLES

FISH GRID

- The cooking grille can be used in two positions: sloping or horizontal.

CAST IRON GRILLES FOR MEAT

- The cooking grille can be used in two positions: sloping or horizontal.

STAINLESS STEEL GRILLES FOR MEAT

- The cooking grille can be used in positions sloping.

12 USING THE GAS LAVA STONE GRILL

REMINDERS FOR USE

- The appliance is designed for cooking foods directly on the grille (steaks, hamburgers, fish, vegetables, etc.).
- The grill must not be used to heat pans or saucepans.

Loading the lava stone

- The appliances come complete with 1 packs of lava stone for each brazier (cooking zone).
- Each pack weighs 6 kg.
- The lava stones have a min. diameter of 25mm, a max. diameter of 30mm and a max. length of 50mm, with a +/- 5% tolerance.
- Distribute the contents of one pack evenly between the braziers. Do not under any circumstances use more lava stone than recommended.

Grease collection tray

Any grease from cooking which drips into the grill and passes through the brazier is collected in the grease collection tray. Periodically empty and clean this tray.

BURNER IGNITION AND EXTINCTION

The gas tap control knob has the following positions:

● Off

★ Pilot ignition

🔥 Minimum flame

🔥 Maximum flame

Pilot ignition

Press and turn the knob to position " ★ ". Press the knob down fully and light the pilot using the piezoelectric igniter.

- Hold the knob down for about 20 seconds before releasing it. If the pilot flame goes out, repeat the operation.

Main burner ignition

Turn the knob from position " ★ " to " 🔥 ".

Next, depending on cooking requirements, turn the knob to any position between " 🔥 " and " 🔥 ".

Switching off

To switch the main burner off, turn the knob to position " ★ ".

To switch off the pilot flame, press and turn the knob to position " ● ".

13 PROLONGED DISUSE

Before any prolonged disuse of the appliance, proceed as follows:

- Clean the appliance thoroughly.

- Rub stainless steel surfaces with a cloth soaked in Vaseline oil to create a protective film.
 - Leave lids open.
 - Shut off taps and main switches upline of appliances.
- Following prolonged disuse, proceed as follows:

- Inspect the appliance thoroughly before using it again.
- Allow electric appliances to operate at the lowest temperature for at least 60 minutes.

INSTRUCTIONS FOR CLEANING

REMINDERS FOR CLEANING

The manufacturer will not be liable for any damage or injury resulting from failure to observe the following rules

- Disconnect the appliance electric supply, if present, before carrying out any operation.
- Clean the satin finish stainless steel exterior surfaces, the cooking wells and the surface of the hotplates every day.
- At least twice a year, have an authorized technician clean the internal parts of the appliance.
- Do not use direct or high pressure water jets to clean the appliance.
- Do not use corrosive products to clean the floor beneath the appliance.

SATIN FINISH STAINLESS STEEL SURFACES

- Clean the surfaces with a cloth or sponge using water and proprietary non-abrasive detergents. Follow the direction of the satin finish lines. Rinse repeatedly and dry thoroughly.
- Do not use pan scourers or other iron items.
- Do not use chemical products containing chlorine.
- Do not use sharp objects which might scratch and damage the surfaces.

COLLECTION TRAYS

Clean the surface, removing grease, oil, food residue etc...

14 GAS LAVA STONE GRILL

- Lift up and remove the cooking grille and the brazier containing the lava stone.
- Proceed to clean the burner around the flame zone and along the flame protector apertures using a wire brush to eliminate all traces of dust, burnt-on residue and refractory material used in the brazier, whilst taking care not to enlarge the flame apertures.

INSTRUCTIONS FOR MAINTENANCE

REMINDERS FOR THE MAINTENANCE TECHNICIAN

The manufacturer will not be liable for any damage or injury resulting from failure to observe the following rules

- Read this manual carefully. It provides important information for safe installation, use and maintenance of the appliance.
- Installation, conversion to a different type of gas and appliance maintenance must be carried out by qualified technicians authorized by the manufacturer, in compliance with current safety standards and the instructions in this manual.
- Identify the specific appliance model. The model number is detailed on the packing and on the appliance data plate.
- The appliance must be installed in a well-ventilated room.
- Do not obstruct any air vents or drains present on the appliance.
- Do not tamper with appliance components.

15 CONVERSION TO A DIFFERENT TYPE OF GAS

See Chapter " Instructions for installation "

16 COMMISSIONING

Following installation, conversion to a different type of gas or any maintenance operations, check appliance operation. In the event of any malfunction, consult the next Paragraph "Troubleshooting".

16.1 GAS APPLIANCES

Switch on the appliance as directed in the instructions and reminders for use given in Chapter " INSTRUCTIONS FOR USE " and check:

- the gas supply pressure (see next Paragraph).
- the correct ignition of the burners and the effectiveness of the fumes removal system.

16.1.1 CHECKING THE GAS SUPPLY PRESSURE

- To measure the gas supply pressure use a manometer with a minimum definition of 0.1 mbar.
 - Remove the control panel.
 - Remove the screw from the pressure test point PP and connect the manometer to the test point.
 - Make the measurement with the appliance in operation.
- IMPORTANT!** If the gas supply pressure is not within the limits (Min. - Max) indicated in Table T2 , cease operation of the appliance and contact the gas utility company.

- Disconnect the manometer and retighten the retaining screw on the pressure connection.

17 TROUBLESHOOTING

17.1 GAS LAVA STONE GRILL

The pilot burner does not light

Possible causes:

- Insufficient gas supply pressure.
- Blocked tubing or nozzle.
- Defective gas tap or valve.
- Igniter defective or not properly connected.
- Igniter or igniter wire defective.

Pilot burner goes out during use

Possible causes:

- Insufficient gas supply pressure.
- Defective gas tap or valve.
- Defective thermocouple or insufficient heating.
- Thermocouple incorrectly connected to gas tap or valve.
- Knob of gas tap or valve not pressed sufficiently.

The main burner does not light (even though pilot is lit)

Possible causes:

- Defective burner (gas outlet holes clogged).

18 REPLACING COMPONENTS

REMINDERS FOR REPLACING COMPONENTS.

- Disconnect the appliance electric supply, if present, before carrying out any operation.
- After replacing a gas system component, check for gas leaks at connection points.

- After replacing an electrical system component, check it is correctly wired.

18.1 GAS LAVA STONE GRILL

Replacing the gas tap

- Remove the control panel.
- Remove and replace the component.
- Re-assemble all parts. For assembly, proceed in reverse order.

Replacing the pilot burner and thermocouple.

- Remove the control panel.
- Remove the grilles, lava stone and support brazier.
- Remove and replace the component.
- Re-assemble all parts. For assembly, proceed in reverse order.

Replacing the main burner.

- Remove the grilles, lava stone and support brazier.
- Remove and replace the component.
- Re-assemble all parts. For assembly, proceed in reverse order.

19 CLEANING THE INTERIOR

- Check the condition of the inside of the appliance.
- Remove any built-up dirt.
- Check and clean the fumes exhaust system.

20 MAIN COMPONENTS

20.1 GAS LAVA STONE GRILL

- Main burner
- Pilot burner
- Thermocouple
- Igniter
- Piezoelectric ignition
- Gas tap
- Brazier
- Volcanic lava stone