

LE PAVONI®

MACCHINE

MACHINES



LE PAVONI®

MACCHINE
MACHINES

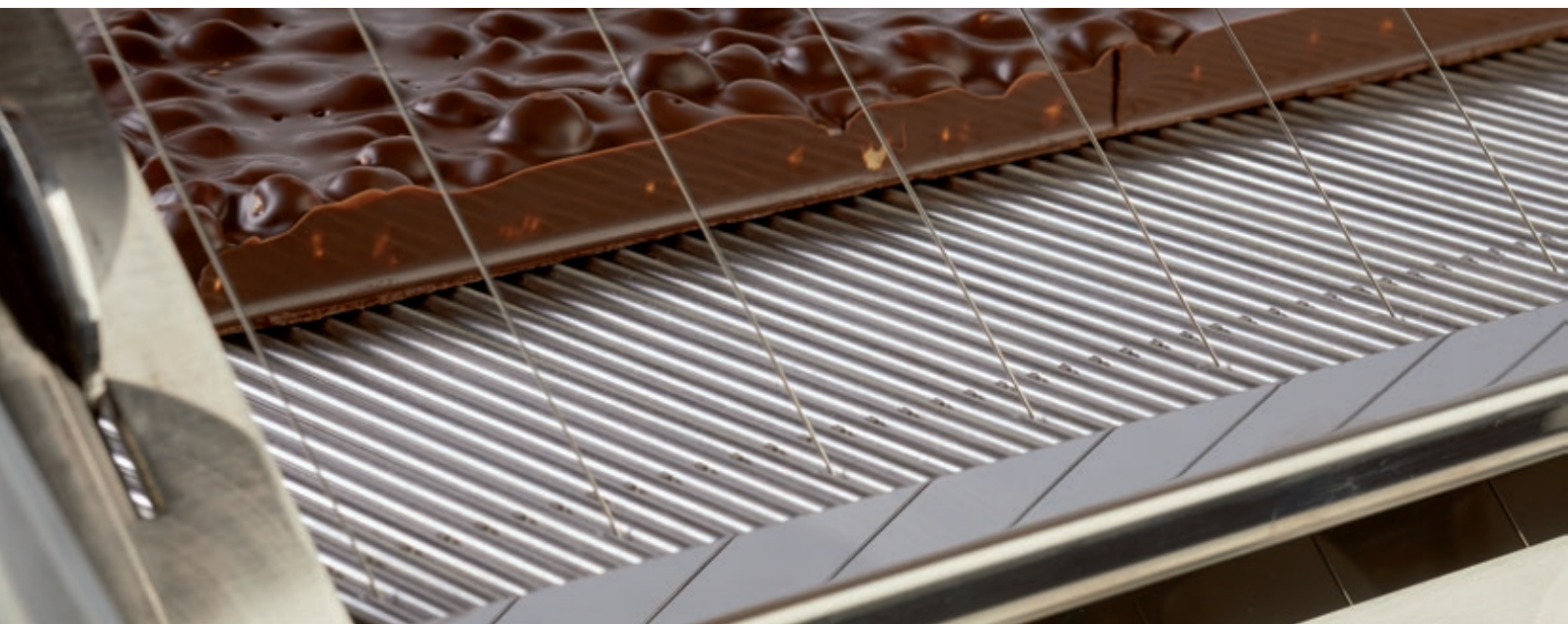

Quattro decenni di innovazione e di esperienza nel **mercato dell'arte bianca, della pasticceria e gelateria professionale e dell'HO.RE.CA.** Da 10 anni anche nel settore casalingo con gli oggetti e le soluzioni del brand PAVONIDEA, testati ed usati da tempo nel mercato professionale dai migliori chef e pasticceri del mondo. Non solo. Una divisione dedicata alla progettazione e realizzazione di una gamma completa di **contenitori in polietilene e polipropilene per l'industria alimentare** e per altri segmenti quali il chimico/farmaceutico, la logistica integrata e l'automotive. Questi sono i numeri PAVONI ITALIA, che fonda la propria costante crescita su **tre principali linee strategiche: la valorizzazione delle risorse umane, l'innovazione e l'internazionalizzazione** nella creazione di una gamma ampia e completa di prodotti

progettati sulle esigenze del cliente, belli e ben fatti con un ottimale rapporto qualità-prezzo.

L'importante reputazione che l'azienda vanta sul mercato per correttezza e trasparenza nella gestione del business è anche accreditata dalla **certificazione ISO 9001:2015** conseguita tra le prime aziende nel settore di appartenenza. Lo staff di designer e creativi opera ogni giorno per dare vita a nuovi prodotti, mentre grazie al reparto Engineering vi è anche la possibilità di creare prodotti "customizzati" per i clienti più esigenti. La combinazione di elevati standard qualitativi in tutte le fasi, dalla progettazione alla commercializzazione, consente la soddisfazione degli ordini acquisiti rispettando i livelli di qualità e i tempi richiesti anche dai mercati più competitivi.

40 anni
di esperienza



40 years
of experience

Oltre 6.000 articoli
di gamma



A range of more
than 6,000 articles

20.500 mq
di struttura



A 20,500 sqm
facility

Oltre 12.000 clienti
in tutto il mondo



More than 12,000
customers worldwide

70% affari
realizzati all'estero



70% of our
business is foreign

Four decades of innovation and experience in the **market of professional baking, confectionery, gelato-making and HO.RE.CA.** 10 years ago we also expanded to PAVONIDEA brand houseware and objects and solutions, with long-term testing and use in the professional market by the best chefs and bakers in the world. And it doesn't stop there. A division dedicated to designing and building a complete range of **polyethylene and polypropylene containers for the food industry** and for other segments such as chemical/pharmaceutical, integrated logistics and automotive. These are the numbers of PAVONI ITALIA, which founds its constant growth on **three main strategic lines: valuing its human resources, innovation and internationalisation** in the creation of a broad and complete range of products designed for customer

needs, products that are appealing and well-made, offering excellent value for money.

The company enjoys an excellent reputation on the market for its correctness and transparency in managing its business and is also accredited with **ISO 9001:2015 certification** obtained by the top businesses in the industry. Our staff of designers and creative talent work every day to realise new products, while, thanks to the Engineering department, we also offer the possibility of creating "customised" products for more demanding customers. The combination of high quality standards in every phase, from design to sales, makes it possible to fulfil orders while maintaining the requested quality levels and time-frames, even by the most competitive markets.

LE PAVONI®

Innovazione e qualità certificata

La linea LE PAVONI rappresenta quanto di meglio si possa trovare sul mercato in relazione alle piccole macchine per la pasticceria e la ristorazione in genere. LE PAVONI si arricchiscono sempre di nuovi ritrovati tecnologici per offrire un prodotto qualitativamente superiore, di grande efficienza e durata. Si tratta di macchine di pratico e facile utilizzo, studiate negli ingombri e nel design in collaborazione con gli operatori nel settore per risolvere le più ampie e diversificate esigenze nel loro lavoro. Macchine sulle quali investire per chiunque voglia migliorare la propria attività. Le macchine PAVONI ITALIA risultano progettate e realizzate nel rispetto delle normative:

- EN 60204-1 (sicurezza delle macchine - sicurezza elettrica)
 - EN 12852 (sicurezza e igiene delle macchine per l'industria alimentare)
- La dichiarazione di conformità, fornita in allegato alla macchina, attesta che la marcatura CE è stata applicata con riferimento a:
- Direttiva 2004/108/CE del 15/12/2004
 - Direttiva 2006/95/CE del 12/12/2006
 - Direttiva 2006/42/CE del Parlamento Europeo e del Consiglio del 17-05-2006
 - Reg.CE 1935/2004 idoneità dei materiali al contatto diretto con alimenti
 - Reg.CE 2023/2006 buone pratiche di fabbricazione (GMP)

Le macchine sono conformi a sistema di certificazione GOST R.

Ogni singola macchina è sottoposta a rigorosi collaudi in ottemperanza agli standard qualitativi interni di fabbricazione, ispirati alla norma UNI EN ISO 9001. Se non diversamente indicato, ogni macchina è garantita 1 anno.

Innovazione e qualità certificata

The LE PAVONI range comprises the best possible selection of small machines for bakeries and caterers in general. The LE PAVONI range is constantly being updated with the latest technology to offer products of superior quality, efficiency and durability. LE PAVONI machines are practical and easy to use, and have been designed in close collaboration with professional caterers to satisfy the largest possible number of requirements. These machines are well worth investing in for anybody intent on improving their business. All machines made by PAVONI ITALIA are designed and made in conformity to the following standards:

- EN 60204-1 (Safety of machinery – Electrical equipment of machines)
- EN 12852 (Food processing machinery - Food processors and blenders - Safety and hygiene requirements)

A declaration of conformity accompanies each machine and certifies that the CE mark has been applied with reference to:

- Directive 2004/108/EC of the 15/12/2004
- Directive 2006/95/EC of the 12/12/2006
- Directive 2006/42/EC of the European Parliament and Council dated 17/05/2006

- EC Regulation 1935/2004 on materials and articles intended to come into contact with food

- EC Regulation 2023/2006 on good manufacturing practice (GMP) for materials and articles intended to come into contact with food

All our machines are certified to conform to GOST R standards.

Each individual machine is subjected to rigorous testing according to internal quality standards based on UNI EN ISO 9001. Unless stated otherwise, all our machines are covered by a one year warranty.



Segui il nostro canale YouTube
Follow our YouTube channel



PAVONITALIASPA



INDICE / INDEX

Taglierine / Cutting machines	pag. 7
Macchine per tartellette / Tartlet machine	pag. 13
Dosatori / Dosing machines	pag. 31
Erogatori / Dispensers	pag. 37
Temperatrici e glassatrici / Tempering and glazing machines	pag. 45
Planetarie ed impastatrici / Planetary mixers	pag. 49
Frantumatori e macinapane / Cutter and crushers bread	pag. 52
Altre macchine / Others machines	pag. 56



LE PAVONI®

TAGLIERINE
CUTTING MACHINES

cod: LIRA/E



GUARDA IL VIDEO
WATCH THE VIDEO!



Lo strumento ideale per pralineria al taglio,
masse dure e prodotti congelati.
*The ideal tool for cutting pralines,
hard foods and frozen products.*

- Taglierina elettrica semiautomatica ideata per il taglio di ogni massa dura e congelata (anche contenente mandorle, nocciole e frutta secca in genere). Perfetta per la produzione al taglio di cremini, nocciolati, torroni morbidi, ganaches, piccola pasticceria (mousses, semifreddi, bavaresi), gelatine, biscotteria, marzapane.
- Taglia prodotti congelati fino a -15°C.
- Tagli veloci e perfetti con notevole risparmio di tempo evitando scarti di prodotto.
- Permette il taglio di prodotti di altezza fino a 6 cm.
- Il piano di taglio, dalla velocità di avanzamento regolabile, è interamente realizzato in acciaio inox AISI 304 ed è facilmente smontabile per un'immediata pulizia anche in lavastoviglie.
- *Semi-automatic, electric cutting machine designed to cut any hard or frozen foods (even those containing almonds, hazelnuts and other dried fruits). Perfect for cutting cremini, hazelnut chocolates, soft nougat, ganache, small confectionary items (mousses, semifreddi, bavaroises), jellies, biscuits and marzipan.*
- *Cuts frozen products up to -15°C.*
- *Rapid, perfect cutting with considerable time savings and no product waste.*
- *Cuts products with thicknesses of up to 6 cm.*
- *The cutting base, with adjustable feed speed, is made entirely of AISI 304 stainless steel and can be easily removed for instant cleaning, even in a dishwasher.*

40 kg

180 Watt

220/240 volt AC
50/60 Hz
A richiesta / On demand
110 volt
50/60 Hz

Garanzia 2 anni
2 years guarantee



Struttura acciaio inox / *Stainless steel structure*
Dim. piano di taglio / *Size cutting framework:*
cm 40 x 40 x 6 H

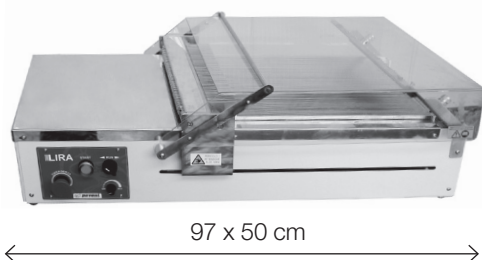

ACCESSORI / ACCESSORIES: LIRA Automatica

VASSOIO/TRAY + SPATOLA/SPATULA
(inclusi / included)



TELAI DI
TAGLIO
CUTTING
FRAMES



cod:	Interasse fili Wire wheelbases	cod:	Interasse fili Wire wheelbases
LT05H6	0,5 cm	LT35H6	3,5 cm
LT10H6	1 cm	LT40H6	4 cm
LT15H6	1,5 cm	LT45H6	4,5 cm
LT20H6	2 cm	LT50H6	5 cm
LT25H6	2,5 cm	LT60H6	6 cm
LT30H6	3 cm		

Altre misure di telaio a richiesta (multipli di 5 mm)
Other frame sizes on request (5 multiple mm)

cod: LIRA/M



GUARDA IL VIDEO
WATCH THE VIDEO!

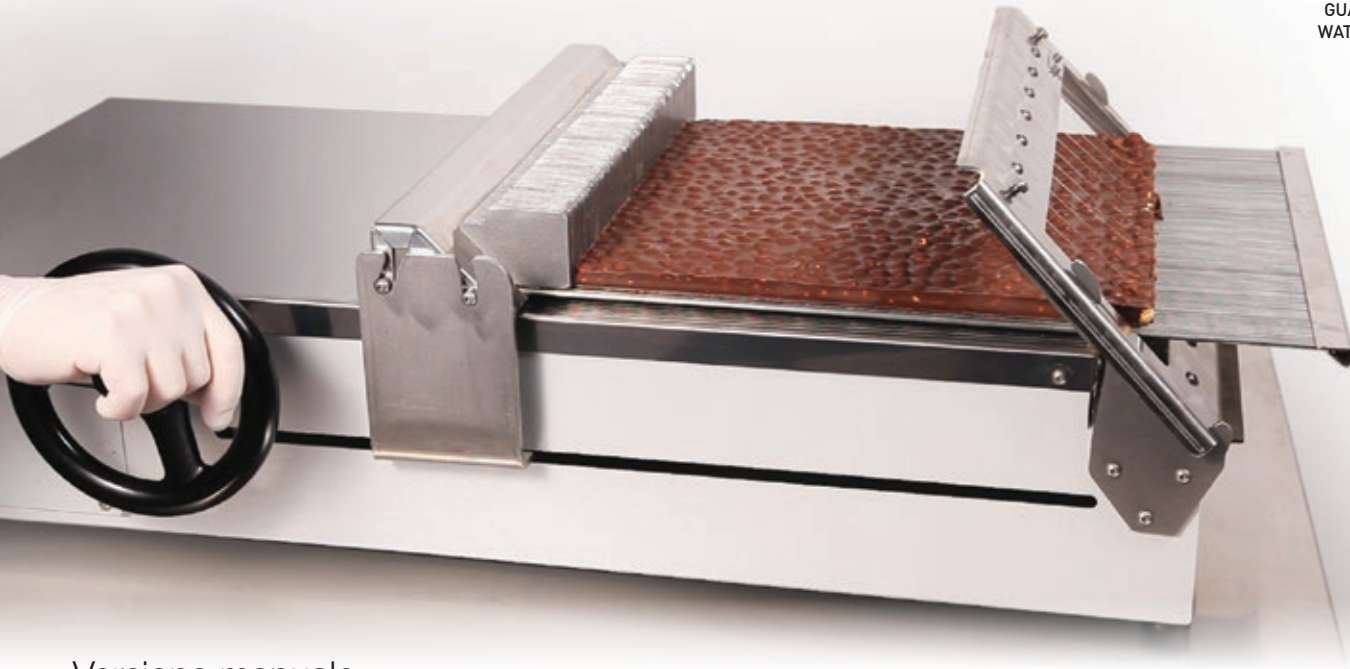

Versione manuale.
Manual version.

/Automatic e/ and LIRA Manuale/Manual

CARRELLO OPZIONALE IN ACCIAIO
INOX AISI 304
*AISI 304 OPTIONAL STAINLESS STEEL
TROLLEY*

cod: CARRELLOLIRA

 36 kg



100 x 53 cm

80 cm

 32 kg

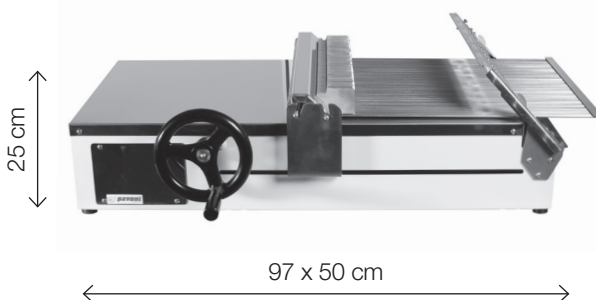

25 cm

97 x 50 cm

- Taglierina manuale ideata per il taglio di ogni massa dura (anche contenente mandorle, nocciole e frutta secca in genere). Perfetta per la produzione al taglio di cremini, nocciolati, torroni morbidi, ganaches, piccola pasticceria (mousses, semifreddi, bavaresi), gelatine, biscotteria, marzapane.
- È composta da una struttura in acciaio verniciato, mentre tutte le componenti a contatto con il prodotto sono realizzate in acciaio AISI 304 nel rispetto delle norme alimentari vigenti.
- L'avanzamento del piano di taglio si ottiene manualmente mediante una manovella che permette all'operatore di controllare la velocità in fase di taglio.
- Il piano è facilmente smontabile per un'immediata pulizia, anche in lavastoviglie.
- *Manual cutting machine for cutting any hard foods (even those containing almonds, hazelnuts and other dried fruit). Perfect for cutting cremini, hazelnut chocolates, soft nougat, ganache, small confectionary items (mousses, semifreddi, bavaroises), jellies, biscuits and marzipan.*
- *The main structure is made of a painted steel; all components that come into contact with the product are made of AISI 304 stainless steel in compliance with applicable food standards.*
- *The cutting base is advanced manually using a hand wheel that allows the operator to control its speed during the cutting stage.*
- *The base can be easily removed for instant cleaning, even in a dishwasher.*

CHITARRA Singola / Single

cod: CHITARRA

INCLUSI: 3 TELAI
INCLUDED:
3 CUTTING FRAMES
 Cod. TCH22.5 - TCH30
 TCH37.5



Lo strumento ideale per il taglio di ganache e masse morbide.

The ideal tool for cutting ganache and soft foods.

- Base di taglio in alluminio anodizzato.
- Telai in materiale di alta qualità.
- Struttura in acciaio inox AISI 304.

- Cutting base made of anodized aluminium.
- Frames made of high quality material.
- Body made of AISI 304 stainless steel.



KG 28 kg

36 x 36 cm
 Dim. utili piano di taglio
 Cutting dimensions

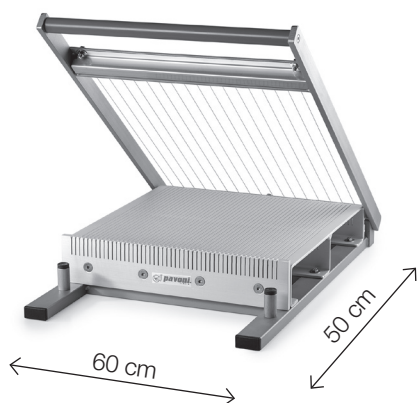

ACCESSORI / ACCESSORIES: CHITARRA Singola

TELAI
 CUTTING
 FRAMES

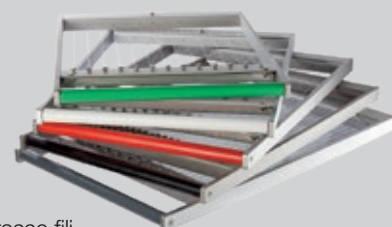

cod:

Interasse fili
 Wire wheelbases

TCH7.5 cm 0,75

TCH15 cm 1,5

TCH22.5 cm 2,25

TCH30 cm 3

TCH37.5 cm 3,75

Altre misure di telaio a richiesta
Other frame sizes on request

QUADRI INOX GANACHE
 STAINLESS STEEL FRAMES

Dim. interne / Inside dim. cm 36 x 36

cod: Altezza
 Height

QG03 cm 0,3 H

QG05 cm 0,5 H

QG10 cm 1 H

QG15 cm 1,5 H

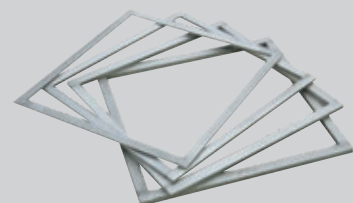

CHITARRA Doppio Taglio / Double

cod: BCD/I

TELAI NON INCLUSI:
CUTTING FRAMES
NOT INCLUDED



La taglierina doppia di facile utilizzo.
Easy-to-use double arm cutter.

la/Single e/and Doppio taglio/Two Way

VASSOIO/TRAY + SPATOLA/SPATULA
(inclusi / included)



CARRELLO IN ACCIAIO INOX
STAINLESS STEEL TROLLEY

cod: CCH

 38 kg



- Permette di tagliare rapidamente il prodotto in un unico passaggio.
- Base di taglio in alluminio anodizzato.
- Struttura in acciaio inox AISI 304.
- Telai in materiale di alta qualità.
- È completamente smontabile per agevolare le operazioni di pulizia e manutenzione.

- Allow rapid cutting of the product in a single step.
- Cutting base made of anodized aluminium.
- Body made of AISI 304 stainless steel.
- Frames made of high quality material.
- Can be completely dismantled for easy cleaning and maintenance work.

 29 kg

 36 x 36 cm
Dim. utili piano
di taglio
Cutting
dimensions

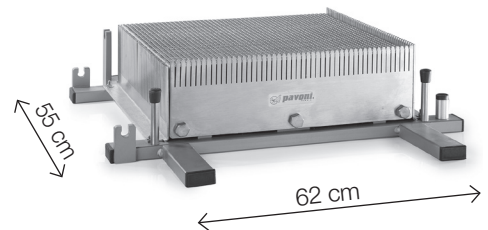



LE PAVONI®

MACCHINE PER TARTELLETTE
TARTLET MACHINE

cod: COOKMATICPAV



GUARDA IL VIDEO
WATCH THE VIDEO!



Basi per tartellette dolci o salate. *Sweet or savoury tartlet shells.*

- Macchina ideata per la produzione di basi, per tartellette o pastafrolla dolce e salata, di varie forme e misure grazie alle piastre intercambiabili. Tramite l'accoppiamento delle due piastre otterrete tartellette perfette per dimensione e cottura.
- Semplice all'uso grazie all'impostazione della temperatura e del tempo per la cottura del vostro impasto.
- Macchina ideale per pasticceria e HORECA.
- *Machine designed for the production of shells for tartlets or sweet or savoury shortcrust pastry of various shapes and sizes, thanks to interchangeable plates. The combination of two plates ensures that the tartlets are perfectly baked and formed.*
- *Cooking temperature and time can be set, making it very simple to use.*
- *Machine ideal for pastry making and the hotel, restaurant and catering industry.*



- 22 kg
- 3200 Watt
- 220/240 volt
A richiesta / On demand
110/380 volt
- Garanzia 2 anni**
2 years guarantee

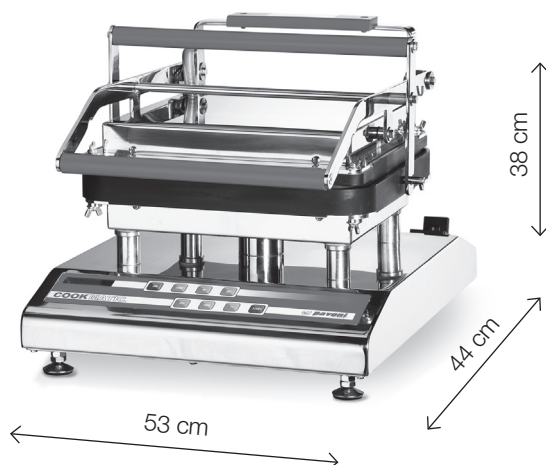

- Facile da pulire.
- Adatta alla produzione in continuo per diverse ore.
- *Easy to clean.*
- *Suitable for continuous production over several hours.*

COOKMATIC SPECIAL

cod: COOKMATIC SPECIAL



Tartellette da record, alte fino a 45 mm!
Record-breaking tartlets, with thicknesses of up to 45 mm!

- Grazie al sistema di scorrimento regolabile in altezza brevettato PAVONI, consente di creare tartellette fino a 45 mm di altezza!
- Ideata per la produzione di basi, per tartellette o pastafrolla dolce e salata, di varie forme e misure grazie alle piastre intercambiabili. Tramite l'accoppiamento delle due piastre otterrete tartellette perfette per dimensione e cottura.
- Semplice all'uso grazie all'impostazione della temperatura e del tempo per la cottura del vostro impasto.
- Macchina ideale per pasticceria e HORECA.
- *Features a height-adjustable sliding system patented by PAVONI that allows tartlets to be created with thicknesses of up to 45 mm!*
- *Designed for the production of shells for tartlets or sweet and savoury shortcrust pastry, of various shapes and sizes, thanks to interchangeable plates. The combination of two plates ensures that the tartlets are perfectly baked and formed.*
- *Cooking temperature and time can be set, making it very simple to use.*
- *Machine ideal for pastymaking and the hotel, restaurant and catering industry.*



 22 kg

 3200 Watt

 220/240 volt
A richiesta / On demand
110/380 volt

Garanzia 2 anni
2 years guarantee

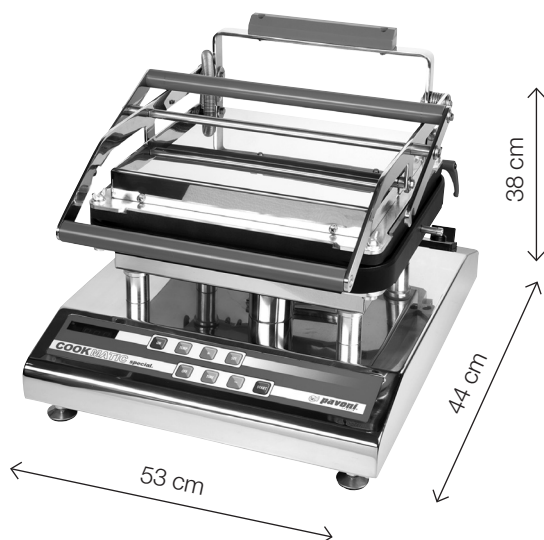

- Facile da pulire.
- Adatta alla produzione in continuo per diverse ore.
- *Easy to clean.*
- *Suitable for continuous production over several hours.*

COOKMATIC Piastre / Plates



GUARDA IL VIDEO
WATCH THE VIDEO!

Cookmatic monta due piastre di cottura: piastra superiore e piastra inferiore, entrambe rivestite di un materiale antiaderente specifico per i prodotti che vanno a contatto con gli alimenti. Sono intercambiabili.

Cookmatic features two hotplates: an upper plate and a lower plate, both coated with a non-stick material for products that come into contact with food. Interchangeable.



Alluminio Anticorodal
lega 6082
*Anticorodal aluminium
6082 alloy*



Rivestimento antiaderente
Non-stick coating



10 kg
variabile a seconda della piastra
variable depending on the plate

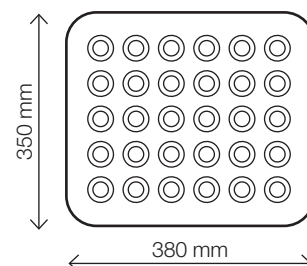

Piastre/plate per/for Cookmatic Special

Dimensioni/dimensions mm

Cod: PIASTRA S05

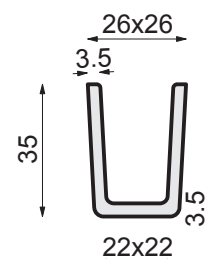
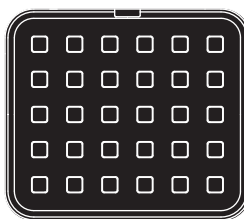

Cod: PIASTRA S03

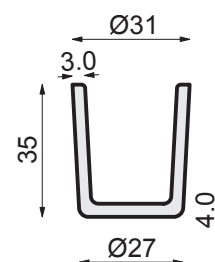
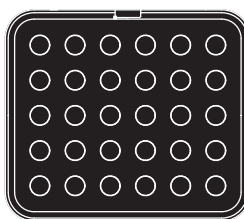

Cod: PIASTRA S04

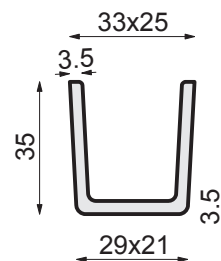
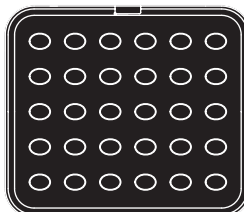

Cod: PIASTRA S01

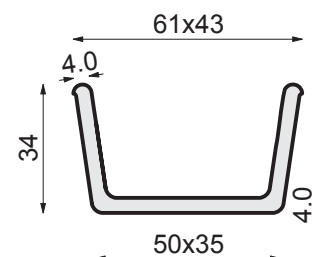
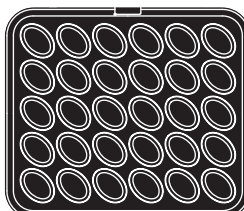



Piastre per/*plate* for Cookmatic (adattabili per / *suitable* for Cookmatic Special)

Eclair

Cod: PIASTRA 39

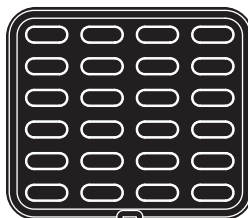

Dimensioni/*dimensions* mm

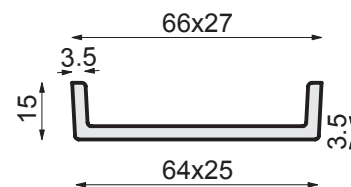

Cod: PIASTRA 38

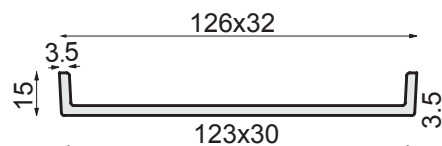
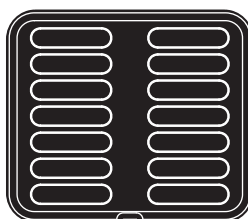

DISEGNO RIDOTTO RISPETTO ALLA SCALA 1:2 / PICTURE REDUCED AS COMPARED TO THE 1:2 SCALE

Tonde / *Round*

Cod: PIASTRA 53

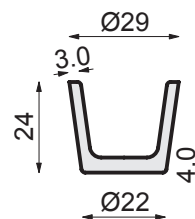
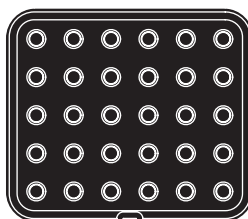

Cod: PIASTRA 9

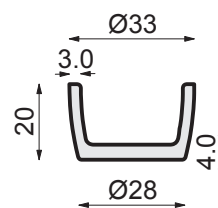
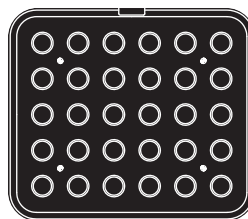

Cod: PIASTRA 15

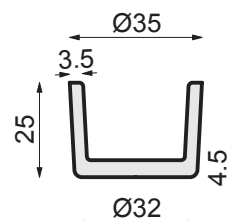
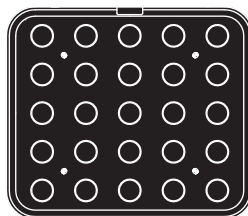

Cod: PIASTRA 44

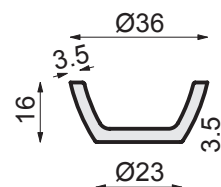
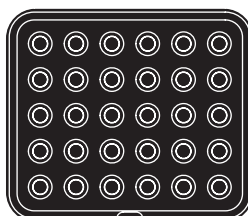

Alcune piastre sono disponibili solo su richiesta / *Some plates are only available upon request*

COOKMATIC Piastre / Plates

Dimensioni/dimensions mm

Cod: PIASTRA 55

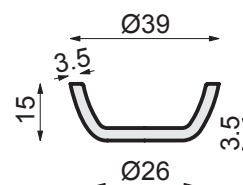
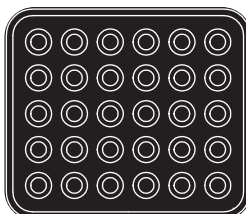

Cod: PIASTRA D

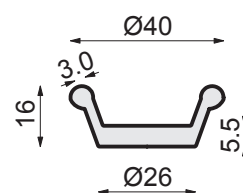
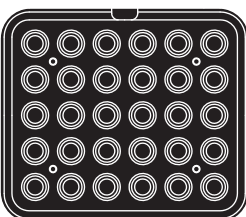

Cod: PIASTRA 16

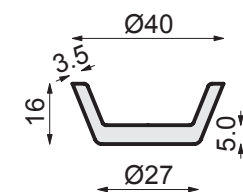
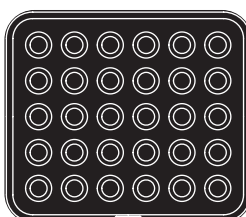

Cod: PIASTRA 2

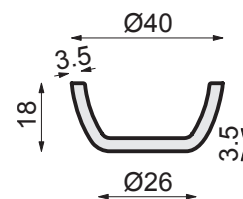
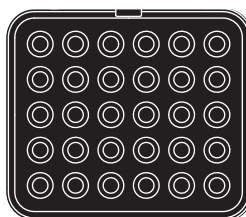

Cod: PIASTRA 43

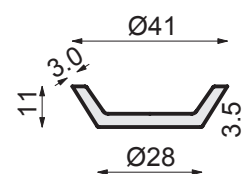
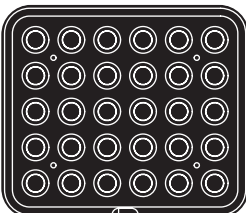

Cod: PIASTRA 52

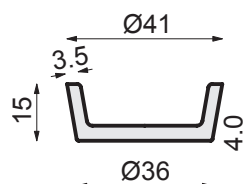
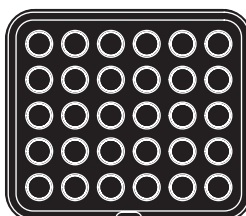



Dimensioni/dimensions mm

Cod: PIASTRA 46

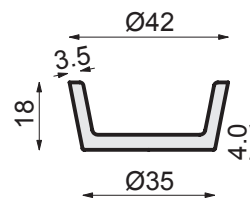
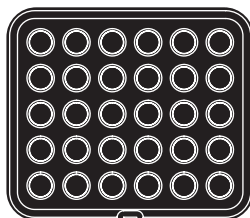

Cod: PIASTRA 42

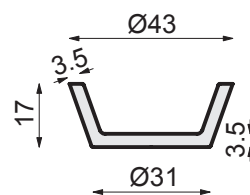
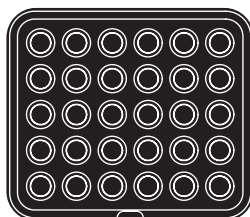

Cod: PIASTRA 0

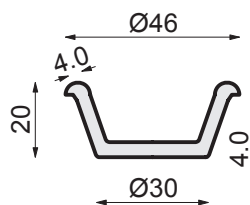
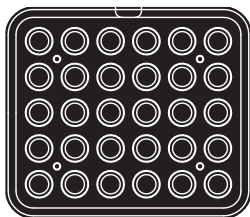

Cod: PIASTRA 37

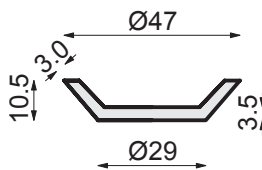
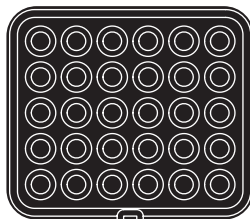

Cod: PIASTRA 26

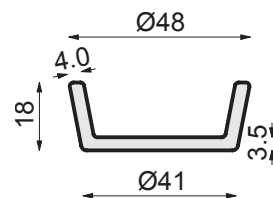
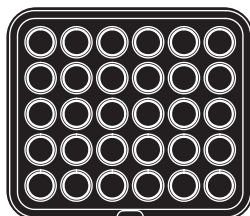

Cod: PIASTRA 12

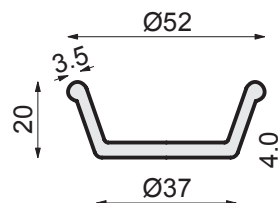
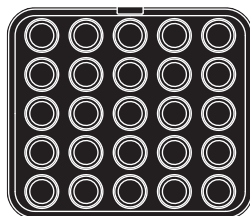

COOKMATIC Piastre / Plates

Cod: PIASTRA 13

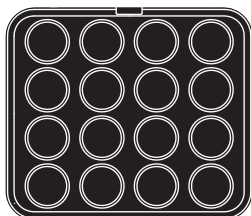

Dimensioni/dimensions mm

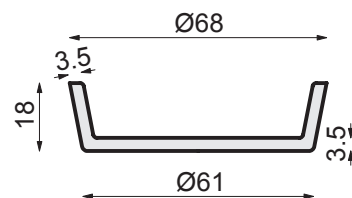

Cod: PIASTRA 41

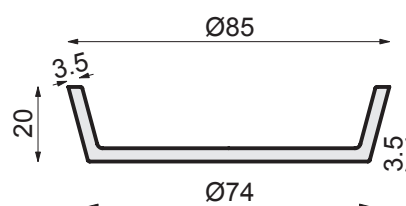
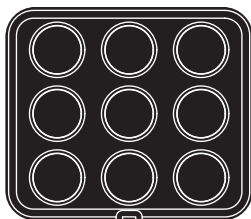

Cod: PIASTRA T

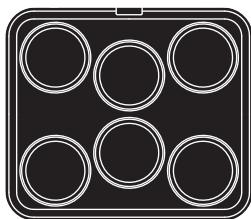

Cod: PIASTRA S

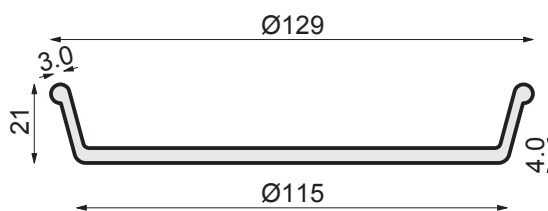
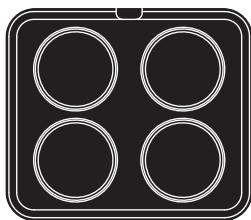

Cod: PIASTRA 57

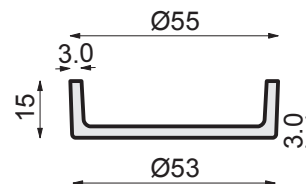
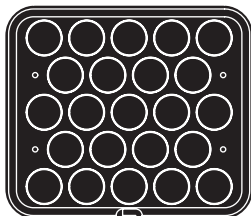

Cod: PIASTRA 21

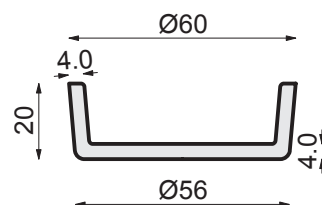
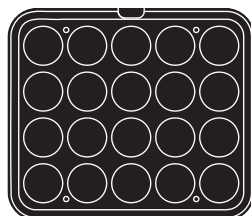



Dimensioni/dimensions mm

Cod: PIASTRA 24

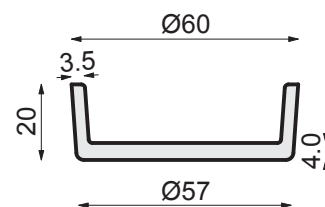
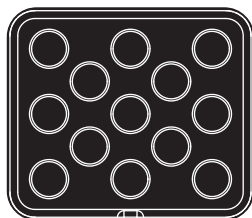

Cod: PIASTRA 56

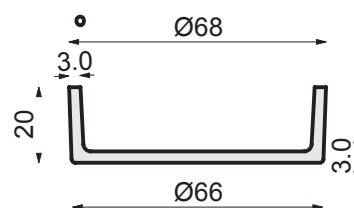
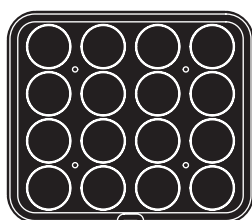

Cod: PIASTRA 29

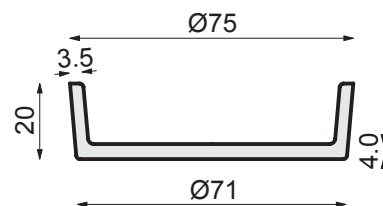
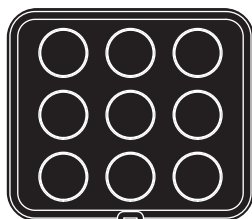

Cod: PIASTRA W

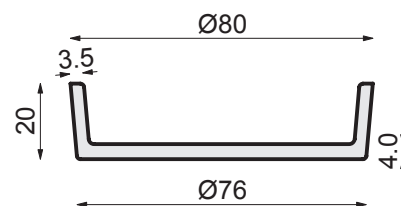
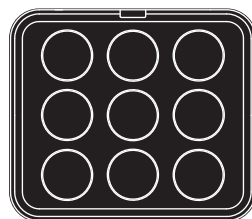

Cod: PIASTRA 45

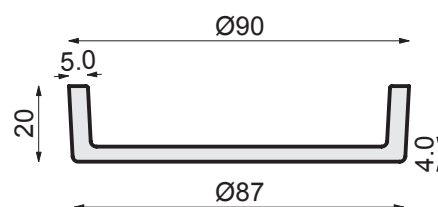
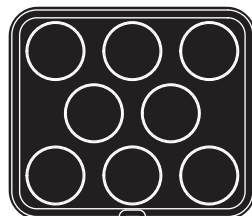

Cod: PIASTRA Z

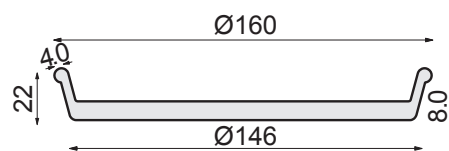
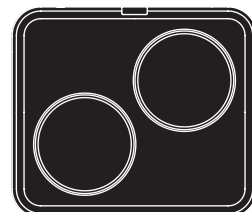

DISEGNO RIDOTTO RISPETTO ALLA SCALA 1:2 / PICTURE REDUCED AS COMPARED TO THE 1:2 SCALE

COOKMATIC Piastre / Plates



Cod: PIASTRA V

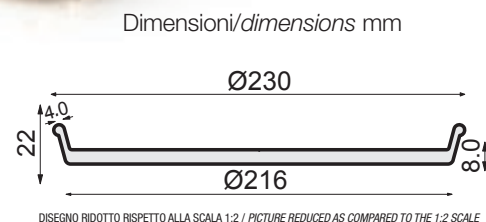
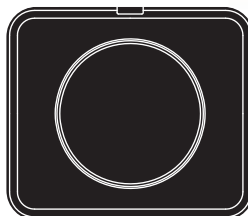

Cod: PIASTRA 11

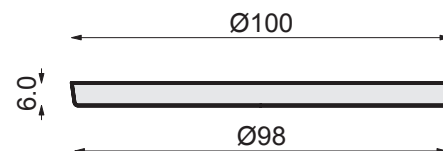
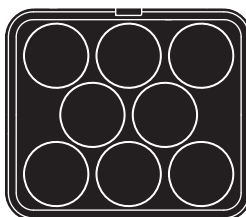

Cod: PIASTRA 62

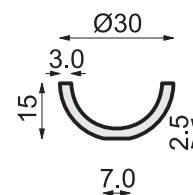
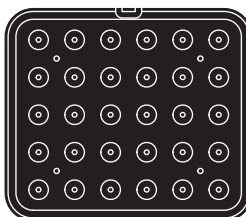

Cod: PIASTRA 61

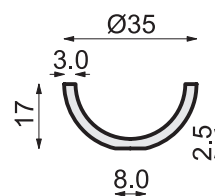
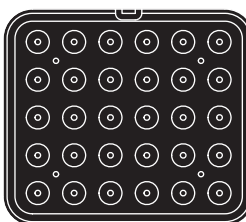

Cod: PIASTRA 58

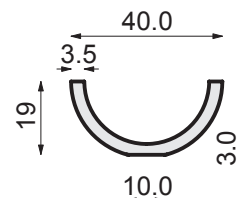
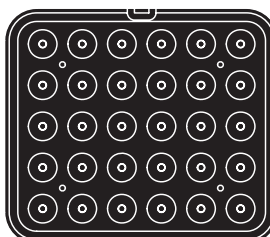

Cod: PIASTRA B

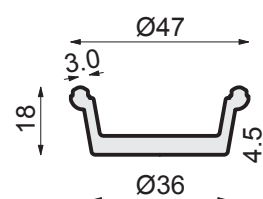
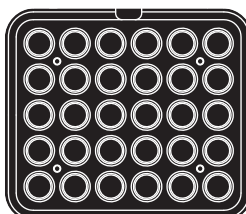



Dimensioni/dimensions mm

Cod: PIASTRA A

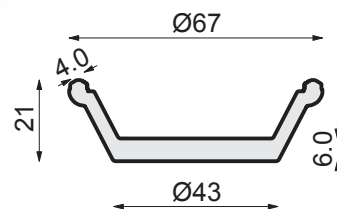
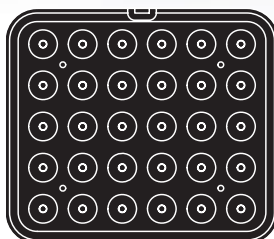

Cod: PIASTRA F

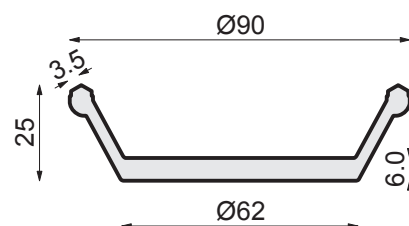
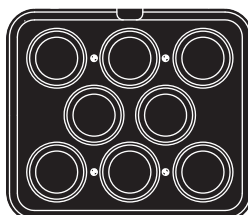

Cod: PIASTRA 6

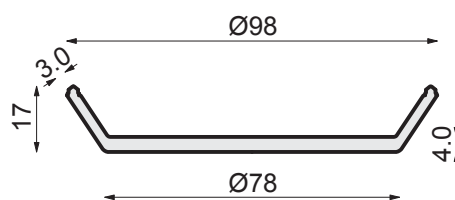
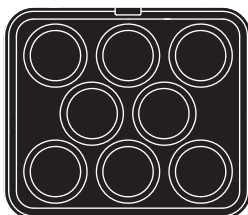

Ovali/Oval

Cod: PIASTRA M

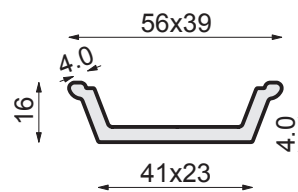
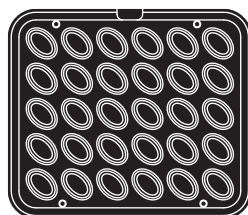

Cod: PIASTRA E

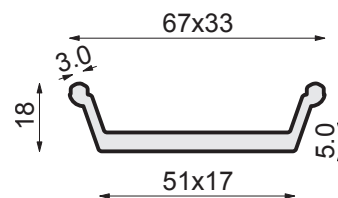

Cod: PIASTRA C

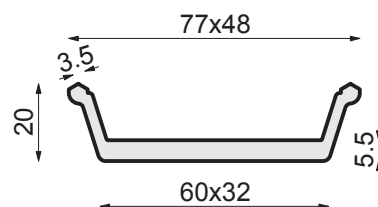
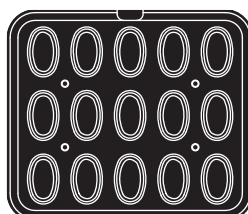

Alcune piastre sono disponibili solo su richiesta / Some plates are only available upon request

Triangolo/*Triangle*

Cod: PIASTRA 22

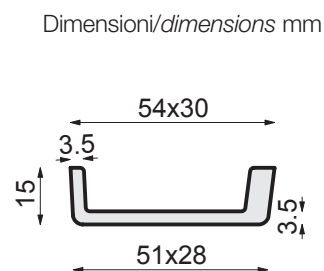

Cod: PIASTRA 19

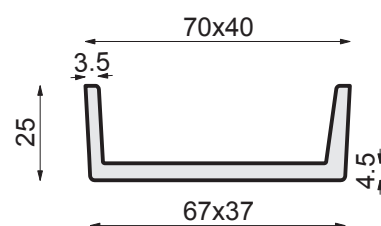

Cod: PIASTRA 18

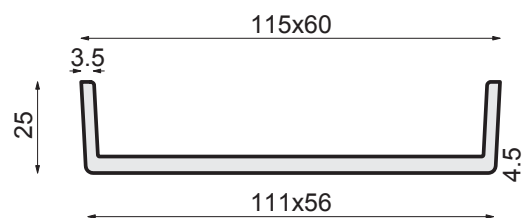
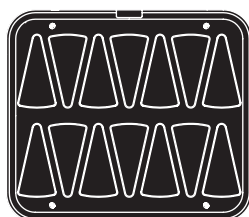

Rettangolo/*Rectangle*

Cod: PIASTRA 17

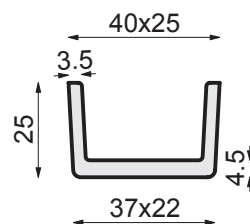

Cod: PIASTRA Q

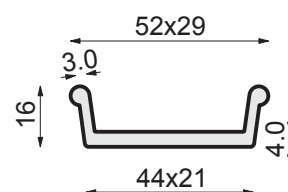
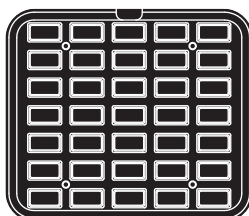

Cod: PIASTRA 40

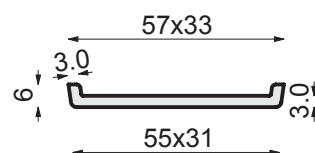
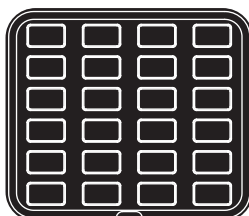

Cod: PIASTRA 4

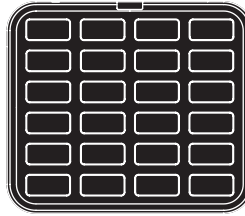

Dimensioni/dimensions mm

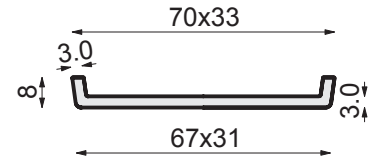

Cod: PIASTRA X

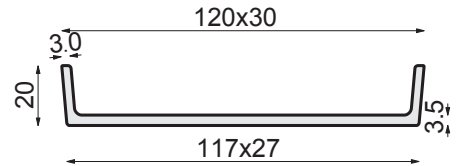
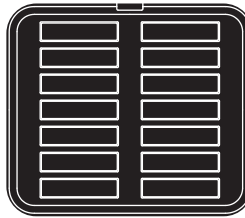

Quadrate/Square

Cod: PIASTRA 34

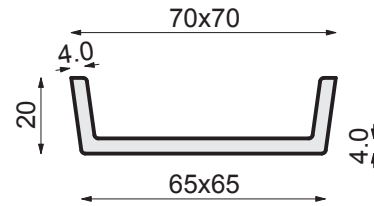
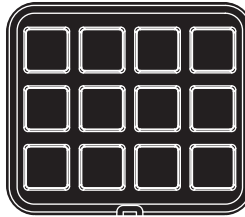

Cod: PIASTRA 10

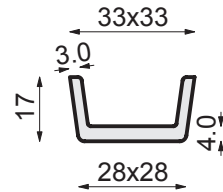
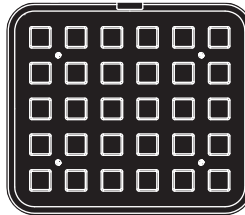

Cod: PIASTRA P

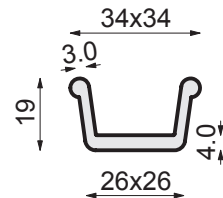
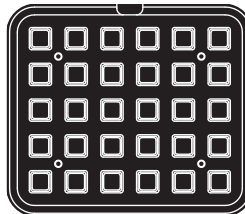

Cod: PIASTRA 3

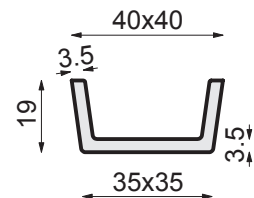

COOKMATIC Piastre / Plates

Dimensioni/dimensions mm

Cod: PIASTRA 27

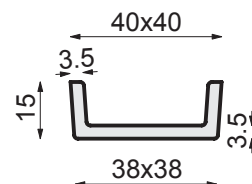
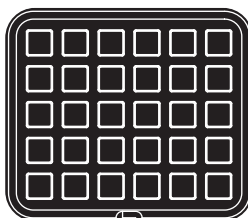

Cod: PIASTRA G

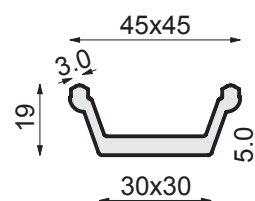
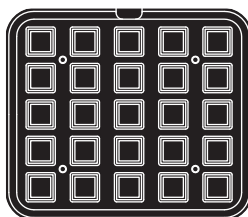

Cod: PIASTRA L

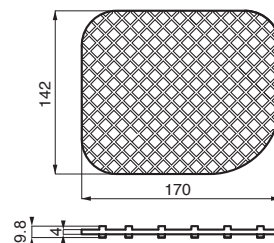
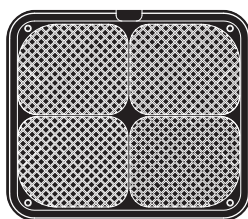

Cod: PIASTRA UM

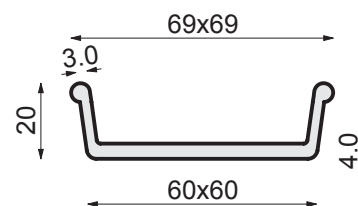
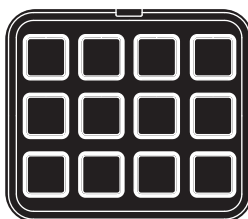

Cod: PIASTRA U

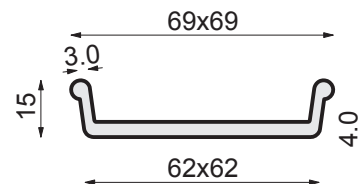
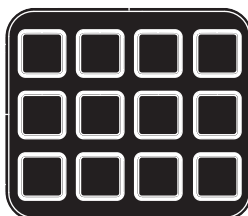

Cod: PIASTRA 35

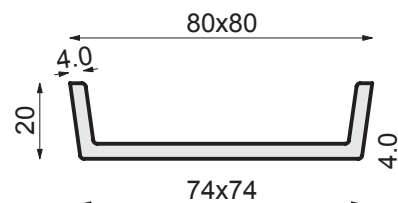
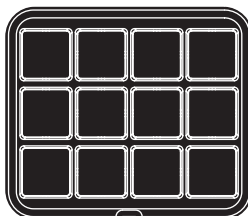

Cod: PIASTRA 47

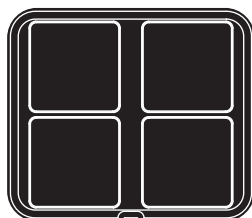
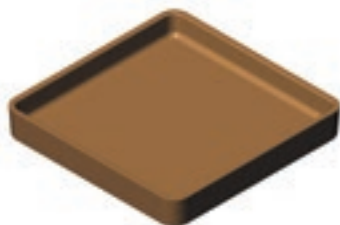

Dimensioni/dimensions mm

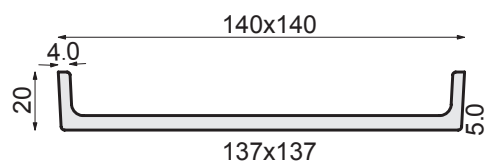

DISEGNO RIDOTTO RISPETTO ALLA SCALA 1:2 / PICTURE REDUCED AS COMPARED TO THE 1:2 SCALE

Cuore/Heart

Cod: PIASTRA 1

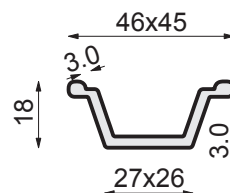
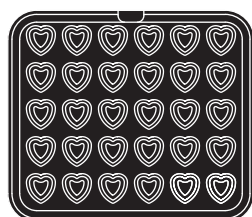

Cod: PIASTRA I

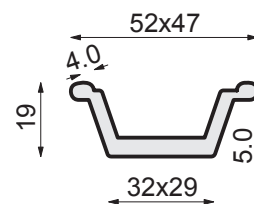

Cod: PIASTRA 59

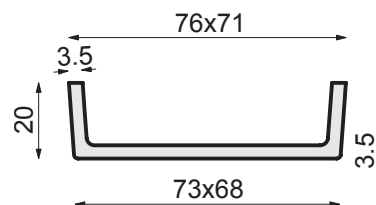
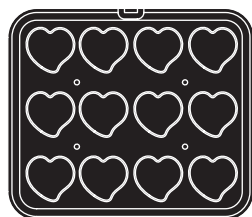

Cod: PIASTRA 60

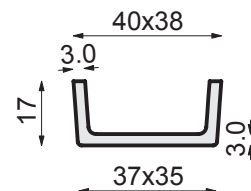

Altre forme / Other forms

Cod: PIASTRA 20



Dimensioni/dimensions mm

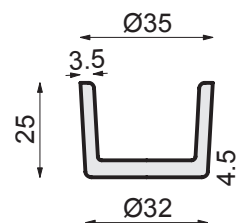

Cod: PIASTRA 5

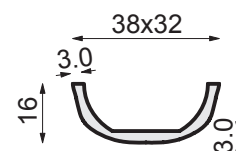

Cod: PIASTRA N

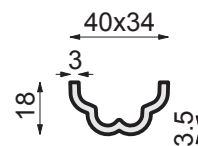
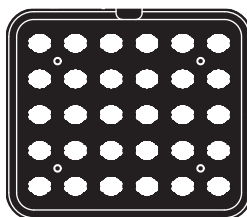

Cod: PIASTRA Y

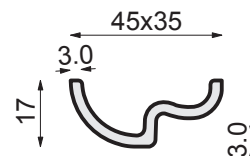
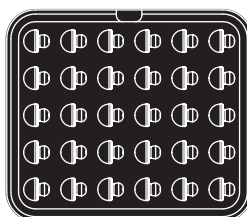

Cod: PIASTRA 14

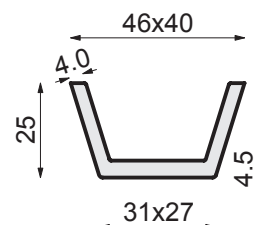

Cod: PIASTRA J

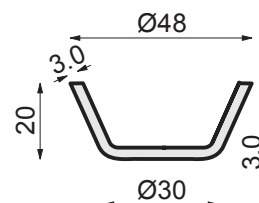
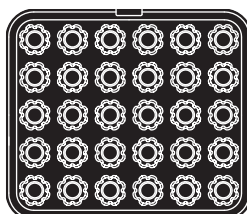

Cod: PIASTRA K

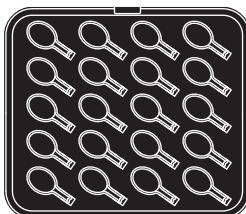

Dimensioni/dimensions mm

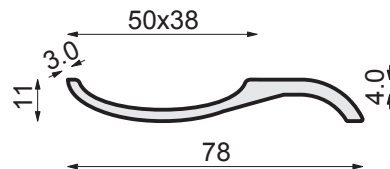

Cod: PIASTRA 00

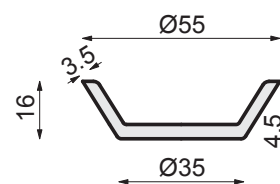
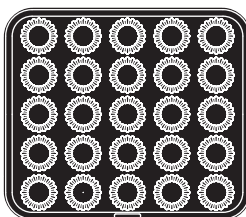

Cod: PIASTRA 8

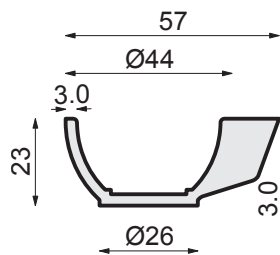
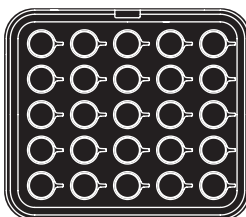

Cod: PIASTRA H

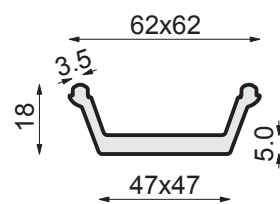

Cod: PIASTRA R

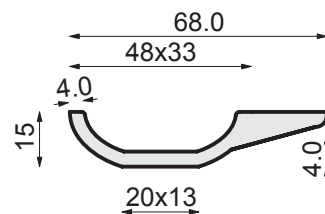
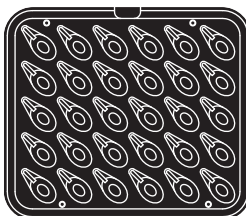

Alcune piastre sono disponibili solo su richiesta
Some plates are only available upon request



LE PAVONI®

DOSATORI
DOSING MACHINES

cod: DOSIPLUSPRO



GUARDA IL VIDEO
WATCH THE VIDEO!



Dosiplus|Pro

La tecnologia più elevata
per il corretto dosaggio.
*Advanced technology
for accurate dosing*

- Progettata per dosare diversi prodotti tra cui creme, miele, confettura, marmellate.
- Nuova interfaccia grafica intuitiva e funzionale.
- Dotata di una scocca in acciaio inox AISI 304, garantisce la massima affidabilità e semplicità di utilizzo.
- 25 velocità di regolazione.
- Disponibilità di tramogge con lobi in gomma per una perfetta erogazione di prodotti delicati e contenenti parti solide (frutta, granelle di nocciola, gocce di cioccolato).
- Funzione reverse con 5 parametri di regolazione (funzione anti-goccia).
- Tutte le opzioni di lavoro Dosiplus Pro permettono, in modalità manuale o automatica, di variare velocemente la quantità di prodotto da dosare, senza sprecaarne nemmeno una goccia.
- Le varie funzioni con salva goccia rendono possibile dosare, iniettare, spalmare e distribuire impasti fluidi, burro, formaggi cremosi, panna e creme, ma anche paste di nocciola, ripieni di frutta, miele, marmellate, salse, burro di arachidi, conserve, budini, yogurt e molto altro.
- Più silenziosa grazie al nuovo motore elettrico. Meno rumore, più potenza!

- *Designed for dosing different products including creams, honey, jams and preserves.*
- *New intuitive and functional graphic interface.*
- *Equipped with a body made of AISI 304 stainless steel, guarantees maximum reliability and simplicity of use.*
- *25 speeds.*
- *Hoppers available with rubber lobes for perfectly dispensing delicate products or products containing solid parts (fruit, chopped hazelnuts, chocolate drops).*
- *Reverse function with 5 adjustment parameters (anti-drip function).*
- *All Dosiplus Pro work options allow the quantity of product dispensed to be changed quickly, in both manual and automatic mode, without wasting a drop.*
- *The various functions with drip catcher make it possible to dose, inject, spread and dispense fluid mixtures, butter, creamy cheese and cream, as well as hazelnut paste, fruit fillings, honey, jams, sauces, peanut butter, preserves, puddings, yoghurt and many other products.*
- *Quieter thanks to a new electric motor. Less noise, more power!*

- 22 kg
- 250 Watt
- 220/240 volt
50/60 Hz
- Garanzia 2 anni
2 years guarantee**



PROGRAMMAZIONE

Tre possibilità di lavoro:

A Lavoro in ciclo AUTOMATICO

M Lavoro in ciclo MANUALE

C Lavoro in ciclo CONTINUO

Tasti opzione

V Regolazione VELOCITÀ

R Regolazione REVERSE



PROGRAMMING

Three work possibilities:

A AUTOMATIC work cycle

M MANUAL work cycle

C CONTINUOUS work cycle

Option keys

V SPEED adjustment

R REVERSE adjustment

ACCESSORI / ACCESSORIES

Tramogge standard con imbuto acciaio INOX AISI 304 per dosare tutti i tipi di prodotto
Standard hopper with INOX AISI 304 stainless steel funnel for dosing all types of product

Cod: 1099044

Tramoggia standard 8 litri con ingranaggi standard per tutti i tipi di lavorazione.
Standard 8-litre hopper with standard gears for all types of processing.



Cod: 1099040

Tramoggia standard 15 litri con ingranaggi standard per tutti i tipi di lavorazione.
Standard 15-litre hopper with standard gears for all types of processing.



- Ingranaggi a lobi in gomma aventi rotazione indipendente e imbuto in acciaio inox AISI 304.
- Con GT8 e GT15 si possono dosare prodotti viscosi contenenti parti solide di 3-4 mm senza romperle (es. mirtili, granelle di nocciola, gocce di cioccolato...) e dosare altresì prodotti delicati che non possono venire compressi in modo eccessivo durante il dosaggio.
- *Gears and rubber lobes with independent rotation and AISI 304 stainless steel funnel.*
- *With GT8 and GT15, viscous products containing solid parts of 3-4 mm can be dosed without breakage (e.g. blueberries, hazelnut granules, chocolate drops...), as well as other delicate products that should not be compressed excessively during the dosing process.*

Cod: GT8

Tramoggia 8 litri con lobi gommati.
8-litre hopper with rubber lobes.



Cod: GT15

Tramoggia 15 litri con lobi gommati.
15-litre hopper with rubber lobes.



DOSIPLUS PRO

ACCESSORI / ACCESSORIES

Cod: FS3271

Fascia riscaldante per tramoggia in silicone rinforzato con regolatore di temperatura. Aggancio fascia con ganci e molle.
Reinforced silicone heating band for hoppers with temperature controller. Band secured with hooks and springs.

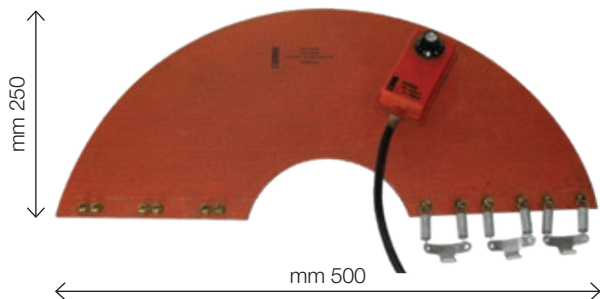

650 Watt

240 volt

0-180°C
 Termostato temperatura regolabile
Adjustable Thermostat temperature

Cod: P-3026

Comando a pedale per lavoro a ciclo manuale.
Pedal control for manual work cycle.



Cod: FS-3000

Tubo flessibile. Utilizzo con ogni beccuccio.
Hose. For use with each spout.
 Lung. / Length 1000 mm



GUARDA IL VIDEO
 WATCH THE VIDEO!



Cod: F-3187 *

Regolatori di flusso antigoccia con valvola.
Non-drip flow regulator with valve.



Cod: F-3147 *

Regolatori di flusso antigoccia con valvola allungato.
Non-drip flow regulator with longer valve.



Cod: DISCO PER TRAMOGGIA 8 LITRI

Utile strumento per schiacciare i composti più consistenti nella tramoggia e facilitare l'erogazione*.
A useful tool for pressing dense compounds in the hopper and to facilitate dispensing.*

* Su richiesta disco tramoggia da 15 litri.
15-litre hopper disk available on request.

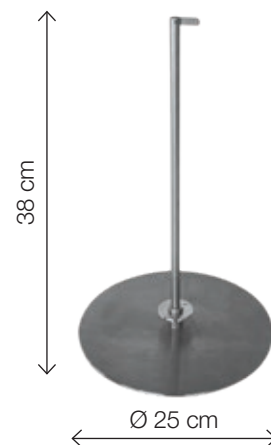

Cod: F3071 *

Il beccuccio a 4 uscite: studiato per riempire composti negli stampi PAVOFLEX.
4-way spout: designed to fill PAVOFLEX moulds.

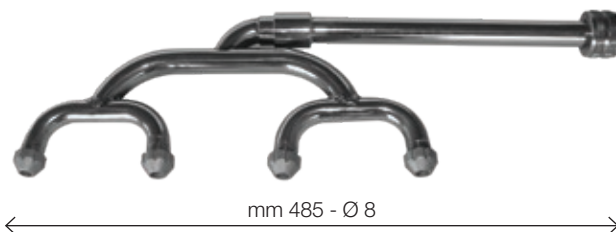

Cod: PB12 / PB24

KIT 12 o 24 bocchette in plastica.
KIT 12 or 24 plastic nozzles.



Cod: F2741

Adattatore bocchette in plastica per FS-3000.
Plastic adaptor nozzles for FS-3000.



Cod: F-3141

Beccuccio adattatore, uscita singola.
Adaptor spout with single outlet.



Bocchette inox per
Stainless steel nozzle for
 F-3141 / FS-3000

Beccucci ricopritori per
Spouts for
 F-3141 / FS-3000



Cod: FS-2739 *
 Ø 14 mm



Cod: FS-2740 *
 5 x 10 mm

Cod: F-2418 *
 Lung. / Length 60 mm



Cod: FS-2760 *
 Ø 12 mm

Cod: F-2861 *
 Lung. / Length 30 mm



Cod: F-2887 *
 Ø 9,5 mm

Uscita singola

Applicabili direttamente sul gruppo tramoggia.

Single outlet

Can be applied directly to the hopper unit.

Ø 6 mm x 3



Cod: F-3101 *

Beccuccio per croissants punta tripla, uscita singola.
Spout for croissants triple point, single outlet.
DIM. 25 mm

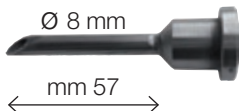

Cod: F-3097

Beccuccio per bigné e cannoncini mignon.
Spout for beignets and mignon cannoncini.

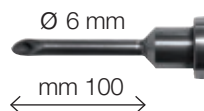

Cod: F-3339

Beccuccio per bigné e cannoncini.
Spout for beignets and cannoncini.

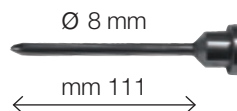

Cod: F-3095

Beccuccio pieno, uscita singola.
Full spout, single outlet.

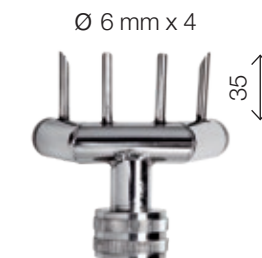

Cod: F-3042 *

Beccuccio per croissants
Si utilizza con i beccucci a uscita singola.
Spout for croissants.
Used with single-outlet nozzles.



Cod: F-3090 *

Beccuccio per marmellate, uscita singola.
Spout for jams, single outlet.

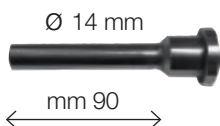

Cod: F-3055 *

Beccuccio per cannoli, uscita singola.
Spout for cannoli, single outlet.



Cod: F-3067 *

Beccuccio pieno.
Full spout.



Cod: F-3091

Beccuccio pieno.
Full spout.



Cod: F-3094

Beccuccio pieno, uscita singola.
Full spout, single outlet.



Cod: F-3212 *

Beccuccio per farciture basi tonde, uscita singola.
Spout for filling round shells, single outlet.
12 Fori / Hole

Uscita doppia

Applicabili con l'adattatore FS-3305

Double output

Can be applied with FS-3305 adaptor



Cod: FS-3305

Adattatore a due uscite per gruppo tramoggia ad un'uscita.
Two-way adaptor for hopper unit with single outlet.



Cod: F-3013

Beccuccio pieno, uscita doppia.
Full spout, double outlet.



Cod: F-3064

Beccuccio per farciture profonde, uscita doppia.
Spout for deep fillings, double outlet.



Cod: F-3076

Beccuccio per bigné e cannoncini mignon, uscita doppia.
Spout for beignets and mignon cannoncini, double outlet.



Cod: F-3011

Beccuccio standard, uscita doppia.
Standard spout, double outlet.



Cod: F-3014

Beccuccio per marmellate, uscita doppia.
Spout for jams, double outlet.

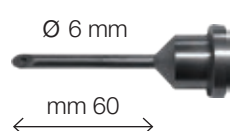

Cod: F-3066

Beccuccio per mignon, uscita doppia.
Spout for mignon, double outlet.

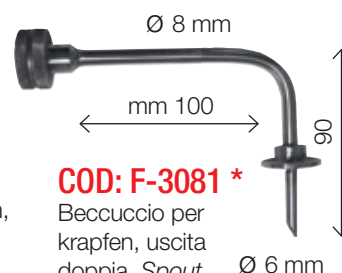

COD: F-3081 *

Beccuccio per krapfen, uscita doppia.
Spout for doughnuts, double outlet.

* A richiesta. Possibilità di avere beccucci su misura. / Customized spouts available on request.

DOSIEMME

cod: DOSIEMME

INCLUSI:

3 iniettori (Ø mm 5/6/7
lunghezza mm 75)
+ valvolina

+ guarnizione + chiave

INCLUDED:

3 injectors (Ø mm 5/6/7
Length mm 75)

+ valve + gasket + wrench

Dosatrice manuale con struttura in alluminio, stantuffo in acciaio inox, imbuto, ugelli e pistone in acciaio inox AISI 304.

Manual dosing machine with aluminium body, stainless steel plunger, funnel, nozzles and AISI 304 stainless steel piston.

 7,2 kg

 Ø 3,1 cm

 7 lt

 da/from 1
a/up to 60 gr

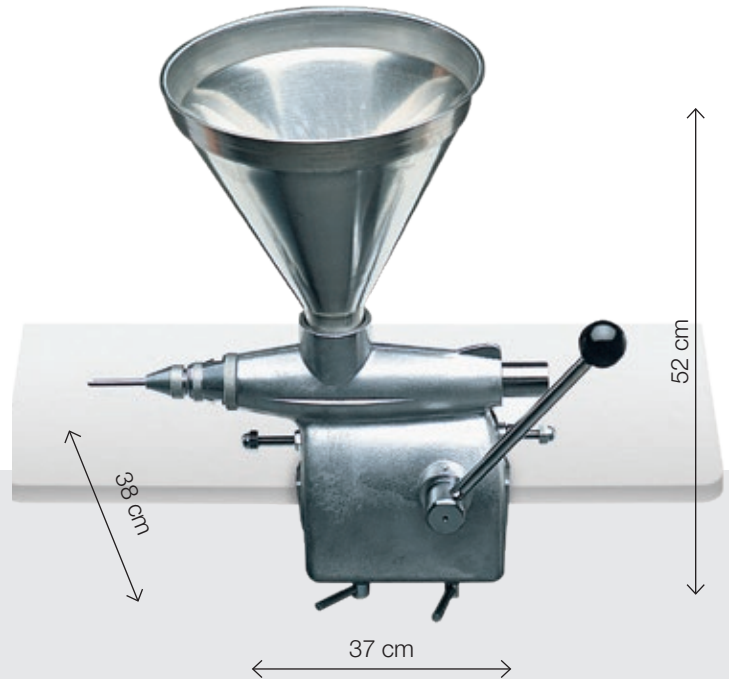

DOSIMINI

cod: DOSIMINI

INCLUSI:

3 iniettori (Ø mm 5/6/7
lunghezza mm 75)
+ valvolina

+ guarnizione + chiave

INCLUDED:

3 injectors (Ø mm 5/6/7
Length mm 75)

+ valve + gasket + wrench

Dosatrice manuale con stantuffo in acciaio inox.

Manual dosing machine with stainless steel plunger.

 2,7 kg

 Ø 2,4 cm

 3 lt

 da/from 1
a/up to 12 gr

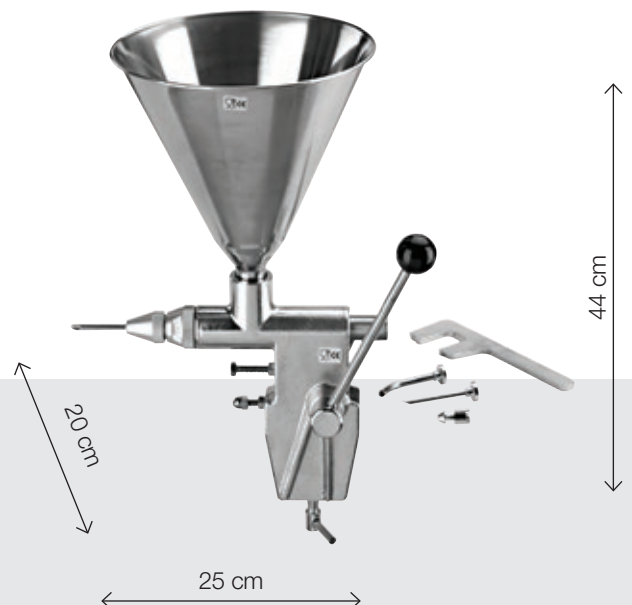

LE PAVONI®

EROGATORI
DISPENSERS

SPRAYCOMPACT

cod: SPRAYCOMPACT

INCLUSI:

Ugelli per cono (Ø mm 40 e 80)
Ugello per crostate e torte di grandi dimensioni
Imbuto + chiave per rabbocco acqua distillata nella caldaia

INCLUDED:

Nozzle for cone (Ø mm 40 and 80)
Nozzle for large-sized tarts and cakes
Funnel and wrench for topping up distilled water in boiler



La più compatta delle macchine per spruzzare la gelatina.
The most compact jelly glaze spraying machine available.

- Consente di ottenere una distribuzione del prodotto realmente uniforme, ottimizzando i tempi e la quantità di prodotto utilizzata.
- Realizzata in acciaio inox.
- Nonostante le sue piccole dimensioni la macchina è dotata di un proprio compressore e di una potente caldaia.
- La temperatura e la pressione sono regolabili mediante le apposite manopole.
- Utilizzabile con gelatina liquida a temperatura ambiente.
- Ensures even glaze distribution, thereby optimizing spraying times and minimizing the quantity of jelly used.
- Made of stainless steel.
- In spite of its small size, it is equipped with its own compressor and a powerful boiler.
- Separate knobs permit adjustment of temperature and pressure.
- Can be used with liquid glaze at room temperature.





 25 kg

 1600 Watt

 230/240 volt
50 Hz

A richiesta / On demand
110 volt
60 Hz

 Capacità di erogazione 350 cc/min
Dispensing capacity

 Pressione di erogazione 3,7 bar
Dispensing pressure

 Temperatura di esercizio fino a/up to 90°C
Working temperature

 Potenza riscaldante 1500 watt
Warm power

Garanzia 2 anni
2 years guarantee



cod: SPRAYDYNAMIC

INCLUSI:

Ugelli per cono (Ø mm 40 e 80)
 Ugello per crostate e torte di grandi dimensioni
 Imbuto + chiave per rabbocco acqua distillata nella caldaia

INCLUDED:

Nozzle for cone (Ø mm 40 and 80)
 Nozzle for large-sized tarts and cakes
 Funnel and wrench for topping up distilled water in boiler



GUARDA IL VIDEO
 WATCH THE VIDEO!

Una piccola macchina dalle grandi prestazioni.
 A small machine with outstanding performance.



Comoda regolazione di pressione della gelatina per lavorare i prodotti con la potenza di spruzzo desiderata.

Easy adjustment of pressure for distributing the product with the desired spraying power.

- Erogatore polivalente dalle dimensioni compatte in grado di fornire prestazioni elevate.
- La pistola erogatrice può essere impiegata per spruzzare gelatine a caldo oppure liquidi freddi quali bagna e liquori.
- Dispone di un proprio compressore e di una potente caldaia ermetica per il riscaldamento del prodotto.
- La caldaia ermetica permette un rapido riscaldamento dell'acqua, accorciando i tempi di attesa e consentendo un notevole risparmio energetico.
- La temperatura è regolabile mediante l'interfaccia elettronica.
- L'impiego di Spray Dynamic consente di ottenere una distribuzione del prodotto uniforme, ottimizzando i tempi e la quantità di gelatina o bagna utilizzata.

- Compact, multi-purpose sprayer with outstanding performance.
- Spray gun can be used to spray hot glaze or cold liquids such as infusions and liqueurs.
- Features a compressor and powerful sealed system boiler for heating the product.
- A sealed system boiler ensures fast heating of the water, reducing waiting times and guaranteeing considerable energy savings.
- Temperature is controlled by means of an electronic interface.
- Spray Dynamic ensures even product distribution, cuts times and reduces the amount of glaze or infusion used.

30 kg	Capacità di erogazione Dispensing capacity	400 cc/min
1700 Watt	Pressione di erogazione Dispensing pressure	4 bar
220/240 volt 50 Hz A richiesta / On demand 110 volt 60 Hz	Temperatura di esercizio regolabile Adjustable working temperature	fino a/up to 90°C
Garanzia 2 anni 2 years guarantee	Potenza riscaldante Warm power	1500 watt

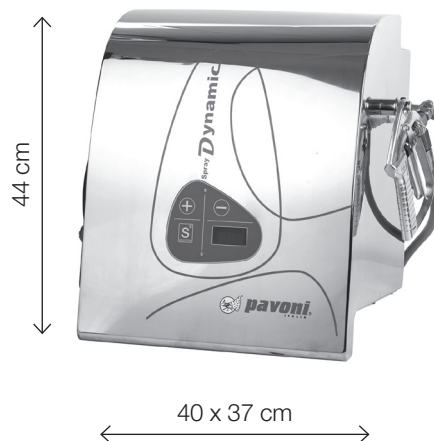

Carrello in acciaio
 inox AISI 304
 (opzionale)
 Stainless steel trolley
 AISI 304 (optional)
Cod: CARSPRAY

12 kg	40x40 cm H 80 cm
-------	---------------------

SPRAY GEL VPM

cod: SPRAYGELVPM

INCLUSI:

Ugelli per cono (Ø mm 40 e 80)
Ugello per crostate e torte di grandi dimensioni
Imbuto + chiave per rabbocco acqua distillata nella caldaia

INCLUDED:

Nozzle for cone (Ø mm 40 and 80)
Nozzle for large-sized tarts and cakes
Funnel and wrench for topping up distilled water in boiler



GUARDA IL VIDEO
WATCH THE VIDEO!



L'erogatrice di gelatina rapida e potente.
The fast, powerful jelly glaze sprayer.

- Caldaia ermetica permette un rapido riscaldamento, accorciando i tempi di attesa e un conseguente risparmio energetico.
 - L'apposito vano posteriore permette di alloggiare il contenitore della gelatina all'interno della macchina.
 - La macchina è dotata di innesto rapido ad aria compressa posto sul frontalino comandi.
 - Il compressore più potente può essere sfruttato con varie attrezzature: aerografo, pistola per cioccolato e tutti quegli utensili che necessitano di aria compressa.
 - La scocca in acciaio inox consente una pulizia facile e rapida.
-
- A sealed system boiler ensures rapid heating, thereby reducing waiting times and providing considerable energy savings.
 - The jelly glaze container is situated in a dedicated rear compartment within the machine.
 - The machine features a push-fit compression fitting on the front panel.
 - This powerful compressor can be used with a range of tools: airbrush, chocolate gun and any other tool requiring compressed air.
 - Stainless steel body for fast, easy cleaning.





 70 kg

 2700 Watt

 220/240 volt
50-60 Hz
A richiesta / On demand
110 volt
60 Hz

Garanzia 2 anni
2 years guarantee

 Capacità di erogazione
Dispensing capacity 450 cc/min

 Pressione di erogazione
Dispensing pressure da/from 2,8 a/up to 5 bar

 Temperatura di esercizio
Working temperature fino a/up to 90°C

 Potenza riscaldante
Warm power 2500 watt



SPRAY GEL TWIN

cod: SPRAYGELTWIN/C

Due macchine in una.
Two machines in one.

Doppio utilizzo a caldo.

La macchina è dotata di due pistole aventi i tubi di aspirazione di colore rosso per l'erogazione di gelatina. Con questa versione due operatori possono lavorare contemporaneamente sulla stessa macchina erogando gelatine di gusti differenti (ad es. fragola e albicocca o fragola e neutra).

Dual use for hot spraying.

This machine is fitted with two guns with red hoses for spraying glaze. It allows two operators to work simultaneously with the same machine using glazes of different flavours (e.g. strawberry and apricot or strawberry and neutral).

cod: SPRAYGELTWIN/F

Utilizzo caldo-freddo.

Il prodotto gelatina è erogato dalla pistola posta sul lato destro della macchina e collegata al tubo di aspirazione di colore rosso; viceversa il prodotto bagna o liquidi è erogato dalla pistola collocata sul lato sinistro con il tubo di aspirazione di colore azzurro.

La presenza della doppia pistola consente dunque di lavorare contemporaneamente a diverse applicazioni nel modo più efficace ed efficiente possibile.

Hot-cold use.

Glaze is sprayed from the gun positioned on the right-hand side of the machine and connected to the red hose; while infusions or liquids are sprayed from the gun on the left-hand side, which is connected to the blue hose.

The presence of two guns, therefore, allows operators to work together using different products in the most efficient and effective way possible.

- Dotata di due circuiti separati che permettono una doppia erogazione.
 - Innesto rapido ad aria compressa estremamente potente.
 - L'aspirazione avviene direttamente dai contenitori (posti nella parte inferiore estraibile per facilitarne la movimentazione e agevolare la pulizia del vano) ed i prodotti vengono inviati agli erogatori, evitando il contatto con l'aria a garanzia della massima igiene.
 - La scocca è interamente costruita in acciaio inox e permette una facile e rapida pulizia.
 - Dotata di una caldaia ermetica che consente un rapido riscaldamento.
- *Equipped with two separate circuits for spraying two different products.*
 - *Extremely powerful push-fit compression fitting.*
 - *The product is drawn directly from the containers (positioned in the lower part, which can be removed for easy handling and cleaning of the compartment) and sent to sprayers without coming into contact with the air, thus guaranteeing maximum hygiene.*
 - *The body is made entirely of stainless steel for fast, easy cleaning.*
 - *Equipped with a sealed system boiler for rapid heating.*

INCLUSI:
Ugelli per cono (Ø mm 40 e 80)
Ugello per crostate e torte di grandi dimensioni
Imbuto + chiave per rabbocco acqua distillata nella caldaia
INCLUDED:
Nozzle for cone (Ø mm 40 and 80)
Nozzle for large-sized tarts and cakes
Funnel and wrench for topping up distilled water in boiler



80 kg

3200 Watt

220/240 volt
50 Hz

A richiesta / On demand
220/240 volt
60 Hz

Garanzia 2 anni
2 years guarantee

Capacità di erogazione
Dispensing capacity 450 cc/min

Pressione di erogazione
Dispensing pressure da/from 2,8 a/up to 5 bar

Temperatura di esercizio regolabile
Adjustable working temperature fino a/up to 90°C

Potenza riscaldante
Warm power 3000 watt



52 x 50 cm
larghezza con 2 pistole 65 cm
width with two pistols 65 cm

cod: CIOCOSPRITZ



GUARDA IL VIDEO
WATCH THE VIDEO!



Vano con apertura. Il cioccolato sciolto temperato viene riposto in un contenitore introdotto nell'apposito vano posteriore riscaldato al fine di mantenere il cioccolato in tempera.
Compartment with opening. The melted tempered chocolate is kept in a container positioned in a special rear compartment, which is heated to maintain the chocolate in a tempered state.



DIM. vano interno /
Internal compartment
mm 150 x 200 x 200 h

Erogatore per cioccolato e surrogato.
Spraying machine for chocolate and substitutes.

- Realizzato per nebulizzare il cioccolato temperato e il surrogato.
- Ciocospritz permette di regolare aria compressa e prodotto separatamente al fine di ottenere un risultato ottimale.
- La temperatura è regolabile fino a 60°C.
- *Designed to spray tempered chocolate and substitutes.*
- *Ciocospritz enables compressed air and product to be controlled separately to ensure perfect results.*
- *The temperature can be adjusted up to 60°C.*



- Cioccolato e surrogato sempre pronto all'uso.
- Temperatura costante.
- Compatto e semplice da usare.
- Molteplici possibilità di impiego.
- Realizzazioni di effetti decorativi particolari: effetto velluto, effetto polvere di cacao, effetto neve, effetto granulato, effetto buccia d'arancia, righe, punti, etc.
- *Chocolate or substitute are always ready for use.*
- *Constant temperature.*
- *Compact and easy to use.*
- *Wide range of applications.*
- *Can be used to create special decorative effects: velvet, cocoa powder, snow, granule, orange peel, stripes, dots, etc.*



Cod: 160100250

Carrello in acciaio inox
AISI 304 (opzionale)
*Stainless steel trolley
AISI 304 (optional)*

	24 kg
	250 Watt
	220/240 volt 50-60 Hz
A richiesta / On demand 110 volt 60 Hz	

Garanzia 2 anni
2 years guarantee



Cod: 160100279



Compressore (opzionale)
Air compressor (optional)

	22 kg
	1 HP 750 Watt
	220/240 volt 50 Hz
	Pressione erogazione 8 bar <i>Dispensing pressure 116 Psi</i>
	6 lt

cod: OVOSPRAY

INCLUSO COMPRESSORE
INCLUDED AIR COMPRESSOR

cod: OVOSPRAYSCOMP

SENZA COMPRESSORE
WITHOUT COMPRESSOR



GUARDA IL VIDEO
WATCH THE VIDEO!



Per spruzzare l'uovo e tanto altro.
For spraying egg and many other products.

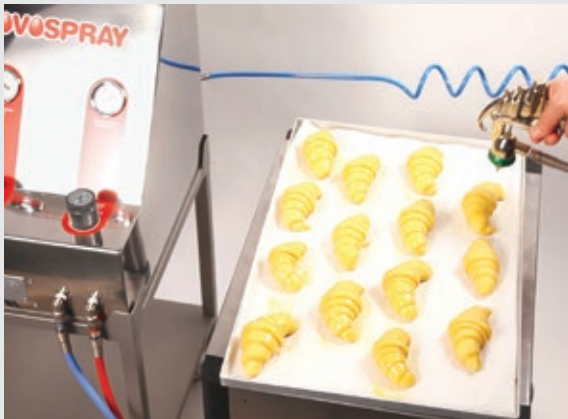

- Realizzato per spruzzare uovo, bagna, olio o staccante stampi e teglie.
- Il prodotto viene aspirato direttamente dal contenitore.
- La pressione dell'aria e del liquido vengono regolati separatamente per ottenere un risultato ottimale.
- La struttura della macchina e del carrello sono realizzate in acciaio inox AISI 304.
- *Designed for spraying egg, infusions, oil or pan- and mould-release agents.*
- *The product is drawn directly from the container.*
- *Air and liquid pressure can be controlled separately to ensure perfect results.*
- *The body and trolley are made of AISI 304 stainless steel.*



KG senza compressore
40 kg
con compressore
60 kg

⏏ 1 hp
750 Watt

⚡ 220/240 volt
50-60 Hz

A richiesta / On demand
110 volt
60 Hz

🕒 Capacità di erogazione
Dispensing capacity 400 cc/min

📏 Pressione di erogazione
Dispensing pressure da/from 0,5 a/up to 4,5 bar

🌐 Pressione di aspirazione
Intake pressure da/from 0,5 a/up to 4,5 bar

Garanzia 2 anni
2 years guarantee



LE PAVONI®

TEMPERATRICI E GLASSATRICI
TEMPERING AND GLAZING MACHINES

cod: MINITEMPER



GUARDA IL VIDEO
WATCH THE VIDEO!



La temperatrice per il cioccolato.
Chocolate tempering machine.

- Programmi di temperaggio personalizzabili.
- Macchina da banco di piccole dimensioni e semplice da utilizzare.
- Temperatrice con un ottimo rapporto qualità/prezzo.
- Mantenimento del cioccolato in tempera per diverse ore.
- Macchina e bacinella realizzate in acciaio inox AISI 304, coperchio trasparente in PET per il mantenimento della temperatura nel totale rispetto delle normative igieniche.
- Bacinelle intercambiabili.

- *Tempering programmes can be customized.*
- *Small, easy to use, table-top machine.*
- *Excellent quality/price ratio.*
- *Chocolate maintained in tempered state for several hours.*
- *Machine and bowl made of AISI 304 stainless steel, transparent lid made of PET to maintain temperature in full compliance with hygiene standards.*
- *Interchangeable bowls*



	20 kg
	300 Watt
	220/240 volt 50 Hz
<i>A richiesta / On demand</i>	220/240 volt 60 Hz Oppure / Or 110 volt 60 Hz
	5 lt - 3 kg

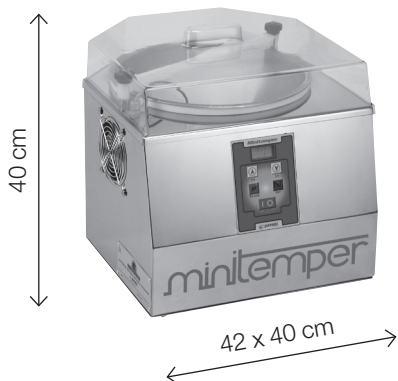

Garanzia 2 anni
2 years guarantee

cod: GLASS-ICE



Per una glassatura perfetta senza sprechi.
For perfect icing without waste.

- Veloce, pratica ed innovativa, la glassatrice vi permetterà di glassare in modo perfettamente uniforme i vostri prodotti, senza il minimo spreco di materia prima.
- *Fast, practical and innovative, this enrobing machine ices your products evenly without wasting any raw material.*

	50 kg
	700 Watt
	220/240 volt 50 Hz
	A richiesta / On demand 110 volt 60 Hz

Garanzia 2 anni
2 years guarantee

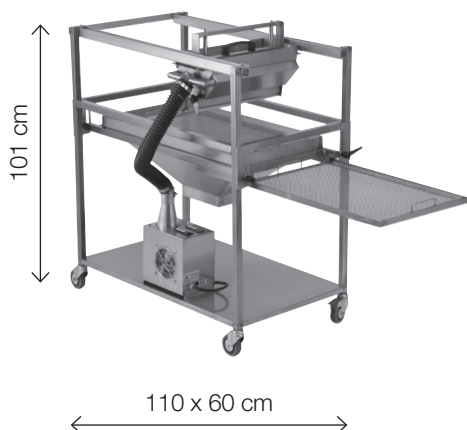

METODO D'UTILIZZO - Use

Recipiente di grandi dimensioni da riempire con cioccolato, zucchero, fondant, etc.
Large basin to be filled with chocolate, sugar, fondant, etc.

Facile da usare: con un semplice gesto della mano glassa 100 paste mignon in 15 secondi.
Easy to use: a simple movement of the hand to glaze 100 mignon pastries in 15 seconds.

La vaschetta di recupero permette di non sprecare il prodotto usato per la glassatura.
The bowl underneath collects the dripping product.

L'ampia base di lavoro consente la glassatura di prodotti con le più svariate forme e dimensioni.
Its large working base allows to glaze products of different shapes and dimensions.

È possibile glassare con diversi colori senza dover pulire la macchina ad ogni cambio di prodotto.
It is not necessary to clean the unit each time you change your glazing colour.

Una volta glassato il prodotto, si può intervenire con ulteriori decori senza levare i manufatti dalla glassatrice.
Once the product is glazed you can continue decorating without washing the machine.





POWER MILLS
Professional

LE PAVONI®

PLANETARIE ED IMPASTATRICI
PLANETARY MIXERS

POWER MIX PROFESSIONAL

cod: PMP

IN DOTAZIONE:
3 utensili in alluminio
INCLUDED:
3 aluminium tools



GUARDA IL VIDEO
WATCH THE VIDEO!



Impastatrice planetaria
professionale da banco 10 lt.
*Professional table-top planetary
mixer, 10 litres.*

- Robustezza e solidità.
- Variatore elettronico: consente una grande flessibilità nella scelta della velocità e nello stesso tempo un'estrema precisione nella regolazione della stessa.
- Le operazioni di aggancio/sgancio degli utensili sono estremamente facilitate dall'ampia corsa della vasca.
- Grande valore aggiunto di questa planetaria è dato dalla particolarità del sistema di ingranaggi, che consentono all'utensile di lavorare nella sua rotazione in 5 punti diversi della circonferenza della vasca al fine di ottenere un impasto omogeneo.
- La struttura della macchina è realizzata in acciaio inox AISI 304.
- *Robust and reliable.*
- *Electronic speed controller: ensures great flexibility in the choice of speeds and, at the same time, high precision speed control.*
- *Tool changeover operations are made easy by the wide range of movement of the bowl.*
- *Another great benefit of this planetary mixer lies in its unique gear system, which allows the tools to rotate touching 5 different points around the bowl and thereby achieving a homogeneous mixture.*
- *The machine body is made of AISI 304 stainless steel.*

3 utensili in alluminio in dotazione
Supplied with 3 aluminium tools

Frusta / Whisk

Uncino / Hook

Spatola / Blade



Vasca supplementare a richiesta
Additional bowl available on request

- 35 kg
- 750 Watt
- 220/240 volt
50/60 Hz
- da/from 40
a/up to 160
- 10 lt
- Garanzia 2 anni**
2 years guarantee

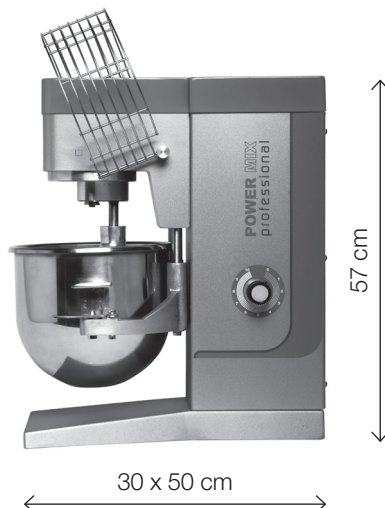

- Capacità di lavoro pari a 4 Kg di impasto.
Vasca realizzata in acciaio inox.
Motorizzazione con variatore di frequenza.
*4 Kg dough capacity.
Stainless steel column.
Engine with electronic frequency inverter.*

- Griglia di protezione della vasca.
Microinterruttore di sicurezza per arresto automatico.
*Protection guard.
Micro-switch for automatic stopping of tool.*

cod: PAVOMIX

IN DOTAZIONE:
3 utensili in alluminio
INCLUDED:
3 aluminium tools



Piccola ed efficiente.
Small and efficient.

3 utensili in alluminio in dotazione
Supplied with 3 aluminium tools

Frustra / Whisk

Gancio / Hook

Spatola / Blade



Vasca supplementare a richiesta
Additional bowl available on request



- La mescolatrice planetaria da banco Pavomix è una macchina professionale di estrema compattezza e solidità, realizzata in fusione di alluminio.
- Rappresenta l'ideale strumento di lavoro per qualsiasi cucina, luogo di ristorazione oppure per gelaterie, laboratori di pasticcerie, panifici e pizzerie. Indispensabile per tutti gli operatori professionali che pretendono la praticità abbinata alla funzionalità ed all'efficienza.
- *The Pavomix table-top planetary mixer is an extremely compact and reliable professional machine made of die-cast aluminium.*
- *It is the ideal work tool for any kitchen, catering site, ice cream parlour, pastry workshop, bakery or pizzeria, and indispensable for all food professionals in search of practicality as well as functionality and efficiency.*



Capacità di lavoro pari a 0,75 kg. d'impasto
Ribaltamento testa
Vasca in acciaio inox
Variatore elettronico di velocità
Pulsanti marcia/arresto
0,75 kg. dough capacity - Tilting of head
Bowl in stainless steel
Electronic variable speed - Stop/start buttons



Griglia protezione vasca
Microinterruttore di sicurezza per arresto automatico utensile
Conformità norme CE
Safety protection guard
Micro-switch for automatic stopping of tool
Conformity with CE norms



19 kg



500 Watt



220/240 volt
50/60 Hz



da/from 63
a/up to 235



6,5 lt



LE PAVONI®

FRANTUMATORI E MACINAPANE
CUTTER AND CRUSHERS BREAD

CUTTER



Pratici e semplici da usare.
Practical and easy to use.

- Formidabili tritatutto per preparare granella di nocciole, mandorle tritate e per la lavorazione di moltissimi prodotti di normale utilizzo in laboratorio.
- Ottime macchine per la preparazione di salse di frutta e verdura, gelatine di frutta e piccoli impasti.
- *Exceptional food processors for preparing ground hazelnuts and chopped almonds, and for processing an array of products normally used in the workshop.*
- *Excellent machines for preparing fruit or vegetable sauces, fruit jellies and small mixtures.*

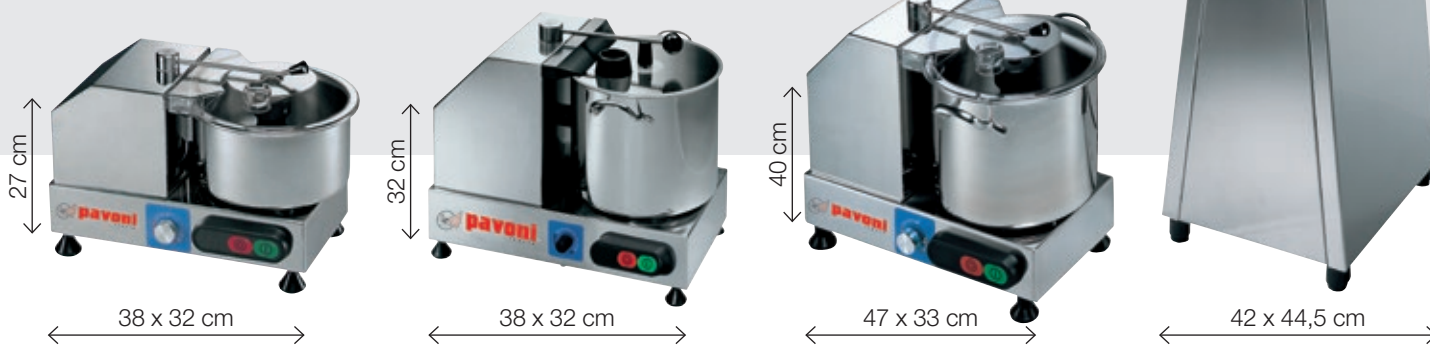

Cod: CUTTC4

Velocità / Speed
2600 g/m

Vasca / Bowl
lt 3,5

Motore / Engine
Hp 0,5

Cod: CUTTC6

Velocità / Speed
2600 g/m

Vasca / Bowl
lt 5,5

Motore / Engine
Hp 0,5

Cod: CUTTC9W

Velocità / Speed
1100-2600 g/m

Vasca / Bowl
lt 9

Motore / Engine
Hp 0,5

Cod: CUTTC15DV

Velocità / Speed
1400-2800 g/m

Vasca / Bowl
lt 15

Motore / Engine
Hp 2,2+3
2 velocità / speeds

Cod: CUTTC4W

Velocità / Speed
1100-2600 g/m

Vasca / Bowl
lt 3,5

Motore / Engine
Hp 0,5

Cod: CUTTC6W

Velocità / Speed
1100-2600 g/m

Vasca / Bowl
lt 5,5

Motore / Engine
Hp 0,5

LAME/BLADES

- 1 Lama di serie / Standard blade
- 2 Lama a richiesta / Blade on request
- 3 Lama a richiesta / Blade on request



TORNADOS

cod: TORNADOS

- Specifico per grattugiare pane secco, grissini, prodotti secchi da forno. Dotato di 4 filtri di scelta della granulometria.
- La tramoggia è dotata di due paratie inclinate e disassate e di un microinterruttore rispondente alle attuali norme di sicurezza.
- Interamente in acciaio inox nelle parti a contatto con il pane.
- *Specially designed for grinding dry bread, breadsticks and dry bakery products. Supplied with 4 sieves for different crumb sizes.*
- *The hopper is equipped with two sloping, offset walls and a microswitch that complies with current safety legislation.*
- *All parts that come into contact with the bread are made entirely of stainless steel.*

 25 kg

 750 Watt

 220/380 volt
50/60 Hz

 Motore trifase
Threephase motor
Hp 1

 Produzione oraria
Output per hour
100/120 kg/h



Macinapane.
Bread crusher.





Garanzia 2 anni
2 years guarantee

FPG 1200

cod: FPG1200

- Frantumatore per pane grosso che è in grado di frantumare pagnotte e filoni freschi o essiccati fino a 2,5 kg di peso.
- *Grinder for large bread products, able to grind fresh or dried loaves and batons up to 2.5 kg in weight.*

 280 kg

 4000 Watt

 220/380 volt
50/60 Hz

 Riduttore a vite senza
fine in bagno d'olio
*Adapter screw endless
adapter in oil bath*

 Motoriduttore /Adapter
Hp 5,5

 Produzione oraria
Output per hour
1000/2000 kg/h









Frantumatore per pane grosso.
Grinder for large bread products.



Garanzia 2 anni
2 years guarantee

cod: SG

- Questo macinapane industriale è nato per la macinazione di grandi quantità di prodotti secchi da forno (pane, grissini, biscotteria).
- *This industrial bread grinder was developed to grind large quantities of dry bakery products (bread, breadsticks, biscuits).*

	280 kg
	4000 Watt
	220/380 volt 50/60 Hz
	Motore trifase Threephase motor Hp 5,5
	Produzione oraria Output per hour 400/450 kg/h
	97x70
	H 75 cm Bocca di scarico Of discharge outlets

Capacità di carico 35 kg.
Possibilità di alimentazione automatica con lo specifico caricatore a nastro.
*Load capacity: 35 kg
Automatic conveyor belt loading option.*



Macinapane industriale per grandi quantità.
Industrial bread grinder for large quantities.







Garanzia 2 anni
2 years guarantee

SUPERGHIBLI

cod: SUPERGHIBLI

- Per la macinazione di pane secco e di tutti i prodotti secchi da forno.
- Tramoggia di carico e camera di macinazione in acciaio inox.
- La tramoggia di carico è dotata di un cono di protezione per le norme antifuoristrada.
- Dotato di tre filtri per la scelta della granulometria.
- *For grinding dry bread and all dry bakery products.*
- *Loading hopper and grinding chamber made of stainless steel.*
- *Loading hopper is equipped with a safety cone for compliance to accident-prevention legislation.*
- *Equipped with 3 sieves for different crumb sizes.*

	80 kg
	2200 Watt
	220/380 volt 50/60 Hz
	Motore trifase Threephase motor Hp 3,0
	Produzione oraria Output per hour 250/300 kg/h



Macinatore per pane.
Bread crumber.



Garanzia 2 anni
2 years guarantee

LE PAVONI®

ALTRE MACCHINE
OTHERS MACHINES

cod: ROLLERBISCUIT

KG 9 kg

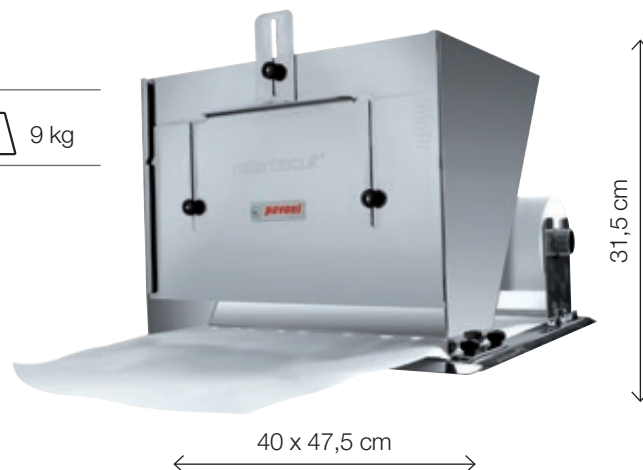

Lo strumento ideale per stendere tutti i tipi di biscuit.

The ideal tool for rolling out all types of biscuits.

- Rollerbiscuit è uno strumento studiato per permettere di stendere tutti i tipi di biscuit e/o masse di pari densità con una velocità ed una precisione davvero uniche.
- I vantaggi che si ottengono con l'impiego di Rollerbiscuit sono numerosi: nella stesura del biscuit si impiega circa 1/4 del tempo normalmente impiegato con il metodo tradizionale, a tutto vantaggio della qualità del prodotto.
- Il prodotto ottenuto è estremamente regolare sia in altezza sia in larghezza e di conseguenza anche in cottura.
- Si stendono biscuit adatti ad ogni tipo di utilizzo ma soprattutto per la preparazione di mignon da taglio e di tronchetti.
- Il funzionamento è totalmente meccanico.
- Rollerbiscuit dispone di pratiche tacche di regolazione per l'altezza del biscuit.
- Un regolatore centrale permette di memorizzare il livello selezionato in modo da poter chiudere lo sportello (e di riportarlo velocemente all'altezza desiderata) quando si smette di tirare il foglio di carta da forno e si posiziona il biscuit sulle teglie.
- Rollerbiscuit è costruito interamente in acciaio inox, è facilmente smontabile e può essere lavato in lavastoviglie.

- *Rollerbiscuit has been designed to roll out all types of biscuits and/or solids of similar density with truly unique accuracy and speed.*
- *The benefits of Rollerbiscuit are numerous: rolling takes a quarter of the time normally required when using traditional methods; product quality is also improved.*
- *The product created is extremely uniform in terms of both thickness and width, and as a result cooks more evenly too.*
- *Rollerbiscuit rolls out all types of biscuits, but is particularly suited to the preparation of mignons and logs.*
- *Its operation is fully mechanical.*
- *Rollerbiscuit features useful markings for adjusting biscuit thickness.*
- *A central control memorizes the level selected so that the door can be closed (and brought rapidly to the width required) once the sheet of baking paper has been pulled out and the biscuits are placed on trays.*
- *Rollerbiscuit is made entirely of stainless steel and is easily dismantled for washing in a dishwasher.*



Cod: RR200

Rotolo di carta da forno fornito a parte.
Roll of baking paper supplied separately.

DIM: 200 m x 40 cm

L'utilizzo di ROLLERBISCUIT richiede un solo operatore ed è estremamente facile ed immediato.
ROLLERBISCUIT requires only one operator and is extremely practical and easy to use.

- 1 Rovesciare la montata di biscuit nella tramoggia.
Pour the biscuit dough into the hopper.



- 2 Posizionare lo sportello all'altezza desiderata.
Position the door at the height required.



- 3 Tirare la carta per tutta la lunghezza del piano di lavoro.
Pull the paper out to cover the length of the work top.



- 4 Con l'aiuto di un bisturi tagliare il foglio della stessa lunghezza della teglia.
With the aid of a knife cut a sheet the same length as the tray.



SPIATTINA

cod: SPIATTINA

La soluzione ideale per preparare e servire al momento ogni tipo di piatto.
The ideal solution for preparing and serving every type of dish in an instant.

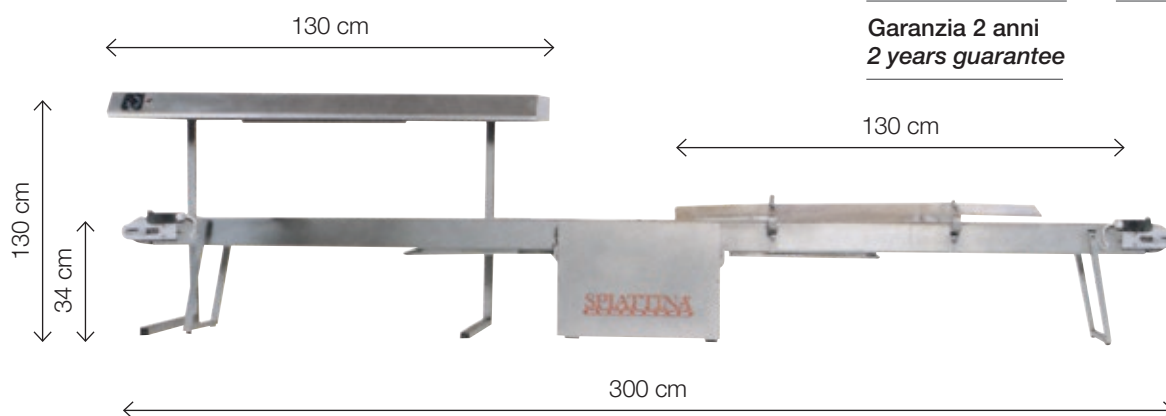

 70 kg

 150 Watt

 220/240 volt
50-60 Hz
A richiesta / On demand
110 volt
50-60 Hz

**Garanzia 2 anni
2 years guarantee**

LAMPADA / LAMP
Cod: LAMPADA SPIATTINA

DIM. cm 130 x 40 x 15 H

 16 kg

 1200 Watt

 220 volt



65 x 50 cm (chiusa/closed)
50 x 300 cm (aperta/open)
50 x 30 x h 130 cm
(aperta con lampada/open with lamp)

- Spiattina permette di ottimizzare gli intervalli di tempo tra la preparazione dei piatti e il servizio in tavola, oltre a ridurre gli ingombri su carrelli portapiatti, tavoli, celle, etc.
- *Spiattina minimizes the time taken between preparing a dish and serving it at the table, as well as reducing the quantity of items on trolleys, tables and food warmers, etc.*

PELAMELE

cod: PELAMELE

Fruit peeler.

- Veloce, facile da usare, evita sprechi di materiale.
- Il frutto viene sbucciato, tagliato a fette e il torsolo tolto; resta quindi pronto per essere utilizzato a piacere.
- Movimento meccanico.
- *Quick, easy to use, avoids waste.*
- *The fruit is peeled, cored and sliced ready for use as required.*
- *Mechanically operated.*

 6,15 kg



MANDAPASTA

cod: FV400

Per filoni di pasta
da 400 mm
For 400 mm dough

cod: FV500

Per filoni di pasta
da 500 mm
For 500 mm dough

Ideale per formare filoni di pasta aventi un peso compreso tra i 5 e i 35 Kg.
Ideal for making dough with weights of between 5 and 35 kg.

- Questa macchina è stata studiata appositamente per formare con precisione filoni di pasta di un peso compreso tra i 5 kg ed i 35 kg.
- *This machine has been specially designed to accurately make dough with weights of between 5 kg and 35 kg.*

 350 kg

 750 Watt

 380 volt
50-60 Hz

Garanzia 2 anni
2 years guarantee

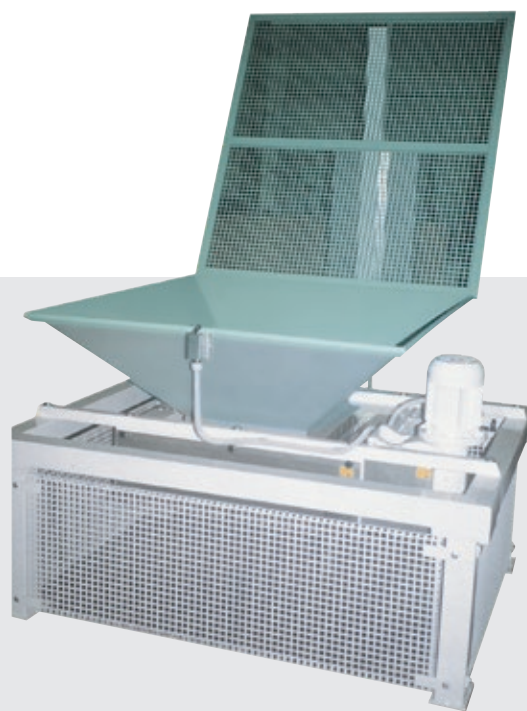
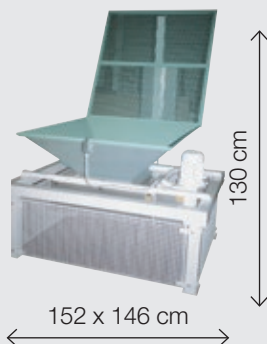

VEGA

cod: VEGA

Per riempire automaticamente sacchetti preformati.
For automatically filling preformed bags.

- Questa macchina è studiata per il riempimento automatico di sacchetti preformati, in materiale plastico termosaldabile, con dosaggi compresi tra 100 gr e 400 gr di prodotto.
- Adatta per pane grattugiato e prodotti sfarinati granulari.
- *This machine has been designed to automatically fill preformed heat-seal plastic bags with quantities of between 100 g and 400 g of product.*
- *Suitable for breadcrumbs and crumbed flour products.*



Garanzia 2 anni
2 years guarantee

 30 kg

 120 Watt

 220/380 volt
60 Hz

A richiesta / *On demand*
220 volt
50 Hz

 Motore trifase /
Threephase motor
Hp 0,12

Cod: SIGILLATRICE

SIGILLATRICE/SEALER
Dim. 340 x 270 mm
H 273 mm



Cod: TAVOLO C/S

Dim. 425 x 559 mm
H 343
Acciaio inox
Stainless steel



DECOBASSINA

cod: DECOBASSINA

Per tostare la frutta secca.
For toasting dried fruit.

- Macchina per la realizzazione di prodotti pralinati, zucchero caramellato di mandorle, arachidi, noci e nocciole, frutta secca, ricoperti di gianduia o cioccolato, e altre specialità per confetteria.
- *Machine for preparing pralines, sugar-coated almonds, peanuts, walnuts and hazelnuts, candied fruit, gianduia- or chocolate-covered fruit and other confectionary specialities.*



 32 kg

 170 Watt

 220 volt
50-60 Hz

 Capacità di lavorazione /
Production capacity
da/from 2 a/up to 8 Kg

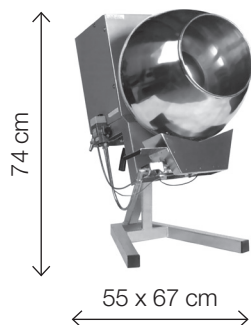

Disponibile con attacco a metano o a gas
Available with methan or propan gas
Telaio di ferro zincato / *Zinc-plated iron frame*
Contenitore in rame / *Copper basin*

MICROONDE

Forni digitali a microonde.
Digital microwave ovens.

- Forni digitali, in acciaio inox, con piano in vetroceramica sigillato
- 20 memorie programmabili e 10 livelli di cottura. Timer da 60 minuti.
- Raffreddamento automatico dei componenti elettrici.
- Sistema di distribuzione delle microonde ad antenna rotante con due magnetron per i modelli MASTER 1400D e MASTER 1800D.
- *Stainless steel, digital microwave ovens with a sealed glass-ceramic chamber base*
- *20 programmable settings and 10 cooking power levels. 60-minute timer.*
- *Automatic cooling of electrical components.*
- *Rotating antenna microwave distribution system with two magnetrons on the MASTER 1400D and MASTER 1800D models.*



 17 lt

 230 volt

Cod: MASTER 1000D

 1000 Watt

Cod: MASTER 1400D

 1400 Watt

Cod: MASTER 1800D

 1800 Watt

dim. esterne / *external dim.*
425 x 564 mm, H 343
dim. interne / *internal dim.*
330 x 305 mm, H 175

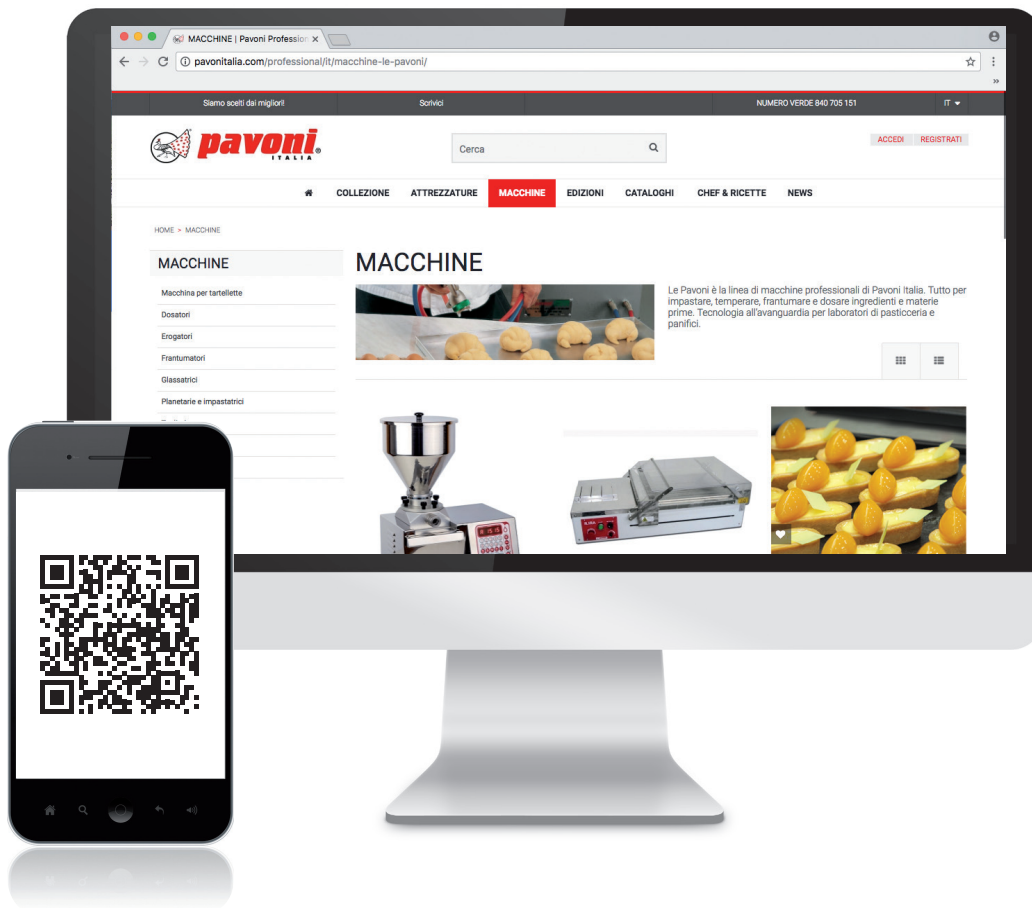

Il sito www.pavonitalia.com, nella sezione Professional, si propone come guida per i nostri clienti e per chiunque desideri entrare a contatto con la realtà Pavoni.



The website www.pavonitalia.com, in the Professional section, has the purpose to become a guide for our customers and for anybody wants to get in touch with Pavoni reality.

Potete contattarci direttamente su Facebook Messenger.

Contact us directly through Facebook Messenger.



<https://www.facebook.com/PavoniProfessional>
<http://www.youtube.com/PAVONITALIASPA>
<http://instagram.com/pavonitalia>
<https://twitter.com/pavonitalia>
<http://it.pinterest.com/pavonitalia/>



PAVONI ITALIA S.P.A. | VIA E. FERMI, S.N.
 24040 SUISIO BG ITALIA
 TEL. + 39 035 49 34 111 | FAX +39 035 49 48 200
 INFO@PAVONITALIA.COM | WWW.PAVONITALIA.COM





Pavoni Italia S.p.A.

via E. Fermi, s.n. - 24040 Suisio BG Italia

Tel. + 39 035 49 34 111 - Fax +39 035 49 48 200

info@pavonitalia.com

www.pavonitalia.com